

Compact cylinder, double-acting ADN-S

FESTO



Characteristics

At a glance

Further information → [adn-s](#)

- Very compact design: shorter than comparable cylinders
- Reduced housing length: saving materials and weight
- Reduced housing width: for space-critical applications
- Large selection: standard strokes 5 ... 50 mm
- Design by Festo: visually compelling

Product segmentation



Festo Core Range

Solves the majority of your automation tasks

With the Festo Core Range, we have selected the most important products and functions from our broad product catalogue, and added the quickest delivery. The Core Range offers you the best value with the expected high Festo quality.

- Quickest delivery, worldwide – wherever, whenever
- Expected high Festo quality
- Easy and fast to select

Diagrams

Further information → [adn-s](#)



The diagrams shown in this document are also available online. These can be used to display precise values.

Design type

[S] Short

Particularly suitable for applications where space is critical

Piston rod thread type

[A] Male thread



[I] Female thread



Cushioning

[P] Elastic cushioning rings/plates on both sides

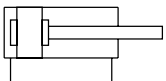

The drive is fitted with elastic polymer end-position cushioning.

Benefits:

- No adjustment required
- Saves time

Position sensing

[A] For proximity sensor

By using proximity switches, any position can be detected.

Characteristics

Special material properties

[F1A] Recommended for production facilities for the manufacture of lithium-ion batteries

Product:

Metals with more than 1% copper, zinc or nickel by mass are excluded from use. Exceptions are nickel in steel, chemically nickel-plated surfaces, circuit boards, cables, electrical plug connectors and coils

Accessories:

Please contact your Festo representative for information on which accessories are suitable for manufacturing lithium-ion batteries

Application example

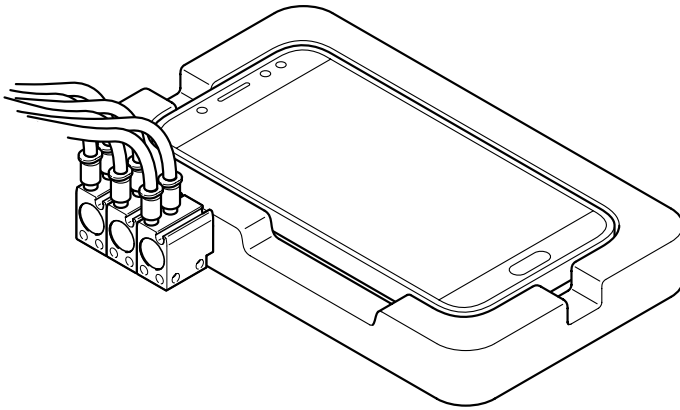

- Endurance testing of smartphone buttons

Compact cylinder, double-acting ADN-S

Type code

001	Series
ADN-S	Compact cylinder, double-acting

002	Design type
S	Short

003	Piston diameter [mm]
6	6
10	10
12	12
16	16
20	20
25	25
32	32
40	40
50	50
63	63

004	Stroke [mm]
5	5
10	10
15	15
20	20
25	25
30	30
35	35
40	40
45	45
50	50

005	Piston rod thread type
A	Male thread
I	Female thread

006	Cushioning
	No cushioning
P	Elastic cushioning rings/plates on both sides

007	Position sensing
	None
A	For proximity sensor

008	Special material properties
	None
F1A	Recommended for production facilities for the manufacture of lithium-ion batteries

Datasheet

Operating and environmental conditions										
Piston diameter	6 mm	10 mm	12 mm	16 mm	20 mm	25 mm	32 mm	40 mm	50 mm	63 mm
Operating pressure ¹⁾	0.2 ... 0.8 MPa	0.1 ... 0.8 MPa	0.1 ... 1 MPa		0.06 ... 1 MPa			0.04 ... 1 MPa		
Operating pressure ²⁾	2 ... 8 bar	1 ... 8 bar	1 ... 10 bar		0.6 ... 10 bar			0.4 ... 10 bar		
Operating pressure ³⁾	21.75 ... 116 psi	14.5 ... 116 psi	14.5 ... 145 psi		8.7 ... 145 psi			5.8 ... 145 psi		
Operating medium	Compressed air to ISO 8573-1:2010 [7:4:4]									
Note on operating and pilot medium	Lubricated operation possible (in which case lubricated operation will always be required)									
Ambient temperature ⁴⁾	-10 ... 60°C		0 ... 60°C							
Corrosion resistance class CRC ⁵⁾	1 - Low corrosion stress 2 - Moderate corrosion stress						0 - No corrosion stress 1 - Low corrosion stress 2 - Moderate corrosion stress			

1) The minimum pressure values in the retracting direction may be slightly higher after an extended idle time.

2) The minimum pressure values in the retracting direction may be slightly higher after an extended idle time.

3) The minimum pressure values in the retracting direction may be slightly higher after an extended idle time.

4) Note the operating range of the proximity switches.

5) Corrosion resistance class for each individual type → Ordering information. More information www.festo.com/x/topic/kbk

Forces										
Piston diameter	6 mm	10 mm	12 mm	16 mm	20 mm	25 mm	32 mm	40 mm	50 mm	63 mm
Theoretical force at 0.6 MPa (6 bar, 87 psi), advance stroke	17 N	47 N	68 N	121 N	188 N	295 N	483 N	754 N	1,178 N	1,870 N
Theoretical force at 0.6 MPa (6 bar, 87 psi), return stroke	9.4 N	30.2 N	51 N	90 N	141 N	247 N	415 N	686 N	1,057 N	1,750 N

Impact energy without position sensing							
Piston diameter	6 mm	10 mm	12 mm	16 mm	20 mm	25 mm	32 mm
Impact energy in end positions	0.006 J	0.012 J	0.06 J	0.1 J	0.14 J	0.18 J	0.26 J

Impact energy with position sensing										
Piston diameter	6 mm	10 mm	12 mm	16 mm	20 mm	25 mm	32 mm	40 mm	50 mm	63 mm
Impact energy in end positions	0.006 J	0.012 J	0.07 J	0.15 J	0.2 J	0.3 J	0.4 J	0.7 J	1 J	1.3 J

Weight without position sensing for Ø 6 ... 10 mm						
Piston diameter	6 mm			10 mm		
Stroke	5 mm		10 mm	5 mm		10 mm
Product weight	9.2 g		11.9 ... 15 g	12.2 ... 17 g		15.4 ... 19 g
Moving mass	1.5 g		2.3 g	4.1 g		5.3 g

Weight with position sensing for Ø 6 ... 10 mm						
Piston diameter	6 mm			10 mm		
Stroke	5 mm		10 mm	5 mm		10 mm
Product weight	10.9 g		13.6 ... 15 g	14.5 ... 17 g		17.7 ... 19 g
Moving mass	1.6 g		2.4 g	4.5 g		5.7 g

Weight without position detection for Ø 12 ... 63 mm						
Piston diameter	12 mm		16 mm	20 mm	25 mm	32 mm
Basic weight for 0 mm stroke	26 g		32.5 g	51 g	70 g	107 g
Additional weight per 10 mm stroke	15 g		18 g	26 g	30 g	36 g
Moving mass for 0 mm stroke	3.5 g		6 g	11 g	17 g	31 g
Additional moving mass per 10 mm stroke	2 g		4 g	6 g		9 g

Datasheet

Weight with position sensing for \varnothing 12 ... 63 mm

Piston diameter	12 mm	16 mm	20 mm	25 mm	32 mm	40 mm	50 mm	63 mm
Basic weight for 0 mm stroke	33 g	42 g	65 g	88 g	117 g	304 g	324 g	499 g
Additional weight per 10 mm stroke	15 g	18 g	26 g	30 g	36 g	45 g	63 g	77 g
Moving mass for 0 mm stroke	6 g	11 g	18 g	25 g	37 g	62 g	104 g	151 g
Additional moving mass per 10 mm stroke	2 g	4 g	6 g		9 g		16 g	

Max. transverse force F_q as a function of cantilever load l

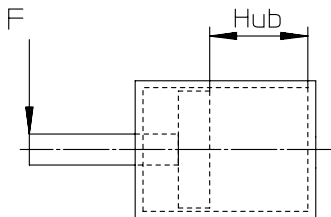

The piston \varnothing 6 ... 10 must not be subjected to transverse forces. More information
 → www.festo.com User documentation.

Max. transverse force F_q as a function of cantilever load l – without sensing

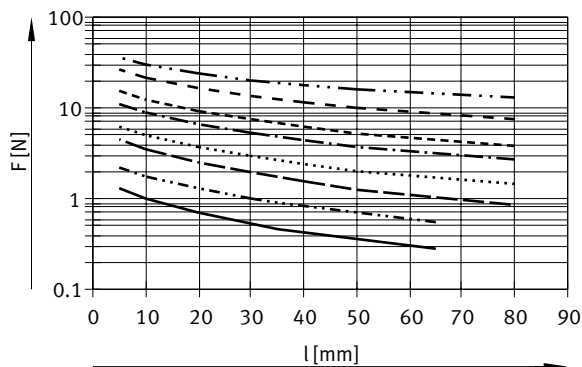

- ADN-S-12
- - - ADN-S-16
- · - · ADN-S-20
- · · · · ADN-S-25
- · - · ADN-S-32
- - - · ADN-S-40
- · - · ADN-S-50
- · - · ADN-S-63

Datasheet

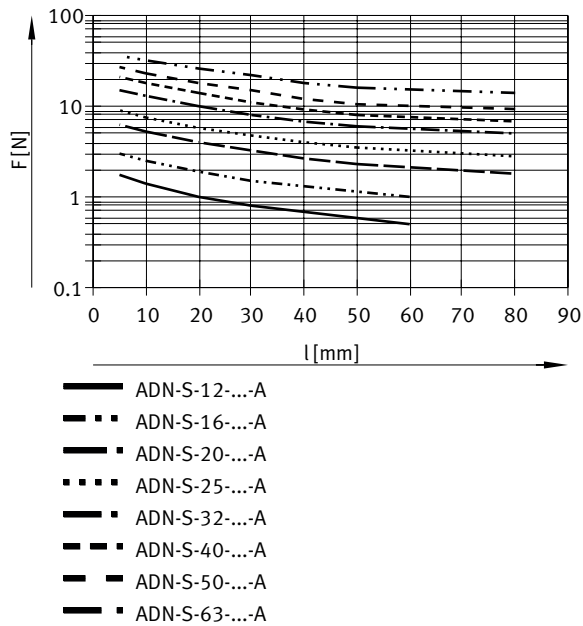
Max. transverse force F_q as a function of cantilever load l – with sensing

Materials

Piston diameter	6 mm	10 mm	12 mm	16 mm	20 mm	25 mm	32 mm	40 mm	50 mm	63 mm
Material housing	Wrought aluminium alloy Anodised wrought aluminium alloy Anodised		Anodised wrought aluminium alloy							
Material cover	Wrought aluminium alloy		Anodised wrought aluminium alloy							
Material piston rod	High-alloy stainless steel									
Material dynamic seals	NBR TPE-U(PU)							TPE-U(PU)		
Note on materials	RoHS-compliant									
LABS (PWIS) conformity	VDMA24364-B2-L									
Cleanroom class	Class 6 according to ISO 14644-1									
Suitability for the production of Li-ion batteries	Metals with more than 1% by mass of copper, zinc or nickel are excluded from use. Exceptions are nickel in steel, chemically nickel-plated surfaces, printed circuit boards, cables, electrical plug connectors and coils									

Dimensions

Dimensions – Ø 6 ... 10 mm – with female thread

Download CAD data → www.festo.com

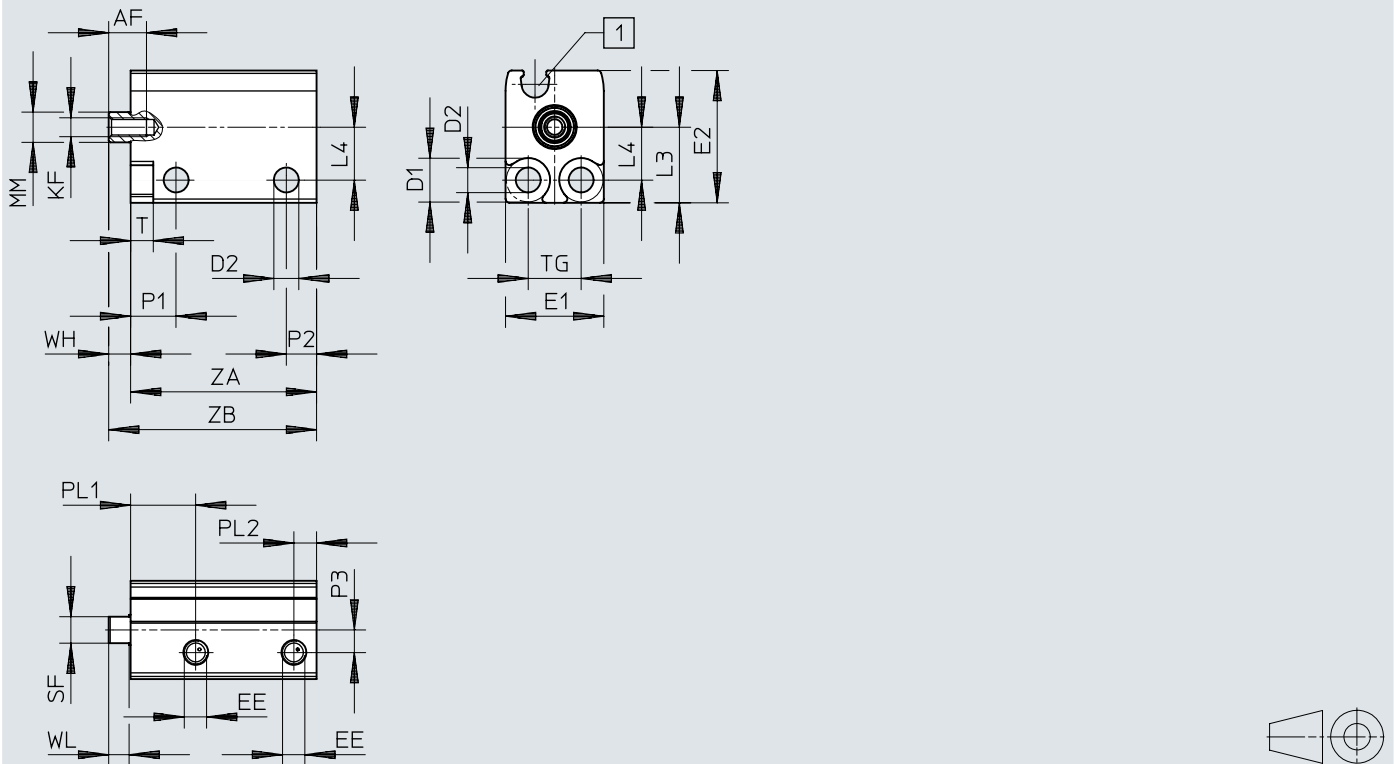

[1] C-slot for proximity switch

	AF	D1 Ø H13	D2 Ø	EE	E1 max.	E2 max.	KF	L3	L4	MM Ø
ADN-S-6	5	5,8	3,3	M3	13	17,5	M2,5	10	7	4
ADN-S-10	6				13,5	20,5	M3	11	8	6

	P1	P2	P3	PL2	SF	T	TG ±0,1	WH	WL
ADN-S-6	6	4	3	3	3,5	3	7	3	2,7
ADN-S-10			3,2		5				

	L ¹⁾ [mm]	2)	PL1	ZA +0,3	ZB ±0,35
ADN-S-6	5	–	8,6	20,5	23,5
		■	8,6	24,5	27,5
	10	–	8,6	25,5	28,5
		■	8,6	29,5	32,5
ADN-S-10	5	–	9,2	20,5	23,5
		■	9,9	24,5	27,5
	10	–	9,2	25,5	28,5
		■	9,9	29,5	32,5

- 1) Stroke
- 2) Position sensing

Dimensions

Dimensions – Ø 6 ... 10 mm – With male thread

Download CAD data → www.festo.com

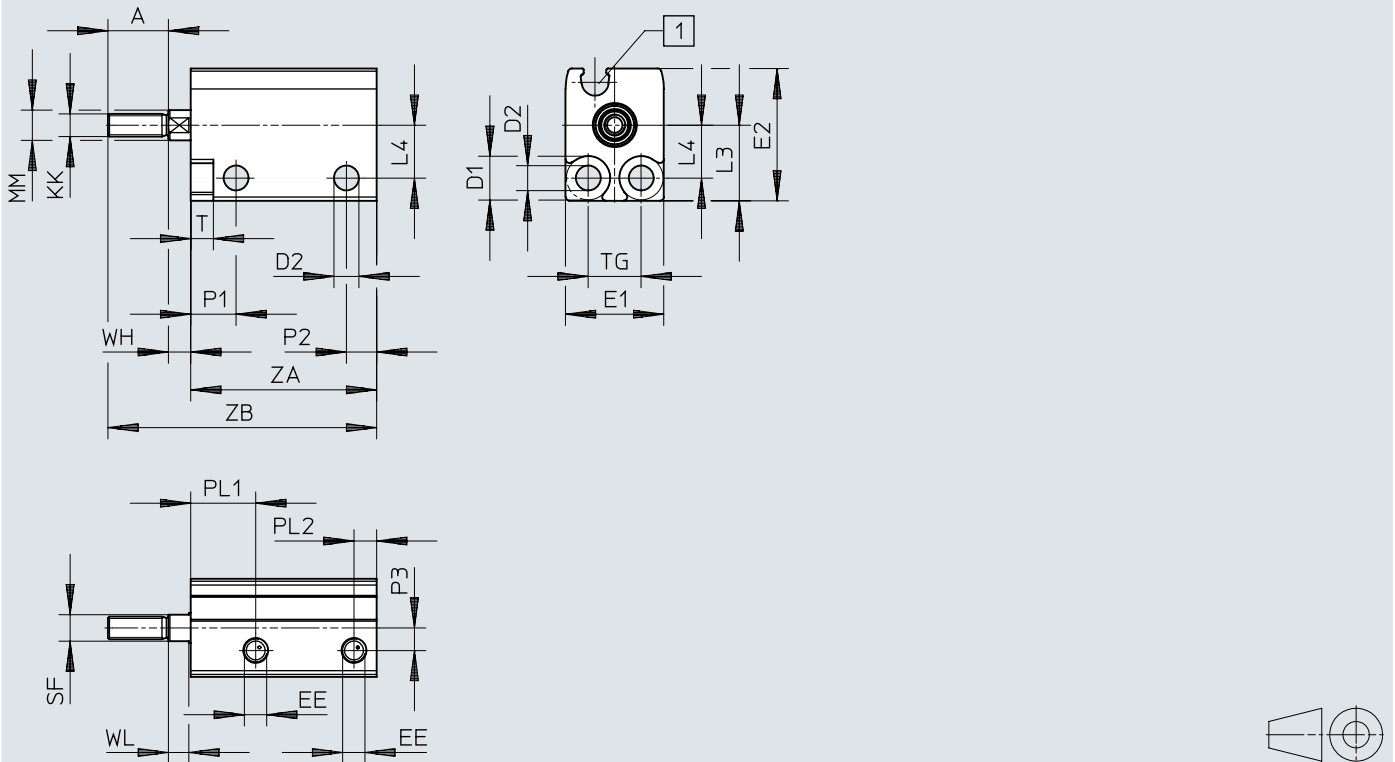

[1] C-slot for proximity switch

	A	D1 Ø H13	D2 Ø	EE	E1 max.	E2 max.	KK	L3	L4	MM Ø
ADN-S-6	8	5,8	3,3	M3	13	17,5	M3	10	7	4
ADN-S-10	10				13,5	20,5	M4	11	8	6

	P1	P2	P3	PL2	SF	T	TG ±0,1	WH	WL
ADN-S-6	6	4	3	3	3,5	3	7	3	2,7
ADN-S 10			3,2		5				

	L ¹⁾ [mm]	2)	PL1	ZA +0,3	ZB ±0,35
ADN-S 6	5	–	8,6	20,5	31,5
		■	8,6	24,5	35,5
	10	–	8,6	25,5	36,5
ADN-S 10	5	–	9,2	20,5	33,5
		■	9,9	24,5	37,5
	10	–	9,2	25,5	38,5
		■	9,9	29,5	42,5

- 1) Stroke
- 2) Position sensing

Dimensions

Dimensions – Ø 12 ... 63 mm – with female thread

Download CAD data → www.festo.com

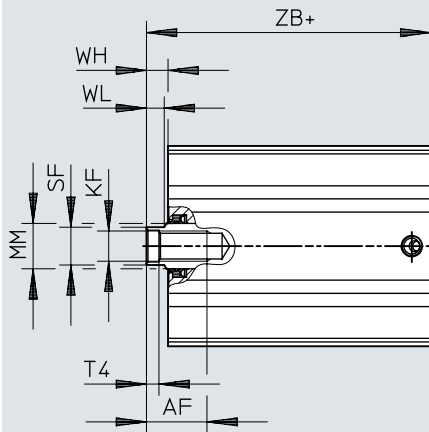

[1] += plus stroke length

	AF min.	KF	MM Ø h8	SF h13	T4	WH +1	WL -0,15	ZB	
								+1,2	¹⁾ +1,2
ADN-S-12	8	M3	6	5	1,5	2,5	2,7	18	22
ADN-S-16	10	M4	8	7	1,5	3	3,5	19	23,5
ADN-S-20	11	M6	10	9	2,6	3	4	20,5	25
ADN-S-25	11	M6	10	9	2,6	3,5	4,2	22,5	27
ADN-S-32	12	M8	12	10	3,3	4	4,7	25,5	29
ADN-S-40	16	M8	12	10	3,3	5	4,7	–	34,5
ADN-S-50	16	M10	16	13	4,7	7	6,5	–	39
ADN-S-63	20	M10	16	13	4,7	7	6,5	–	42

1) Position sensing

Dimensions

Dimensions – Ø 12 ... 63 mm – with male thread

Download CAD data → www.festo.com

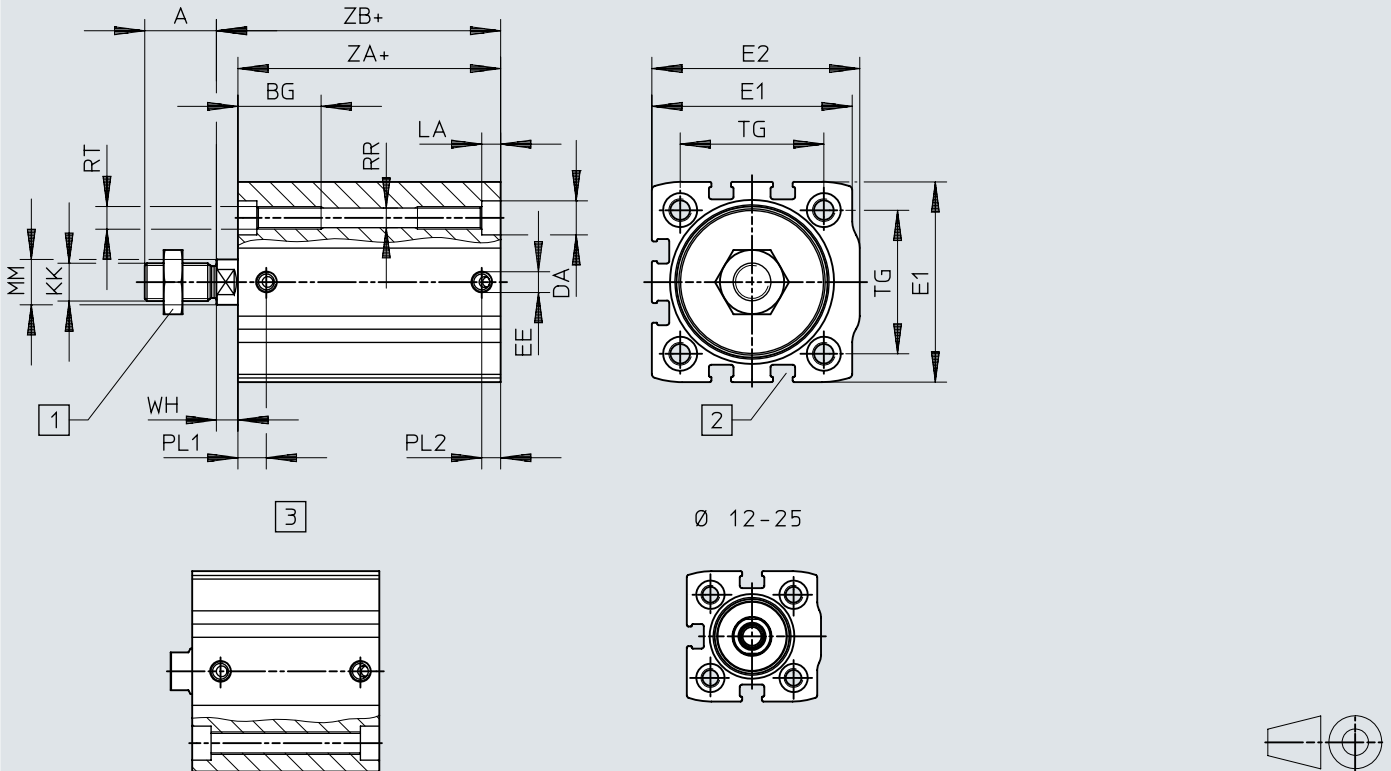

- [1] Hex nut DIN 439-B only from Ø 32
- [2] T-slot for proximity switch
- [3] Continuous thread Ø 12 ... 25: ZA 0 ... 40, Ø 32 ... 63: ZA 0 ... 50
- [4] + = plus stroke length

	A	BG	DA Ø F9	E1	E2	EE	KK	LA ±0,1	MM Ø h8	PL1
	-0,5	min.								
ADN-S-12	10	19	6	27 _{+0,15}	27,5 _{+0,15}	M5	M5	3,5	6	5
ADN-S-16	12	19	6	29 _{+0,15}	30 _{+0,15}	M5	M6	3,5	8	6
ADN-S-20	16	20	7,5	34,5 _{+0,15}	35,5 _{+0,15}	M5	M8	5	10	6
ADN-S-25	16	20	7,5	38,5 _{+0,15}	39,5 _{+0,15}	M5	M8	5	10	5,5
ADN-S-32	19	22	9	45 _{+0,15}	47 _{+0,15}	M5	M10x1,25	5	12	6,1
ADN-S-40	19	22	9	53 _{+0,15}	55 _{+0,15}	M5	M10x1,25	5	12	7,5
ADN-S-50	22	23	11	63 _{+0,2}	66 _{+0,2}	G1/8	M12x1,25	5	16	8,2
ADN-S-63	22	23	11	75 _{+0,2}	78,5 _{+0,2}	G1/8	M12x1,25	5	16	8,5

	PL2	RR Ø	RT	TG	WH +1	ZA		ZB	
						+0,2	¹⁾ +0,2	+1,2	¹⁾ +1,2
ADN-S-12	5	3,5	M4	16	2,5	15,5	19,5	18	22
ADN-S-16	5	3,5	M4	18	3	16	20,5	19	23,5
ADN-S-20	5	4,2	M5	22	3	17,5	22	20,5	25
ADN-S-25	5	4,2	M5	26	3,5	19	23,5	22,5	27
ADN-S-32	5	5,2	M6	32,5	4	21,5	25	25,5	29
ADN-S-40	5	5,2	M6	38	5	–	29,5	–	34,5
ADN-S-50	7,5	6,8	M8	46,5	7	–	32	–	39
ADN-S-63	8	6,8	M8	56,5	7	–	35	–	42

1) Position sensing

Dimensions

Dimensions – Foot mounting HNA

Download CAD data → www.festo.com

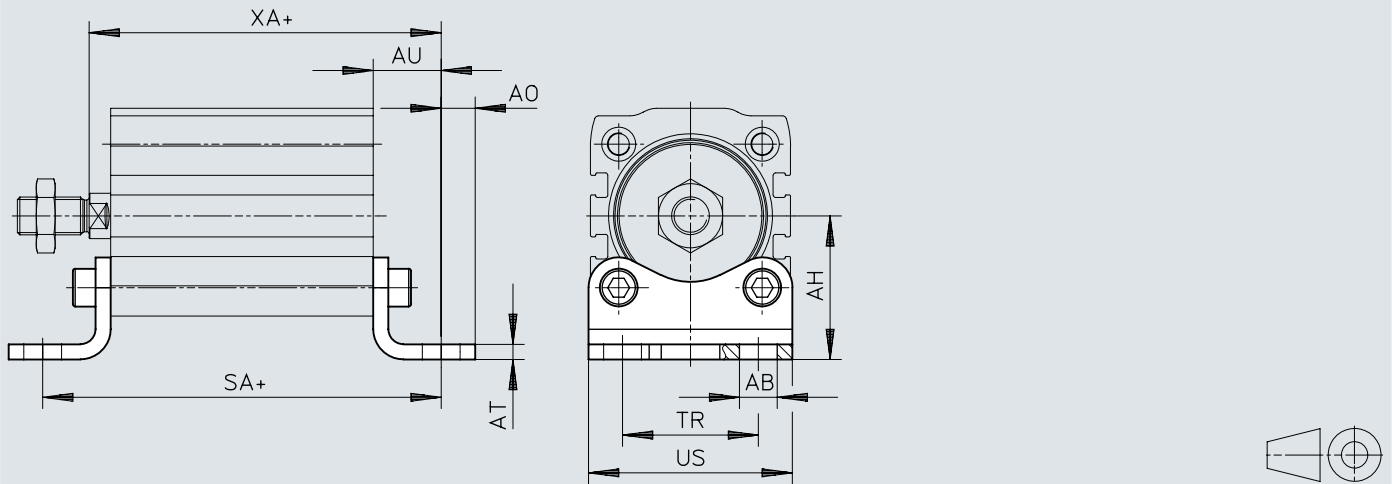

[1] += plus stroke length

	AB	AH	AO	AT	AU	SA ³⁾		TR	US	XA ³⁾	
	∅						²⁾			²⁾	²⁾
	H14	JS14		±0,5	±0,2	+0,2	+0,2	±0,2	-0,5	+1,2	+1,2
HNA-12	5,8	21	5	3	13	41,5	45,5	16	26	31	35
HNA-16	5,8	22	4,75	3	13	42	46,5	18	27,5	32	36,5
HNA-20	7	27	6,25	4	16	49,5	54	22	34,5	36,5	41
HNA-25	7	29	6,25	4	16	51	55,5	26	38,5	38,5	43
HNA-32	7	33,5	7	4	16	53,5	57	32	46	41,5	45
HNA-40	10	38	9	4	18	62	65,5	36	54	49	52,5
HNA-50	10	45	8	5	21	71	74	45	64	57	60
HNA-63	10	50	8	5	21	74	77	50	75	60	63

2) Position sensing

3) Deviating dimensions for the strokes 5, 10 and 25

Dimensions

Dimensions – Foot mounting HNA

Download CAD data → www.festo.com

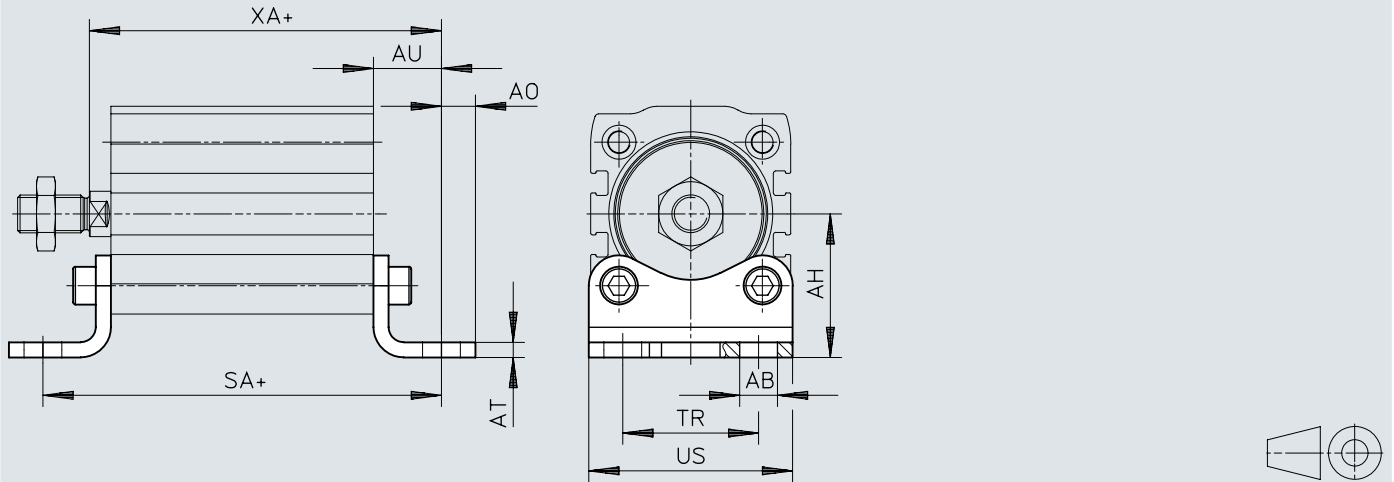

[1] += plus stroke length

Dimensions

	L ¹⁾ [mm]	2)	SA +0,2	XA +1,2
HNA-12	5	–	46,5	36
		■	50,5	40
	10	–	51,5	41
		■	55,5	45
HNA-16	5	–	47	37
		■	51,5	41,5
	10	–	52	42
		■	56,5	46,5
	25	–	69	59
		■	74,5	64,5
HNA-20	5	–	54,5	41,5
		■	59	46
	10	–	59,5	46,5
		■	64	51
	25	–	77,5	64,5
		■	82	69
HNA-25	5	–	56	43,5
		■	60,5	48
	10	–	61	48,5
		■	65,5	53
	25	–	79	66,5
		■	83,5	71
HNA-32	5	–	58,5	46,5
		■	62	50
	10	–	63,5	51,5
		■	67	55
	25	–	81,5	69,5
		■	85	73
HNA-40	5	–	67	54
		■	70,5	57,5
	10	–	72	59
		■	75,5	62,5
	25	–	90	77
		■	93,5	80,5
HNA-50	10	–	81	67
		■	84	70
	25	–	98,5	84,5
		■	102	88
HNA-63	10	–	84	70
		■	87	73
	25	–	101,5	87,5
		■	104,5	90,5

1) Stroke

2) Position sensing

Dimensions

Dimensions – Flange mounting FNC

Download CAD data → www.festo.com

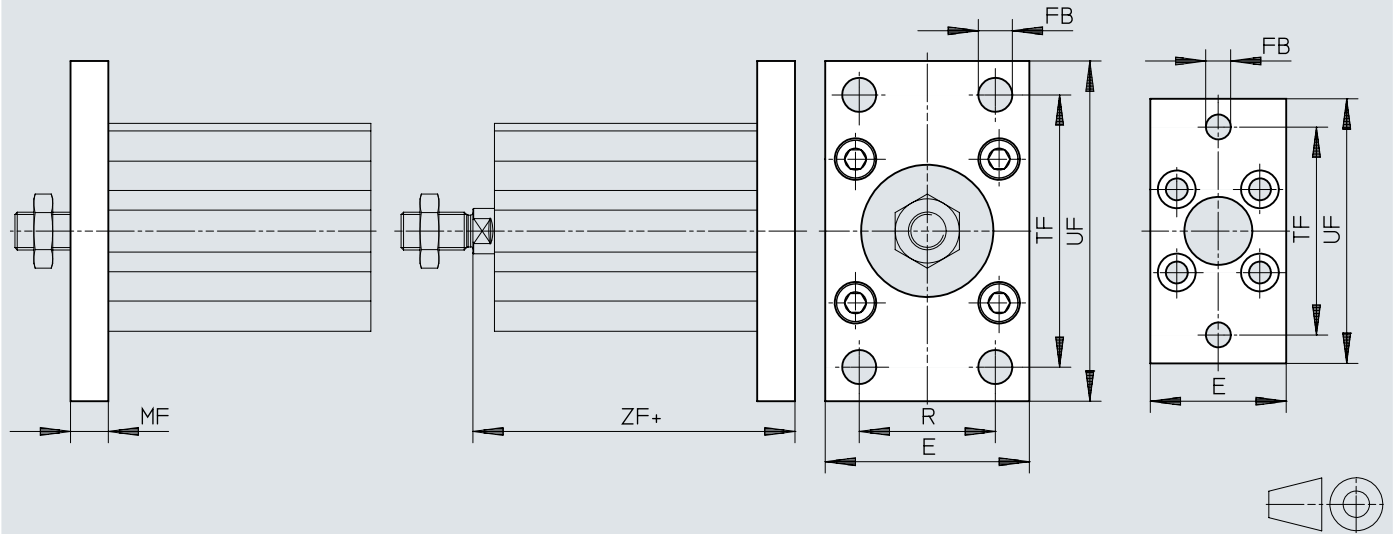

[1] + = plus stroke length

Dimensions

	E	FB ∅	MF	R	TF	UF ±1	ZF	
							+0,2	²⁾ +0,2
FNC-12	28	5,5	8	–	40	50	26	30
FNC-16	29	5,5	8	–	43	55	27	31,5
FNC-20	36	6,6	8	–	55	70	28,5	33
FNC-25	40	6,6	8	–	60	76	30,5	35
FNC-32	45	7	10	32	64	80	35,5	39
FNC-40	54	9	10	36	72	90	41	44,5
FNC-50	65	9	12	45	90	110	48	51
FNC-63	75	9	12	50	100	120	51	54

	L ¹⁾ [mm]	²⁾	ZF +0,2
FNC-12	5	–	31
		■	35
	10	–	36
		■	40
FNC-16	5	–	32
		■	36,5
	10	–	37
		■	41,5
	25	–	54
		■	59,5
FNC-20	5	–	33,5
		■	38
	10	–	38,5
		■	43
	25	–	56,5
		■	61
FNC-25	5	–	35,5
		■	40
	10	–	40,5
		■	45
	25	–	58,5
		■	63
FNC-32	5	–	40,5
		■	44
	10	–	45,5
		■	49
	25	–	63,5
		■	67
FNC-40	5	–	46
		■	49,5
	10	–	51
		■	54,5
	25	–	69
		■	72,5
FNC-50	10	–	58
		■	61
	25	–	75,5
		■	79
FNC-63	10	–	61
		■	64
	25	–	78,5
		■	81,5

1) Stroke

2) Position sensing

Ordering data

With female thread – I					
	Piston diameter	Stroke	Corrosion resistance class CRC ¹⁾	Part no.	Type
	6 mm	5 mm	2 - Moderate corrosion stress	4886885	ADN-S-6-5-I
		10 mm		4886886	ADN-S-6-10-I
	10 mm	5 mm		4887523	ADN-S-10-5-I
		10 mm		4887524	ADN-S-10-10-I

1) More information www.festo.com/x/topic/kbk

With female thread – I; with position sensing – A					
	Piston diameter	Stroke	Corrosion resistance class CRC ¹⁾	Part no.	Type
	6 mm	5 mm	1 - Low corrosion stress	5173732	ADN-S-6-5-I-A
		10 mm		5173733	ADN-S-6-10-I-A
	10 mm	5 mm		5177082	ADN-S-10-5-I-A
		10 mm		5177085	ADN-S-10-10-I-A

1) More information www.festo.com/x/topic/kbk

With female thread – I; for battery production – F1A					
	Piston diameter	Stroke	Corrosion resistance class CRC ¹⁾	Part no.	Type
	6 mm	5 mm	2 - Moderate corrosion stress	8142509	ADN-S-6-5-I-F1A
		10 mm		8142510	ADN-S-6-10-I-F1A
	10 mm	5 mm		8142518	ADN-S-10-5-I-F1A
		10 mm		8142519	ADN-S-10-10-I-F1A

1) More information www.festo.com/x/topic/kbk

With female thread – I; with position sensing – A; for battery production – F1A					
	Piston diameter	Stroke	Corrosion resistance class CRC ¹⁾	Part no.	Type
	6 mm	5 mm	2 - Moderate corrosion stress	8142511	ADN-S-6-5-I-A-F1A
		10 mm		8142512	ADN-S-6-10-I-A-F1A
	10 mm	5 mm		8142520	ADN-S-10-5-I-A-F1A
		10 mm		8142521	ADN-S-10-10-I-A-F1A

1) More information www.festo.com/x/topic/kbk

With male thread – A					
	Piston diameter	Stroke	Corrosion resistance class CRC ¹⁾	Part no.	Type
	6 mm	5 mm	2 - Moderate corrosion stress	8080598	ADN-S-6-5-A
		10 mm		8080596	ADN-S-6-10-A
	10 mm	5 mm		8080589	ADN-S-10-5-A
		10 mm		8080588	ADN-S-10-10-A

1) More information www.festo.com/x/topic/kbk

Ordering data

With male thread – A; with position sensing – A

	Piston diameter	Stroke	Corrosion resistance class CRC ¹⁾	Part no.	Type
	6 mm	5 mm	2 - Moderate corrosion stress	8080597	ADN-S-6-5-A-A
		10 mm		8080595	ADN-S-6-10-A-A
	10 mm	5 mm		8080587	ADN-S-10-5-A-A
		10 mm		8080590	ADN-S-10-10-A-A

1) More information www.festo.com/x/topic/kbk

With male thread – A; for battery production – F1A

	Piston diameter	Stroke	Corrosion resistance class CRC ¹⁾	Part no.	Type
	6 mm	5 mm	2 - Moderate corrosion stress	8142513	ADN-S-6-5-A-F1A
		10 mm		8142514	ADN-S-6-10-A-F1A
	10 mm	5 mm		8142522	ADN-S-10-5-A-F1A
		10 mm		8142523	ADN-S-10-10-A-F1A

1) More information www.festo.com/x/topic/kbk

With male thread – A; with position sensing – A; for battery production – F1A

	Piston diameter	Stroke	Corrosion resistance class CRC ¹⁾	Part no.	Type
	6 mm	5 mm	2 - Moderate corrosion stress	8142515	ADN-S-6-5-A-A-F1A
		10 mm		8142516	ADN-S-6-10-A-A-F1A
	10 mm	5 mm		8142517	ADN-S-10-5-A-A-F1A
		10 mm		8142524	ADN-S-10-10-A-A-F1A

1) More information www.festo.com/x/topic/kbk

With cushioning – P; with female thread – I

	Piston diameter	Stroke	Corrosion resistance class CRC ¹⁾	Part no.	Type
	12 mm	5 mm	1 - Low corrosion stress	★ 8076407	ADN-S-12-5-I-P
		10 mm		★ 8076419	ADN-S-12-10-I-P
		15 mm		★ 8076417	ADN-S-12-15-I-P
		20 mm		★ 8076415	ADN-S-12-20-I-P
		25 mm		★ 8076413	ADN-S-12-25-I-P
		30 mm		★ 8076411	ADN-S-12-30-I-P
		35 mm		★ 8076409	ADN-S-12-35-I-P
	16 mm	5 mm		★ 8076393	ADN-S-16-5-I-P
		10 mm		★ 8076405	ADN-S-16-10-I-P
		15 mm		★ 8076403	ADN-S-16-15-I-P
		20 mm		★ 8076401	ADN-S-16-20-I-P
		25 mm		★ 8076399	ADN-S-16-25-I-P
		30 mm		★ 8076397	ADN-S-16-30-I-P
		35 mm		★ 8076395	ADN-S-16-35-I-P
	20 mm	5 mm		★ 8076323	ADN-S-20-5-I-P
		10 mm		★ 8076341	ADN-S-20-10-I-P
		15 mm		★ 8076339	ADN-S-20-15-I-P
		20 mm		★ 8076337	ADN-S-20-20-I-P
		25 mm		★ 8076335	ADN-S-20-25-I-P
		30 mm		★ 8076333	ADN-S-20-30-I-P
		35 mm		★ 8076331	ADN-S-20-35-I-P
		40 mm		★ 8076329	ADN-S-20-40-I-P
		45 mm		★ 8076327	ADN-S-20-45-I-P

Ordering data

With cushioning – P; with female thread – I					
	Piston diameter	Stroke	Corrosion resistance class CRC ¹⁾	Part no.	Type
	20 mm	50 mm	1 - Low corrosion stress	★ 8076325	ADN-S-20-50-I-P
		25 mm		5 mm	★ 8076343
	10 mm			★ 8076361	ADN-S-25-10-I-P
	15 mm			★ 8076359	ADN-S-25-15-I-P
	20 mm			★ 8076357	ADN-S-25-20-I-P
	25 mm			★ 8076355	ADN-S-25-25-I-P
	30 mm			★ 8076353	ADN-S-25-30-I-P
	35 mm			★ 8076351	ADN-S-25-35-I-P
	40 mm			★ 8076349	ADN-S-25-40-I-P
	45 mm			★ 8076347	ADN-S-25-45-I-P
	50 mm			★ 8076345	ADN-S-25-50-I-P
	32 mm			5 mm	★ 8076364
		10 mm		★ 8076382	ADN-S-32-10-I-P
		15 mm		★ 8076380	ADN-S-32-15-I-P
		20 mm		★ 8076378	ADN-S-32-20-I-P
		25 mm		★ 8076376	ADN-S-32-25-I-P
		30 mm		★ 8076374	ADN-S-32-30-I-P
		35 mm		★ 8076372	ADN-S-32-35-I-P
		40 mm		★ 8076370	ADN-S-32-40-I-P
		45 mm		★ 8076368	ADN-S-32-45-I-P
		50 mm		★ 8076366	ADN-S-32-50-I-P

1) More information www.festo.com/x/topic/kbk

With cushioning – P; with female thread – I; with position sensing – A					
	Piston diameter	Stroke	Corrosion resistance class CRC ¹⁾	Part no.	Type
	12 mm	5 mm	1 - Low corrosion stress	★ 8076406	ADN-S-12-5-I-P-A
		10 mm		★ 8076418	ADN-S-12-10-I-P-A
		15 mm		★ 8076416	ADN-S-12-15-I-P-A
		20 mm		★ 8076414	ADN-S-12-20-I-P-A
		25 mm		★ 8076412	ADN-S-12-25-I-P-A
		30 mm		★ 8076410	ADN-S-12-30-I-P-A
		35 mm		★ 8076408	ADN-S-12-35-I-P-A
		16 mm		5 mm	★ 8076392
	10 mm			★ 8076404	ADN-S-16-10-I-P-A
	15 mm			★ 8076402	ADN-S-16-15-I-P-A
	20 mm			★ 8076400	ADN-S-16-20-I-P-A
	25 mm			★ 8076398	ADN-S-16-25-I-P-A
	30 mm			★ 8076396	ADN-S-16-30-I-P-A
	35 mm			★ 8076394	ADN-S-16-35-I-P-A
	20 mm	5 mm		★ 8076322	ADN-S-20-5-I-P-A
		10 mm		★ 8076340	ADN-S-20-10-I-P-A
		15 mm		★ 8076338	ADN-S-20-15-I-P-A
		20 mm		★ 8076336	ADN-S-20-20-I-P-A
		25 mm		★ 8076334	ADN-S-20-25-I-P-A
		30 mm		★ 8076332	ADN-S-20-30-I-P-A
		35 mm		★ 8076330	ADN-S-20-35-I-P-A
		40 mm		★ 8076328	ADN-S-20-40-I-P-A
		45 mm		★ 8076326	ADN-S-20-45-I-P-A
		50 mm		★ 8076324	ADN-S-20-50-I-P-A
		25 mm		5 mm	★ 8076342
	10 mm			★ 8076360	ADN-S-25-10-I-P-A
	15 mm			★ 8076358	ADN-S-25-15-I-P-A
	20 mm			★ 8076356	ADN-S-25-20-I-P-A

Ordering data

With cushioning – P; with female thread – I; with position sensing – A						
	Piston diameter	Stroke	Corrosion resistance class CRC ¹⁾	Part no.	Type	
	25 mm	25 mm	1 - Low corrosion stress	★ 8076354	ADN-S-25-25-I-P-A	
		30 mm		★ 8076352	ADN-S-25-30-I-P-A	
		35 mm		★ 8076350	ADN-S-25-35-I-P-A	
		40 mm		★ 8076348	ADN-S-25-40-I-P-A	
		45 mm		★ 8076346	ADN-S-25-45-I-P-A	
		50 mm		★ 8076344	ADN-S-25-50-I-P-A	
		32 mm		5 mm	★ 8076363	ADN-S-32-5-I-P-A
	10 mm			★ 8076381	ADN-S-32-10-I-P-A	
	15 mm			★ 8076379	ADN-S-32-15-I-P-A	
	20 mm			★ 8076377	ADN-S-32-20-I-P-A	
	25 mm			★ 8076375	ADN-S-32-25-I-P-A	
	30 mm			★ 8076373	ADN-S-32-30-I-P-A	
	35 mm			★ 8076371	ADN-S-32-35-I-P-A	
	40 mm			★ 8076369	ADN-S-32-40-I-P-A	
	45 mm			★ 8076367	ADN-S-32-45-I-P-A	
	50 mm			★ 8076365	ADN-S-32-50-I-P-A	
	40 mm			5 mm	★ 5138606	ADN-S-40-5-I-P-A
				10 mm	★ 5138607	ADN-S-40-10-I-P-A
				15 mm	★ 5138608	ADN-S-40-15-I-P-A
				20 mm	★ 5138609	ADN-S-40-20-I-P-A
		25 mm		★ 5138610	ADN-S-40-25-I-P-A	
		30 mm		★ 5138611	ADN-S-40-30-I-P-A	
		35 mm		★ 5138612	ADN-S-40-35-I-P-A	
		40 mm		★ 5138613	ADN-S-40-40-I-P-A	
		45 mm		★ 5138614	ADN-S-40-45-I-P-A	
		50 mm		★ 5138615	ADN-S-40-50-I-P-A	
		50 mm		5 mm	★ 5138188	ADN-S-50-5-I-P-A
	10 mm			★ 5138189	ADN-S-50-10-I-P-A	
	15 mm			★ 5138190	ADN-S-50-15-I-P-A	
	20 mm			★ 5138191	ADN-S-50-20-I-P-A	
	25 mm			★ 5138192	ADN-S-50-25-I-P-A	
	30 mm			★ 5138193	ADN-S-50-30-I-P-A	
	35 mm			★ 5138194	ADN-S-50-35-I-P-A	
	40 mm			★ 5138195	ADN-S-50-40-I-P-A	
	45 mm			★ 5138196	ADN-S-50-45-I-P-A	
	50 mm			★ 5138197	ADN-S-50-50-I-P-A	
	63 mm			5 mm	★ 5132663	ADN-S-63-5-I-P-A
				10 mm	★ 5132664	ADN-S-63-10-I-P-A
				15 mm	★ 5132665	ADN-S-63-15-I-P-A
		20 mm		★ 5132666	ADN-S-63-20-I-P-A	
		25 mm		★ 5132667	ADN-S-63-25-I-P-A	
		30 mm		★ 5132668	ADN-S-63-30-I-P-A	
		35 mm		★ 5132669	ADN-S-63-35-I-P-A	
		40 mm		★ 5132670	ADN-S-63-40-I-P-A	
		45 mm		★ 5132671	ADN-S-63-45-I-P-A	
		50 mm		★ 5132672	ADN-S-63-50-I-P-A	

1) More information www.festo.com/x/topic/kbk

With cushioning – P; with female thread – I; with position sensing – A; for battery production – F1A					
	Piston diameter	Stroke	Corrosion resistance class CRC ¹⁾	Part no.	Type
	12 mm	5 mm	2 - Moderate corrosion stress	8142562	ADN-S-12-5-I-P-A-F1A

Ordering data

With cushioning – P; with female thread – I; with position sensing – A; for battery production – F1A					
	Piston diameter	Stroke	Corrosion resistance class CRC ¹⁾	Part no.	Type
	12 mm	10 mm	2 - Moderate corrosion stress	8142563	ADN-S-12-10-I-P-A-F1A
		15 mm		8142564	ADN-S-12-15-I-P-A-F1A
		20 mm		8142565	ADN-S-12-20-I-P-A-F1A
		25 mm		8142566	ADN-S-12-25-I-P-A-F1A
		30 mm		8142567	ADN-S-12-30-I-P-A-F1A
		35 mm		8142568	ADN-S-12-35-I-P-A-F1A
	16 mm	5 mm		8142728	ADN-S-16-5-I-P-A-F1A
		10 mm		8142729	ADN-S-16-10-I-P-A-F1A
		15 mm		8142730	ADN-S-16-15-I-P-A-F1A
		20 mm		8142731	ADN-S-16-20-I-P-A-F1A
		25 mm		8142732	ADN-S-16-25-I-P-A-F1A
		30 mm		8142733	ADN-S-16-30-I-P-A-F1A
	20 mm	35 mm		8142734	ADN-S-16-35-I-P-A-F1A
		5 mm		8142756	ADN-S-20-5-I-P-A-F1A
		10 mm		8142757	ADN-S-20-10-I-P-A-F1A
		15 mm		8142758	ADN-S-20-15-I-P-A-F1A
		20 mm		8142759	ADN-S-20-20-I-P-A-F1A
		25 mm		8142760	ADN-S-20-25-I-P-A-F1A
		30 mm		8142761	ADN-S-20-30-I-P-A-F1A
		35 mm		8142762	ADN-S-20-35-I-P-A-F1A
		40 mm		8142763	ADN-S-20-40-I-P-A-F1A
		45 mm		8142764	ADN-S-20-45-I-P-A-F1A
	25 mm	50 mm		8142765	ADN-S-20-50-I-P-A-F1A
		5 mm		8142806	ADN-S-25-5-I-P-A-F1A
		10 mm		8142807	ADN-S-25-10-I-P-A-F1A
		15 mm		8142808	ADN-S-25-15-I-P-A-F1A
		20 mm		8142809	ADN-S-25-20-I-P-A-F1A
		25 mm		8142810	ADN-S-25-25-I-P-A-F1A
		30 mm		8142811	ADN-S-25-30-I-P-A-F1A
		35 mm		8142812	ADN-S-25-35-I-P-A-F1A
		40 mm		8142813	ADN-S-25-40-I-P-A-F1A
		45 mm		8142814	ADN-S-25-45-I-P-A-F1A
	32 mm	50 mm		8142815	ADN-S-25-50-I-P-A-F1A
		5 mm		8142846	ADN-S-32-5-I-P-A-F1A
		10 mm		8142847	ADN-S-32-10-I-P-A-F1A
		15 mm		8142848	ADN-S-32-15-I-P-A-F1A
		20 mm		8142849	ADN-S-32-20-I-P-A-F1A
		25 mm		8142850	ADN-S-32-25-I-P-A-F1A
		30 mm		8142851	ADN-S-32-30-I-P-A-F1A
		35 mm		8142852	ADN-S-32-35-I-P-A-F1A
		40 mm		8142853	ADN-S-32-40-I-P-A-F1A
		45 mm		8142854	ADN-S-32-45-I-P-A-F1A
	40 mm	50 mm		8142855	ADN-S-32-50-I-P-A-F1A
		5 mm		8142876	ADN-S-40-5-I-P-A-F1A
		10 mm		8142877	ADN-S-40-10-I-P-A-F1A
		15 mm		8142878	ADN-S-40-15-I-P-A-F1A
		20 mm		8142879	ADN-S-40-20-I-P-A-F1A
		25 mm		8142880	ADN-S-40-25-I-P-A-F1A
		30 mm		8142881	ADN-S-40-30-I-P-A-F1A
		35 mm		8142882	ADN-S-40-35-I-P-A-F1A
		40 mm		8142883	ADN-S-40-40-I-P-A-F1A
		45 mm		8142884	ADN-S-40-45-I-P-A-F1A
50 mm	50 mm	8142885	ADN-S-40-50-I-P-A-F1A		
	5 mm	8142897	ADN-S-50-5-I-P-A-F1A		

Ordering data

With cushioning – P; with female thread – I; with position sensing – A; for battery production – F1A

	Piston diameter	Stroke	Corrosion resistance class CRC ¹⁾	Part no.	Type
	50 mm	10 mm	2 - Moderate corrosion stress	8142898	ADN-S-50-10-I-P-A-F1A
		15 mm		8142899	ADN-S-50-15-I-P-A-F1A
		20 mm		8142900	ADN-S-50-20-I-P-A-F1A
		25 mm		8142901	ADN-S-50-25-I-P-A-F1A
		30 mm		8142902	ADN-S-50-30-I-P-A-F1A
		35 mm		8142903	ADN-S-50-35-I-P-A-F1A
		40 mm		8142904	ADN-S-50-40-I-P-A-F1A
		45 mm		8142905	ADN-S-50-45-I-P-A-F1A
		50 mm		8142906	ADN-S-50-50-I-P-A-F1A
		63 mm		5 mm	8142917
	10 mm			8142918	ADN-S-63-10-I-P-A-F1A
	15 mm			8142919	ADN-S-63-15-I-P-A-F1A
	20 mm			8142920	ADN-S-63-20-I-P-A-F1A
	25 mm			8142921	ADN-S-63-25-I-P-A-F1A
	30 mm			8142922	ADN-S-63-30-I-P-A-F1A
	35 mm			8142923	ADN-S-63-35-I-P-A-F1A
	40 mm			8142924	ADN-S-63-40-I-P-A-F1A
	45 mm			8142925	ADN-S-63-45-I-P-A-F1A
	50 mm			8142926	ADN-S-63-50-I-P-A-F1A

1) More information www.festo.com/x/topic/kbk

With cushioning – P; with male thread – A

	Piston diameter	Stroke	Corrosion resistance class CRC ¹⁾	Part no.	Type	
	12 mm	5 mm	1 - Low corrosion stress	8091419	ADN-S-12-5-A-P	
		10 mm		8091428	ADN-S-12-10-A-P	
		15 mm		8091416	ADN-S-12-15-A-P	
		20 mm		8091420	ADN-S-12-20-A-P	
		25 mm		8091426	ADN-S-12-25-A-P	
		30 mm		8091423	ADN-S-12-30-A-P	
		35 mm		8091418	ADN-S-12-35-A-P	
		16 mm		5 mm	8091671	ADN-S-16-5-A-P
	10 mm			8091670	ADN-S-16-10-A-P	
	15 mm			8091677	ADN-S-16-15-A-P	
	20 mm			8091666	ADN-S-16-20-A-P	
	25 mm			8091665	ADN-S-16-25-A-P	
	30 mm			8091672	ADN-S-16-30-A-P	
	35 mm			8091676	ADN-S-16-35-A-P	
	20 mm			5 mm	8091431	ADN-S-20-5-A-P
		10 mm		8091449	ADN-S-20-10-A-P	
		15 mm		8091447	ADN-S-20-15-A-P	
		20 mm		8091445	ADN-S-20-20-A-P	
		25 mm		8091443	ADN-S-20-25-A-P	
		30 mm		8091441	ADN-S-20-30-A-P	
		35 mm		8091439	ADN-S-20-35-A-P	
		40 mm		8091437	ADN-S-20-40-A-P	
		45 mm		8091435	ADN-S-20-45-A-P	
		50 mm		8091433	ADN-S-20-50-A-P	
		25 mm		5 mm	8092103	ADN-S-25-5-A-P
				10 mm	8092102	ADN-S-25-10-A-P
	15 mm			8092107	ADN-S-25-15-A-P	
	20 mm			8092091	ADN-S-25-20-A-P	
	25 mm			8092092	ADN-S-25-25-A-P	
	30 mm			8092099	ADN-S-25-30-A-P	

Ordering data

With cushioning – P; with male thread – A					
	Piston diameter	Stroke	Corrosion resistance class CRC ¹⁾	Part no.	Type
	25 mm	35 mm	1 - Low corrosion stress	8092097	ADN-S-25-35-A-P
		40 mm		8092094	ADN-S-25-40-A-P
		45 mm		8092106	ADN-S-25-45-A-P
		50 mm		8092105	ADN-S-25-50-A-P
	32 mm	5 mm		8091452	ADN-S-32-5-A-P
		10 mm		8091461	ADN-S-32-10-A-P
		15 mm		8091460	ADN-S-32-15-A-P
		20 mm		8091453	ADN-S-32-20-A-P
		25 mm		8091467	ADN-S-32-25-A-P
		30 mm		8091465	ADN-S-32-30-A-P
		35 mm		8091456	ADN-S-32-35-A-P
		40 mm		8091450	ADN-S-32-40-A-P
		45 mm		8091451	ADN-S-32-45-A-P
		50 mm		8091462	ADN-S-32-50-A-P

1) More information www.festo.com/x/topic/kbk

With cushioning – P; with male thread – A; with position sensing – A						
	Piston diameter	Stroke	Corrosion resistance class CRC ¹⁾	Part no.	Type	
	12 mm	5 mm	1 - Low corrosion stress	8091427	ADN-S-12-5-A-P-A	
		10 mm		8091424	ADN-S-12-10-A-P-A	
		15 mm		8091422	ADN-S-12-15-A-P-A	
		20 mm		8091429	ADN-S-12-20-A-P-A	
		16 mm		25 mm	8091421	ADN-S-12-25-A-P-A
				30 mm	8091417	ADN-S-12-30-A-P-A
				35 mm	8091425	ADN-S-12-35-A-P-A
				5 mm	8091668	ADN-S-16-5-A-P-A
	10 mm			8091678	ADN-S-16-10-A-P-A	
	15 mm			8091667	ADN-S-16-15-A-P-A	
	20 mm			8091674	ADN-S-16-20-A-P-A	
	20 mm	25 mm		8091675	ADN-S-16-25-A-P-A	
		30 mm		8091669	ADN-S-16-30-A-P-A	
		35 mm		8091673	ADN-S-16-35-A-P-A	
		5 mm		8091430	ADN-S-20-5-A-P-A	
		10 mm		8091448	ADN-S-20-10-A-P-A	
		15 mm		8091446	ADN-S-20-15-A-P-A	
		20 mm		8091444	ADN-S-20-20-A-P-A	
		25 mm		8091442	ADN-S-20-25-A-P-A	
		30 mm		8091440	ADN-S-20-30-A-P-A	
		35 mm		8091438	ADN-S-20-35-A-P-A	
		40 mm		8091436	ADN-S-20-40-A-P-A	
		45 mm		8091434	ADN-S-20-45-A-P-A	
		50 mm		8091432	ADN-S-20-50-A-P-A	
	25 mm	5 mm		8092104	ADN-S-25-5-A-P-A	
		10 mm		8092093	ADN-S-25-10-A-P-A	
		15 mm		8092096	ADN-S-25-15-A-P-A	
		20 mm		8092109	ADN-S-25-20-A-P-A	
		25 mm		8092100	ADN-S-25-25-A-P-A	
		30 mm		8092098	ADN-S-25-30-A-P-A	
		35 mm		8092108	ADN-S-25-35-A-P-A	
		40 mm		8092095	ADN-S-25-40-A-P-A	
		45 mm		8092110	ADN-S-25-45-A-P-A	
		50 mm		8092101	ADN-S-25-50-A-P-A	
		32 mm		5 mm	8091464	ADN-S-32-5-A-P-A

Ordering data

With cushioning – P; with male thread – A; with position sensing – A						
	Piston diameter	Stroke	Corrosion resistance class CRC ¹⁾	Part no.	Type	
	32 mm	10 mm	1 - Low corrosion stress	8091457	ADN-S-32-10-A-P-A	
		15 mm		8091469	ADN-S-32-15-A-P-A	
		20 mm		8091468	ADN-S-32-20-A-P-A	
		25 mm		8091459	ADN-S-32-25-A-P-A	
		30 mm		8091454	ADN-S-32-30-A-P-A	
		35 mm		8091463	ADN-S-32-35-A-P-A	
		40 mm		8091455	ADN-S-32-40-A-P-A	
		45 mm		8091466	ADN-S-32-45-A-P-A	
		50 mm		8091458	ADN-S-32-50-A-P-A	
	40 mm	5 mm		8092050	ADN-S-40-5-A-P-A	
		10 mm		8092067	ADN-S-40-10-A-P-A	
		15 mm		8092053	ADN-S-40-15-A-P-A	
		20 mm		8092064	ADN-S-40-20-A-P-A	
		25 mm		8092056	ADN-S-40-25-A-P-A	
		30 mm		8092061	ADN-S-40-30-A-P-A	
		35 mm		8092051	ADN-S-40-35-A-P-A	
		40 mm		8092059	ADN-S-40-40-A-P-A	
		45 mm		8092065	ADN-S-40-45-A-P-A	
		50 mm		8092054	ADN-S-40-50-A-P-A	
		50 mm		5 mm	8092081	ADN-S-50-5-A-P-A
				10 mm	8092073	ADN-S-50-10-A-P-A
	15 mm			8092085	ADN-S-50-15-A-P-A	
	20 mm			8092076	ADN-S-50-20-A-P-A	
	25 mm			8092075	ADN-S-50-25-A-P-A	
	30 mm			8092074	ADN-S-50-30-A-P-A	
	35 mm			8092071	ADN-S-50-35-A-P-A	
	40 mm			8092087	ADN-S-50-40-A-P-A	
	45 mm			8092079	ADN-S-50-45-A-P-A	
	50 mm			8092086	ADN-S-50-50-A-P-A	
	63 mm			5 mm	8092130	ADN-S-63-5-A-P-A
				10 mm	8092128	ADN-S-63-10-A-P-A
		15 mm		8092135	ADN-S-63-15-A-P-A	
		20 mm		8092120	ADN-S-63-20-A-P-A	
		25 mm		8092121	ADN-S-63-25-A-P-A	
		30 mm		8092125	ADN-S-63-30-A-P-A	
		35 mm		8092133	ADN-S-63-35-A-P-A	
		40 mm		8092134	ADN-S-63-40-A-P-A	
		45 mm		8092138	ADN-S-63-45-A-P-A	
		50 mm		8092119	ADN-S-63-50-A-P-A	

1) More information www.festo.com/x/topic/kbk

With cushioning – P; with male thread – A; with position sensing – A; for battery production – F1A						
	Piston diameter	Stroke	Corrosion resistance class CRC ¹⁾	Part no.	Type	
	12 mm	5 mm	2 - Moderate corrosion stress	8142576	ADN-S-12-5-A-P-A-F1A	
		10 mm		8142577	ADN-S-12-10-A-P-A-F1A	
		15 mm		8142578	ADN-S-12-15-A-P-A-F1A	
		20 mm		8142579	ADN-S-12-20-A-P-A-F1A	
		25 mm		8142580	ADN-S-12-25-A-P-A-F1A	
		30 mm		8142581	ADN-S-12-30-A-P-A-F1A	
		35 mm		8142582	ADN-S-12-35-A-P-A-F1A	
		16 mm		5 mm	8142735	ADN-S-16-5-A-P-A-F1A
				10 mm	8142736	ADN-S-16-10-A-P-A-F1A
	15 mm			8142737	ADN-S-16-15-A-P-A-F1A	

Ordering data

With cushioning – P; with male thread – A; with position sensing – A; for battery production – F1A					
	Piston diameter	Stroke	Corrosion resistance class CRC ¹⁾	Part no.	Type
	16 mm	20 mm	2 - Moderate corrosion stress	8142738	ADN-S-16-20-A-P-A-F1A
		25 mm		8142739	ADN-S-16-25-A-P-A-F1A
		30 mm		8142740	ADN-S-16-30-A-P-A-F1A
		35 mm		8142741	ADN-S-16-35-A-P-A-F1A
		20 mm		5 mm	8142766
	10 mm			8142767	ADN-S-20-10-A-P-A-F1A
	15 mm			8142768	ADN-S-20-15-A-P-A-F1A
	20 mm			8142769	ADN-S-20-20-A-P-A-F1A
	25 mm			8142770	ADN-S-20-25-A-P-A-F1A
	30 mm			8142771	ADN-S-20-30-A-P-A-F1A
	35 mm			8142772	ADN-S-20-35-A-P-A-F1A
	40 mm			8142773	ADN-S-20-40-A-P-A-F1A
	45 mm			8142774	ADN-S-20-45-A-P-A-F1A
	50 mm			8142775	ADN-S-20-50-A-P-A-F1A
	25 mm	5 mm		8142826	ADN-S-25-5-A-P-A-F1A
		10 mm	8142827	ADN-S-25-10-A-P-A-F1A	
		15 mm	8142828	ADN-S-25-15-A-P-A-F1A	
		20 mm	8142829	ADN-S-25-20-A-P-A-F1A	
		25 mm	8142830	ADN-S-25-25-A-P-A-F1A	
		30 mm	8142831	ADN-S-25-30-A-P-A-F1A	
		35 mm	8142832	ADN-S-25-35-A-P-A-F1A	
		40 mm	8142833	ADN-S-25-40-A-P-A-F1A	
		45 mm	8142834	ADN-S-25-45-A-P-A-F1A	
		50 mm	8142835	ADN-S-25-50-A-P-A-F1A	
	32 mm	5 mm	0 - No corrosion stress	8142866	ADN-S-32-5-A-P-A-F1A
		10 mm		8142867	ADN-S-32-10-A-P-A-F1A
		15 mm		8142868	ADN-S-32-15-A-P-A-F1A
		20 mm		8142869	ADN-S-32-20-A-P-A-F1A
		25 mm		8142870	ADN-S-32-25-A-P-A-F1A
		30 mm		8142871	ADN-S-32-30-A-P-A-F1A
		35 mm		8142872	ADN-S-32-35-A-P-A-F1A
		40 mm		8142873	ADN-S-32-40-A-P-A-F1A
		45 mm		8142874	ADN-S-32-45-A-P-A-F1A
		50 mm		8142875	ADN-S-32-50-A-P-A-F1A
	40 mm	5 mm		8142886	ADN-S-40-5-A-P-A-F1A
		10 mm		8142887	ADN-S-40-10-A-P-A-F1A
		15 mm		8142888	ADN-S-40-15-A-P-A-F1A
		20 mm		8142889	ADN-S-40-20-A-P-A-F1A
		25 mm		8142890	ADN-S-40-25-A-P-A-F1A
		30 mm	8142891	ADN-S-40-30-A-P-A-F1A	
		35 mm	8142892	ADN-S-40-35-A-P-A-F1A	
		40 mm	8142893	ADN-S-40-40-A-P-A-F1A	
		45 mm	8142894	ADN-S-40-45-A-P-A-F1A	
		50 mm	8142895	ADN-S-40-50-A-P-A-F1A	
	50 mm	5 mm	8142907	ADN-S-50-5-A-P-A-F1A	
		10 mm	8142908	ADN-S-50-10-A-P-A-F1A	
		15 mm	8142909	ADN-S-50-15-A-P-A-F1A	
		20 mm	8142910	ADN-S-50-20-A-P-A-F1A	
		25 mm	8142911	ADN-S-50-25-A-P-A-F1A	
		30 mm	8142912	ADN-S-50-30-A-P-A-F1A	
		35 mm	8142913	ADN-S-50-35-A-P-A-F1A	
		40 mm	8142914	ADN-S-50-40-A-P-A-F1A	
45 mm		8142915	ADN-S-50-45-A-P-A-F1A		
50 mm		8142916	ADN-S-50-50-A-P-A-F1A		
63 mm	5 mm		8142927	ADN-S-63-5-A-P-A-F1A	

Ordering data

With cushioning – P; with male thread – A; with position sensing – A; for battery production – F1A					
	Piston diameter	Stroke	Corrosion resistance class CRC ¹⁾	Part no.	Type
	63 mm	10 mm	0 - No corrosion stress	8142928	ADN-S-63-10-A-P-A-F1A
		15 mm		8142929	ADN-S-63-15-A-P-A-F1A
		20 mm		8142930	ADN-S-63-20-A-P-A-F1A
		25 mm		8142931	ADN-S-63-25-A-P-A-F1A
		30 mm		8142932	ADN-S-63-30-A-P-A-F1A
		35 mm		8142933	ADN-S-63-35-A-P-A-F1A
		40 mm		8142934	ADN-S-63-40-A-P-A-F1A
		45 mm		8142935	ADN-S-63-45-A-P-A-F1A
		50 mm		8142936	ADN-S-63-50-A-P-A-F1A

1) More information www.festo.com/x/topic/kbk

Peripherals

Peripherals overview

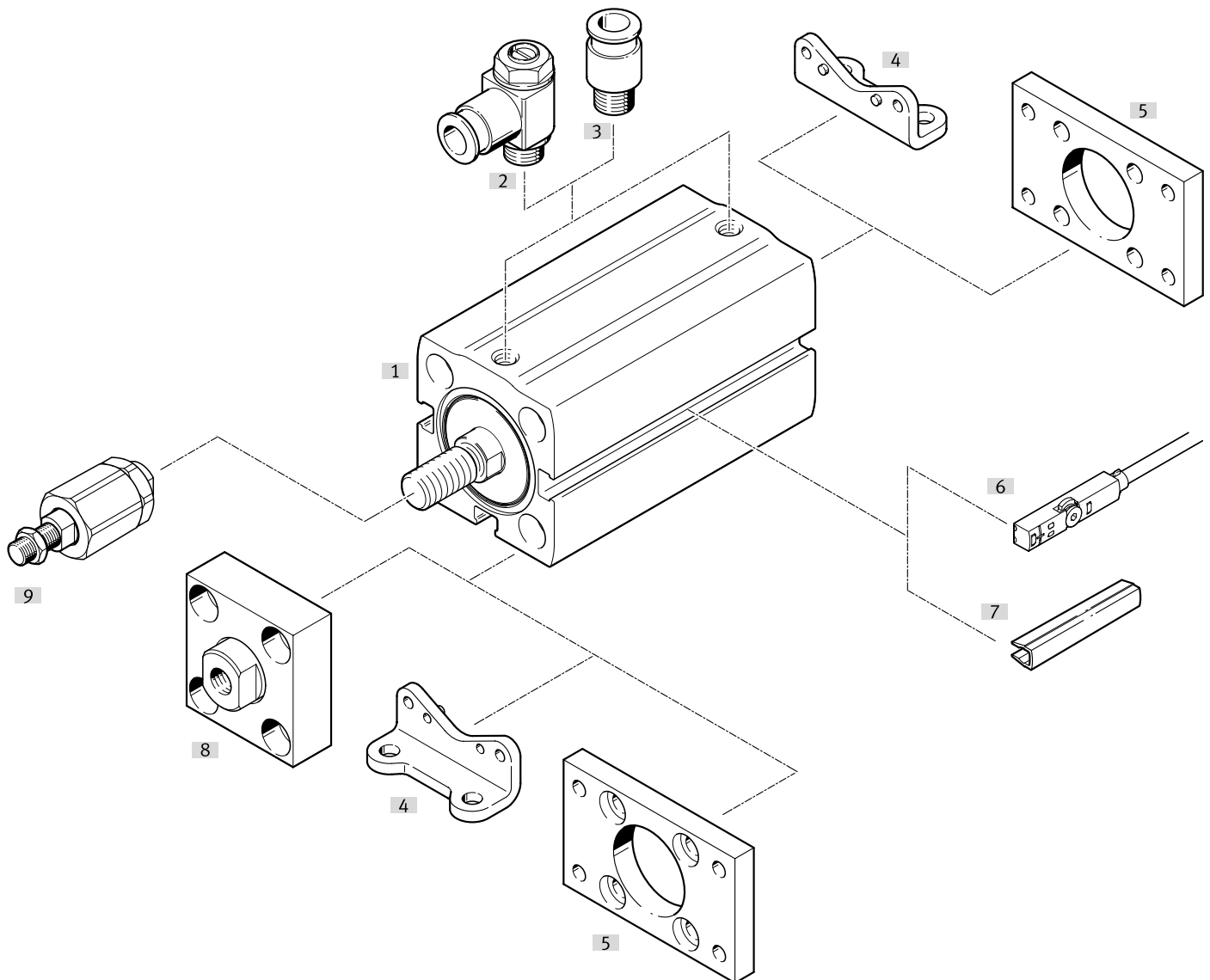

Accessories			→ Page/Internet
Type/order code		Description	
[1]	Compact cylinder ADN-S	Double-acting	adn-s
[2]	One-way flow control valve GRLA	For \varnothing 12 ... 63: for regulating speed	29
[2]	One-way flow control valve GRLZ	For \varnothing 12 ... 63: for regulating speed	29
[3]	Push-in fitting QS	For \varnothing 12 ... 63: For connecting tubing with standard O.D.	qs
[4]	Foot mounting HNA	For \varnothing 12 ... 63: for bearing or end caps	
[5]	Flange mounting FNC	For \varnothing 12 ... 63: for bearing or end caps	28
[6]	Proximity switch SMT-10	For \varnothing 6 ... 10: can be integrated in the cylinder profile barrel	29
[6]	Proximity switch SMT-8	For \varnothing 12 ... 63: can be integrated in the cylinder profile barrel	30
[6]	Position transmitter SDAS-MHS	For \varnothing 12 ... 63: can be integrated in the cylinder profile barrel	30
[6]	Position transmitter SDAT-MHS	For \varnothing 12 ... 63: can be integrated in the cylinder profile barrel	30
[6]	Position transmitter SMAT-8	For \varnothing 12 ... 63: can be integrated in the cylinder profile barrel	31
[7]	Slot cover ABP	For \varnothing 12 ... 63: to protect the sensor cables and the sensor slots from contamination	31
[8]	Coupling piece KSG	For \varnothing 32 ... 63: to compensate for radial deviations	28
[8]	Coupling piece KSZ	For \varnothing 32 ... 63: to compensate for radial deviations	28
[9]	Self-aligning rod coupler FK/DARP	For \varnothing 12 ... 63: To compensate for radial and angular deviations	28

Accessories

Self-aligning rod coupler FK

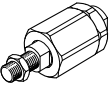
	Description	Material housing	Suitability for the production of Li-ion batteries ¹⁾	Product weight	Part no.	Type
	For Ø 12	Steel, Galvanised	F1	20 g	30984	FK-M5
	For Ø 16			23 g	★ 2061	FK-M6
	For Ø 20, 25			50 g	★ 2062	FK-M8
	For Ø 32, 40			210 g	★ 6140	FK-M10X1,25
	For Ø 50, 63			215 g	★ 6141	FK-M12X1,25

1) More information www.festo.com/x/topic/bat

Self-aligning rod coupler DARP

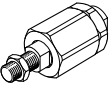
	Description	Material housing	Suitability for the production of Li-ion batteries ¹⁾	Product weight	Part no.	Type
	For Ø 12	High-alloy stainless steel	F5a	24 g	8170112	DARP-M5-F
	For Ø 16			25 g	8170115	DARP-M6-F
	For Ø 20, 25			58 g	8170116	DARP-M8-F
	For Ø 32, 40			236 g	8170119	DARP-M10P-F
	For Ø 50, 63			244 g	8170120	DARP-M12P-F

1) More information www.festo.com/x/topic/bat

Coupling piece KSG

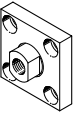
	Description	Material mounting	Suitability for the production of Li-ion batteries ¹⁾	Product weight	Part no.	Type
	For Ø 32, 40	Steel, Galvanised	F1	229 g	32963	KSG-M10X1,25
	For Ø 50, 63			447 g	32964	KSG-M12X1,25

1) More information www.festo.com/x/topic/bat

Coupling piece KSZ

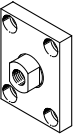
	Description	Material mounting	Suitability for the production of Li-ion batteries ¹⁾	Product weight	Part no.	Type
	For Ø 32, 40	Steel, Galvanised	F1	110 g	36125	KSZ-M10X1,25
	For Ø 50, 63			180 g	36126	KSZ-M12X1,25

1) More information www.festo.com/x/topic/bat

Flange mounting FNC

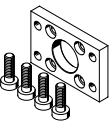
	Description	Material mounting	Product weight	Part no.	Type
	For Ø 12	Steel, Galvanised	79 g	537245	FNC-12
	For Ø 16		88 g	537246	FNC-16
	For Ø 20		141 g	537247	FNC-20
	For Ø 25		165 g	537248	FNC-25
	For Ø 32		221 g	174376	FNC-32
	For Ø 40		291 g	174377	FNC-40
	For Ø 50		536 g	174378	FNC-50
	For Ø 63		679 g	174379	FNC-63

Accessories

One-way flow control valves GRLA – for exhaust air

	Description	Pneumatic connection 1	Pneumatic connection, port 2	Part no.	Type	
	For Ø 6, 10	Push-in connector 3 mm	M3	175041	GRLA-M3-QS-3	
	For Ø 12, 16, 20, 25, 32, 40		Push-in connector 4 mm	M5	★ 193137	GRLA-M5-QS-3-D
					★ 193138	GRLA-M5-QS-4-D
		Push-in connector 6 mm		★ 193139	GRLA-M5-QS-6-D	
	For Ø 50, 63	Push-in connector 3 mm	G1/8		193142	GRLA-1/8-QS-3-D
		Push-in connector 4 mm		★ 193143	GRLA-1/8-QS-4-D	
		Push-in connector 6 mm		★ 193144	GRLA-1/8-QS-6-D	
		Push-in connector 8 mm		★ 193145	GRLA-1/8-QS-8-D	

One-way flow control valves GRLZ – for supply air

	Description	Pneumatic connection 1	Pneumatic connection, port 2	Part no.	Type	
	For Ø 6, 10	Push-in connector 3 mm	M3	175043	GRLZ-M3-QS-3	
	For Ø 12, 16, 20, 25, 32, 40		Push-in connector 4 mm	M5	★ 193153	GRLZ-M5-QS-3-D
					★ 193154	GRLZ-M5-QS-4-D
		Push-in connector 6 mm		★ 193155	GRLZ-M5-QS-6-D	
	For Ø 50, 63	Push-in connector 3 mm	G1/8		193156	GRLZ-1/8-QS-3-D
		Push-in connector 4 mm		★ 193157	GRLZ-1/8-QS-4-D	
		Push-in connector 6 mm		★ 193158	GRLZ-1/8-QS-6-D	
		Push-in connector 8 mm		★ 193159	GRLZ-1/8-QS-8-D	

Proximity switch SMT-10 for round slot, magneto-resistive – for Ø 6 ... 10

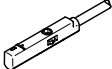
	Type of mounting	Switching output	Electrical connection	Cable length	Part no.	Type
	Screw-clamped, insertable in the slot from above	3-wire NPN N/O contact	Open end	2.5 m	★ 551377	SMT-10M-NS-24V-E-2,5-L-OE
			Plug M8, A-coded	0.3 m	★ 551379	SMT-10M-NS-24V-E-0,3-L-M8D
		3-wire PNP N/O contact	Open end	2.5 m	★ 551373	SMT-10M-PS-24V-E-2,5-L-OE
			Plug M8, A-coded	0.3 m	★ 551375	SMT-10M-PS-24V-E-0,3-L-M8D

Connecting cables NEBU, straight

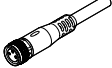
	Electrical connection 1, connector system	Electrical connection 2, connector system	Electrical connection 2, number of connections/cores	Cable length	Part no.	Type
	M8x1, A-coded, to EN 61076-2-104	Open end	3	2.5 m	★ 541333	NEBU-M8G3-K-2.5-LE3
				5 m	★ 541334	NEBU-M8G3-K-5-LE3

Accessories

Connecting cables NEBU, angled

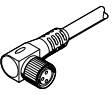
	Electrical connection 1, connector system	Electrical connection 2, connector system	Electrical connection 2, number of connections/cores	Cable length	Part no.	Type
	M8x1, A-coded, to EN 61076-2-104	Open end	3	2.5 m	★ 541338	NEBU-M8W3-K-2.5-LE3
				5 m	★ 541341	NEBU-M8W3-K-5-LE3

Proximity switch SMT-8 for T-slot, magneto-resistive – for Ø 12 ... 63

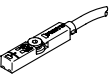
	Type of mounting	Switching output	Electrical connection	Cable length	Part no.	Type
	Screw-clamped, Insertable in the slot from above	3-wire NPN N/O contact	Open end	2.5 m	★ 574338	SMT-8M-A-NS-24V-E-2,5-OE
			Plug M8, A-coded	0.3 m	★ 574339	SMT-8M-A-NS-24V-E-0,3-M8D
		3-wire PNP N/C contact	Open end	7.5 m	★ 574340	SMT-8M-A-PO-24V-E-7,5-OE
			3-wire PNP N/O contact	2.5 m	★ 574335	SMT-8M-A-PS-24V-E-2,5-OE
		Plug M8, A-coded	0.3 m	★ 574334	SMT-8M-A-PS-24V-E-0,3-M8D	

Connecting cables NEBU, straight

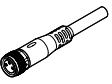
	Electrical connection 1, connector system	Electrical connection 2, connector system	Electrical connection 2, number of connections/cores	Cable length	Part no.	Type
	M8x1, A-coded, to EN 61076-2-104	Open end	3	2.5 m	★ 541333	NEBU-M8G3-K-2.5-LE3
				5 m	★ 541334	NEBU-M8G3-K-5-LE3

Connecting cables NEBU, angled

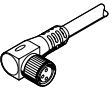
	Electrical connection 1, connector system	Electrical connection 2, connector system	Electrical connection 2, number of connections/cores	Cable length	Part no.	Type
	M8x1, A-coded, to EN 61076-2-104	Open end	3	2.5 m	★ 541338	NEBU-M8W3-K-2.5-LE3
				5 m	★ 541341	NEBU-M8W3-K-5-LE3

Position transmitter SDAS for T-slot, plug M8, A-coded – for Ø 12 ... 63

	Description	Sensing range	Electrical connection 1, number of connections/cores	Cable length	Part no.	Type
	Operating modes: two adjustable switching outputs; IO-Link®	52 mm	4	0.3 m	8063974	SDAS-MHS-M40-1L-PNLK-PN-E-0.3-M8
				2.5 m	8063975	SDAS-MHS-M40-1L-PNLK-PN-E-2.5-LE

Position transmitter SDAT for T-slot, plug M8, A-coded – for Ø 12 ... 63

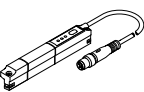
	Sensing range	Analogue output	Electrical connection 1, number of connections/cores	Cable length	Part no.	Type
	0 ... 50.000 mm	4 · 20 mA	4	0.3 m	1531265	SDAT-MHS-M50-1L-SA-E-0.3-M8

Accessories

Position transmitter SMAT for T-slot, plug M8, A-coded – for Ø 12 ... 63

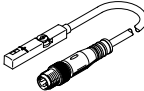
	Sensing range	Analogue output	Electrical connection 1, number of connections/ cores	Cable length	Part no.	Type
	52 mm	0 - 10 V	4	0.3 m	553744	SMAT-8M-U-E-0,3-M8D

Connecting cables NEBU, straight

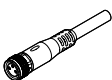
	Electrical connection 1, connector system	Electrical connection 2, connector system	Electrical connection 2, number of connections/ cores	Cable length	Part no.	Type
	M8x1, A-coded, to EN 61076-2-104	Open end	4	2.5 m	541342	NEBU-M8G4-K-2.5-LE4
				5 m	541343	NEBU-M8G4-K-5-LE4

Connecting cables NEBU, angled

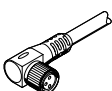
	Electrical connection 1, connector system	Electrical connection 2, connector system	Electrical connection 2, number of connections/ cores	Cable length	Part no.	Type
	M8x1, A-coded, to EN 61076-2-104	Open end	4	2.5 m	541344	NEBU-M8W4-K-2.5-LE4
				5 m	541345	NEBU-M8W4-K-5-LE4

Slot cover ABP for T-slot – for Ø 12 ... 63

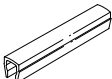
	Description	Material housing	Packaging quantity [pieces]	Part no.	Type
	Length 0.5 m, Inserted from above	ABS	2	151680	ABP-5-S