

## Proportional directional control valves VPWS

**FESTO**



## Key features

### General

The solenoid valves VPWS are proportional directional control valves. This means that the flow rate of suitable media can be controlled proportionally. Approved operating media include air, oxygen and inert gases.

The solenoid valve VPWS should only be operated within the limits defined in the technical data. The specific on-site operating conditions are to be observed.

### Overview of valve with manifold block

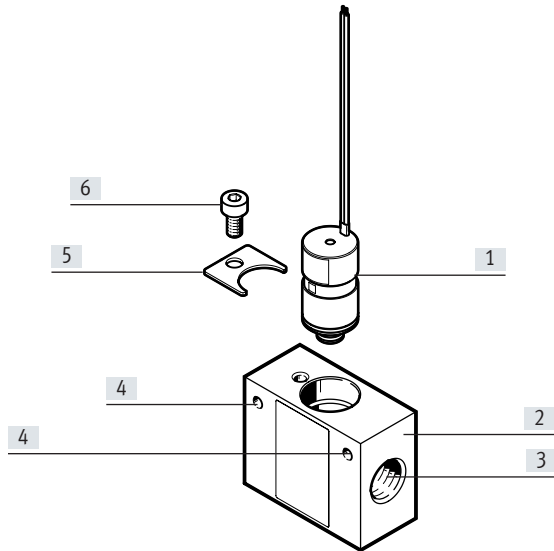

- [1] Solenoid valve VPWS
- [2] Manifold block
- [3] Pneumatic connection
- [4] Mounting hole for M3 screws
- [5] Mounting
- [6] Socket head screw M4

### Note

The product has no redundancy and no error detection. When malfunctions need to be detected, this must be done by implementing the necessary measures in the customer product.

## Type codes

<b>001</b>	<b>Series</b>	
<b>VPWS</b>	Proportional directional control valve	

<b>002</b>	<b>Nominal width [mm]</b>	
<b>0.3</b>	0.3	
<b>1</b>	1	
<b>1.5</b>	1.5	
<b>2.2</b>	2.2	
<b>6</b>	6	

<b>003</b>	<b>Directional control valve type</b>	
<b>B</b>	Sub-base valve	



<b>004</b>	<b>Valve function</b>	
<b>6</b>	2/2-way valve, normally closed	

<b>005</b>	<b>Pneumatic connection</b>	
<b>PC15</b>	Cartridge 15 mm	
<b>PC8</b>	Cartridge 8 mm	

<b>006</b>	<b>Pressure range [bar]</b>	
<b>3</b>	0 ... 3	
<b>7</b>	0 ... 7	
<b>8</b>	0 ... 8	
<b>10</b>	0 ... 10	

<b>007</b>	<b>Sealant</b>	
<b>V</b>	FPM	

## Technical data

-  Flow rate  
46 ... 220 l/min
-  Diameter of cartridge  
7.5 ... 15 mm
-  Voltage  
≤19 ... 19.9 V DC

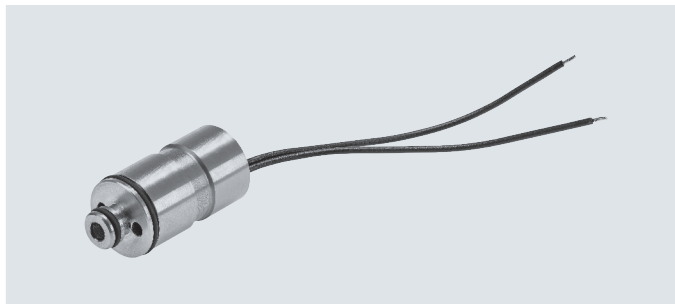
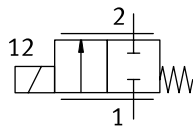
**General technical data**

Nominal width DN		0.3 mm	1 mm	1.5 mm	2.2 mm	6 mm
Valve function		2/2-way proportional directional control valve, closed				
Reset method		Mechanical spring				
Design		Directly actuated poppet valve				
Sealing principle		Soft				
Actuation type		Electrical				
Type of control		Direct				
Direction of flow		Not reversible				
Mounting position		Any				
Type of mounting		On sub-base Plug-in With accessories				
Pneumatic connection 1		Cartridge 8 mm	Cartridge 15 mm			Cartridge 7.5 mm
Pneumatic connection 2		Cartridge 5.8 mm	Cartridge 7.2 mm			Cartridge 15 mm
Flow rate q	VPWS-... [l/min]	6.6 ... 8	68 ... 88	82 ... 98	46 ... 56	200 ... 220
	VPWS-6-B-6-PC15-7-V [l/min]	-				
Product weight	[g]	5	23	25		
Degree of protection to EN 60529		IP60				
Note on degree of protection		IP65 with suitable plug In assembled state				

**Operating and environmental conditions**

Nominal width DN		0.3 mm	1 mm	1.5 mm	2.2 mm	6 mm	
Medium		Inert gases Air Oxygen					
Note on the medium		Lubricated operation not possible					
Note on the medium, maximum particle size	[µm]	10					
Operating pressure	VPWS-... [MPa]	0 ... 1	0 ... 1	0 ... 0.8	0 ... 0.3		
		[bar]	0 ... 10	0 ... 10	0 ... 8	0 ... 3	
	VPWS-6-B-6-PC15-7-V [MPa]	-	-	-	-	0 ... 0.7	
		[bar]	-	-	-	-	0 ... 7
Nominal operating pressure	VPWS-... [MPa]	1	1	0 ... 0.8	0.3	0.2	
		[bar]	10	10	8	3	2
		[psi]	145	145	116	43.5	29
	VPWS-6-B-6-PC15-7-V [MPa]	-	-	-	-	0 ... 0.7	
		[bar]	-	-	-	-	0 ... 7
		[psi]	-	-	-	-	101.5
Ambient temperature	[°C]	+5 ... +50					
Temperature of medium	[°C]	+5 ... +50					
Storage temperature	[°C]	-40 ... +80					
Corrosion resistance class CRC <sup>1)</sup>		1					

 1) More information: [www.festo.com/x/topic/kbk](http://www.festo.com/x/topic/kbk)

## Technical data

<b>Electrical data</b>		0.3 mm	1 mm	1.5 mm	2.2 mm
Nominal width DN					
Continuous operating voltage at 20°C without inflow	[V DC]	–	≤ 16.5		
Continuous operating voltage at 50°C without inflow	[V DC]	–	≤ 14.5		
Typical continuous operating voltage at 50 °C with inflow	[V DC]	–	≤ 19.0		
Max. switching frequency	[Hz]	25	18		
Hysteresis	[mA]	14	16		
Coil resistance	[Ω]	308	60.5		
Max. electrical power consumption	[W]	1.5	2.5		
Current regulating range	[mA]	0 ... 70	0 ... 200		
Duty cycle ED	[%]	100 (see assembly instructions)			

Nominal width DN		6 mm	
		Air	Oxygen
Continuous operating voltage at 20°C without inflow	[V DC]	≤ 14.5	≤ 11.4
Continuous operating voltage at 50°C without inflow	[V DC]	≤ 13.3	≤ 9.6
Typical continuous operating voltage at 50°C with inflow (≥ 30 l/min)	[V DC]	≤ 19.9	
Switching time on	[ms]	10	
Hysteresis	[mA]	22.5	
Coil resistance	[Ω]	60.5	
Max. electrical power consumption	[W]	3	
Current regulating range	[mA]	0 ... 225	
Duty cycle ED	[%]	100 (see assembly instructions)	

<b>Electrical connection</b>		
Electrical connection	Connection technology	Open end
	Number of pins/wires	2
	Connection type	Cable
Cable length	[mm]	70 ... 80

<b>Materials</b>	
Housing	High-alloy steel
Seals	FPM
Note on materials	RoHS-compliant
PWIS conformity	VDMA24364 zone III

## Technical data

### Flow rate/current characteristic curves

Nominal width 0.3 mm

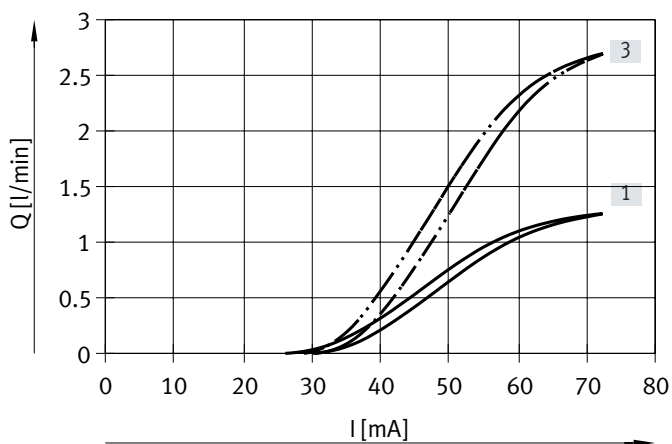

[1] Characteristic curve for 1 bar

[3] Characteristic curve for 3 bar

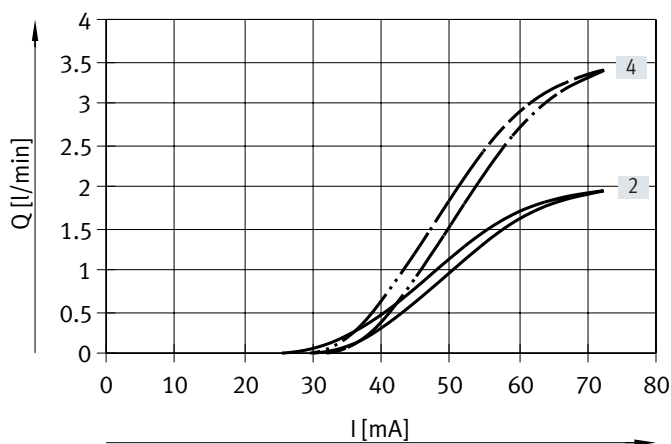

[2] Characteristic curve for 2 bar

[4] Characteristic curve for 4 bar

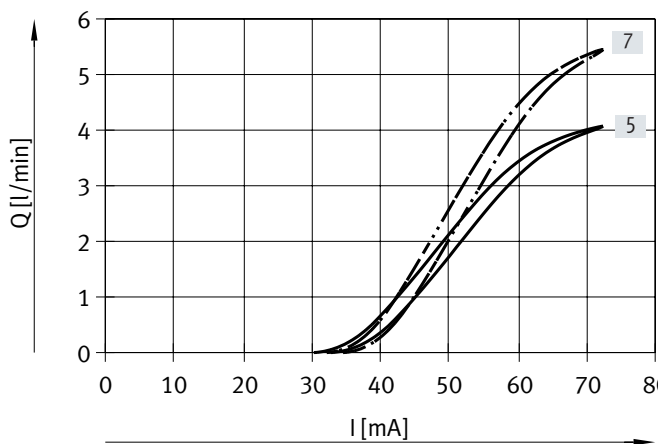

[5] Characteristic curve for 5 bar

[7] Characteristic curve for 7 bar

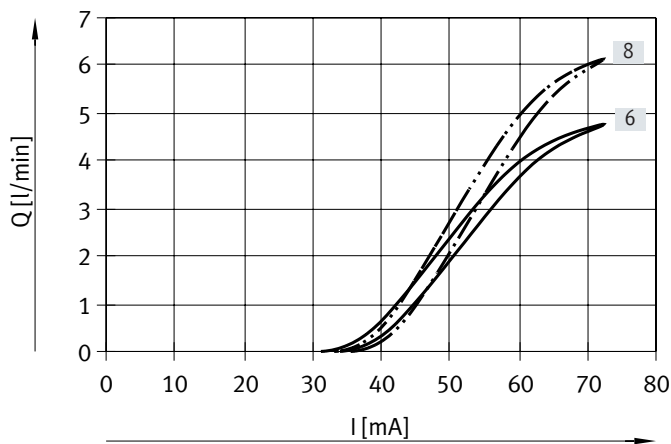

[6] Characteristic curve for 6 bar

[8] Characteristic curve for 8 bar

## Technical data

## Flow rate/current characteristic curves

Nominal width 0.3 mm

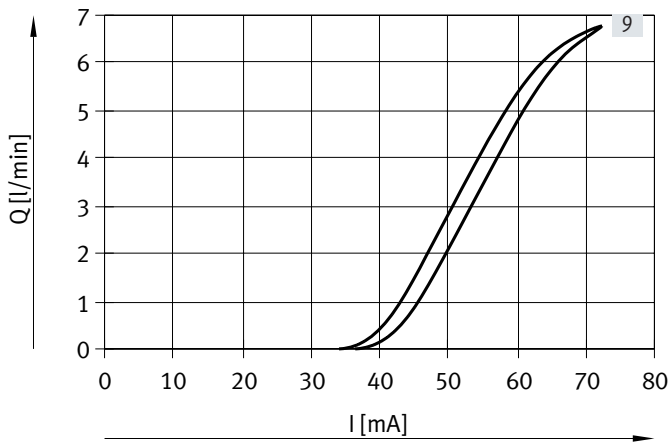

[9] Characteristic curve for 9 bar

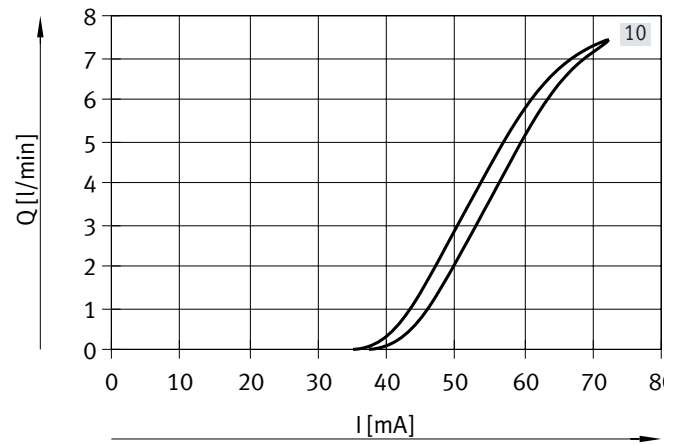

[10] Characteristic curve for 10 bar

**Note**

Resonance may occur during operation at a low frequency and this may affect the flow rate. Operation at very low flow rates may generate noise. No resonance occurs during operation at a frequency of 0.3 Hz or higher.

## Technical data

### Flow rate/current characteristic curves

Nominal width 1 mm

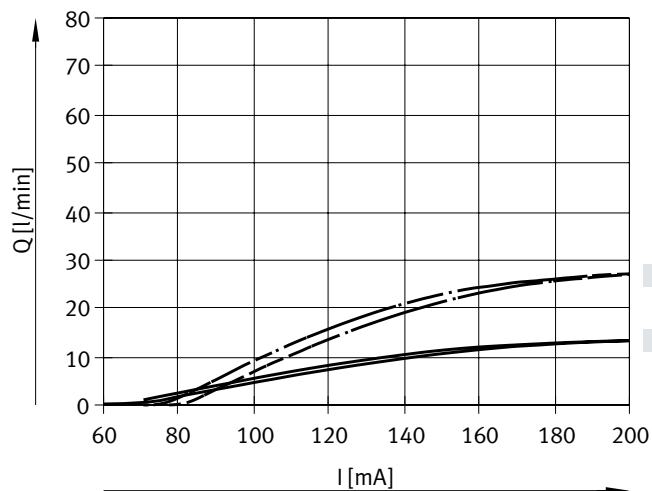

[1] Characteristic curve for 1 bar

[3] Characteristic curve for 3 bar

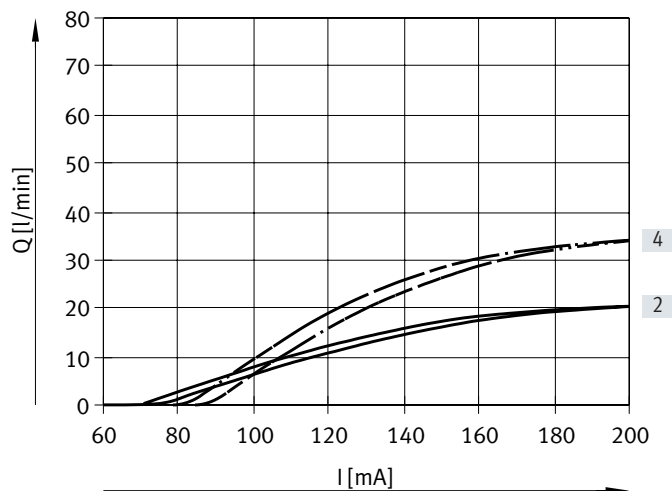

[2] Characteristic curve for 2 bar

[4] Characteristic curve for 4 bar

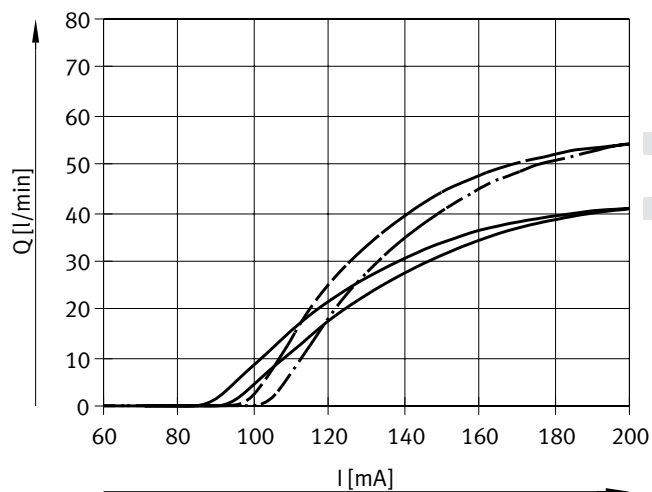

[5] Characteristic curve for 5 bar

[7] Characteristic curve for 7 bar

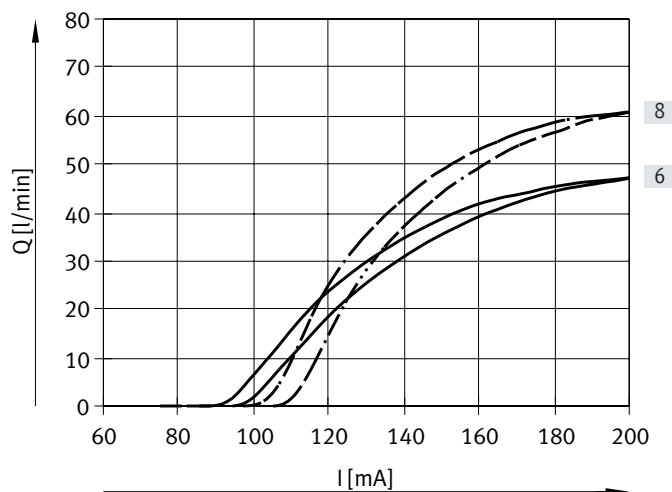

[6] Characteristic curve for 6 bar

[8] Characteristic curve for 8 bar



## Technical data

## Flow rate/current characteristic curves

Nominal width 1 mm

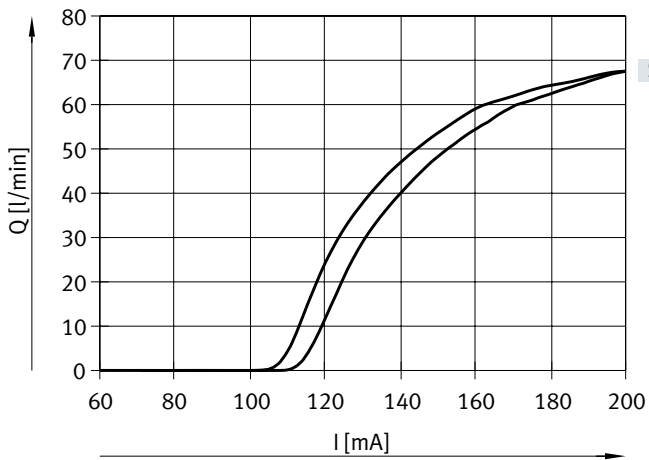

[9] Characteristic curve for 9 bar

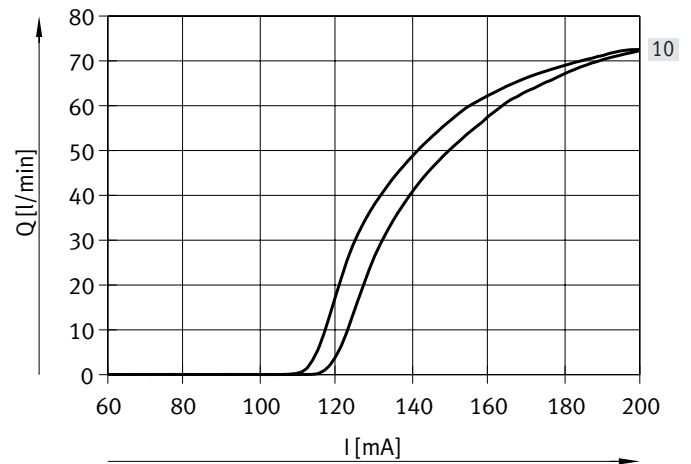

[10] Characteristic curve for 10 bar

**Note**

Resonance may occur during operation at a low frequency and this may affect the flow rate. Operation at very low flow rates may generate noise. No resonance occurs during operation at a frequency of 0.3 Hz or higher.

## Technical data

### Flow rate/current characteristic curves

Nominal width 1.5 mm

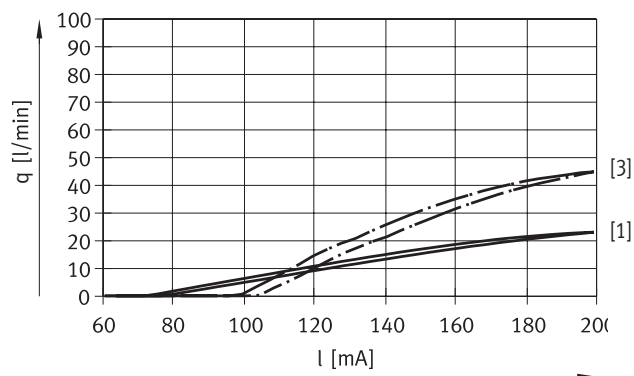

[1] Characteristic curve for 1 bar

[3] Characteristic curve for 3 bar

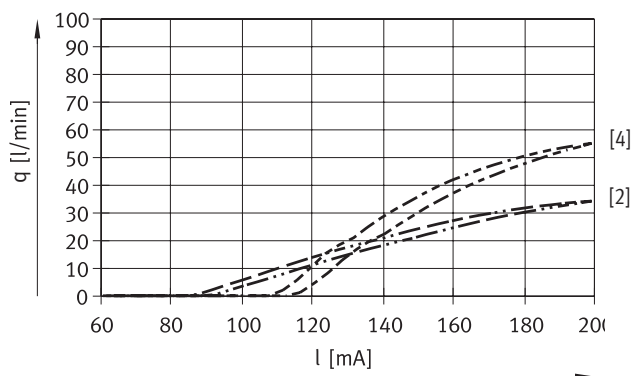

[2] Characteristic curve for 2 bar

[4] Characteristic curve for 4 bar

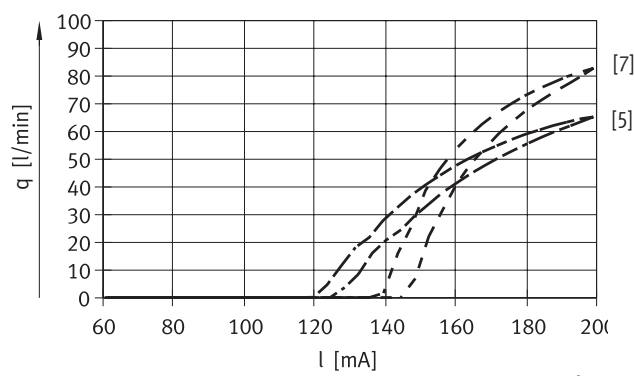

[5] Characteristic curve for 5 bar

[7] Characteristic curve for 7 bar

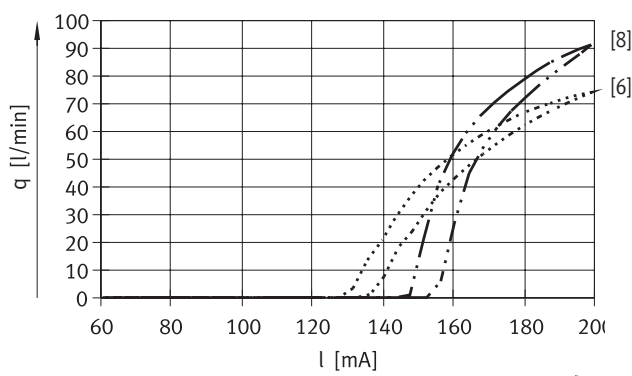

[6] Characteristic curve for 6 bar

[8] Characteristic curve for 8 bar

#### Note

Resonance may occur during operation at a low frequency and this may affect the flow rate. Operation at very low flow rates may generate noise. No resonance occurs during operation at a frequency of 0.3 Hz or higher.

## Technical data

### Flow rate/current characteristic curves

Nominal width 2.2 mm

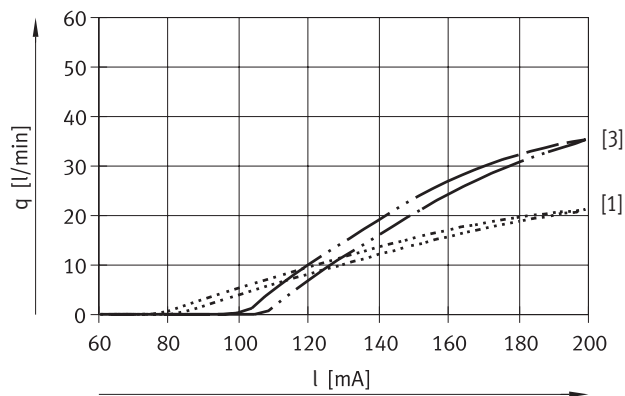

[1] Characteristic curve for 0.5 bar

[3] Characteristic curve for 1.5 bar

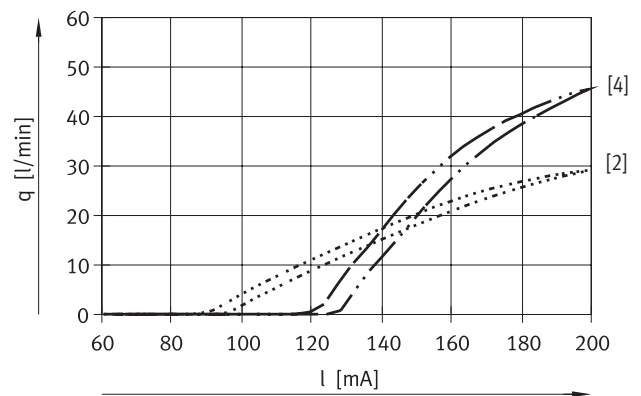

[2] Characteristic curve for 1.0 bar

[4] Characteristic curve for 2.5 bar

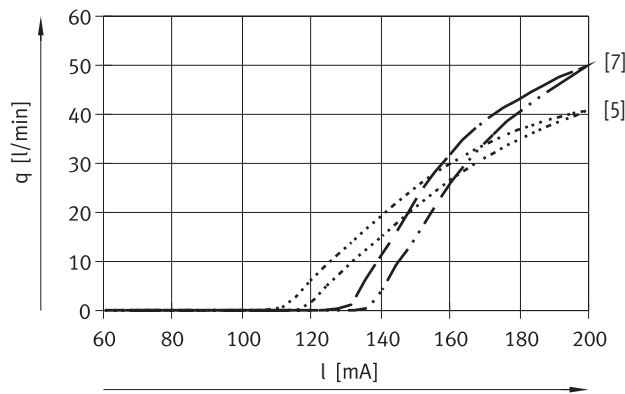

[5] Characteristic curve for 2.0 bar

[7] Characteristic curve for 3.0 bar

### Flow rate/pressure characteristic curve at 200 mA

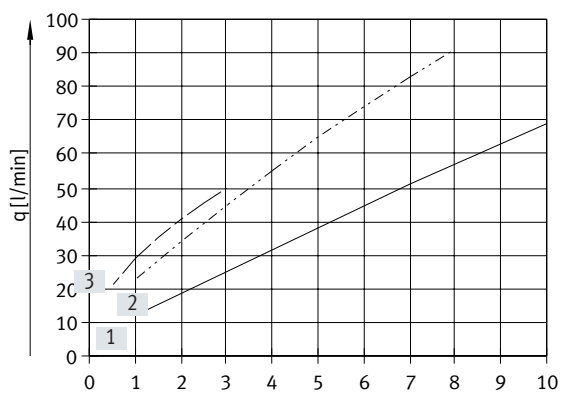

- [1] VPWS-DN 1
- [2] VPWS-DN 1.5
- [3] VPWS-DN 2.2

## Technical data

### Flow rate/current characteristic curves

Nominal width 6 mm. VPWS-6-B-6-PC15-3-V

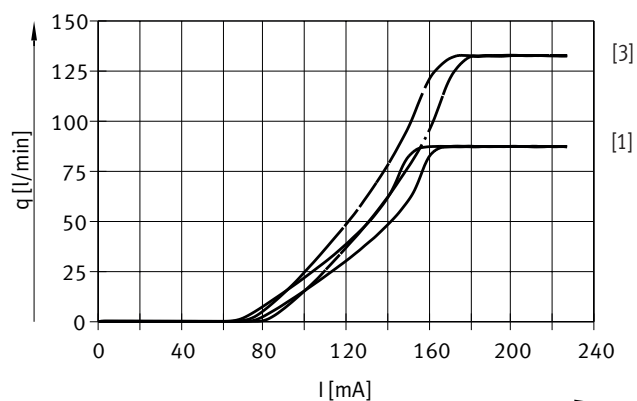

[1] Characteristic curve for 0.5 bar [3] Characteristic curve for 1 bar

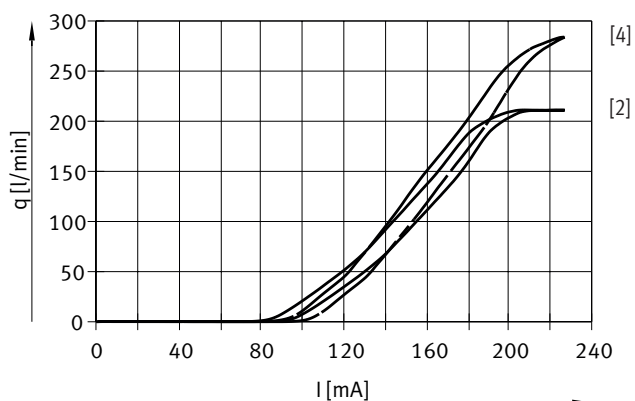

[2] Characteristic curve for 2 bar [4] Characteristic curve for 3 bar

Nominal width 6 mm. VPWS-6-B-6-PC15-7-V

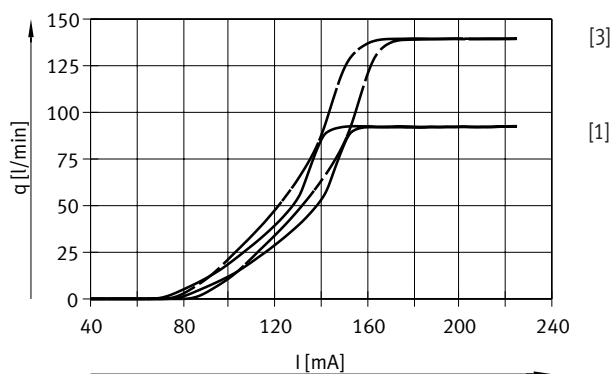

[1] Characteristic curve for 0.5 bar [3] Characteristic curve for 1 bar

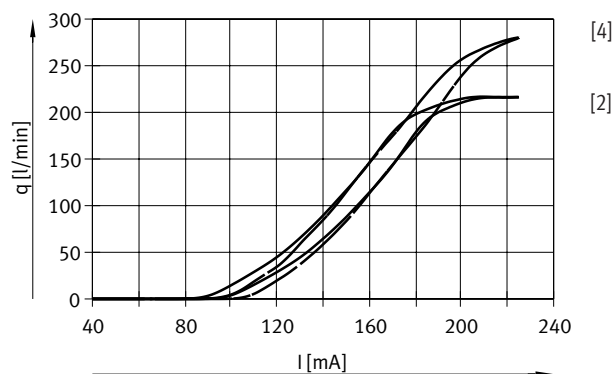

[2] Characteristic curve for 2 bar [4] Characteristic curve for 3 bar

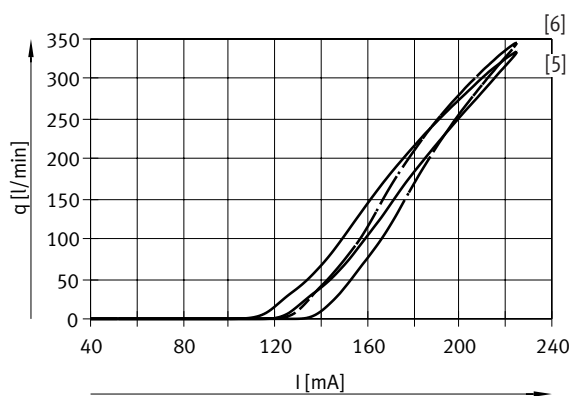

[5] Characteristic curve for 5 bar [6] Characteristic curve for 7 bar

## Technical data

## Flow rate/pressure characteristic curve at 225 mA

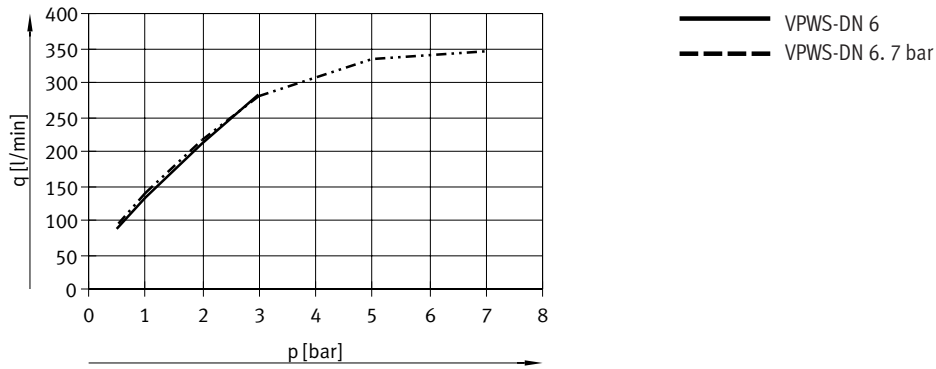

## Technical data

### Dimensions

Download CAD data → [www.festo.com](http://www.festo.com)

Proportional directional control valve

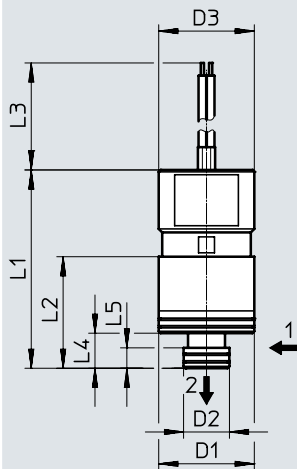

[1] Pneumatic connection 1  
(with VPWS-6 as connection 2)

[2] Pneumatic connection 2  
(with VPWS-6 as connection 1)

Type	D1 ø	D2 ø	D3 ø	L1	L2	L3	L4	L5
VPWS-0.3-B-6-PC8-10-V	8	5.8	8	24.3	11.5	70 ... 80	4.5	2.6
VPWS-1-B-6-PC15-10-V	15	7.2	15	31	17.5	70 ... 80	5.5	3.2
VPWS-1.5-B-6-PC15-8-V	15	7.2	15	31	17.5	70 ... 80	5.5	3.2
VPWS-2.2-B-6-PC15-3-V	15	7.2	15	31	17.5	70 ... 80	5.5	3.2
VPWS-6-B-6-PC15-3-V	15	7.5	15	36.4	22.9	70 ... 80	7.23	2.9
VPWS-6-B-6-PC15-7-V	15	7.5	15	36.4	22.9	70 ... 80	7.23	2.9

### Dimensions

Download CAD data → [www.festo.com](http://www.festo.com)

Manifold block

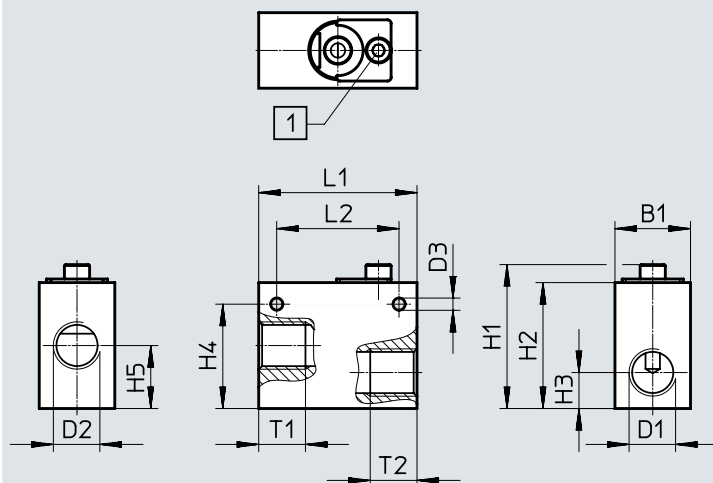

[1] Socket head screw M4X8

Type	B1	D1	D2	D3 ø	H1	H2	H3	H4	H5	L1	L2	T1	T2
VABS-P4-8S-G18	12	M5	M5	3.5	22.4	19	4.6	-	9.9	-	-	5	5
VABS-P4-10S-G14	21	G1/4	G1/4	3.4	40	35	10	29	17.5	44	34	13	13
VABS-P4-20S-G38	25	G3/8	G3/8	3.4	47	42	11.5	36	19	44	34	13	13

## Technical data

## Dimensions

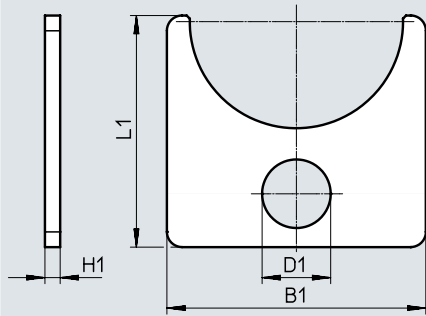

Download CAD data → [www.festo.com](http://www.festo.com)

## Mounting

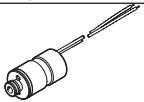
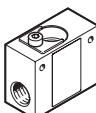

Type	B1	D1	H1	L1
VAME-P4-PC8-P-P10	9	3.6	0.5	10.9
VAME-P4-PC15-P-P10	17	4.5	1	15.2

## Ordering data

		Part No.	Type	PU <sup>1)</sup>	
<b>Proportional directional control valve</b>					
	2/2-way proportional directional control valve, closed	Nominal width 0.3 mm	<b>8186784</b>	<b>VPWS-0.3-B-6-PC8-10-V</b>	1
		Nominal width 1 mm	<b>8186783</b>	<b>VPWS-1-B-6-PC15-10-V</b>	1
		Nominal width 1.5 mm	<b>8074075</b>	<b>VPWS-1.5-B-6-PC15-8-V</b>	1
		Nominal width 2.2 mm	<b>8074074</b>	<b>VPWS-2.2-B-6-PC15-3-V</b>	1
		Nominal width 6 mm	<b>8074537</b>	<b>VPWS-6-B-6-PC15-3-V</b>	1
		Nominal width 6 mm	<b>8074538</b>	<b>VPWS-6-B-6-PC15-7-V</b>	1
<b>Manifold block</b>					
	Suitable for proportional directional control valves with nominal width 0.3 mm Set for 2/2-way proportional directional control valve VPWS, comprising:	<b>8186785</b>	<b>VABS-P4-8S-G18</b>	1	
	<ul style="list-style-type: none"> <li>Manifold block VABS-P4-8S-G18</li> <li>1 mounting component from the set VAME-P4-PC15-P-P10</li> <li>Socket head screw M4x8</li> </ul>				
	Suitable for proportional directional control valves with nominal width 1.5 and 2.2 mm Set for 2/2-way proportional directional control valve VPWS, comprising:				
<ul style="list-style-type: none"> <li>Manifold block VABS-P4-10S-G14</li> <li>1 mounting component from the set VAME-P4-PC15-P-P10</li> <li>Socket head screw M4x8</li> </ul>	<b>8087327</b>	<b>VABS-P4-10S-G14</b>	1		
Suitable for proportional directional control valve with nominal width 6 mm Set for 2/2-way proportional directional control valve VPWS, comprising:	<b>8087328</b>	<b>VABS-P4-20S-G38</b>	1		
<ul style="list-style-type: none"> <li>Manifold block VABS-P4-20S-G38</li> <li>1 mounting component from the set VAME-P4-PC15-P-P10</li> <li>Socket head screw M4x8</li> </ul>					
<b>Mounting</b>					
	For 2/2-way proportional directional control valve VPWS in manifold block VABS (set comprises 10 mountings for 10 proportional directional control valves VPWS)	<b>8187513</b>	<b>VAME-P4-PC8-P-P10</b>	10	
		<b>8087347</b>	<b>VAME-P4-PC15-P-P10</b>	1	

1) Packaging unit.