

- 1 - Tip, ki se opušča  
Dobavljiv do 2008

## Standardni valji DNU/DNUL, DIN ISO 6431

FESTO

Za nove konstrukcije uporabljati  
standardni valj DNC

→ 1 / 1.2-24

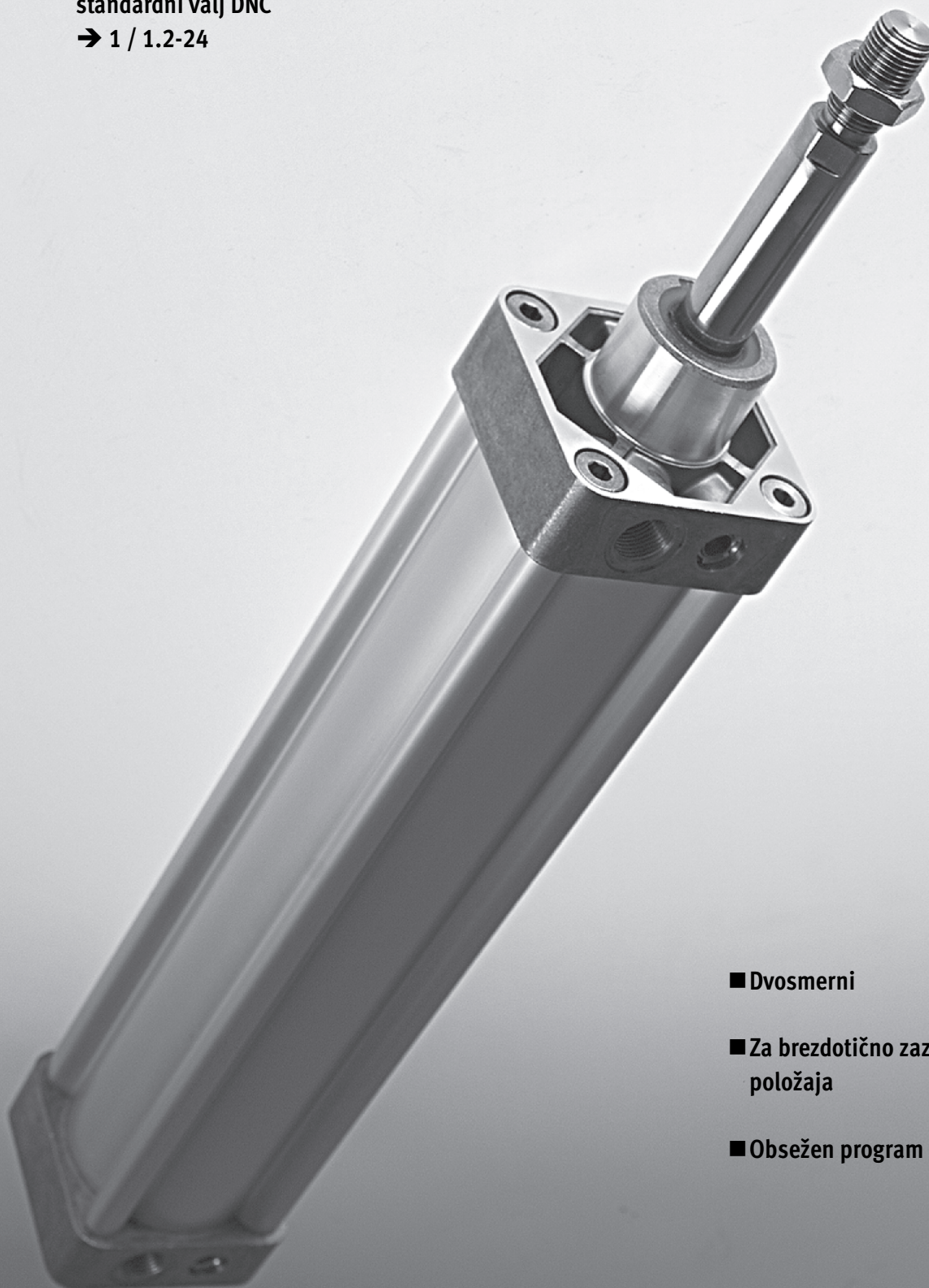

- Dvosmerni
- Za brezdotično zaznavanje položaja
- Obsežen program pribora

Valji na osnovi standardov  
DIN ISO 6431

1.3

## Standardni valji DNU/DNUL, DIN ISO 6431

Pregled dobav

FESTO

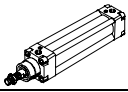
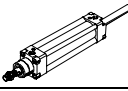
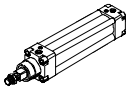
Funkcija	Izvedba	Tip	Ø bata [mm]	Gib [mm]	Zaznavanje položaja A	Dušenje nastavljivo PPV	
dvosmerni	<b>Osnovni tip</b>						
		<b>DNU</b> enostranski Batnica	32, 40, 50, 63, 80, 100	25, 40, 50, 80, 100, 125, 160, 200, 250, 300, 320, 400, 500	10 ... 2000	■	■
		<b>DNU-...-S2</b> skožnja Batnica	32, 40, 50, 63, 80, 100	-	10 ... 2000	■	■
	<b>batnica varovana pred zasukom</b>						
		<b>DNUL</b> enostranska batnica	32 40 50, 63 80, 100	- - - -	10 ... 300 10 ... 400 10 ... 500 10 ... 600	■	■

## Standardni valji DNU/DNUL, DIN ISO 6431

Pregled dobav

Tip	Batnica Nerjavno jeklo S3	Toplotno obstojno tesnilo do maks. 150 °C S6	visoka zaščita pred korozijo S8
<b>Osnovni tip</b>			
<b>DNU</b> enostranski Batnica	■	■	■
<b>DNU-...-S2</b> skozijska Batnica	-	■	-
<b>batnica varovana pred zasukom</b>			
<b>DNUL</b> enostranski Batnica	-	■	-

## Standardni valji DNU/DNUL, DIN ISO 6431

Podatkovni list

FESTO

Podatki za naročanje							
Izvedba	Gib [mm]	Ø bata 32 [mm]		Ø bata 40 [mm]		Ø bata 50 [mm]	
		Št. dela	Tip <sup>1)</sup>	Št. dela	Tip <sup>1)</sup>	Št. dela	Tip <sup>1)</sup>
<b>Osnovni tip</b>							
	25	14 121	DNU-32-25-PPV-A	14 132	DNU-40-25-PPV-A	14 143	DNU-50-25-PPV-A
	40	14 122	DNU-32-40-PPV-A	14 133	DNU-40-40-PPV-A	14 144	DNU-50-40-PPV-A
	50	14 123	DNU-32-50-PPV-A	14 134	DNU-40-50-PPV-A	14 145	DNU-50-50-PPV-A
	80	14 124	DNU-32-80-PPV-A	14 135	DNU-40-80-PPV-A	14 146	DNU-50-80-PPV-A
	100	14 125	DNU-32-100-PPV-A	14 136	DNU-40-100-PPV-A	14 147	DNU-50-100-PPV-A
	125	14 126	DNU-32-125-PPV-A	14 137	DNU-40-125-PPV-A	14 148	DNU-50-125-PPV-A
	160	14 127	DNU-32-160-PPV-A	14 138	DNU-40-160-PPV-A	14 149	DNU-50-160-PPV-A
	200	14 128	DNU-32-200-PPV-A	14 139	DNU-40-200-PPV-A	14 150	DNU-50-200-PPV-A
	250	14 129	DNU-32-250-PPV-A	14 140	DNU-40-250-PPV-A	14 151	DNU-50-250-PPV-A
	300	14 130	DNU-32-300-PPV-A	14 141	DNU-40-300-PPV-A	14 152	DNU-50-300-PPV-A
	320	34 704	DNU-32-320-PPV-A	34 705	DNU-40-320-PPV-A	34 706	DNU-50-320-PPV-A
	400	32 473	DNU-32-400-PPV-A	32 475	DNU-40-400-PPV-A	32 477	DNU-50-400-PPV-A
	500	32 474	DNU-32-500-PPV-A	32 476	DNU-40-500-PPV-A	32 478	DNU-50-500-PPV-A
Spremenljiv gib	10 ... 2 000	14 120	DNU-32-...-PPV-A	14 131	DNU-40-...-PPV-A	14 142	DNU-50-...-PPV-A
Varianta S2	10 ... 2 000	14 186	DNU-32-...-PPV-A-S2	14 187	DNU-40-...-PPV-A-S2	14 188	DNU-50-...-PPV-A-S2
Varianta S3	10 ... 2 000	158 844	DNU-32-...-PPV-A-S3	158 845	DNU-40-...-PPV-A-S3	158 846	DNU-50-...-PPV-A-S3
Varianta S6	10 ... 2 000	14 919	DNU-32-...-PPV-A-S6	14 920	DNU-40-...-PPV-A-S6	14 921	DNU-50-...-PPV-A-S6
Varianta S8	10 ... 2 000	158 850	DNU-32-...-PPV-A-S8	158 851	DNU-40-...-PPV-A-S8	158 852	DNU-50-...-PPV-A-S8
Varianta S26	10 ... 2 000	14 925	DNU-32-...-PPV-A-S26	14 926	DNU-40-...-PPV-A-S26	14 927	DNU-50-...-PPV-A-S26
<b>z batnico varovano pred zasukom</b>							
Spremenljiv gib	10 ... 300	15 602	DNUL-32-...-PPV-A	-	-	-	-
	10 ... 400	-	-	15 603	DNUL-40-...-PPV-A	-	-
	10 ... 500	-	-	-	-	15 604	DNUL-50-...-PPV-A
	10 ... 600	-	-	-	-	-	-
Varianta S6	10 ... 300	15 660	DNUL-32-...-PPV-A-S6	-	-	-	-
	10 ... 400	-	-	15 661	DNUL-40-...-PPV-A-S6	-	-
	10 ... 500	-	-	-	-	15 662	DNUL-50-...-PPV-A-S6
	10 ... 600	-	-	-	-	-	-

1) V obseg dobave je vključena šestroba matica za navoj na batnici.

## Standardni valji DNU/DNUL, DIN ISO 6431

Podatkovni list

FESTO

Podatki za naročanje							
Izvedba	Gib [mm]	Ø bata 63 [mm]		Ø bata 80 [mm]		Ø bata 100 [mm]	
		Št. dela	Tip <sup>1)</sup>	Št. dela	Tip <sup>1)</sup>	Št. dela	Tip <sup>1)</sup>
<b>Osnovni tip</b>							
	25	14 154	DNU-63-25-PPV-A	14 165	DNU-80-25-PPV-A	14 176	DNU-100-25-PPV-A
	40	14 155	DNU-63-40-PPV-A	14 166	DNU-80-40-PPV-A	14 177	DNU-100-40-PPV-A
	50	14 156	DNU-63-50-PPV-A	14 167	DNU-80-50-PPV-A	14 178	DNU-100-50-PPV-A
	80	14 157	DNU-63-80-PPV-A	14 168	DNU-80-80-PPV-A	14 179	DNU-100-80-PPV-A
	100	14 158	DNU-63-100-PPV-A	14 169	DNU-80-100-PPV-A	14 180	DNU-100-100-PPV-A
	125	14 159	DNU-63-125-PPV-A	14 170	DNU-80-125-PPV-A	14 181	DNU-100-125-PPV-A
	160	14 160	DNU-63-160-PPV-A	14 171	DNU-80-160-PPV-A	14 182	DNU-100-160-PPV-A
	200	14 161	DNU-63-200-PPV-A	14 172	DNU-80-200-PPV-A	14 183	DNU-100-200-PPV-A
	250	14 162	DNU-63-250-PPV-A	14 173	DNU-80-250-PPV-A	14 184	DNU-100-250-PPV-A
	300	14 163	DNU-63-300-PPV-A	14 174	DNU-80-300-PPV-A	14 185	DNU-100-300-PPV-A
	320	34 707	DNU-63-320-PPV-A	34 708	DNU-80-320-PPV-A	34 709	DNU-100-320-PPV-A
	400	32 479	DNU-63-400-PPV-A	32 481	DNU-80-400-PPV-A	32 483	DNU-100-400-PPV-A
500	32 480	DNU-63-500-PPV-A	32 482	DNU-80-500-PPV-A	32 484	DNU-100-500-PPV-A	
Spremenljiv gib	10 ... 2 000	14 153	DNU-63-...-PPV-A	14 164	DNU-80-...-PPV-A	14 175	DNU-100-...-PPV-A
Varianta S2	10 ... 2 000	14 189	DNU-63-...-PPV-A-S2	14 190	DNU-80-...-PPV-A-S2	14 191	DNU-100-...-PPV-A-S2
Varianta S3	10 ... 2 000	158 847	DNU-63-...-PPV-A-S3	158 848	DNU-80-...-PPV-A-S3	158 849	DNU-100-...-PPV-A-S3
Varianta S6	10 ... 2 000	14 922	DNU-63-...-PPV-A-S6	14 923	DNU-80-...-PPV-A-S6	14 924	DNU-100-...-PPV-A-S6
Varianta S8	10 ... 2 000	158 853	DNU-63-...-PPV-A-S8	158 854	DNU-80-...-PPV-A-S8	158 855	DNU-100-...-PPV-A-S8
Varianta S26	10 ... 2 000	14 928	DNU-63-...-PPV-A-S26	14 929	DNU-80-...-PPV-A-S26	14 930	DNU-100-...-PPV-A-S26
<b>z batnico varovano pred zasukom</b>							
Spremenljiv gib	10 ... 300	-		-		-	
	10 ... 400	-		-		-	
	10 ... 500	15 605	DNUL-63-...-PPV-A				
	10 ... 600	-		15 606	DNUL-80-...-PPV-A	15 607	DNUL-100-...-PPV-A
Varianta S6	10 ... 300	-		-		-	
	10 ... 400	-		-		-	
	10 ... 500	15 663	DNUL-63-...-PPV-A-S6	-		-	
	10 ... 600	-		15 664	DNUL-80-...-PPV-A-S6	15 665	DNUL-100-...-PPV-A-S6

1) V obseg dobave je vključena šestroba matica za navoj na batnici.



## Standardni valji DNU/DNUL, DIN ISO 6431

Pribor

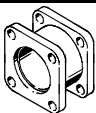
FESTO

Podatki za naročanje – večpoložajni sklop DPNN				
	za Ø	Material	Št. dela	Tip
	32	Prilobnica: Al zlitina za kovanje;	<b>13 468</b>	<b>DPNN-32</b>
	40	Navojni zatiči, šestrobe matice: jeklo, cinkano	<b>13 469</b>	<b>DPNN-40</b>
	50	Brez bakra, PTFE in silikonov	<b>13 470</b>	<b>DPNN-50</b>
	63		<b>13 471</b>	<b>DPNN-63</b>
	80		<b>13 472</b>	<b>DPNN-80</b>
	100		<b>13 473</b>	<b>DPNN-100</b>

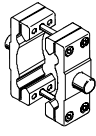
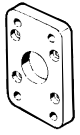
 Opozorilo  
Pri kombinaciji valjev in večpoložajnih sklopov se ne sme preseči maksimalne celotne dolžine giba.



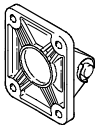
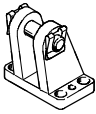

Podatki za naročanje					Podatki za naročanje				
Naziv	za Ø	Št. dela	Tip		Naziv	za Ø	Št. dela	Tip	
<b>Pritrditev s kotnikom HN</b>					<b>Sklop nihajnih tečajev ZNU</b>				
32		<b>5 135</b>	<b>HN-32</b>			32		<b>14 210</b>	<b>ZNU-32</b>
40		<b>5 136</b>	<b>HN-40</b>			40		<b>14 211</b>	<b>ZNU-40</b>
50		<b>5 137</b>	<b>HN-50</b>			50		<b>14 212</b>	<b>ZNU-50</b>
63		<b>5 138</b>	<b>HN-63</b>			63		<b>14 213</b>	<b>ZNU-63</b>
80		<b>5 139</b>	<b>HN-80</b>			80		<b>14 214</b>	<b>ZNU-80</b>
100		<b>5 140</b>	<b>HN-100</b>	100			<b>14 215</b>	<b>ZNU-100</b>	
<b>Prirobnična pritrnitev FN</b>					<b>Ležajni element LNZ</b>				
32		<b>5 141</b>	<b>FN-32</b>			32		<b>6 184</b>	<b>LNZ-32</b>
40		<b>5 142</b>	<b>FN-40</b>			40/50		<b>6 185</b>	<b>LNZ-40/50</b>
50		<b>5 143</b>	<b>FN-50</b>			63/80		<b>6 186</b>	<b>LNZ-63/80</b>
63		<b>5 144</b>	<b>FN-63</b>			100		<b>6 187</b>	<b>LNZ-100/125</b>
80		<b>5 145</b>	<b>FN-80</b>						
100		<b>5 146</b>	<b>FN-100</b>						

Podatki za naročanje – nihajna prirobica					Podatki za naročanje – nihajna prirobica				
Naziv	za Ø	Št. dela	Tip		Naziv	za Ø	Št. dela	Tip	
<b>Nihajna prirobica SN</b>					<b>Nihajna prirobica SSN za ležajni podstavek LBG s sferičnim uležajanjem</b>				
32		<b>5 153</b>	<b>SN-32</b>			32		<b>34 285</b>	<b>SSN-32</b>
40		<b>5 154</b>	<b>SN-40</b>			40		<b>34 286</b>	<b>SSN-40</b>
50		<b>5 155</b>	<b>SN-50</b>			50		<b>34 287</b>	<b>SSN-50</b>
63		<b>5 156</b>	<b>SN-63</b>			63		<b>34 288</b>	<b>SSN-63</b>
80		<b>5 157</b>	<b>SN-80</b>			80		<b>34 289</b>	<b>SSN-80</b>
100		<b>5 158</b>	<b>SN-100</b>	100			<b>34 290</b>	<b>SSN-100</b>	

# Standardni valji DNU/DNUL, DIN ISO 6431

Pribor

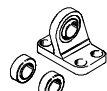
FESTO

Podatki za naročanje – pritrdilni elementi				Podatkovni listi → 1 / 10.1-2			
Naziv	za Ø	Št. dela	Tip	Naziv	za Ø	Št. dela	Tip
<b>Ležajni blok LN</b>				<b>Ležajni blok LNG</b>			
	32	5 147	LN-32		32	33 890	LNG-32
	40	5 148	LN-40		40	33 891	LNG-40
	50	5 149	LN-50		50	33 892	LNG-50
	63	5 150	LN-63		63	33 893	LNG-63
	80	5 151	LN-80		80	33 894	LNG-80
	100	5 152	LN-100		100	33 895	LNG-100
<b>Ležajni blok LSN</b>				<b>Ležajni blok LBG</b>			
	32	5 561	LSN-32		32	31 761	LBG-32
	40	5 562	LSN-40		40	31 762	LBG-40
	50	5 563	LSN-50		63	31 764	LBG-63
	63	5 564	LSN-63		100	31 766	LBG-100
	80	5 565	LSN-80				
	100	5 566	LSN-100				





Podatki za naročanje – povratno-dušilni ventili				Podatkovni listi → Zvezek 2	
	Priključek		Material	Št. dela	Tip
	Navoj	za zunanji Ø cevi			
	G $\frac{1}{8}$	3	kovinska izvedba	193 142	GRLA- $\frac{1}{8}$ -QS-3-D
		4		193 143	GRLA- $\frac{1}{8}$ -QS-4-D
		6		193 144	GRLA- $\frac{1}{8}$ -QS-6-D
		8		193 145	GRLA- $\frac{1}{8}$ -QS-8-D
	G $\frac{1}{4}$	6		193 146	GRLA- $\frac{1}{4}$ -QS-6-D
		8		193 147	GRLA- $\frac{1}{4}$ -QS-8-D
		10		193 148	GRLA- $\frac{1}{4}$ -QS-10-D
	G $\frac{3}{8}$	6		193 149	GRLA- $\frac{3}{8}$ -QS-6-D
		8		193 150	GRLA- $\frac{3}{8}$ -QS-8-D
		10		193 151	GRLA- $\frac{3}{8}$ -QS-10-D
	G $\frac{1}{2}$	12		193 152	GRLA- $\frac{1}{2}$ -QS-12-D

 Osnovni program izdelkov

## Standardni valji DNU/DNUL, DIN ISO 6431

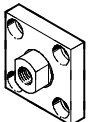
Pribor

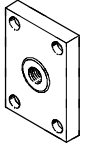
FESTO

Podatki za naročanje – priključni deli za batnico				Podatkovni listi → 1 / 10.3-2			
Naziv	za Ø	Št. dela	Tip	Naziv	za Ø	Št. dela	Tip
<b>Zglobna glava SGS</b>				<b>Vežni element KSG</b>			
	32	9 261	SGS-M10x1,25		32	32 963	KSG-M10x1,25
	40	9 262	SGS-M12x1,25		40	32 964	KSG-M12x1,25
	50	9 263	SGS-M16x1,5		50	32 965	KSG-M16x1,5
	63				63		
	80	9 264	SGS-M20x1,5		80	32 966	KSG-M20x1,5
	100				100		
<b>Viličasta glava SGA</b>				<b>Vežni element KSZ</b>			
	32	32 954	SGA-M10x1,25		32	36 125	KSZ-M10x1,25
	40	10 767	SGA-M12x1,25		40	36 126	KSZ-M12x1,25
	50	10 768	SGA-M16x1,5		50	36 127	KSZ-M16x1,25
	63				63		
	80	10 769	SGA-M20x1,5		80	36 128	KSZ-M20x1,25
	100				100		
<b>Viličasta glava SG</b>				<b>Flexo vez FK</b>			
	32	6 144	SG-M10x1,25		32	6 140	FK-M10x1,25
	40	6 145	SG-M12x1,25		40	6 141	FK-M12x1,25
	50	6 146	SG-M16x1,5		50	6 142	FK-M16x1,5
	63				63		
	80	6 147	SG-M20x1,5		80	6 143	FK-M20x1,5
	100				100		

Podatki za naročanje – vodilne enote					Podatkovni listi → 1 / 10.4-2		
	za Ø	Gib	s krogličnimi vodili		z drsnimi vodili		
	[mm]	[mm]	Št. dela	Tip	Št. dela	Tip	
	32	10 ... 500	33 484	FEN-32-...-KF	19 171	FEN-32-...	
	40		33 485	FEN-40-...-KF	19 172	FEN-40-...	
	50		33 486	FEN-50-...-KF	19 173	FEN-50-...	
	63		33 487	FEN-63-...-KF	19 174	FEN-63-...	
	80		33 488	FEN-80-...-KF	19 175	FEN-80-...	
	100		33 489	FEN-100-...-KF	19 176	FEN-100-...	

 Osnovni program izdelkov





# Standardni valji DNU/DNUL, DIN ISO 6431

Pribor



FESTO



Podatki za naročanje – približevalna stikala kvadratne oblike, magnetorezistivna						Podatkovni listi → 1 / 10.2-81	
Montaža	Izhod	Električni priključek		Dolžina kabla [m]	Št. dela	Tip	
		Kabel	Vtič M8				
	s priborom	PNP	3-žilni	–	2,5	151 683	SMT0-1-PS-K-LED-24-C
			–	3-polni	–	151 685	SMT0-1-PS-S-LED-24-C
		NPN	3-žilni	–	2,5	151 684	SMT0-1-NS-K-LED-24-C
			–	3-polni	–	151 686	SMT0-1-NS-S-LED-24-C

Podatki za naročanje – mejna stikala kvadratne oblike, magnetna Reed						Podatkovni listi → 1 / 10.2-81	
Montaža	Električni priključek	Dolžina kabla [m]	Št. dela	Tip			
					Kabel	Vtič M8	
	s priborom	3-žilni	–	2,5	30 459	SME0-1-LED-24-B	
		3-žilni	–	5,0	151 672	SME0-1-LED-24-K5-B	
		–	3-polni	–	150 848	SME0-1-S-LED-24-B	

Podatki za naročanje – pritrdilni sklop za mejna stikala SME0/SMT0-1				Podatkovni listi → 1 / 10.2-98	
za Ø	Montaža	Št. dela	Tip		
	32 ... 50 mm	na profilni cevi valja	36 173	SMBU-1-B	
	63 ... 100 mm		36 174	SMBU-2-B	

Podatki za naročanje – približevalna stikala kvadratne oblike, pnevmatična				Podatkovni listi → 1 / 10.2-81	
Montaža	Pnevmatični priključek	Št. dela	Tip		
Potni ventil 3/2, zaprt osnovni položaj					
	s priborom	Vtični priključek za notranji Ø cevi 3 mm	31 008	SMPO-1-H-B	

Podatki za naročanje – pritrdilni sklop za približevalna stikala SMPO-1				Podatkovni listi → 1 / 10.2-98	
za Ø	Montaža	Št. dela	Tip		
	32 mm	neposredno na profilni cevi valja	150 216	SMBU-1-H-32	
	63 ... 100 mm		36 174	SMBU-2-B	
	32 ... 100 mm	z objemko na profilni cevi valja	151 226	SMBS-2	

Podatki za naročanje – vtičnice						Podatkovni listi → 1 / 10.2-110	
Montaža	Izhod	Priključek		Dolžina kabla [m]	Št. dela	Tip	
		PNP	NPN				
Ravna vtičnica							
	Matica M8	■	■	3-polni	2,5	159 420	SIM-M8-3GD-2,5-PU
					5	159 421	SIM-M8-3GD-5-PU
Vtičnica, zveržena							
	Matica M8	■	■	3-polni	2,5	159 422	SIM-M8-3WD-2,5-PU
					5	159 423	SIM-M8-3WD-5-PU

 Osnovni program izdelkov

