

## Spindle axes EGC-HD-BS, with heavy-duty guide

**FESTO**

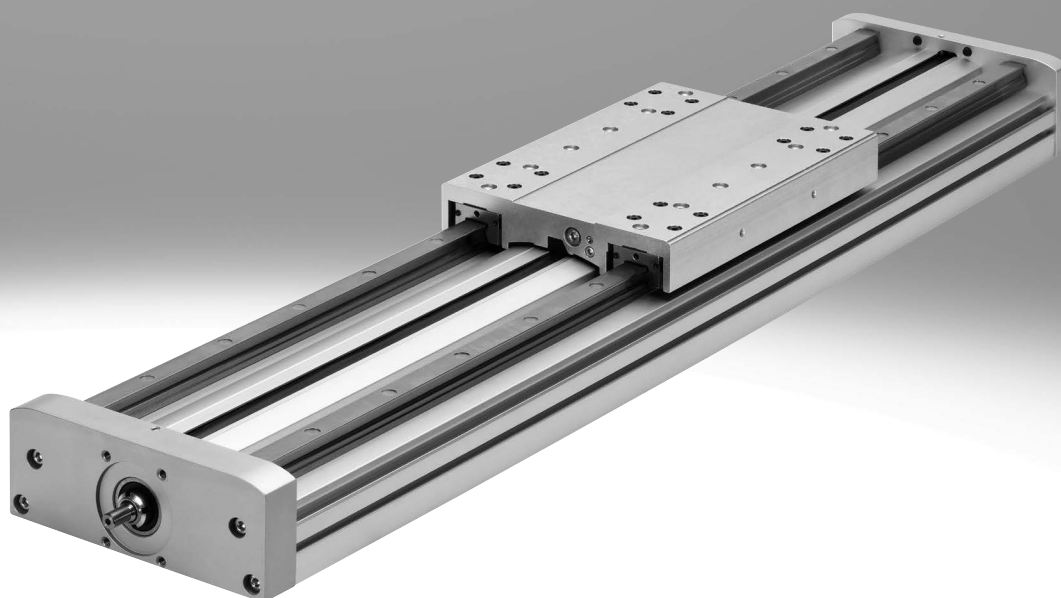

Selection aid

Overview of toothed belt and spindle axes

Toothed belt axes

- Speeds of up to 10 m/s
- Acceleration of up to 50 m/s<sup>2</sup>
- Repetition accuracy of up to ±0.08 mm
- Strokes of up to 8500 mm (longer strokes on request)
- Flexible motor mountings

Spindle axes

- Speeds of up to 2 m/s
- Acceleration of up to 20 m/s<sup>2</sup>
- Repetition accuracy of up to ±0.003 mm
- Strokes of up to 3000 mm

Coordinate system

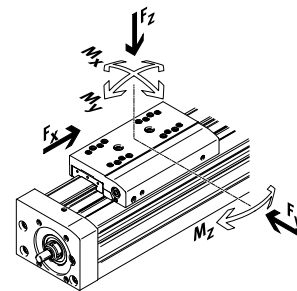

Toothed belt axes

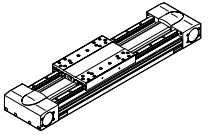
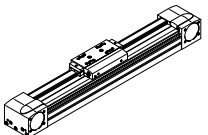
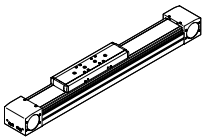
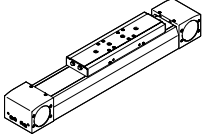
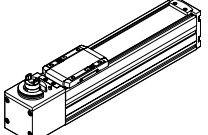
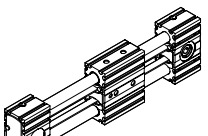
Type	F <sub>x</sub> [N]	v [m/s]	M <sub>x</sub> [Nm]	M <sub>y</sub> [Nm]	M <sub>z</sub> [Nm]	Characteristics
<b>Heavy-duty recirculating ball bearing guide</b>						
<b>EGC-HD-TB</b> 	450 1000 1800	3 5 5	140 300 900	275 500 1450	275 500 1450	<ul style="list-style-type: none"> <li>• Flat drive unit with rigid, closed profile</li> <li>• Precision DUO guide rail with high load capacity</li> <li>• Ideal as a base axis for linear gantries and cantilever axes</li> </ul>
<b>Recirculating ball bearing guide</b>						
<b>EGC-TB-KF</b> 	50 100 350 800 2500	3 5 5 5 5	3.5 16 36 144 529	10 132 228 680 1820	10 132 228 680 1820	<ul style="list-style-type: none"> <li>• Rigid, closed profile</li> <li>• Precision guide rail with high load capacity</li> <li>• Small drive pinions reduce required driving torque</li> <li>• Space-saving position sensing</li> </ul>
<b>ELGA-TB-KF</b> 	350 800 1300 2000	5 5 5 5	16 36 104 167	132 228 680 1150	132 228 680 1150	<ul style="list-style-type: none"> <li>• Internal guide and toothed belt</li> <li>• Precision guide rail with high load capacity</li> <li>• Guide and toothed belt protected by cover strip</li> <li>• High feed forces</li> </ul>
<b>ELGA-TB-KF-F1</b> 	260 600 1000	5 5 5	16 36 104	132 228 680	132 228 680	<ul style="list-style-type: none"> <li>• Suitable for use in the food zone</li> <li>• "Clean look": smooth, easy-to-clean surfaces</li> <li>• Internal guide and toothed belt</li> <li>• Precision guide rail with high load capacity</li> <li>• Guide and toothed belt protected by cover strip</li> </ul>
<b>ELGC-TB-KF</b> 	75 120 250	1.2 1.5 1.5	5.5 29.1 59.8	4.7 31.8 56.2	4.7 31.8 56.2	<ul style="list-style-type: none"> <li>• Internal guide and toothed belt</li> <li>• Precision guide rail with high load capacity</li> <li>• Guide and toothed belt protected by cover strip</li> </ul>
<b>ELGR-TB</b> 	50 100 350	3 3 3	2.5 5 15	20 40 124	20 40 124	<ul style="list-style-type: none"> <li>• Cost-optimised rod guide</li> <li>• Ready-to-install unit</li> <li>• Linear ball bearings with high load capacity for dynamic operation</li> </ul>

## Selection aid

## Overview of toothed belt and spindle axes

## Toothed belt axes

- Speeds of up to 10 m/s
- Acceleration of up to 50 m/s<sup>2</sup>
- Repetition accuracy of up to ±0.08 mm
- Strokes of up to 8500 mm (longer strokes on request)
- Flexible motor mountings

## Spindle axes

- Speeds of up to 2 m/s
- Acceleration of up to 20 m/s<sup>2</sup>
- Repetition accuracy of up to ±0.003 mm
- Strokes of up to 3000 mm

## Coordinate system

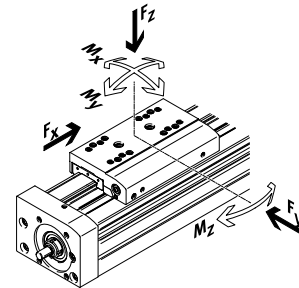

## Toothed belt axes

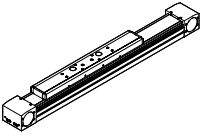
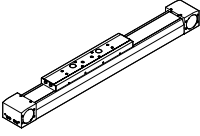
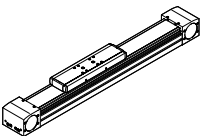
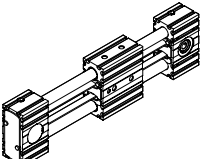
Type	$F_x$ [N]	$v$ [m/s]	$M_x$ [Nm]	$M_y$ [Nm]	$M_z$ [Nm]	Characteristics
<b>Roller bearing guide</b>						
<b>ELGA-TB-RF</b>						
	350 800 1300	10 10 10	11 30 100	40 180 640	40 180 640	<ul style="list-style-type: none"> <li>• Heavy-duty roller bearing guide</li> <li>• Guide and toothed belt protected by cover strip</li> <li>• Speeds of up to 10 m/s</li> <li>• Lower weight than axes with guide rails</li> </ul>
<b>ELGA-TB-RF-F1</b>						
	260 600 1000	10 10 10	8.8 24 80	32 144 512	32 144 512	<ul style="list-style-type: none"> <li>• Suitable for use in the food zone</li> <li>• "Clean look": smooth, easy-to-clean surfaces</li> <li>• Heavy-duty roller bearing guide</li> <li>• Guide and toothed belt protected by cover strip</li> <li>• Lower weight than axes with guide rails</li> </ul>
<b>Plain-bearing guide</b>						
<b>ELGA-TB-G</b>						
	350 800 1300	5 5 5	5 10 120	30 60 120	10 20 40	<ul style="list-style-type: none"> <li>• Guide and toothed belt protected by cover strip</li> <li>• For simple handling tasks</li> <li>• As a drive component for external guides</li> <li>• Insensitive to harsh ambient conditions</li> </ul>
<b>ELGR-TB-GF</b>						
	50 100 350	1 1 1	1 2.5 1	10 20 40	10 20 40	<ul style="list-style-type: none"> <li>• Cost-optimised rod guide</li> <li>• Ready-to-install unit</li> <li>• Heavy-duty plain bearings for use in harsh ambient conditions</li> </ul>

Selection aid

Overview of toothed belt and spindle axes

Toothed belt axes

- Speeds of up to 10 m/s
- Acceleration of up to 50 m/s<sup>2</sup>
- Repetition accuracy of up to ±0.08 mm
- Strokes of up to 8500 mm (longer strokes on request)
- Flexible motor mountings

Spindle axes

- Speeds of up to 2 m/s
- Acceleration of up to 20 m/s<sup>2</sup>
- Repetition accuracy of up to ±0.003 mm
- Strokes of up to 3000 mm

Coordinate system

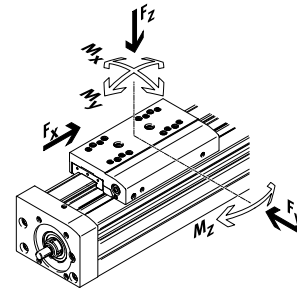

Spindle axes

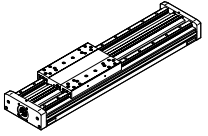
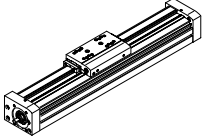
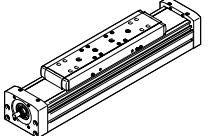
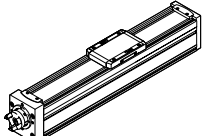
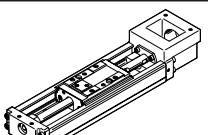
Type	F <sub>x</sub> [N]	v [m/s]	M <sub>x</sub> [Nm]	M <sub>y</sub> [Nm]	M <sub>z</sub> [Nm]	Characteristics
<b>Heavy-duty recirculating ball bearing guide</b>						
<b>EGC-HD-BS</b>						
	400 650 1500	0.5 1.0 1.5	140 300 900	275 500 1450	275 500 1450	<ul style="list-style-type: none"> <li>• Flat drive unit with rigid, closed profile</li> <li>• Precision DUO guide rail with high load capacity</li> <li>• Ideal as a base axis for linear gantries and cantilever axes</li> </ul>
<b>Recirculating ball bearing guide</b>						
<b>EGC-BS-KF</b>						
	400 650 1500 3000	0.5 1.0 1.5 2.0	16 36 144 529	132 228 680 1820	132 228 680 1820	<ul style="list-style-type: none"> <li>• Rigid, closed profile</li> <li>• Precision guide rail with high load capacity</li> <li>• For the highest requirements in terms of feed force and accuracy</li> <li>• Space-saving position sensing</li> </ul>
<b>ELGA-BS-KF</b>						
	650 1600 3400 6400	0.5 1.0 1.5 2.0	16 36 104 167	132 228 680 1150	132 228 680 1150	<ul style="list-style-type: none"> <li>• Internal guide and ball screw</li> <li>• Precision guide rail with high load capacity</li> <li>• For the highest requirements in terms of feed force and accuracy</li> <li>• Guide and ball screw protected by cover strip</li> <li>• Space-saving position sensing</li> </ul>
<b>ELGC-BS-KF</b>						
	40 100 200 350	0.6 0.6 0.8 1.0	1.3 5.5 29.1 59.8	1.1 4.7 31.8 56.2	1.1 4.7 31.8 56.2	<ul style="list-style-type: none"> <li>• Internal guide and ball screw</li> <li>• Guide and ball screw protected by cover strip</li> <li>• Space-saving position sensing</li> </ul>
<b>EGSK</b>						
	57 133 184 239 392	0.33 1.10 0.83 1.10 1.48	13 28.7 60 79.5 231	3.7 9.2 20.4 26 77.3	3.7 9.2 20.4 26 77.3	<ul style="list-style-type: none"> <li>• Spindle axes with maximum precision, compactness and rigidity</li> <li>• Recirculating ball bearing guide and ball screw without caged ball bearings</li> <li>• Standard designs in stock</li> </ul>

## Key features

### At a glance

- New heavy-duty design for:
  - Maximum loads and torques
  - High feed forces and speeds
  - Long service life
- Precision DUO guide rail with high load capacity
- Ideal as a basic axis for linear gantries and cantilever axes
- The spindle axis with integrated ball screw combines high precision and flexible spindle pitches
- In addition to its technical data, the spindle axis also offers an excellent price/performance ratio
- Space-saving position sensing with proximity switch in the profile slot is possible
- Wide range of options for mounting on drives
- Spindle support enables maximum travel speed with all stroke lengths

Flat unit with rigid, closed profile

EGC-HD-125

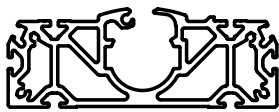

EGC-HD-160

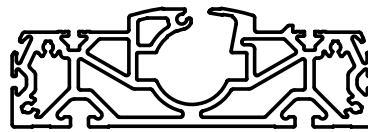

EGC-HD-220

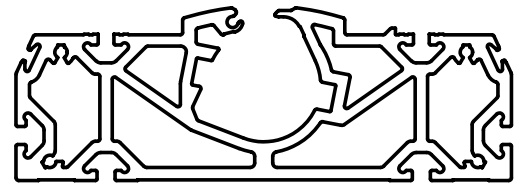

### Slide variants

Standard slide

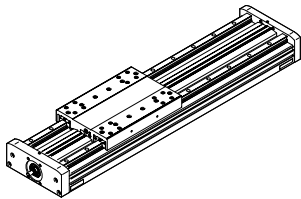

Standard slide, protected

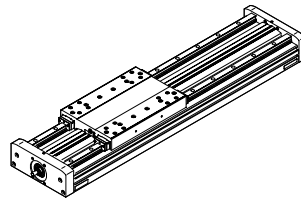

With additional slide

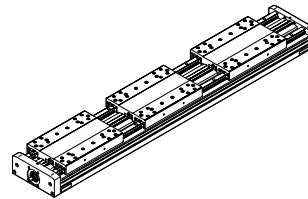

### Guide options

→ Page 22

With central lubrication

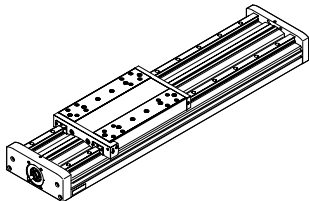

- The lubrication adapters enable the guide and the spindle to be permanently lubricated using semi or fully automatic relubrication devices
- The adapters are suitable for oils and greases
- All lubrication connections must be connected

### Displacement encoder

→ Page 12

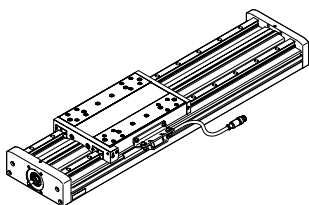



The position of the slide can be sensed directly when using the incremental displacement encoder. This means that all elasticities of the drivetrain can be detected and corrected by the motor controller.

## Key features

### Characteristic values of the axes

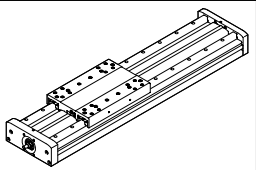
The specifications shown in the table are maximum values.  
The precise values for each of the variants can be found in the relevant data sheet in the catalogue.

Design	Size	Working stroke [mm]	Speed [m/s]	Repetition accuracy [mm]	Max. feed force [N]	Guide characteristics				
						Forces and torques				
						Fy [N]	Fz [N]	Mx [Nm]	My [Nm]	Mz [Nm]
	125	50 ... 900	0.5	±0.02	400	3650	3650	140	275	275
	160	50 ... 1900	1	±0.02	650	5600	5600	300	500	500
	220	50 ... 2400	1.5	±0.02	1500	13000	13000	900	1450	1450

 **Note**  
Engineering software  
Electric Motion Sizing  
[www.festo.com/x/electric-motion-sizing](http://www.festo.com/x/electric-motion-sizing)

### Complete system comprising spindle axis, motor, motor controller and motor mounting kit

Spindle axis with recirculating ball bearing guide



#### Motor



Servo motor:  
EMMT-AS, EMME-AS, EMMS-AS  
Stepper motor:  
EMMS-ST

 **Note**  
A range of specially adapted complete solutions is available for the spindle axis EGC and the motors.

#### Servo drives



Servo drive:  
CMMT-AS  
Servo drive for extra-low voltage:  
CMMT-ST

#### Motor mounting kit

Axial kit → page 32

Parallel kit → page 37

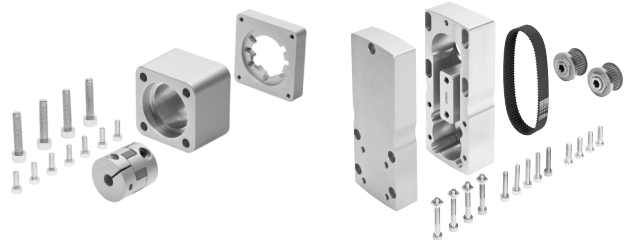

## Type codes

001	Series		016	Slot cover, sensor slot	
EGC	Electric linear axis			Without	
002	Size		...S	1 - 50 pieces	
125	125		017	Slot nut, mounting slot	
160	160			Without	
220	220		...Y	1 ... 99 pieces	
003	Stroke		018	Proximity switch, inductive, slot 8, PNP, N/O contact, cable 7.5 m	
...	50 ... 2400			None	
004	Drive system		...X	1 ... 6 pieces	
BS	Ball screw drive		019	Proximity switch, inductive, slot 8, N/C contact, cable 7.5 m	
005	Spindle pitch		...Z	1 ... 6 pieces	
10P	10 mm		020	Emergency buffer with retaining bracket	
20P	20 mm			Without	
25P	25 mm		...A	1 ... 2 pieces	
006	Spindle support		021	Proximity switch, inductive, M8, PNP, N/O contact, cable 2.5 m	
	None			Without	
S	With		...O	1 ... 99 pieces	
007	Stroke reserve [mm]		022	Proximity switch, inductive, M8, PNP, N/C contact, cable 2.5 m	
...	0 ... 999			None	
008	Slide		...P	1 ... 99 pieces	
GK	Standard slide		023	Proximity switch, inductive, M8, PNP, N/C contact, M8 plug	
GP	Standard slide, protected			None	
009	Additional slide left		...R	1 ... 99 pieces	
	None		024	Proximity switch, inductive, M8, PNP, N/O contact, M8 plug	
KL	Additional slide, standard, left			Without	
010	Additional slide, right		...W	1 ... 99 pieces	
	None		025	Connecting cable 2.5 m, M8, 3-wire	
KR	Additional slide standard, right			None	
011	Lubrication function		...V	1 ... 99 pieces	
	None		026	Cable clip	
C	Lubrication adapter			None	
012	Displacement encoder		10CL	10 pieces	
	None		20CL	20 pieces	
M1	With displacement encoder, incremental, resolution 2.5 µm		30CL	30 pieces	
M2	With displacement encoder, incremental, resolution 10 µm		40CL	40 pieces	
013	Displacement encoder attachment position		50CL	50 pieces	
	None		60CL	60 pieces	
F	Front		70CL	70 pieces	
B	Rear		80CL	80 pieces	
014	Profile mounting		90CL	90 pieces	
...M	1 - 50 pieces		027	Operating instructions	
015	Slot cover, mounting slot			With operating instructions	
	Without		DN	Without operating instructions	
...B	1 - 50 pieces				

Peripherals overview

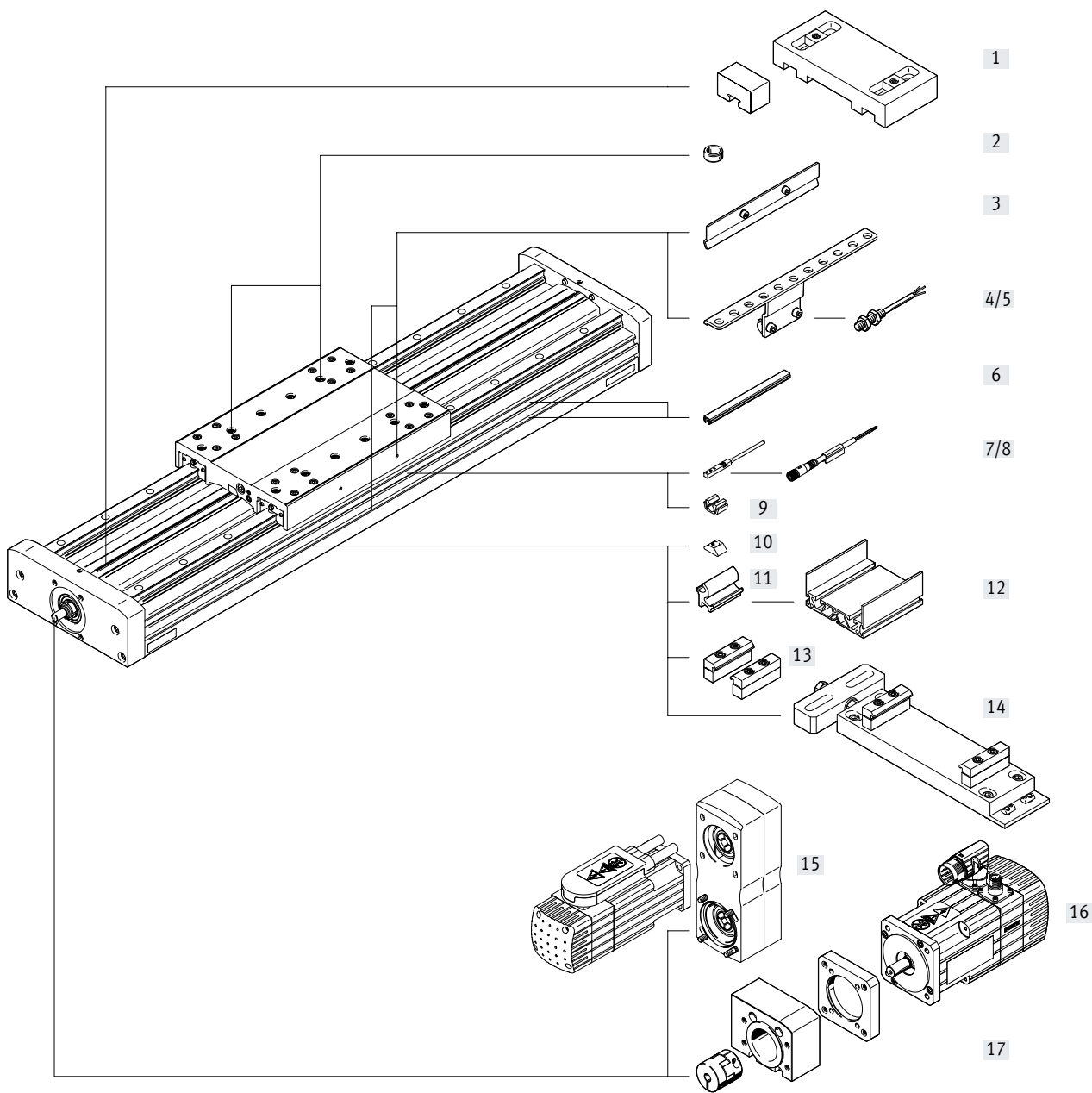





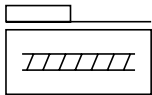

## Peripherals overview

Variants and accessories			
Type/order code	Description		→ Page/Internet
[1] Emergency buffer with retaining bracket A	For avoiding damage at the end stop in the event of a malfunction		43
[2] Centring pin/sleeve ZBS, ZBH	<ul style="list-style-type: none"> <li>• For centring loads and attachments on the slide</li> <li>• Included in the scope of delivery: <ul style="list-style-type: none"> <li>– For size 125: 2x ZBS-5, 2x ZBH-9</li> <li>– For size 160, 220: 2x ZBH-9</li> </ul> </li> </ul>		43
[3] Switch lug X, Z, O, P, W, R	For sensing the slide position		41
[4] Sensor bracket O, P, W, R	Adapter for mounting the inductive proximity switches (round design) on the axis		42
[5] Proximity switch, M8 O, P, W, R	<ul style="list-style-type: none"> <li>• Inductive proximity switch, round design</li> <li>• The order code O, P, W, R includes 1 switch lug and max. 2 sensor brackets in the scope of delivery</li> </ul>		45
[6] Slot cover B, S	• For protection against contamination		43
[7] Proximity switch, T-slot X, Z	<ul style="list-style-type: none"> <li>• Inductive proximity switch, for T-slot</li> <li>• The order code X, Z includes 1 switch lug in the scope of delivery</li> </ul>		44
[8] Connecting cable V	For proximity switch (order code W and R)		45
[9] Clip CL	For mounting the proximity switch cable in the slot		43
[10] Slot nut Y	For mounting attachments		43
[11] Adapter kit DHAM	For mounting the support profile on the axis		44
[12] Support profile HMIA	For mounting and guiding an energy chain		44
[13] Profile mounting M	For mounting the axis on the profile		39
[14] Adjusting kit EADC-E16	For mounting the axis on a vertical surface. Once mounted, the axis can be aligned horizontally		40
[15] Parallel kit EAMM-U	For parallel motor mounting, can only be attached upwards or downwards (comprising: housing, clamping sleeve, toothed belt pulley, toothed belt)		37
[16] Motor EMME, EMMS	Motors specially matched to the axis, with or without gear unit, with or without brake		32
[17] Axial kit EAMM-A	For axial motor mounting (comprising: coupling, coupling housing and motor flange)		32

Data sheet



-  Size  
125 ... 220
-  Stroke length  
0 ... 2400 mm
-  [www.festo.com](http://www.festo.com)



General technical data						
Size		125	160	220		
Spindle pitch	[mm/rev]	10	10	20	10	25
Design	Electromechanical axis with ball screw					
Guide	Recirculating ball bearing guide					
Mounting position	Any					
Working stroke	[mm]	50 ... 900	50 ... 1900	50 ... 2400		
Max. feed force $F_x^{1)}$	[N]	400	650	1500		
No-load torque at min. travel speed						
EGC...-	[Nm]	0.3	0.5	0.5	1.5	1.5
EGC...-S	[Nm]	0.3	0.5	0.5	1.5	1.5
	[m/s]	0.05	0.1	0.1	0.2	0.2
No-load torque at max. travel speed						
EGC...-	[Nm]	0.45	0.75	0.75	2.25	2.25
EGC...-S	[Nm]	0.45	0.75	0.75	2.25	2.25
	[m/s]	0.5	0.5	1.0	0.6	1.5
Max. radial force <sup>2)</sup>	[N]	220	250	250	500	500
Max. rotational speed <sup>3)</sup>	[rpm]	3000	3000	3000	3600	3600
Max. acceleration	[m/s <sup>2</sup> ]	15				
Repetition accuracy	[mm]	±0.02				

- 1) The feed force affects the service life. (→ page 15)
- 2) At the driving shaft
- 3) Rotational speed and velocity are stroke-dependent

Operating and environmental conditions		
Ambient temperature	[°C]	-10 ... +60
Degree of protection	IP40	
Duty cycle	[%]	100

Weight [g]			
Size	125	160	220
Basic weight with 0 mm stroke <sup>1)</sup>	4123	7210	19137
Additional weight per 10 mm stroke	90	138	250
Slide			
EGC ...- GK	1049	2080	5826
EGC...-GK-C	1189	2352	6374
EGC ...- GP	-	2346	6325
Additional slide			
EGC ...- GK	978	1963	5505
EGC...-GK-C	1118	2235	6053
EGC ...- GP	-	2035	5584

- 1) Incl. slide

## Data sheet

Spindle		125		160		220	
Size		125		160		220	
Diameter	[mm]	12		15		25	
Pitch	[mm/rev]	10		10	20	10	25

Mass moment of inertia		125		160		220	
Size		125		160		220	
Spindle pitch	[mm/rev]	10		10	20	10	25
$J_0$	[kg mm <sup>2</sup> ]	6.06		13.94	29.74	106.78	184.26
$J_H$ per metre stroke	[kg mm <sup>2</sup> /m]	14.20		34.59	34.59	275.64	275.64
$J_L$ per kg payload	[kg mm <sup>2</sup> /kg]	2.53		2.53	10.13	2.53	15.83
$J_W$ Additional slide	[kg mm <sup>2</sup> ]	2.25		4.69	18.77	13.20	82.48

The mass moment of inertia  $J_A$  of the entire axis is calculated as follows:

$$J_A = J_0 + J_W + J_H \times \text{working stroke [m]} + J_L \times m_{\text{payload [kg]}}$$

## Materials

Sectional view

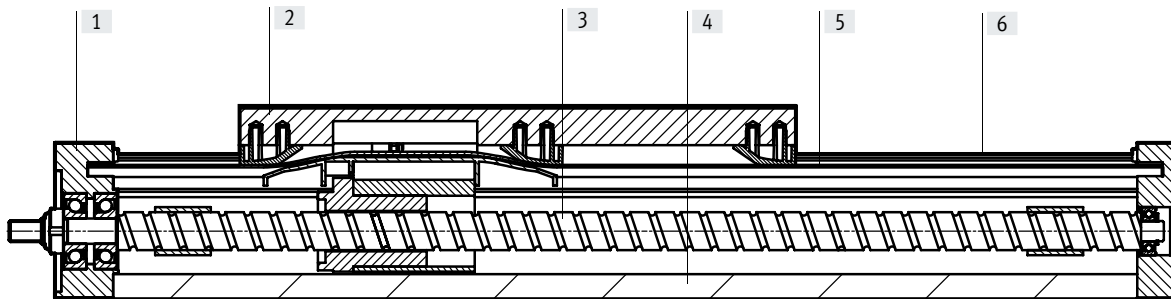

Axis		
[1]	Drive cover	Anodised wrought aluminium alloy
[2]	Slide	Anodised wrought aluminium alloy
[3]	Spindle	Steel
[4]	Profile	Anodised wrought aluminium alloy
[5]	Cover strip	Polyurethane
[6]	Guide rail	Coated and corrosion-resistant steel
Note on materials		RoHS-compliant
		Contains paint-wetting impairment substances

## Data sheet

Technical data – Displacement encoder		EGC...-M1		EGC...-M2		Dimensions → page 29
Type						
Resolution	[μm]	2.5		10		
Max. travel speed with displacement encoder	[m/s]	4		4		
Encoder signal		5 V TTL; A/A, B/B; reference signal (N/N) cyclically every 5 mm (zero pulse)				
Signal output		Line driver, alternating, resistant to sustained short circuit				
Electrical connection		8-pin plug, round design, M12				
Cable length	[mm]	160				
Operating and environmental conditions – Displacement encoder system						
Ambient temperature	[°C]	-10 ... +70				
Degree of protection		IP64				
CE marking (see declaration of conformity)		To EU EMC Directive <sup>1)</sup>				

1) For information about the area of use, see the EC declaration of conformity at: [www.festo.com/sp](http://www.festo.com/sp) → Certificates.  
If the devices are subject to usage restrictions in residential, commercial or light-industrial environments, further measures for the reduction of the emitted interference may be necessary.

### Application information

- 1) The displacement encoder contains paint-wetting impairment substances.
- 2) The spindle axis with displacement encoder is not designed for the following application examples:

- Magnetic field

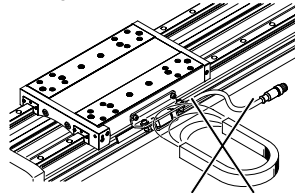

- Welding application

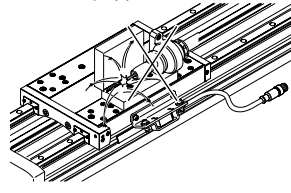

## Data sheet

## Characteristic load values

The indicated forces and torques refer to the slide surface. The point of application of force is the point where the centre of the guide and the longitudinal centre of the slide intersect. These values must not be exceeded during dynamic operation. Special attention must be paid to the deceleration phase.

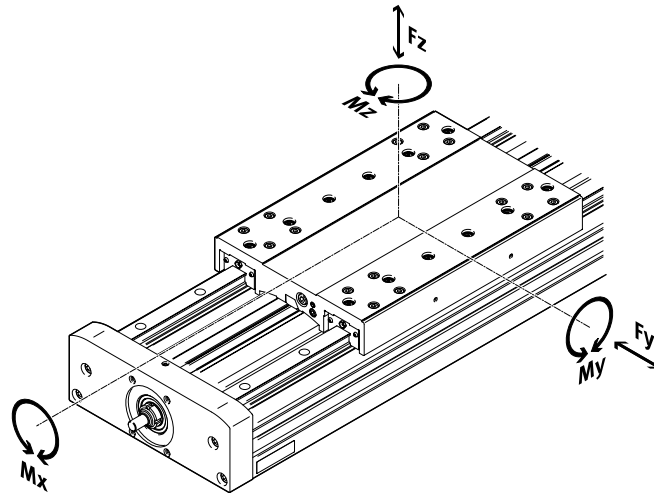

## Max. permissible forces and torques for a service life of 5000 km

Size	125	160	220
$F_{y_{max}}$ [N]	3650	5600	13000
$F_{z_{max}}$ [N]	3650	5600	13000
$M_{x_{max}}$ [Nm]	140	300	900
$M_{y_{max}}$ [Nm]	275	500	1450
$M_{z_{max}}$ [Nm]	275	500	1450

## Basic load ratings

Size	125	160	220		
Spindle pitch [mm/rev]	10	10	20	10	25
<b>Ball screw</b>					
Dynamic $C_{dyn,BSD}$ [N]	4000	6800	5700	14100	12700

 Note

For a guide system to have a service life of 5000 km, the load comparison factor must have a value of  $f_v \leq 1$ , based on the maximum permissible forces and torques for a service life of 5000 km.

If the axis is subjected to two or more of the indicated forces and torques simultaneously, the following equation must be satisfied in addition to the indicated maximum loads:

Calculating the load comparison factor:

$$f_v = \frac{|F_{y1}|}{F_{y2}} + \frac{|F_{z1}|}{F_{z2}} + \frac{|M_{x1}|}{M_{x2}} + \frac{|M_{y1}|}{M_{y2}} + \frac{|M_{z1}|}{M_{z2}} \leq 1$$

$F_1/M_1$  = dynamic value

$F_2/M_2$  = maximum value

## Data sheet

### Service life of the guide

The service life of the guide depends on the load. To be able to make a statement as to the service life of the guide, the graph below plots the load comparison factor  $f_v$  against the service life.

These values are only theoretical. You must consult your local Festo contact for a load comparison factor  $f_v$  greater than 1.5.

#### Load comparison factor $f_v$ as a function of service life

Example:

A user wants to move an X kg load. Using the formula (→ page 13) gives a value of 1.5 for the load comparison factor  $f_v$ . According to the graph, the guide would have a service life of approx. 1500 km. Reducing the acceleration reduces the  $M_z$  and  $M_y$  values. A load comparison factor  $f_v$  of 1 now gives a service life of 5000 km.

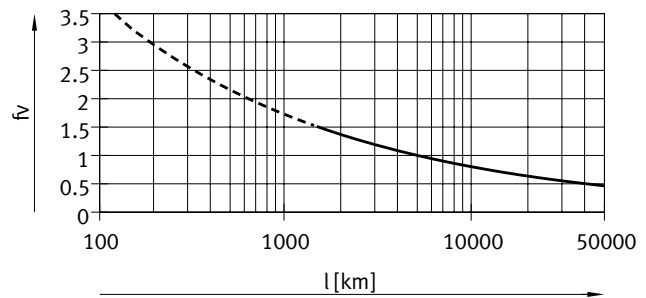

#### Note

Engineering software  
Electric Motion Sizing  
[www.festo.com/x/electric-motion-sizing](http://www.festo.com/x/electric-motion-sizing)

The engineering software can be used to calculate the guide workload for a service life of 5000 km.

$f_v > 1.5$  are only theoretical comparison values for the recirculating ball bearing guide.

### Comparison of the characteristic load values for 5000 km with dynamic forces and torques of recirculating ball bearing guides

The characteristic load values of bearing guides are standardised to ISO and JIS using dynamic and static forces and torques. These forces and torques are based on an expected service life of the guide system of 100 km to ISO or 50 km to JIS. As the characteristic load values are dependent on the service life, the maximum permissible forces and torques for a 5000 km service life cannot be compared with the dynamic forces and torques of bearing guides to ISO/JIS.

To make it easier to compare the guide capacity of linear axes EGC with bearing guides, the table below lists the theoretically permissible forces and torques for a calculated service life of 100 km. This corresponds to the dynamic forces and torques to ISO.

These 100 km values have been calculated mathematically and are only to be used for comparing with dynamic forces and torques to ISO. The drives must not be loaded with these characteristic values as this could damage the axes.

#### Max. permissible forces and torques for a theoretical service life of 100 km (from a guide perspective only)

Size		125	160	220
$F_{y_{max}}$	[N]	13447	20631	47892
$F_{z_{max}}$	[N]	13447	20631	47892
$M_{x_{max}}$	[Nm]	516	1105	3316
$M_{y_{max}}$	[Nm]	1013	1842	5342
$M_{z_{max}}$	[Nm]	1013	1842	5342

## Data sheet

### Service life of the spindle

- The service life of the spindle axis depends on the service life of the guide (→ page 14) and of the ball screw.  
The operating coefficient plays a considerable role in determining the possible service life. This can be determined with the help of the table (→ page 16)
- The service life ends when the maximum number of switching cycles or maximum running performance has been reached:
  - 5 million switching cycles or 5000 km running performance
- The distance between the foremost and rearmost positions must be at least 2.5 times the spindle pitch per travel cycle
- The specifications for running performance are based on experimentally determined and theoretically calculated data (at room temperature).  
The running performance that can be achieved in practice can deviate considerably from the specified curves under different parameters

### Calculation of the mean feed force $F_{xm}$ with ball screw

$$F_{xm} = \sqrt[3]{\frac{F_{x1}^3 \cdot s_1 + \dots + F_{xn}^3 \cdot s_n}{s_1 + \dots + s_n}}$$

$F_{xm}$  = Mean feed force  
 $F_{x1/n}$  = Feed force of section  
 $s_{1/n}$  = Part of movement cycle that is travel

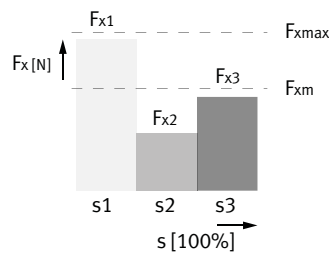

### Mean feed force $F_{xm}$ as a function of running performance L, with an operating coefficient $f_B$ of 1.0, at room temperature

Size 125

Size 160

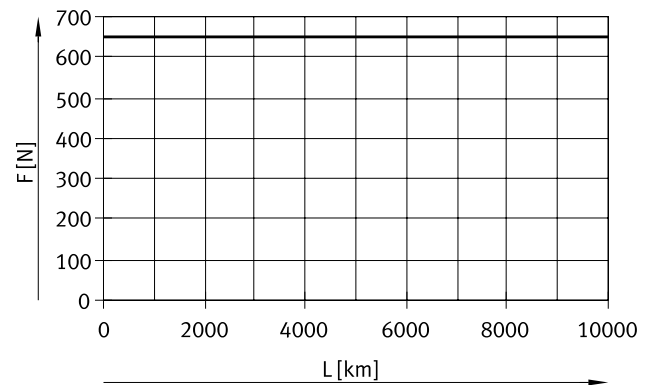
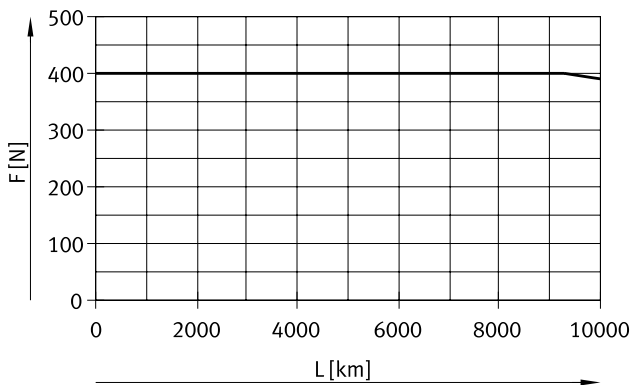

## Data sheet

Mean feed force  $F_{xm}$  as a function of running performance  $L$ , with an operating coefficient  $f_B$  of 1.0, at room temperature  
Size 220

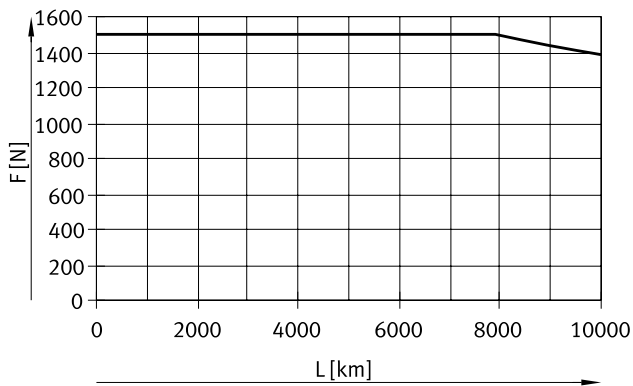

Service life taking into account the operating coefficient

$$L_1 = \frac{L}{f_B^3}$$

$L_{act}$  = Actual service life

$L$  = Target service life

(→ graphs)

$f_B$  = Operating coefficient

Load <sup>1)</sup>	Operating coefficient $f_B$	Application example
None	1.0 ... 1.2	Measuring machine
Light	1.2 ... 1.4	Handling, robotics
Medium	1.4 ... 1.6	Press-in operations
High	1.6 ... 2.0	Construction, agriculture

1) Loads caused by impact, temperature, contamination, shock and vibrations



Data sheet

Velocity v as a function of working stroke l

Size 125

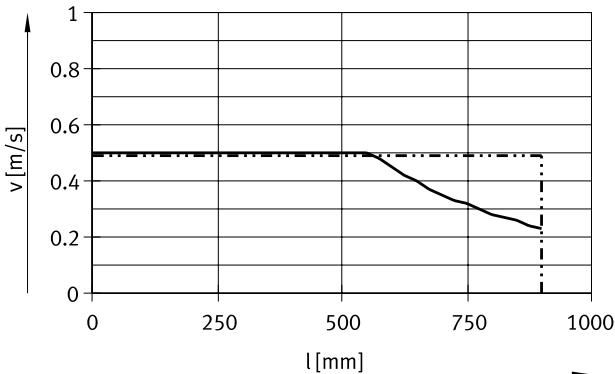

- EGC-HD-10P without spindle support
- - - EGC-HD-10P with spindle support

Size 160

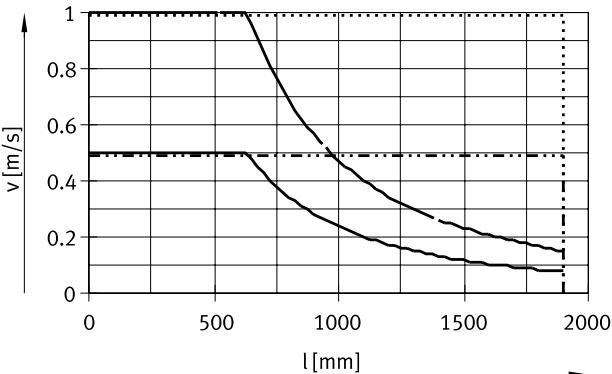

- EGC-HD-10P without spindle support
- - - EGC-HD-10P with spindle support
- · - EGC-HD-20P without spindle support
- · · EGC-HD-20P with spindle support

Size 220

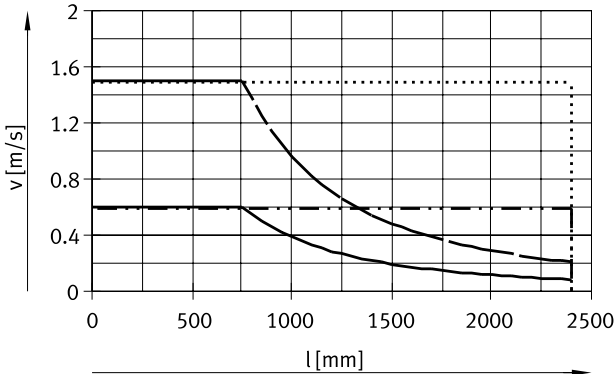

- EGC-HD-10P without spindle support
- - - EGC-HD-10P with spindle support
- · - EGC-HD-25P without spindle support
- · · EGC-HD-25P with spindle support

Velocity v as a function of rotational speed n

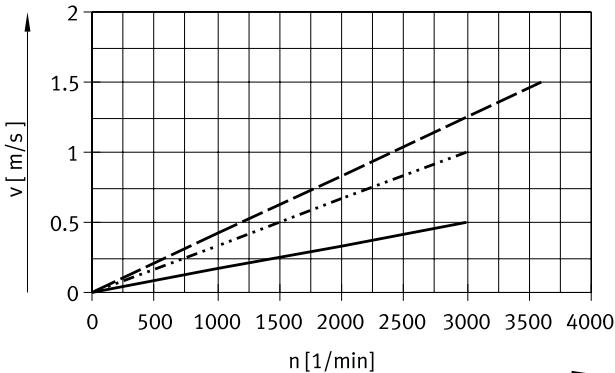

**Note**  
 Rotational speed is stroke-dependent.  
 Note maximum rotational speed.

- EGC-HD-125/160/220-10P
- - - EGC-HD-160-20P
- · - EGC-HD-220-25P

Data sheet

Max. acceleration  $a$  as a function of payload  $m$

Size 125

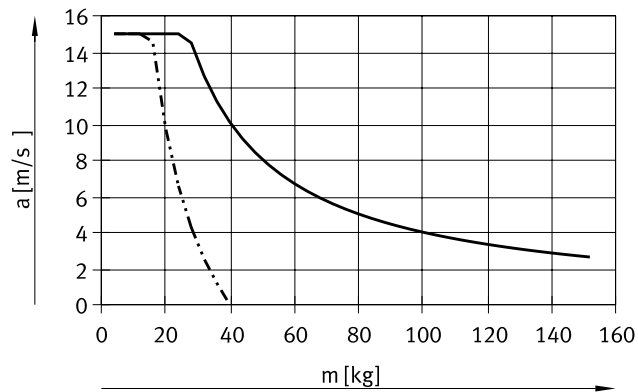

Size 160

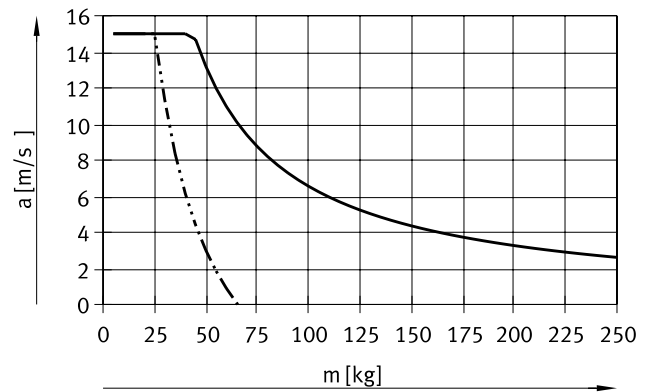

Size 220

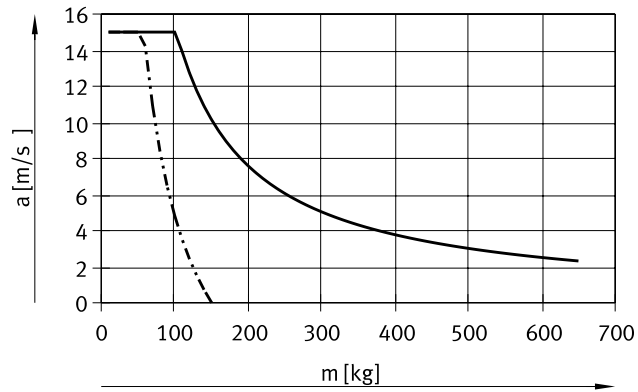

— Horizontal mounting position  
 - - - Vertical mounting position

Data sheet

Theoretical feed force F as a function of input torque M

Size 125

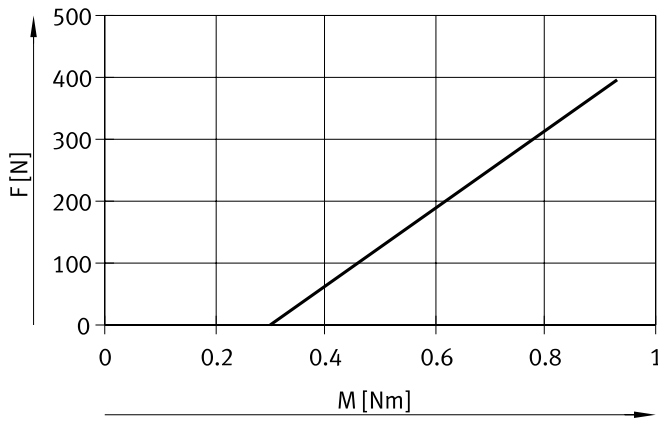

— EGC-HD-10P

Size 160

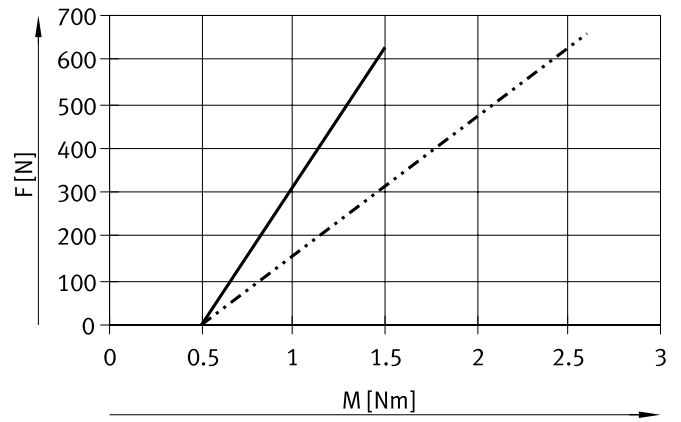

— EGC-HD-160-10P

- - - EGC-HD-160-20P

Size 220

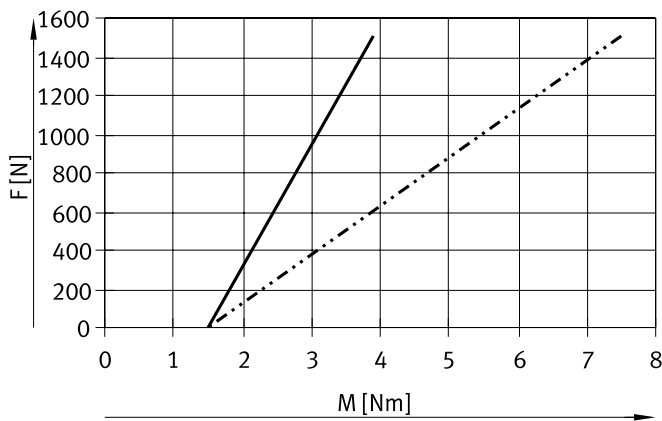

— EGC-HD-220-10P

- - - EGC-HD-220-25P

## Data sheet

### Stroke reserve

Stroke length	Stroke reserve		
The selected stroke corresponds in principle to the required working stroke. The variant GK does not have a long-term lubrication unit on the guide. These variants therefore have an additional safety distance between the drive cover and slide that is not designated as part of the working stroke.	If a safety distance (similar to GK) between the drive cover and slide is required for the variant GP, this can be defined using the modular product system via the "stroke reserve" feature. With the variants GK, the stroke reserve and safety distance are added for each end position.	<ul style="list-style-type: none"> <li>The stroke reserve length can be freely selected</li> <li>The sum of the stroke length and 2x stroke reserve must not exceed the maximum working stroke</li> </ul>	<b>Example:</b> Type: EGC-HD-125-500-BS-20H-... Working stroke = 500 mm 2x stroke reserve = 40 mm  Total stroke = 540 mm (540 mm = 500 mm + 2x 20 mm)
Size	125	160	220
L = safety distance with GK (per end position) [mm]	12.5	15.5	20

### Working stroke reduction

For standard slide GK/GP with additional slide KL/KR

- In the case of a spindle axis with additional slide, the working stroke is reduced by the length of the additional slide L17 and the distance between the two slides L18
- If the variant GP is ordered, the additional slide is also protected
- If the variant GK-C is ordered, the additional slide is also supplied with lubrication adapters

L17 = Slide length  
 L17 = Additional slide length  
 L = Distance between the two slides  
 [1] Additional slide

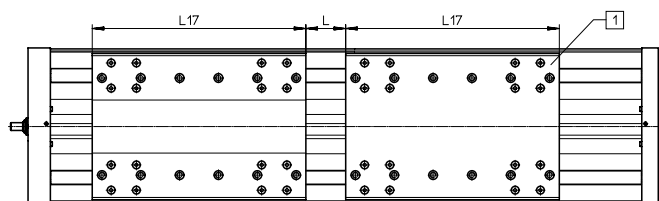

#### Example:

Type: EGC-HD-220-1000-BS-...-GP-KL/KR  
 L = 100 mm

Working stroke = 1000 mm – 328 mm – 100 mm = 572 mm

### Dimensions – Additional slide

Size	125			160			220		
Variant	GK	GK-C	GK	GK-C	GP	GK	GK-C	GP	
Length L17 [mm]	202	220	220	244	250	302	327.6	328	

### Working stroke reduction per side

With integrated emergency buffer NPE with retaining bracket EAYH-L2

- With a spindle axis, the working stroke is reduced by the total dimension of the emergency buffer and retaining bracket.

Size	125		160		220	
With emergency buffer [mm]	65		93		98	

## Data sheet

### 2nd moments of area

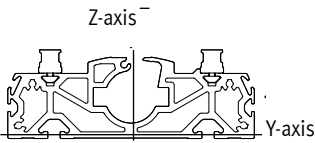

Size		125	160	220
$I_y$	[mm <sup>4</sup> ]	$7.15 \times 10^5$	$13.5 \times 10^5$	$55.7 \times 10^5$
$I_z$	[mm <sup>4</sup> ]	$41.1 \times 10^5$	$101 \times 10^5$	$352 \times 10^5$

### Maximum permissible support span L (without profile mounting) as a function of force F

In order to limit deflection in the case of large strokes, the axis may need to be supported.

The following graphs can be used to determine the maximum permissible support span L as a function of force F acting on the axis. The deflection is  $f = 0.5 \text{ mm}$ .

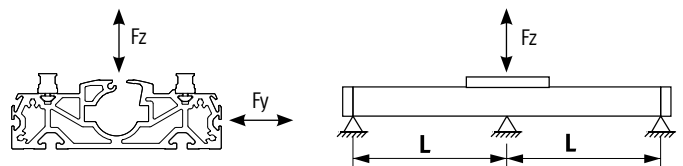

Force  $F_y$

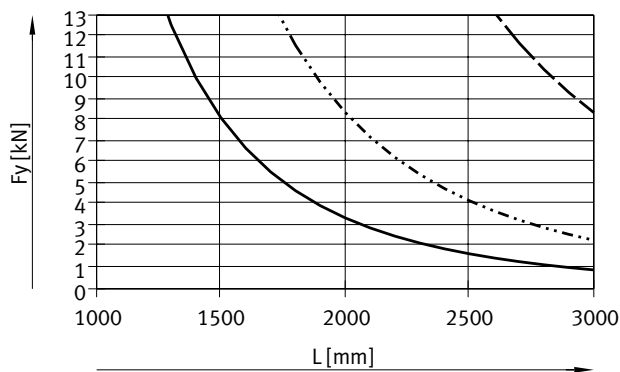

Force  $F_z$

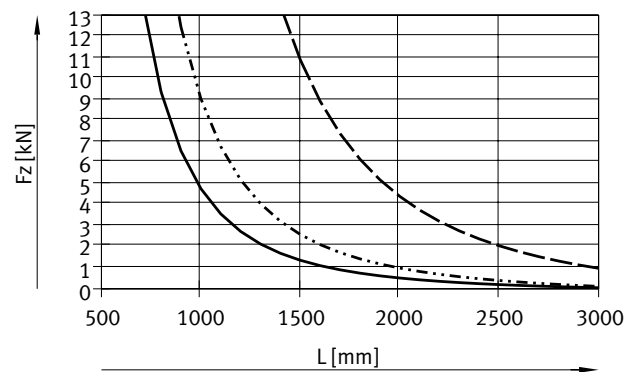

- EGC-HD-125
- EGC-HD-160
- - - EGC-HD-220

### Recommended deflection limits

Adherence to the following deflection limits is recommended so as not to impair the functionality of the axes.

Greater deformation can result in increased friction, greater wear and reduced service life.

Size	Dynamic deflection (moving load)	Static deflection (stationary load)
125 ... 220	0.05% of the axis length, max. 0.5 mm	0.1% of the axis length

## Data sheet

### Central lubrication

The lubrication adapters enable the guide and the spindle of the spindle axis EGC-HD-BS to be permanently lubricated in applications in humid or wet ambient conditions using semi or fully automatic relubrication devices.

- For size 125, 160, 220
- The modules are suitable for oils and greases.
- The dimensions of the spindle axis EGC-HD-BS are the same with and without central lubrication modules.
- All lubrication connections must be connected
- The central lubrication system is connected by means of the three connections at the front and the two at the rear
- Can be used in combination with:
  - Standard slide GK
  - Additional slide KL, KR
- Cannot be used in combination with:
  - Standard slide, protected GP

Slide dimensions

→ page 28

Order code C in the modular product system → page 31

### Design of a central lubrication system

A central lubrication system requires various additional components. The illustration shows different options (using a hand pump, pneumatic container pump or electric container pump) required as a minimum for designing a central lubrication system. Festo does not sell these additional components; however, they can be obtained from the following companies:

- Lincoln
- Bielomatik
- SKF (Vogel)

Festo recommends these companies because they can supply all the necessary components.

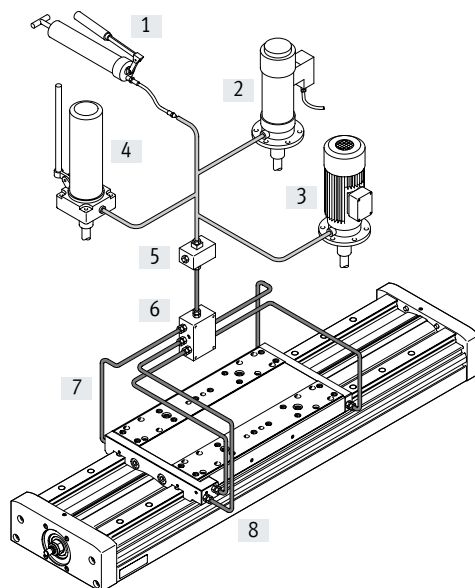

- [1] Hand pump
- [2] Pneumatic container pump
- [3] Electric container pump
- [4] Manually operated container pump
- [5] Nipple block
- [6] Distributor block
- [7] Tubing or piping
- [8] Fittings

Data sheet

Dimensions

Download CAD data → [www.festo.com](http://www.festo.com)

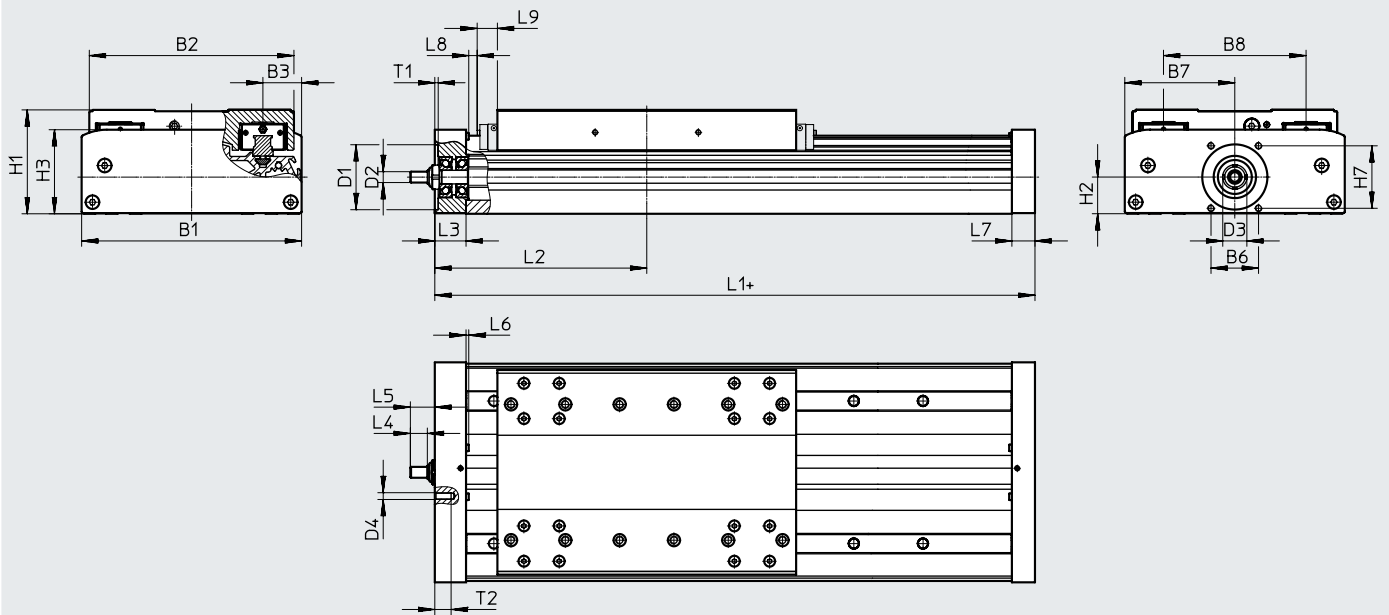

+ = plus stroke length + 2x stroke reserve

L9 With GP: dimension for long-term lubrication unit → page 20

Size	B1	B2	B3	B6	B7	B8	D1 ∅ H7	D2 ∅ h6
125	124	120	21	29	62	80	38	6
160	162	150.7	27.5	35	81	105	48	8
220	224	204.2	40	64	112	140	62	12

Size	D3	D4	H1	H2	H3	H7	L3	L4
125	15	M5	64	22.5	50.4	36	21	8
160	18	M5	76.5	27	62	46	23	12.5
220	28	M6	111.5	42.5	91	54	33	17.5

Size	L5	L6	L7	L8	L9	T1	T2
125	14	1.8	16	2	-	2.5	12
160	18	2	17	0.55	14.9	2.5	12
220	25.5	2	30	2	18	3	15

Size	Stroke	L1	L2 min.
125	≤900	268	136.5
160	<1377	296	151.3
	≥1377	336	171
220	<1604	409	206
	≥1604	469	236

## Data sheet

### Dimensions

Download CAD data → [www.festo.com](http://www.festo.com)

Profile

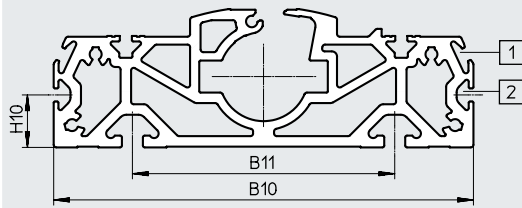

- [1] Sensor slot for proximity switch
- [2] Mounting slot for slot nut

Size	B10	B11	H10
125	122	80	20
160	160	100	20
220	220	140	20



Data sheet

GK – Standard slide  
 Size 125

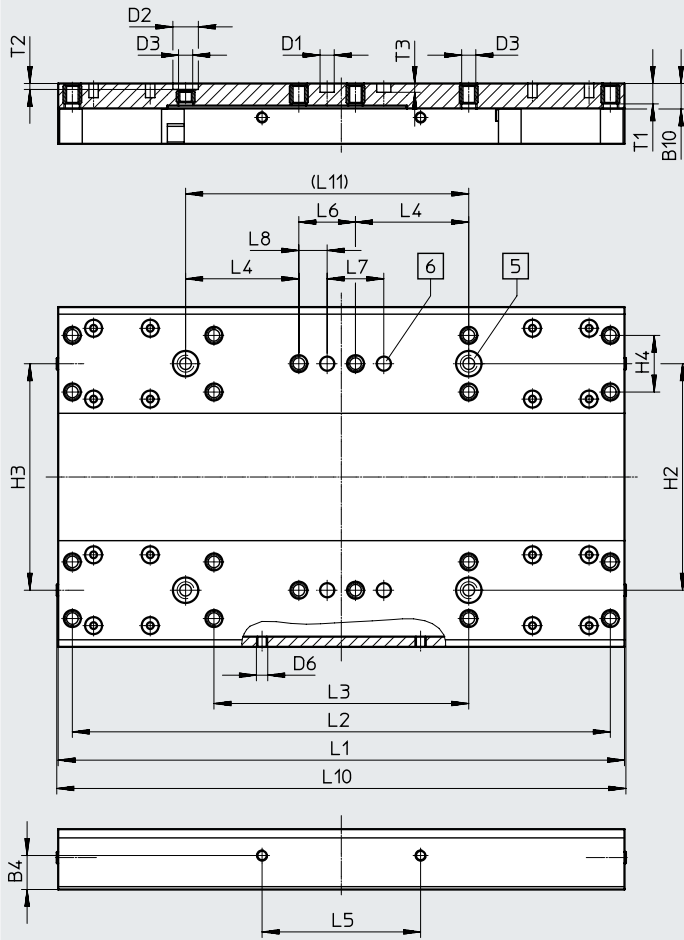

- [5] Drilled hole for centring sleeve ZBH
- [6] Drilled hole for centring pin ZBS

Size	B4	B10	D1 ∅ H7	D2 ∅ H7	D3	D6	H2	H3	H4	L1	L2	L3
125	±0.1 12	9	5	9	M5	M4	±0.03 80	±0.05 80	±0.1 20	±0.1 200	±0.2 190	±0.1 90

Size	L4	L5	L6	L7	L8	L10	L11	T1	T2	T3
125	±0.1 40	±0.2 56	±0.1 20	±0.03 20	±0.1 10	202	±0.03 100	7.8	+0.1 2.1	+0.1 3.1

Data sheet

Dimensions

Download CAD data → [www.festo.com](http://www.festo.com)

GK – Standard slide / GP – Standard slide, protected

Size 160

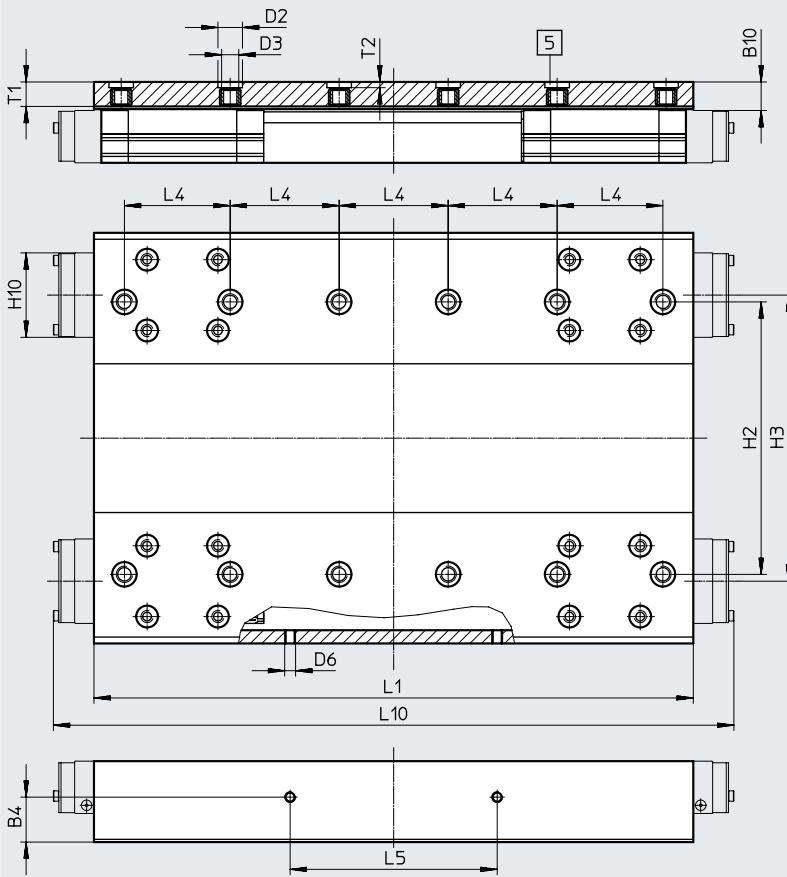

[5] Drilled hole for centring sleeve ZBH

Size	B4	B10*	D2 ∅ H7	D3	D6	H2 ±0.03	H3 ±0.05
160	16.5	10.5	9	M6	M4	100	105
Size	H10*	L1	L4	L5	L10*	T1	T2
160	31	±0.1 220	±0.03 40	±0.1 76	250	9	+0.1 2.1

\* Protected version

Data sheet

Dimensions

Download CAD data → [www.festo.com](http://www.festo.com)

GK – Standard slide / GP – Standard slide, protected

Size 220

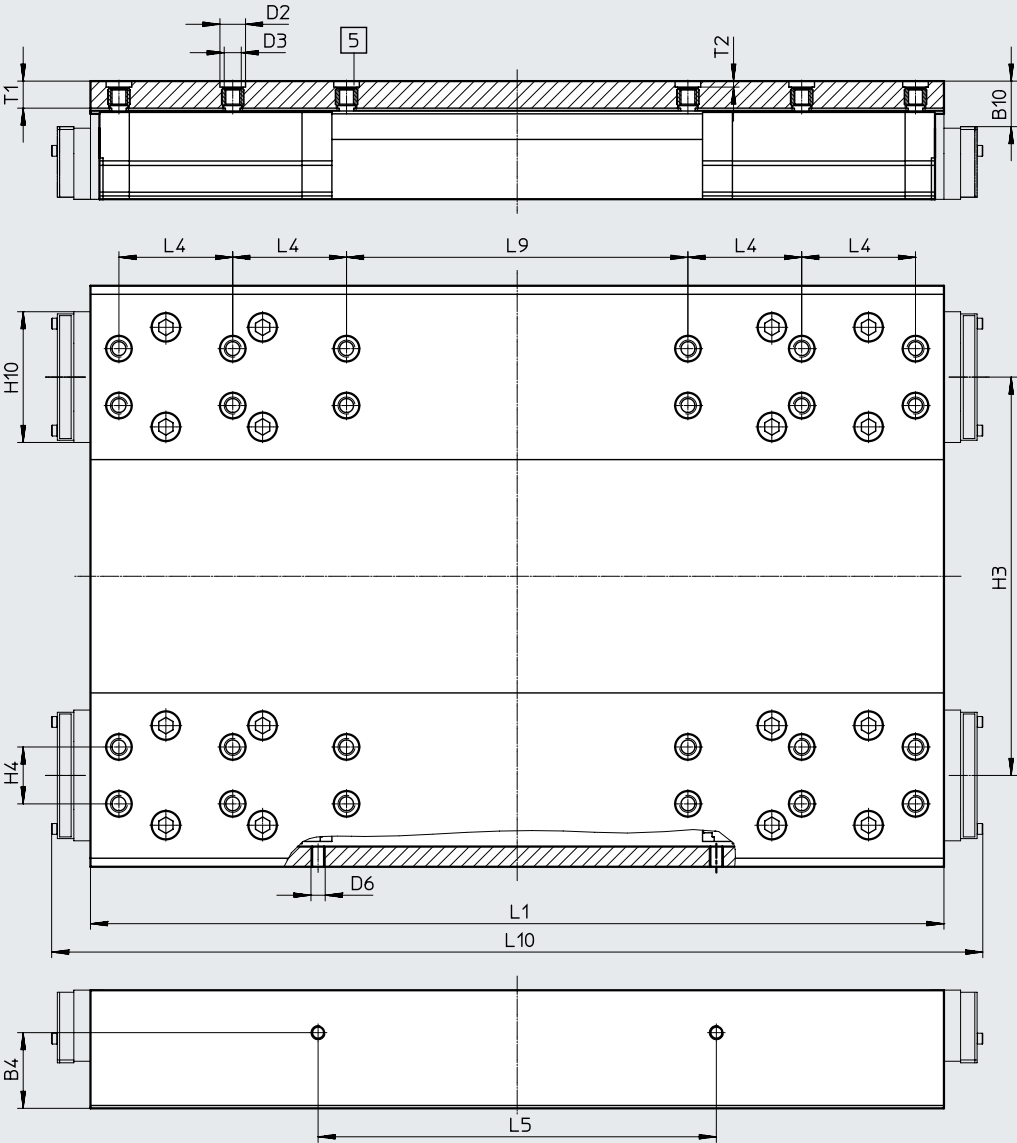

[5] Drilled hole for centring sleeve ZBH

Size	B4	B10*	D2 ∅ H7	D3	D6	H3	H4	H10*
220	±0.1 26.6	16	9	M6	M5	±0.05 140	±0.03 20	45.95

Size	L1	L4	L5	L9	L10*	T1	T2
220	±0.1 302	±0.03 40	±0.1 140	±0.03 120	328	9.5	+0.1 2.1

\* Protected version

Data sheet

Dimensions

Download CAD data → [www.festo.com](http://www.festo.com)

GK-C – Standard slide with lubrication adapter

Size 125

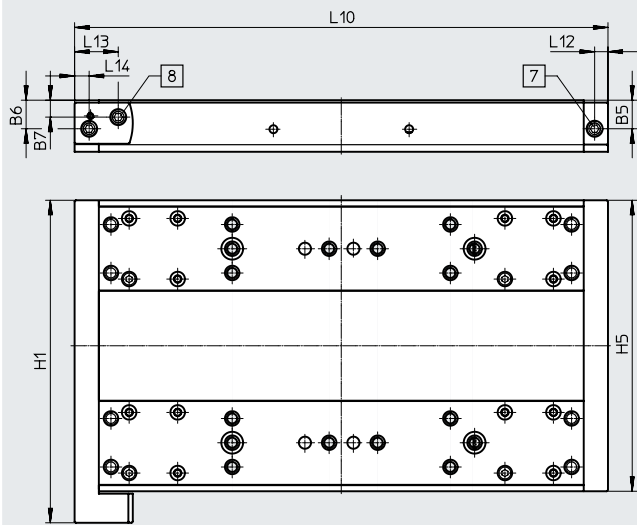

Size 160

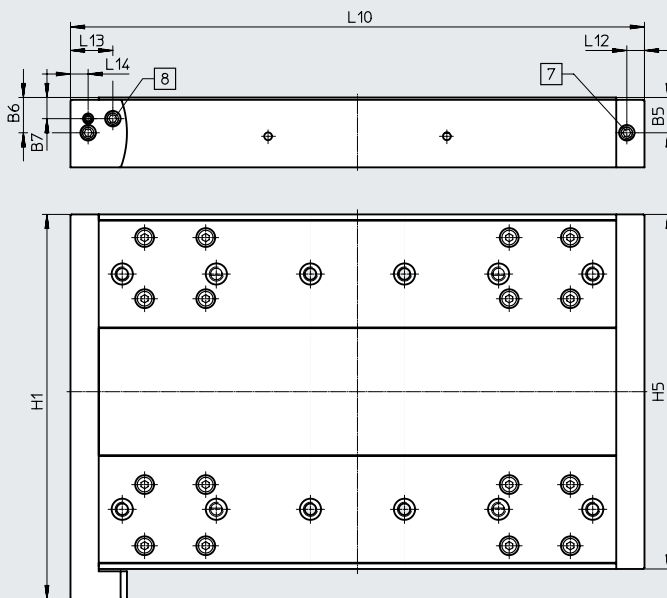

Size 220

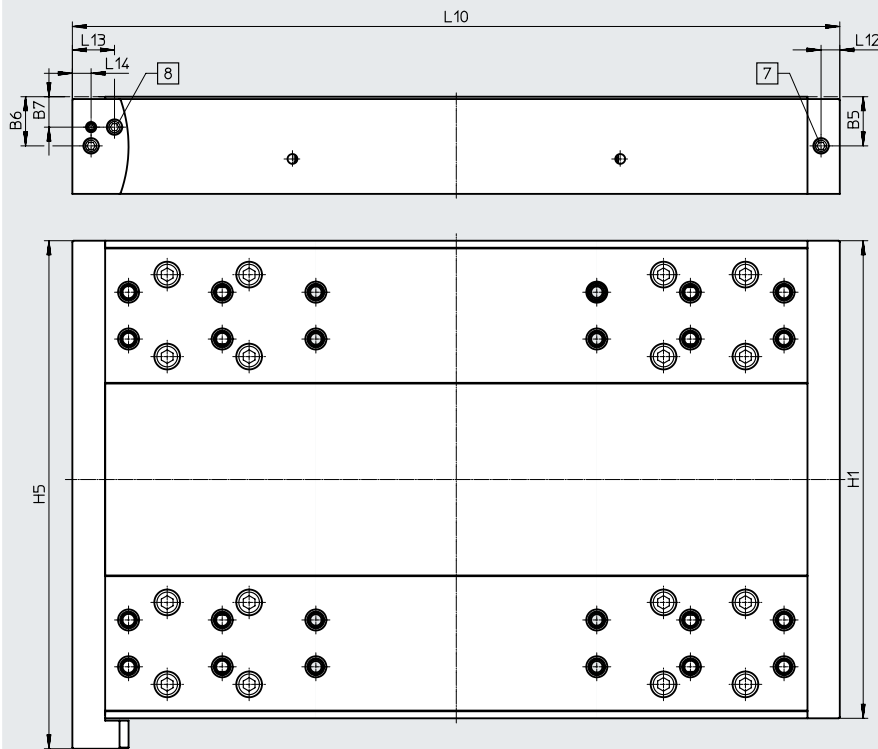

[7] Lubricating hole for lubrication adapter M6 threaded connection, 7 mm deep

[8] Lubricating hole for spindle M6 threaded connection, 7 mm deep

Size	B5	B6	B7	H1	H5	L10	L12	L13	L14
125	11.8	11.8	7	120	133	220	5.5	18	6
160	15	15	9	150.7	163.7	244	7.5	18	7.5
220	21	21	13	204	217	327.6	8	18	8

Data sheet

**Dimensions**

Download CAD data → [www.festo.com](http://www.festo.com)

M1/M2 – With incremental displacement encoder

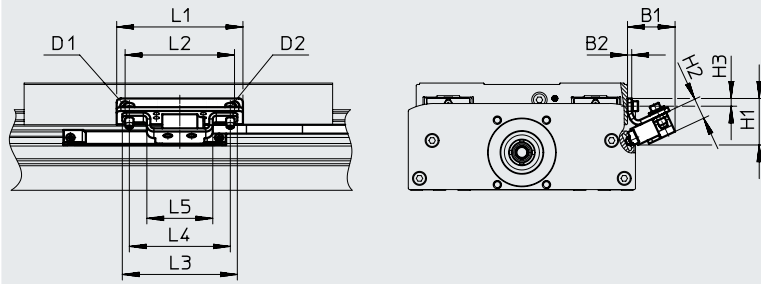

Encoder cable  
(Connection to motor controller/  
safety system) → page 45

Size	B1	B2	D1	D2	H1	H2
125	30.4	3	M4x8	M4x14	28.3	15
160	33.9	3	M4x8	M4x14	33.2	15
220	35.7	3	M5x10	M4x14	40.9	15

Size	H3	L1	L2	L3	L4	L5
125	5	108.5	56	82	72	47
160	5.5	90	76	82	72	47
220	7.5	170	140	82	72	47

Ordering data – Modular product system

Orientation guide

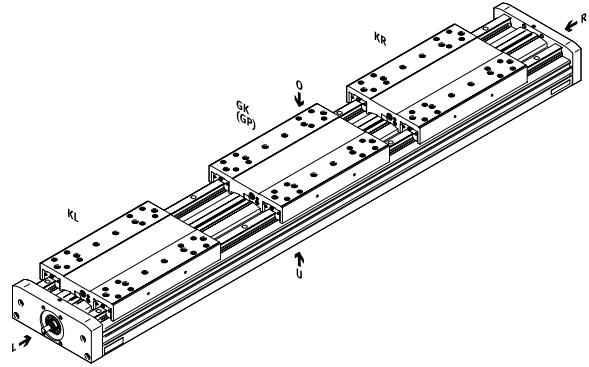
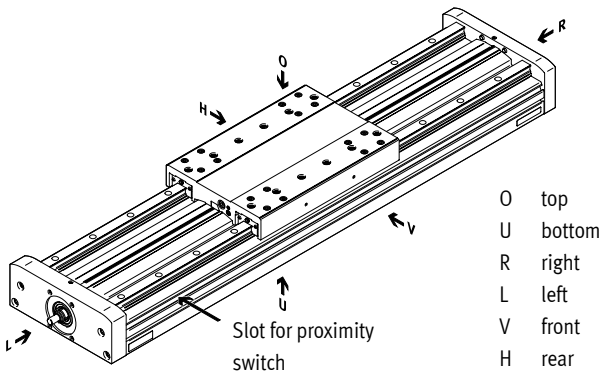

Accessories

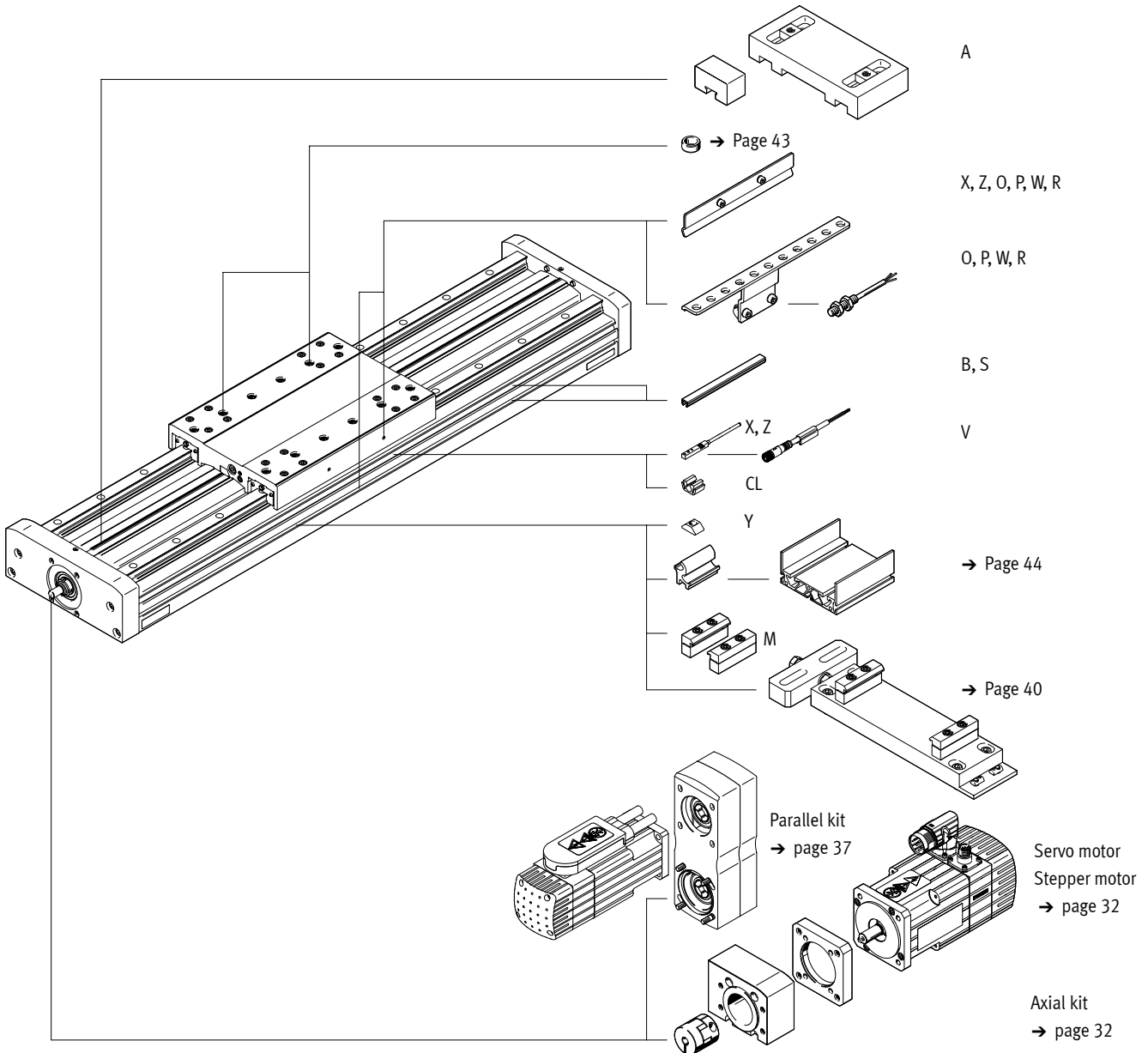

## Ordering data – Modular product system

Ordering table		125	160	220	Conditions	Code	Enter code
Size		125	160	220			
Module no.		<b>556819</b>	<b>556820</b>	<b>556821</b>			
Design		Linear axis				<b>EGC</b>	EGC
Guide		Heavy-duty guide				<b>-HD</b>	-HD
Size		125	160	220		-...	-...
Stroke length (without stroke reserve)	Standard [mm]	100, 200, 300, 400, 500, 600, 700, 900	100, 200, 300, 400, 500, 600, 700, 800, 900, 1300, 1400, 1700, 1900	100, 200, 300, 400, 500, 600, 700, 800, 900, 1300, 1400, 1900, 2400	[1]	-...	-...
	Variable [mm]	50 ... 880	50 ... 1880	50 ... 2380			
Function		Ball screw				<b>-BS</b>	-BS
Spindle pitch		10	10	10		<b>-10P</b>	
		-	20	-		<b>-20P</b>	
		-	-	25		<b>-25P</b>	
Spindle support		Without					
		With spindle support			[4]	<b>-S</b>	
		> 605 mm	> 680 mm	> 783 mm			
Stroke reserve [mm]	0 ... 999 (0 = no stroke reserve)			[1]	<b>-...H</b>		
Slide		Standard slide				<b>-GK</b>	
		-	Standard slide, protected			<b>-GP</b>	
Additional slide	Left	Additional slide, standard, left			[2]	<b>-KL</b>	
	Right	Additional slide, standard, right			[2]	<b>-KR</b>	
Lubrication function		Without					
		Lubrication adapter			[6]	<b>-C</b>	
Measurement system		Without					
		With displacement encoder, incremental, 2.5 µm				<b>-M1</b>	
		With displacement encoder, incremental, 10 µm				<b>-M2</b>	
Displacement encoder attachment position		Without					
		Rear			[7]	<b>-B</b>	
		Front			[7]	<b>-F</b>	
Accessories	Accessories enclosed separately				<b>ZUB-</b>	ZUB-	
Profile mounting	1 ... 50				<b>...M</b>		
Slot cover	Mounting slot	1 ... 50 (1 = 2 units, 500 mm length)			[5]	<b>...B</b>	
	Sensor slot	1 ... 50 (1 = 2 units, 500 mm length)				<b>...S</b>	
Slot nut for mounting slot	1 ... 99			[5]	<b>...Y</b>		
Proximity switch (SIES), inductive, slot type 8, PNP, including switch lug	N/O contact, 7.5 m cable	1 ... 6				<b>...X</b>	
	N/C contact, 7.5 m cable	1 ... 6				<b>...Z</b>	
Emergency buffer with retaining bracket	1 ... 2			[3]	<b>...A</b>		
Proximity sensor (SIEN), inductive, M8, PNP, including switch lug with sensor bracket	N/O contact, 2.5 m cable	1 ... 99				<b>...O</b>	
	N/C contact, 2.5 m cable	1 ... 99				<b>...P</b>	
	N/O contact, M8 plug	1 ... 99				<b>...W</b>	
	N/C contact, M8 plug	1 ... 99				<b>...R</b>	
Connecting cable, M8, 3-wire, 2.5 m	1 ... 99				<b>...V</b>		
Cable clip	10, 20, 30, 40, 50, 60, 70, 80, 90				<b>...CL</b>		
Operating instructions	Express waiver - no user documentation to be included (already available) (operating instructions in PDF format are available free of charge on the Internet at <a href="http://www.festo.com">http://www.festo.com</a> )				<b>-DN</b>		

[1] -... The sum of nominal stroke and 2x stroke reserve must not exceed the maximum stroke length.

[2] KL, KR If the protected slide variant (GP) is selected, the additional slide (KL, KR) is also protected.  
If the slide with lubrication adapter (GK-C) is selected, then the additional slide (KL, KR) is also supplied with lubrication adapter

[3] ... A Cannot be combined with slide GP.

[4] S Only available at or above the specified strokes.

[5] B, Y Included in the scope of delivery with size 160 for both slot sizes (→ page 43).

[6] C Cannot be combined with GP, O, P, W, R, V

[7] B, F Mandatory in combination with (measurement system) M1, M2  
Only in combination with (measurement system) M1, M2

## Accessories

 **Note**

Depending on the combination of motor and drive, it may not be possible to reach the maximum feed force of the drive.

When using parallel kits, the no-load driving torque of the particular kit must be taken into consideration.

**Permissible axis/motor combinations with axial kit**

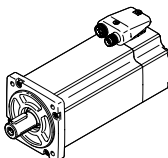
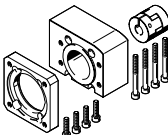
Motor/gear unit <sup>1)</sup>	Axial kit	
		<ul style="list-style-type: none"> <li>Kits for third-party motors → Internet: eamm-a</li> </ul>
Type	Part no.	Type
<b>EGC-HD-125</b>		
<b>With servo motor</b>		
EMME-AS-40-...	3637972	EAMM-A-S38-40P-G2
EMMT-AS-60-..., EMME-AS-60-...	3637958	EAMM-A-S38-60P-G2
<b>With servo motor and gear unit</b>		
EMME-AS-40-... EMGA-40-P-G...-EAS-40	1456647	EAMM-A-S38-40G-G2
<b>With stepper motor</b>		
EMMS-ST-42-...	3637965	EAMM-A-S38-42A-G2
EMMS-ST-57-...	3637956	EAMM-A-S38-57A-G2
<b>With stepper motor and gear unit</b>		
EMMS-ST-42-... EMGA-40-P-G...-SST-42	1456647	EAMM-A-S38-40G-G2
<b>With integrated drive</b>		
EMCA-EC-67-...	1456638	EAMM-A-S38-67A-G2
<b>With integrated drive and gear unit</b>		
EMCA-EC-67-... EMGC-40-...	1456647	EAMM-A-S38-40G-G2

1) The input torque must not exceed the max. permissible transferable torque of the axial kit.

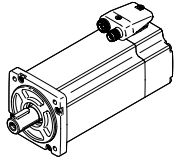
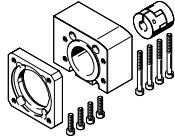

## Accessories

Permissible axis/motor combinations with axial kit		
Motor/gear unit <sup>1)</sup>	Axial kit	
		<ul style="list-style-type: none"> <li>Kits for third-party motors → Internet: eamm-a</li> </ul>
Type	Part no.	Type
<b>EGC-HD-160</b>		
<b>With servo motor</b>		
EMMT-AS-60-..., EMME-AS-60-...	3637964	EAMM-A-S48-60P-G2
<b>With servo motor and gear unit</b>		
EMME-AS-40-...	1456650	EAMM-A-S48-40G-G2
EMGA-40-P-G...-EAS-40		
EMMT-AS-60-..., EMME-AS-60-...	1456652	EAMM-A-S48-60H-G2
EMGA-60-P-G...-EAS-60		
<b>With stepper motor</b>		
EMMS-ST-57-...	3637963	EAMM-A-S48-57A-G2
EMMS-ST-87-...	3637962	EAMM-A-S48-87A-G2
<b>With stepper motor and gear unit</b>		
EMMS-ST-42-...	1456650	EAMM-A-S48-40G-G2
EMGA-40-P-G...-SST-42		
EMMS-ST-57-...	2256701	EAMM-A-S48-60G-G2
EMGA-60-P-G...-SST-57		
<b>With integrated drive and gear unit</b>		
EMCA-EC-67-...	1456650	EAMM-A-S48-40G-G2
EMGC-40-...		
EMCA-EC-67-...	1456652	EAMM-A-S48-60H-G2
EMGC-60-...		

1) The input torque must not exceed the max. permissible transferable torque of the axial kit.

## Accessories

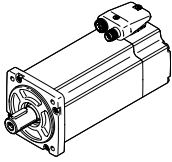
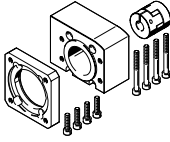

Permissible axis/motor combinations with axial kit		
Motor/gear unit <sup>1)</sup>	Axial kit	
		<ul style="list-style-type: none"> <li>Kits for third-party motors → Internet: eamm-a</li> </ul>
Type	Part no.	Type
<b>EGC-HD-220</b>		
<b>With servo motor</b>		
EMMT-AS-80-..., EMME-AS-80-...	3637970	EAMM-A-S62-80P-G2
EMMT-AS-100-..., EMME-AS-100-...	3637960	EAMM-A-S62-100A-G2
EMMS-AS-140-...	3637969	EAMM-A-S62-140A-G2
<b>With servo motor and gear unit</b>		
EMMT-AS-60-..., EMME-AS-60-... EMGA-60-P-G...-EAS-60	1456654	EAMM-A-S62-60H-G2
EMMT-AS-80-..., EMME-AS-80-... EMGA-80-P-G...-EAS-80	1972530	EAMM-A-S62-80G-G2
EMMT-AS-100-..., EMME-AS-100-... EMGA-80-P-G...-SAS-100	1972530	EAMM-A-S62-80G-G2
<b>With stepper motor</b>		
EMMS-ST-87-...	3637966	EAMM-A-S62-87A-G2
<b>With stepper motor and gear unit</b>		
EMMS-ST-57-... EMGA-60-P-G...-SST-57	2297649	EAMM-A-S62-60G-G2
EMMS-ST-87-... EMGA-80-P-G...-SST-87	1972530	EAMM-A-S62-80G-G2
<b>With integrated drive and gear unit</b>		
EMCA-EC-67-... EMGC-60-...	1456654	EAMM-A-S62-60H-G2
EMCA-EC-67-... EMGC-80-...	1972530	EAMM-A-S62-80G-G2

1) The input torque must not exceed the max. permissible transferable torque of the axial kit.

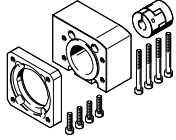
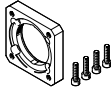
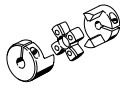
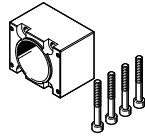
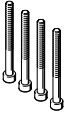
## Accessories

Individual components of the axial kit				
Axial kit	Comprising:			
	Motor flange	Coupling	Coupling housing	Screw set
				
Part no. Type	Part no. Type	Part no. Type	Part no. Type	Part no. Type
<b>EGC-HD-125</b>				
3637971 EAMM-A-S38-40A-G2	558175 EAMF-A-38B-40A	558312 EAMC-30-32-6-6	3637942 EAMK-A-S38-38A/B-G2	–
1456647 EAMM-A-S38-40G-G2	1460097 EAMF-A-38A-40G	562681 EAMC-30-32-6-10	3637942 EAMK-A-S38-38A/B-G2	567488 EAHM-L2-M5-50
3637972 EAMM-A-S38-40P-G2	2219077 EAMF-A-38B-40P	533708 EAMC-30-32-6-8	3637942 EAMK-A-S38-38A/B-G2	–
3637965 EAMM-A-S38-42A-G2	560691 EAMF-A-38B-42A	561333 EAMC-30-32-5-6	3637942 EAMK-A-S38-38A/B-G2	–
3637967 EAMM-A-S38-55A-G2	558176 EAMF-A-38A-55A	551003 EAMC-30-32-6-9	3637942 EAMK-A-S38-38A/B-G2	567488 EAHM-L2-M5-50
3637956 EAMM-A-S38-57A-G2	560692 EAMF-A-38A-57A	551002 EAMC-30-32-6-6.35	3637942 EAMK-A-S38-38A/B-G2	567488 EAHM-L2-M5-50
3637958 EAMM-A-S38-60P-G2	1987412 EAMF-A-38A-60P	1233256 EAMC-30-32-6-14	3637942 EAMK-A-S38-38A/B-G2	567489 EAHM-L2-M5-55
1456638 EAMM-A-S38-67A-G2	1490100 EAMF-A-38A-67A	551003 EAMC-30-32-6-9	3637942 EAMK-A-S38-38A/B-G2	567489 EAHM-L2-M5-55
<b>EGC-HD-160</b>				
1456650 EAMM-A-S48-40G-G2	4067069 EAMF-A-48B-40G	558029 EAMC-30-32-8-10	3637941 EAMK-A-S48-48A/B-G2	–
3637961 EAMM-A-S48-55A-G2	558177 EAMF-A-48B-55A	543423 EAMC-30-32-8-9	3637941 EAMK-A-S48-48A/B-G2	–
3637963 EAMM-A-S48-57A-G2	560694 EAMF-A-48B-57A	543421 EAMC-30-32-6.35-8	3637941 EAMK-A-S48-48A/B-G2	–
2256701 EAMM-A-S48-60G-G2	558019 EAMF-A-48A-60G/H	551004 EAMC-30-32-8-11	3637941 EAMK-A-S48-48A/B-G2	567489 EAHM-L2-M5-55
1456652 EAMM-A-S48-60H-G2	558019 EAMF-A-48A-60G/H	562682 EAMC-30-32-8-14	3637941 EAMK-A-S48-48A/B-G2	567489 EAHM-L2-M5-55
3637964 EAMM-A-S48-60P-G2	2220620 EAMF-A-48A-60P	562682 EAMC-30-32-8-14	3637941 EAMK-A-S48-48A/B-G2	567489 EAHM-L2-M5-55
3637957 EAMM-A-S48-70A-G2	558025 EAMF-A-48A-70A	551004 EAMC-30-32-8-11	3637941 EAMK-A-S48-48A/B-G2	567488 EAHM-L2-M5-50
3637962 EAMM-A-S48-87A-G2	560695 EAMF-A-48A-87A	551004 EAMC-30-32-8-11	3637941 EAMK-A-S48-48A/B-G2	567489 EAHM-L2-M5-55

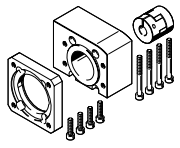
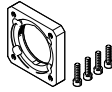
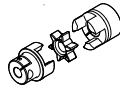
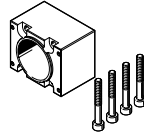
## Accessories

Individual components of the axial kit				
Axial kit	Comprising:			
	Motor flange	Coupling	Coupling housing	Screw set
				
Part no. Type	Part no. Type	Part no. Type	Part no. Type	Part no. Type
<b>EGC-HD-220</b>				
2297649 EAMM-A-S62-60G-G2	1460112 EAMF-A-62A-60G/H	525864 EAMC-40-66-11-12	3637940 EAMK-A-S62-62A/B-G2	567495 EAHM-L2-M6-90
1456654 EAMM-A-S62-60H-G2	1460112 EAMF-A-62A-60G/H	1452803 EAMC-40-66-12-14	3637940 EAMK-A-S62-62A/B-G2	567495 EAHM-L2-M6-90
3637959 EAMM-A-S62-70A-G2	558179 EAMF-A-62B-70A	558313 EAMC-42-66-11-12	3637940 EAMK-A-S62-62A/B-G2	–
1972530 EAMM-A-S62-80G-G2	2116672 EAMF-A-62B-80G	2138701 EAMC-42-50-12-20	3637940 EAMK-A-S62-62A/B-G2	–
3637970 EAMM-A-S62-80P-G2	2222624 EAMF-A-62B-80P	551005 EAMC-42-50-12-19	3637940 EAMK-A-S62-62A/B-G2	–
3637966 EAMM-A-S62-87A-G2	560696 EAMF-A-62B-87A	558313 EAMC-42-66-11-12	3637940 EAMK-A-S62-62A/B-G2	–
3637960 EAMM-A-S62-100A-G2	558026 EAMF-A-62A-100A	551005 EAMC-42-50-12-19	3637940 EAMK-A-S62-62A/B-G2	567494 EAHM-L2-M6-80
3637969 EAMM-A-S62-140A-G2	558022 EAMF-A-62A-140A	558314 EAMC-42-50-12-24	3637940 EAMK-A-S62-62A/B-G2	567495 EAHM-L2-M6-90

## Accessories

Data sheets → Internet: eamm-u

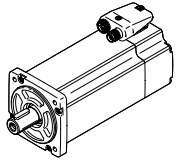
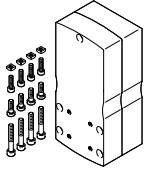
Permissible axis/motor combinations with parallel kit		
Motor/gear unit <sup>1)</sup>	Parallel kit	
		<ul style="list-style-type: none"> <li>To support the axis shaft, a counter bearing EAMG and a clamping sleeve EAMH-...-P with integrated trunnion are included in the scope of delivery for the parallel kit. Additional information → eamm-u</li> <li>Kits for third-party motors → Internet: eamm-u</li> </ul>
Type	Part no.	Type
<b>EGC-HD-125</b>		
<b>With servo motor</b>		
EMME-AS-40-...	2155239	EAMM-U-50-S38-40P-78
<b>With stepper motor</b>		
EMMS-ST-42-...	1217945	EAMM-U-50-S38-42A-78
EMMS-ST-57-...	1218568	EAMM-U-60-S38-57A-91
<b>Servo motor with gear unit</b>		
EMME-AS-40-... EMGA-40-P-...	2283732	EAMM-U-60-S38-40G-91
<b>Stepper motor with gear unit</b>		
EMMS-ST-42-... EMGA-40-P-...	2283732	EAMM-U-60-S38-40G-91
<b>With integrated drive and gear unit</b>		
EMCA-EC-67-... EMGC-40-P-...	2283732	EAMM-U-60-S38-40G-91
<b>EGC-HD-160</b>		
<b>With servo motor</b>		
EMMT-AS-60-..., EMME-AS-60-...	2629253	EAMM-U-70-S48-60P-96
<b>With stepper motor</b>		
EMMS-ST-57-...	1219379	EAMM-U-60-S48-57A-91
EMMS-ST-87-...	1217604	EAMM-U-86-S48-87A-177
<b>With servo motor and gear unit</b>		
EMME-AS-40-... EMGA-40-P-...	2283760	EAMM-U-60-S48-40G-91
EMMT-AS-60-..., EMME-AS-60-... EMGA-60-P-...-EAS <sup>2)</sup>	2801715	EAMM-U-70-S48-60H-96
	1587338	EAMM-U-86-S48-60H-102
<b>With stepper motor and gear unit</b>		
EMMS-ST-42-... EMGA-40-P-...	2283760	EAMM-U-60-S48-40G-91
EMMS-ST-57-... EMGA-60-P-...-SST <sup>2)</sup>	2801627	EAMM-U-70-S48-60G-96
	1587251	EAMM-U-86-S48-60G-102
<b>With integrated drive and gear unit</b>		
EMCA-EC-67-... EMGC-40-P-...	2283760	EAMM-U-60-S48-40G-91
EMCA-EC-67-... EMGC-60-P-... <sup>2)</sup>	2801715	EAMM-U-70-S48-60H-96
	1587338	EAMM-U-86-S48-60H-102

1) The input torque must not exceed the max. permissible transferable torque of the parallel kit.

2) Gear unit output shaft diameter: EMGA-60-P-...-SAS/SST: 11 mm; EMGA-60-P-...-EAS, EMGC-60-P: 14 mm

## Accessories

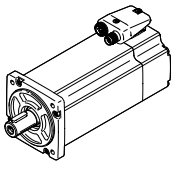
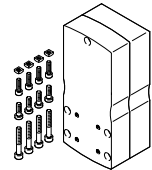
Permissible axis/motor combinations with parallel kit		Data sheets → Internet: eamm-u	
Motor/gear unit <sup>1)</sup>	Parallel kit		
			<ul style="list-style-type: none"> <li>To support the axis shaft, a counter bearing EAMG and a clamping sleeve EAMH-...-P with integrated trunnion are included in the scope of delivery for the parallel kit. Additional information → eamm-u</li> <li>Kits for third-party motors → Internet: eamm-u</li> </ul>
Type	Part no.	Type	
<b>EGC-HD-220</b>			
<b>With servo motor</b>			
EMMT-AS-80-..., EMME-AS-80-...	2157004	EAMM-U-86-S62-80P-177	
EMMT-AS-100-..., EMME-AS-100-...	1217381	EAMM-U-110-S62-100A-207	
EMMS-AS-140-...	1219440	EAMM-U-145-S62-140A-288	
<b>With stepper motor</b>			
EMMS-ST-87-...	1217373	EAMM-U-86-S62-87A-177	
<b>With servo motor and gear unit</b>			
EMMT-AS-60-..., EMME-AS-60-... EMGA-60-P-...-EAS <sup>2)</sup>	1587453	EAMM-U-86-S62-60H-177	
<b>With stepper motor and gear unit</b>			
EMMS-ST-57-... EMGA-60-P-...-SST <sup>2)</sup>	1587411	EAMM-U-86-S62-60G-177	
<b>With integrated drive and gear unit</b>			
EMCA-EC-67-... EMGC-60-P-..... <sup>2)</sup>	1587453	EAMM-U-86-S62-60H-177	

1) The input torque must not exceed the max. permissible transferable torque of the parallel kit.

2) Gear unit output shaft diameter: EMGA-60-P-...SAS/SST: 11 mm; EMGA-60-P-...EAS, EMGC-60-P: 14 mm

 **Note**

The clamping element EADT is required to adjust the toothed belt pretension with EAMM-U-110 and EAMM-U-145.

## Accessories

**Profile mounting MUE**  
(order code M)

Material:  
Anodised aluminium  
RoHS-compliant

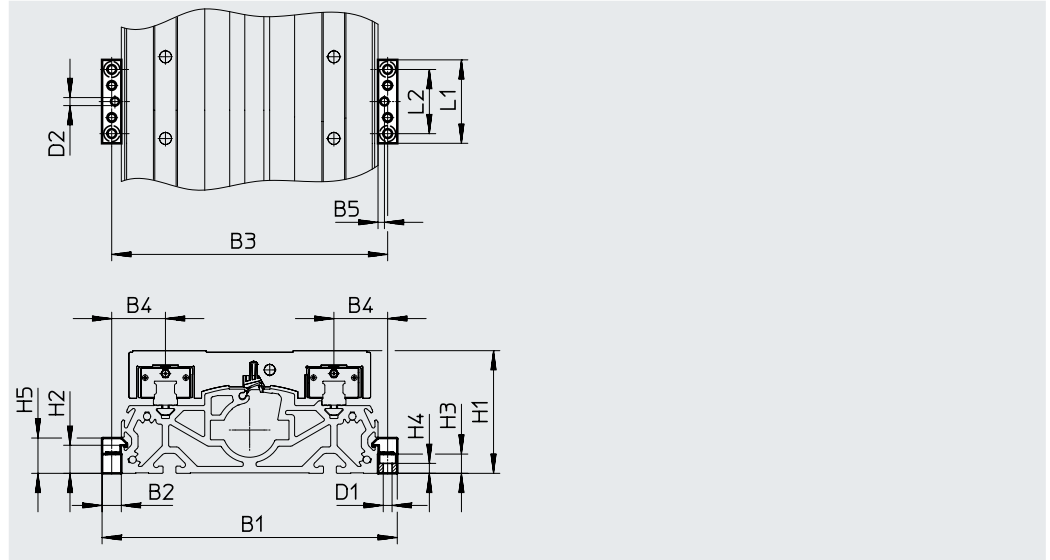
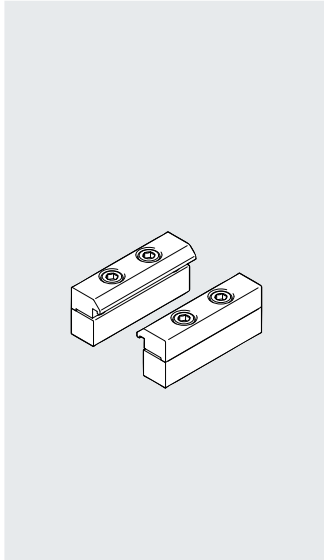

### Dimensions and ordering data

For size	B1	B2	B3	B4	B5	D1 ∅	D2 ∅ H7	H1	H2
125	146	12	134	27	4	5.5	5	64	17.5
160	184	12	172	33.5	4	5.5	5	76.5	17.5
220	258	19	239	49.5	4	9	5	111.5	16

For size	H3	H4	H5	L1	L2	Weight [g]	Part no.	Type
125	12	6.2	22	52	40	80	558043	MUE-70/80
160	12	6.2	22	52	40	80	558043	MUE-70/80
220	14	5.5	29.5	90	40	290	558044	MUE-120/185

## Accessories

### Adjusting kit EADC-E16

Material:  
Wrought aluminium alloy  
RoHS-compliant

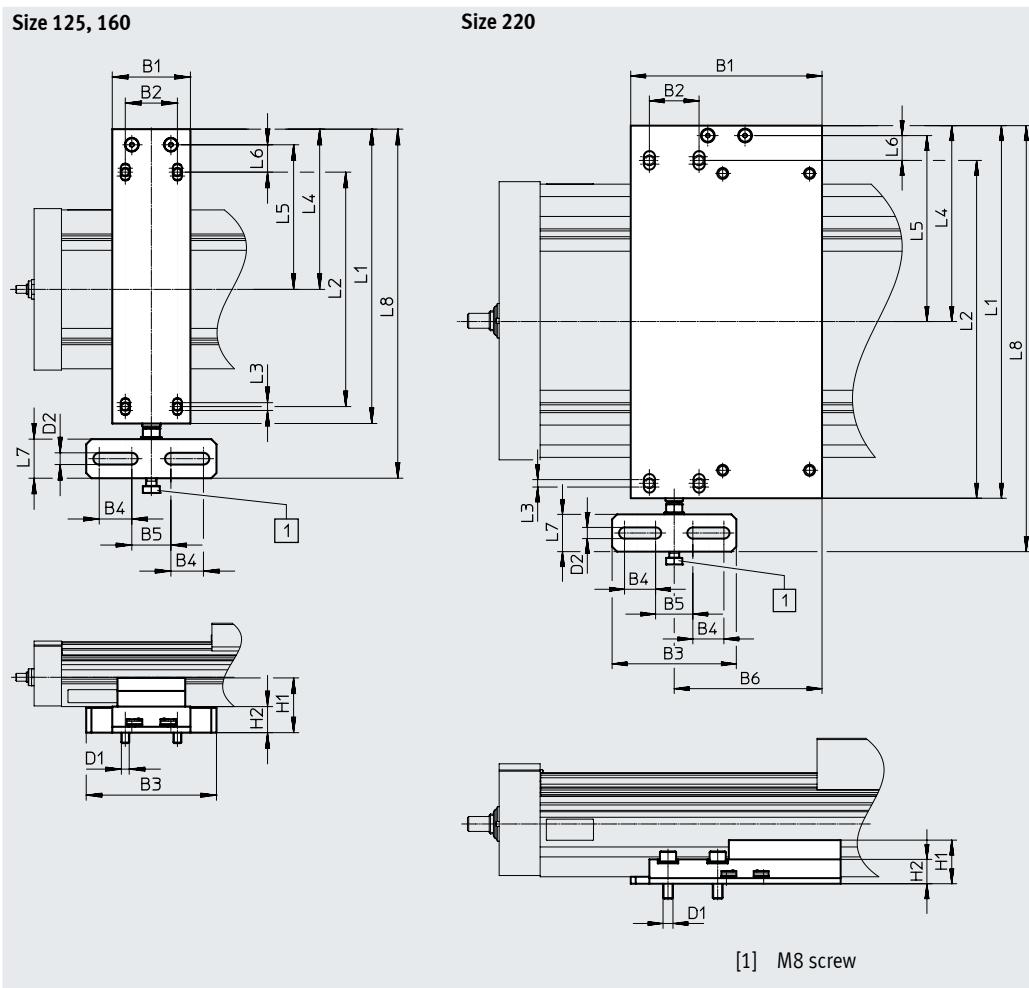
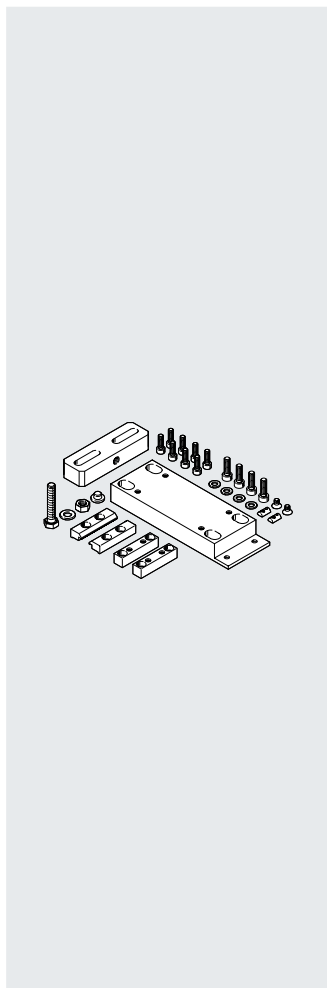

#### Dimensions and ordering data

For size	B1	B2	B3	B4	B5	B6	D1	D2	H1	H2	L1	L2
125	60	40	100	25	30	–	M6	9	42	20	226	180
160	60	40	100	25	30	–	M6	9	44	22	266	220
220	154	40	100	25	30	119	M8	9	35.1	19.6	300	260

For size	L3	L4	L5	L6	L7	L8	Weight [g]	Part no.	Type
125	6	123	111	21	30	308	974	8047580	EADC-E16-125-E14
160	6	143	131	21	30	343	1189	8047581	EADC-E16-160-E14
220	6	157.7	149.7	20	30	343	1500	8047582	EADC-E16-220-E14



## Accessories

### Retaining bracket EAYH

Emergency buffer NPE → page 43  
(order code A)

Material:  
Anodised aluminium  
RoHS-compliant

Cannot be used in combination with  
the variants GP or C.

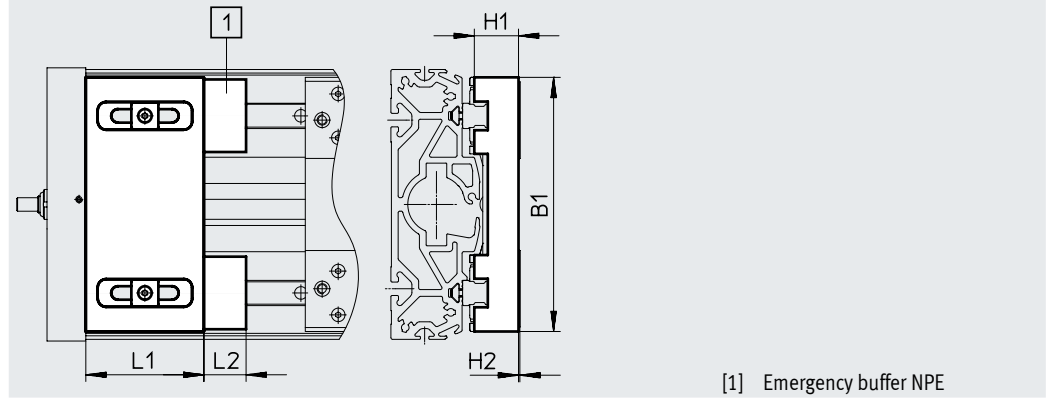
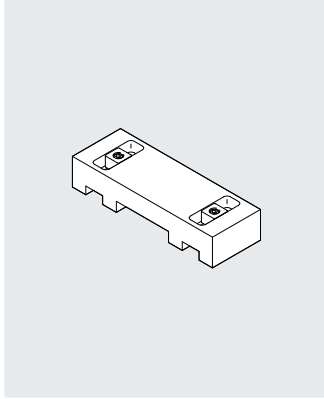

Dimensions and ordering data								
For size	B1	H1	H2	L1	L2	Weight [g]	Part no.	Type
125	120	19.8	0.4	50	17	260	1662803	EAYH-L2-125-N
160	150.7	26.2	0.8	70	25	617	1669259	EAYH-L2-160-N
220	204	38.7	0.1	70	30	1195	1669260	EAYH-L2-220-N

### Switch lug SF-EGC-HD-1

For sensing via proximity switch  
SIES-8M  
(order code X or Z)

Material:  
Galvanised steel  
RoHS-compliant

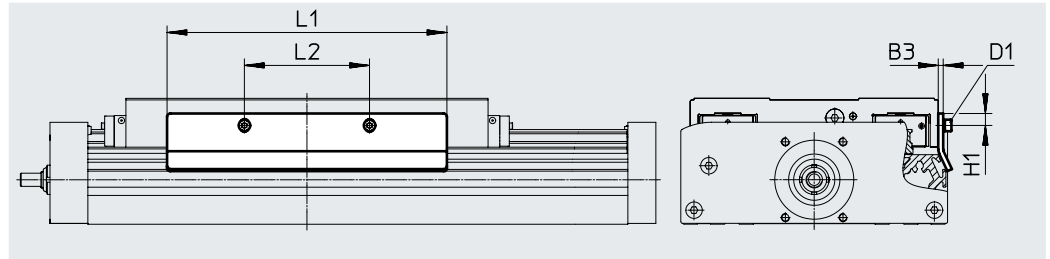
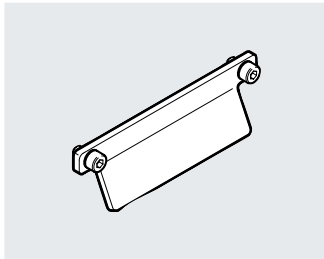

Dimensions and ordering data								
For size	B3	D1	H1	L1	L2	Weight [g]	Part no.	Type
125	2	M4x8	7.8	150	56	70	570027	SF-EGC-HD-1-125
160	3	M4x8	7.3	170	76	160	1645872	SF-EGC-HD-1-160
220	3	M5x10	11.5	250	140	310	1645866	SF-EGC-HD-1-220

## Accessories

### Switch lug SF-EGC-HD-2

For sensing via proximity switch  
SIEN-M8B (order code O, P, W or R) or  
SIES-8M (order code X or Z)

Material:  
Galvanised steel  
RoHS-compliant

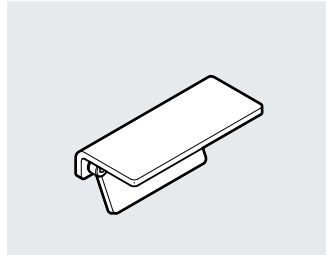

### Sensor bracket HWS-EGC

For proximity switch SIEN-M8B (order  
code O, P, W or R)

Material:  
Galvanised steel  
RoHS-compliant

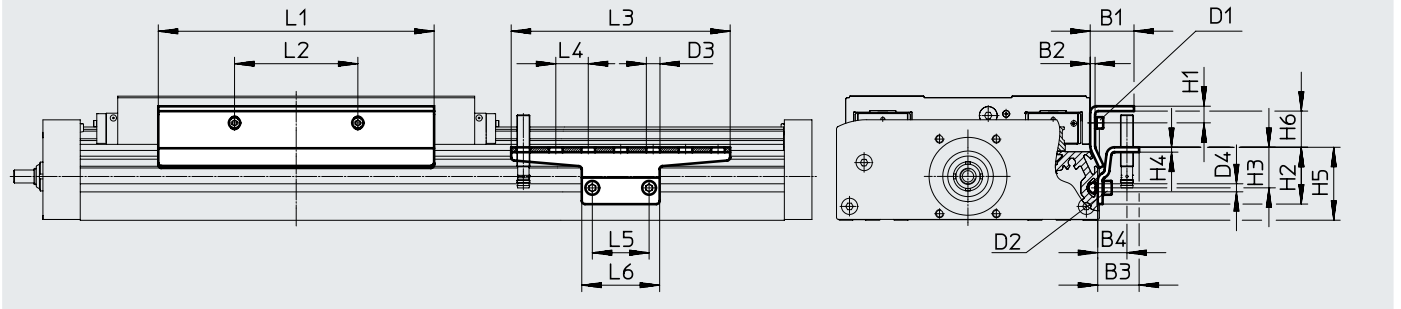
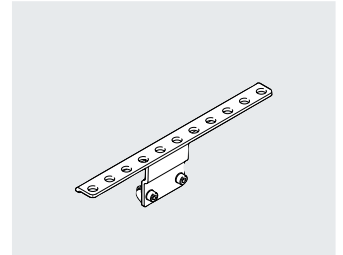

#### Dimensions and ordering data





For size	B1	B2	B3	B4	D1	D2	D3	D4	H1	H2
125	24	2	25.5	18	M4x8	M5x8	8.4	5.2	9	35
160	27	3	25.5	18	M4x8	M5x8	8.4	5.2	10.3	35
220	31	3	25.5	18	M5x10	M5x14	8.4	5.2	11.5	65

For size	H3	H4	H5	H6	L1	L2	L3	L4	L5	L6
125	25	3	45	14	150	56	135	20	35	48
160	25	3	45	22.2	170	76	135	20	35	48
220	55	3	75	18.4	250	140	215	20	35	48

For size	Weight [g]	Part no.	Type
Switch lug			
125	122	570030	SF-EGC-HD-2-125
160	261	1645865	SF-EGC-HD-2-160
220	430	1645868	SF-EGC-HD-2-220

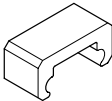
For size	Weight [g]	Part no.	Type
Sensor bracket			
125	110	558057	HWS-EGC-M5
160	110	558057	HWS-EGC-M5
220	217	570365	HWS-EGC-M8-B

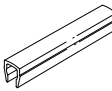
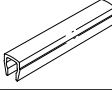
## Accessories

Ordering data		For size	Description	Order code	Part no.	Type	PJ <sup>1)</sup>
<b>Emergency buffer NPE</b>							
	125	Use in combination with retaining bracket EAYH	A	<b>1662475</b>	<b>NPE-125</b>		1
	160			<b>1672593</b>	<b>NPE-160</b>		
	220			<b>1672598</b>	<b>NPE-220</b>		
<b>Slot nut NST</b>							
	125, 160 <sup>2)</sup>	For mounting slot	Y	<b>150914</b>	<b>NST-5-M5</b>		1
				<b>8047843</b>	<b>NST-5-M5-10</b>		10
				<b>8047878</b>	<b>NST-5-M5-50</b>		50
	160 <sup>3)</sup> , 220	For mounting slot	Y	<b>150915</b>	<b>NST-8-M6</b>		1
				<b>8047868</b>	<b>NST-8-M6-10</b>		10
<b>8047869</b>	<b>NST-8-M6-50</b>	50					
<b>Centring pin/sleeve ZBS/ZBH</b>							
	125	For slide	-	<b>150928</b>	<b>ZBS-5</b>		10
	125, 160, 220			<b>8137184</b>	<b>ZBH-9-B</b>		
<b>Slot cover ABP</b>							
	125, 160 <sup>2)</sup>	For mounting slot	B	<b>151681</b>	<b>ABP-5</b>		2
	160 <sup>3)</sup> , 220	Each 0.5 m		<b>151682</b>	<b>ABP-8</b>		
<b>Slot cover ABP-S</b>							
	125, 160, 220	For sensor slot Each 0.5 m	S	<b>563360</b>	<b>ABP-5-S1</b>		2
<b>Clip SMBK</b>							
	125, 160, 220	For sensor slot, for mounting the proximity switch cables	CL	<b>534254</b>	<b>SMBK-8</b>		10

- 1) Packaging unit  
2) For mounting slot at the side  
3) For mounting slot underneath

## Accessories

### Mounting options between axis and support profile

Depending on the adapter kit, the spacing between the axis and the support profile is:  
 $x = 20 \text{ mm}$  or  $50 \text{ mm}$

The support profile must be mounted using at least 2 adapter kits. For longer strokes, an adapter kit must be used every 500 mm.

Example

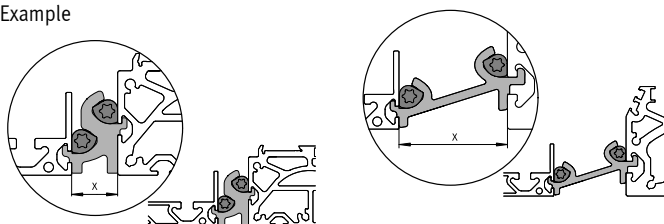

Ordering data					
	For size	Description	Part no.	Type	PU <sup>1)</sup>
<b>Adapter kit DHAM</b>					
	160	<ul style="list-style-type: none"> <li>For mounting the support profile on the axis</li> <li>Spacing between axis and profile is 20 mm</li> </ul>	562241	DHAM-ME-N1-CL	1
	220		562242	DHAM-ME-N2-CL	
	125, 160	<ul style="list-style-type: none"> <li>For mounting the support profile on the axis</li> <li>Spacing between axis and profile is 50 mm</li> </ul>	574560	DHAM-ME-N1-50-CL	
	220		574561	DHAM-ME-N2-50-CL	
<b>Support profile HMIA</b>					
	125 ... 220	<ul style="list-style-type: none"> <li>For guiding an energy chain</li> </ul>	539379	HMIA-E07-	1

1) Packaging unit

Ordering data – Proximity switches for T-slot, inductive							Data sheets → Internet: sies	
	Type of mounting	Electrical connection	Switching output	Cable length [m]	Order code	Part no.	Type	
<b>N/O contact</b>								
	Inserted in the slot from above, flush with the cylinder profile	Cable, 3-wire	PNP	7.5	X	551386	SIES-8M-PS-24V-K-7.5-OE	
		Plug M8x1, 3-pin		0.3		551387	SIES-8M-PS-24V-K-0.3-M8D	
		Cable, 3-wire	NPN	7.5	-	551396	SIES-8M-NS-24V-K-7.5-OE	
		Plug M8x1, 3-pin		0.3		551397	SIES-8M-NS-24V-K-0.3-M8D	
<b>N/C contact</b>								
	Inserted in the slot from above, flush with the cylinder profile	Cable, 3-wire	PNP	7.5	Z	551391	SIES-8M-PO-24V-K-7.5-OE	
		Plug M8x1, 3-pin		0.3		551392	SIES-8M-PO-24V-K-0.3-M8D	
		Cable, 3-wire	NPN	7.5	-	551401	SIES-8M-NO-24V-K-7.5-OE	
		Plug M8x1, 3-pin		0.3		551402	SIES-8M-NO-24V-K-0.3-M8D	

## Accessories

Ordering data – Proximity switch M8 (round design), inductive <sup>1)</sup>							Data sheets → Internet: sien
	Electrical connection	LED	Switching output	Cable length [m]	Order code	Part no.	Type
<b>N/O contact</b>							
	Cable, 3-wire	■	PNP	2.5	O	150386	SIEN-M8B-PS-K-L
			NPN	2.5	–	150384	SIEN-M8B-NS-K-L
	Plug M8x1, 3-pin	■	PNP	–	W	150387	SIEN-M8B-PS-S-L
			NPN	–	–	150385	SIEN-M8B-NS-S-L
<b>N/C contact</b>							
	Cable, 3-wire	■	PNP	2.5	P	150390	SIEN-M8B-PO-K-L
			NPN	2.5	–	150388	SIEN-M8B-NO-K-L
	Plug M8x1, 3-pin	■	PNP	–	R	150391	SIEN-M8B-PO-S-L
			NPN	–	–	150389	SIEN-M8B-NO-S-L

1) The proximity switches M8 (round design), inductive, cannot be combined with the central lubrication variant -C.

Ordering data – Connecting cables					Data sheets → Internet: nebu
	Electrical connection, left	Electrical connection, right	Cable length [m]	Part no.	Type
	Straight socket, M8x1, 3-pin	Cable, open end, 3-wire	2.5	159420	SIM-M8-3GD-2.5-PU
			2.5	541333	NEBU-M8G3-K-2.5-LE3
			5	541334	NEBU-M8G3-K-5-LE3
	Angled socket, M8x1, 3-pin	Cable, open end, 3-wire	2.5	541338	NEBU-M8W3-K-2.5-LE3
			5	541341	NEBU-M8W3-K-5-LE3

Ordering data – Encoder cables for displacement encoder system, EGC...-M1/-M2					Data sheets → Internet: nebm
	Electrical connection, left	Electrical connection, right	Cable length [m]	Part no.	Type
	Displacement encoder EGC...-M1/-M2	Motor controllers CMMP-AS and CMMT-AS	5.0	1599105	NEBM-M12G8-E-5-S1G9-V3
			10	1599106	NEBM-M12G8-E-10-S1G9-V3
			15	1599107	NEBM-M12G8-E-15-S1G9-V3
			X <sup>1)</sup>	1599108	NEBM-M12G8-E-....-S1G9-V3

1) Max. cable length 25 m.

Ordering data – Adapter			
	Description	Part no.	Type
	Required in combination with the servo drive CMMT-AS as adapter between encoder cable NEBM-M12G8-...-V3 and interface X3 (position encoder 2)	8106112	NEFM-S1G9-K-0.5-R3G8