

Manually Actuated Lever/Push-Button Valves

5/3 - 5 Ported, 4 Way, 3 Position Valves, Piloted, G 1/4 ISO

FESTO

Hand Lever Valve

Spring Centered

Type H-5/3-1/4

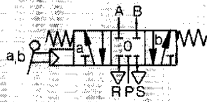

Double Push-Button Valve

Spring Centered

Type T-5/3-1/4

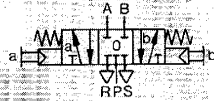

These blocked center valves will hold the piston of a double-acting cylinder in place under pressure.

For this reason, they are especially suited for positioning, emergency shut-down, and holding of double-acting cylinders in any desired position.

The separate ports R and S allow for regulating cylinder extension and retraction speeds independently by means of exhaust throttles.

Speed control valves must be used only at the exhaust ports to prevent cylinder creep.

Exhaust Throttles with Silencers. See pages 816-819.

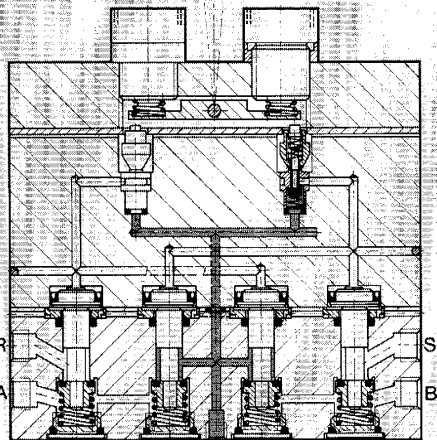

Type H-5/3-1/4

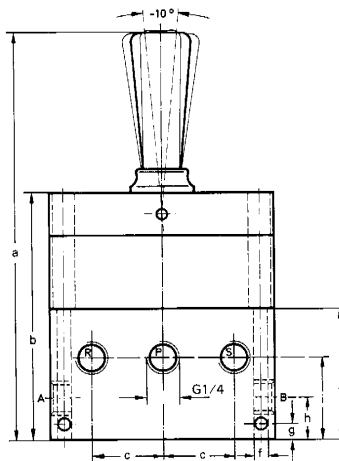
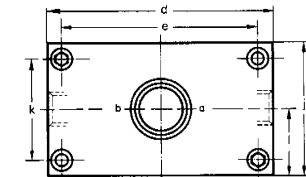

Type T-5/3-1/4

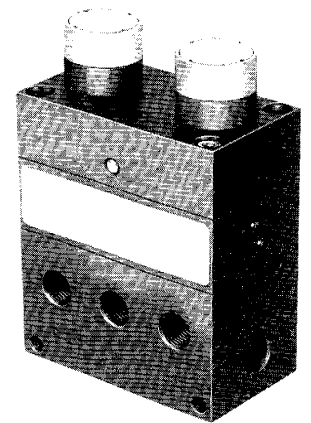
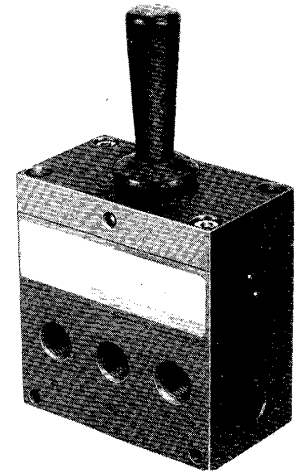
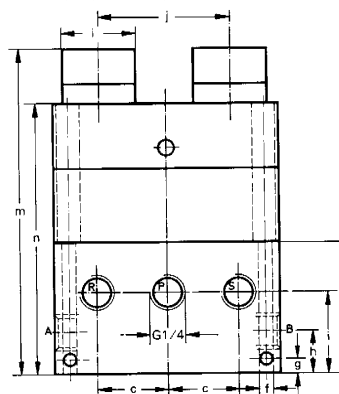
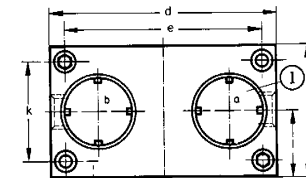

Dimensions

a	6.15 in / 156 mm	i	1.22 in / 32 mm
b	3.66 in / 93 mm	j	1.97 in / 50 mm
c	1.06 in / 27 mm	k	1.50 in / 38 mm
d	3.43 in / 87 mm	l	1.04 in / 26.5 mm
e	2.96 in / 75 mm	m	4.83 in / 122.7 mm
f	0.22 in / 5.5 mm	n	4.06 in / 103 mm
g	0.20 in / 5 mm	o	1.18 in / 30 mm
h	0.63 in / 16 mm		

- 1 (P) = Supply
- 2, 4 (A, B) = Outlet
- 3, 5 (R, S) = Exhaust

Order Number	4577 H-5/3-1/4	4578 T-5/3-1/4
Medium	Compressed air (filtered, lubricated or unlubricated)	
Mounting	Holes through housing	
Connection	G 1/4 ISO	
Orifice Size	0.28 in / 7 mm	
C _v Factor	0.68 C _v / 680 l/min	
Pressure Range	30-150 psi / 2-10 bar	
Operating Force at 90 psi / 6 bar Supply*	1.1 lbf / 5 N	1.8 lbf / 8 N
Design	Seat valve, piloted, spring centered	
Material	Housing: Al, blue anodized. Seals: Buna N.	
Weight	2.336 lb / 1.060 kg	2.557 lb / 1.160 kg

* 14 to 140°F / -10 to +60°C

Product Range and Company Overview

A Complete Suite of Automation Services

Our experienced engineers provide complete support at every stage of your development process, including: conceptualization, analysis, engineering, design, assembly, documentation, validation, and production.



Custom Automation Components
Complete custom engineered solutions



Custom Control Cabinets
Comprehensive engineering support and on-site services



Complete Systems
Shipment, stocking and storage services

The Broadest Range of Automation Components

With a comprehensive line of more than 30,000 automation components, Festo is capable of solving the most complex automation requirements.



Electromechanical
Electromechanical actuators, motors, controllers & drives



Pneumatics
Pneumatic linear and rotary actuators, valves, and air supply



PLCs and I/O Devices
PLC's, operator interfaces, sensors and I/O devices

Supporting Advanced Automation... As No One Else Can!

Festo is a leading global manufacturer of pneumatic and electromechanical systems, components and controls for industrial automation, with more than 12,000 employees in 56 national headquarters serving more than 180 countries. For more than 80 years, Festo has continuously elevated the state of manufacturing with innovations and optimized motion control solutions that deliver higher performing, more profitable automated manufacturing and processing equipment. Our dedication to the advancement of automation extends beyond technology to the education and development of current and future automation and robotics designers with simulation tools, teaching programs, and on-site services.

Quality Assurance, ISO 9001 and ISO 14001 Certifications

Festo Corporation is committed to supply all Festo products and services that will meet or exceed our customers' requirements in product quality, delivery, customer service and satisfaction.

To meet this commitment, we strive to ensure a consistent, integrated, and systematic approach to management that will meet or exceed the requirements of the ISO 9001 standard for Quality Management and the ISO 14001 standard for Environmental Management.



© Copyright 2008, Festo Corporation. While every effort is made to ensure that all dimensions and specifications are correct, Festo cannot guarantee that publications are completely free of any error, in particular typing or printing errors. Accordingly, Festo cannot be held responsible for the same. For Liability and Warranty conditions, refer to our "Terms and Conditions of Sale", available from your local Festo office. All rights reserved. No part of this publication may be reproduced, distributed, or transmitted in any form or by any means, electronic, mechanical, photocopying or otherwise, without the prior written permission of Festo. All technical data subject to change according to technical update.



Printed on recycled paper at New Horizon Graphic, Inc., FSC certified as an environmentally friendly printing plant.

Festo North America

United States

Customer Resource Center

502 Earth City Expy., Suite 125
Earth City, MO 63045

For ordering assistance, or to find
your nearest Festo Distributor,

Call: 1.800.99.FESTO

Fax: 1.800.96.FESTO

Email: customer.service@us.festo.com

For technical support,

Call: 1.866.GO.FESTO

Fax: 1.800.96.FESTO

Email: product.support@us.festo.com

Headquarters

Festo Corporation
395 Moreland Road
P.O. Box 18023
Hauppauge, NY 11788
www.festo.com/us

Sales Offices

Appleton

N. 922 Tower View Drive, Suite N
Greenville, WI 54942

Boston

120 Presidential Way, Suite 330
Woburn, MA 01801

Chicago

1441 East Business Center Drive
Mt. Prospect, IL 60056

Dallas

1825 Lakeway Drive, Suite 600
Lewisville, TX 75057

Detroit - Automotive Engineering Center

2601 Cambridge Court, Suite 320
Auburn Hills, MI 48326

New York

395 Moreland Road
Hauppauge, NY 11788

Silicon Valley

4935 Southfront Road, Suite F
Livermore, CA 94550

Design and Manufacturing Operations



East: 395 Moreland Road, Hauppauge, NY 11788



Central: 1441 East Business Center Drive, Mt. Prospect, IL 60056



West: 4935 Southfront Road, Suite F, Livermore, CA 94550

Mexico

Headquarters

Festo Pneumatic, S.A.
Av. Ceylán 3, Col. Tequesquahuac
54020 Tlalnepantla, Edo. de México
Call: 011 52 [55] 53 21 66 00
Fax: 011 52 [55] 53 21 66 65
Email: festo.mexico@mx.festo.com
www.festo.com/mx



Canada

Headquarters

Festo Inc.
5300 Explorer Drive
Mississauga, Ontario L4W 5G4
Call: 1.905.624.9000
Fax: 1.905.624.9001
Email: info.ca@ca.festo.com
www.festo.com/ca



Festo Worldwide

Argentina Australia Austria Belarus Belgium Brazil Bulgaria Canada Chile China Colombia Croatia Czech Republic Denmark
Estonia Finland France Germany Great Britain Greece Hong Kong Hungary India Indonesia Iran Ireland Israel Italy Japan
Latvia Lithuania Malaysia Mexico Netherlands New Zealand Norway Peru Philippines Poland Romania Russia Serbia Singapore
Slovakia Slovenia South Africa South Korea Spain Sweden Switzerland Taiwan Thailand Turkey Ukraine United States Venezuela

www.festo.com