

Parallel grippers HGPM, micro

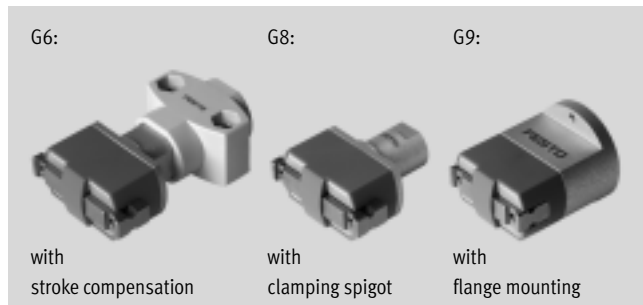

Parallel grippers HGPM, micro

Key features



At a glance

- Compact, handy design
- With open or closed gripper jaws
- Versatility thanks to externally adaptable gripper fingers
- Wide range of options for attaching drive units
- With stroke compensation after installation
- Mounting options:
 - Clamping spigot
 - Flange mounting

- [Note icon] - Note
 Sizing software
 Gripper selection
 → www.festo.com

Mounting options for external gripper fingers (customer-specific)

- 1 Parallel gripper
- 2 External gripper fingers
- 3 Mounting screws

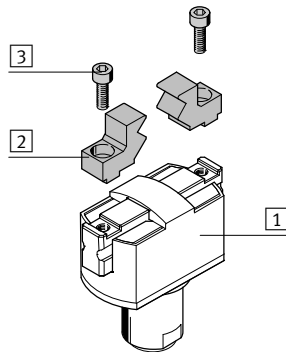

- [Note icon] - Note
 Grippers are not suitable for the following, or for similar applications:

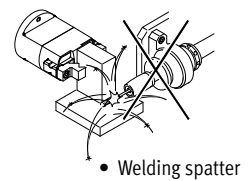
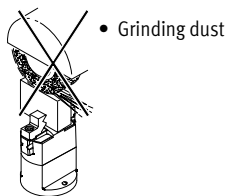
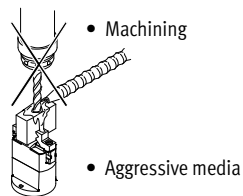

Parallel grippers HGPM, micro

Key features

FESTO

Mounting options

With through-holes

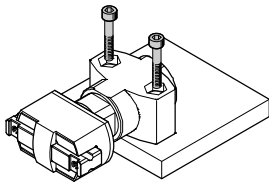

With through-holes, screws and retaining nuts

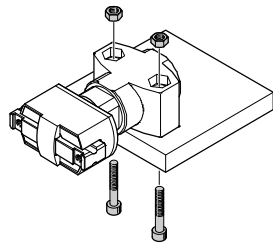

With flange mounting, screws and dowel pins
Direct air supply

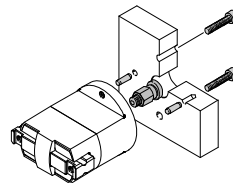

Integrated air supply

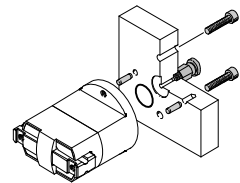

With set screw

Direct air supply

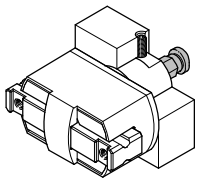

Integrated air supply

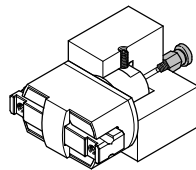

System product for handling and assembly technology

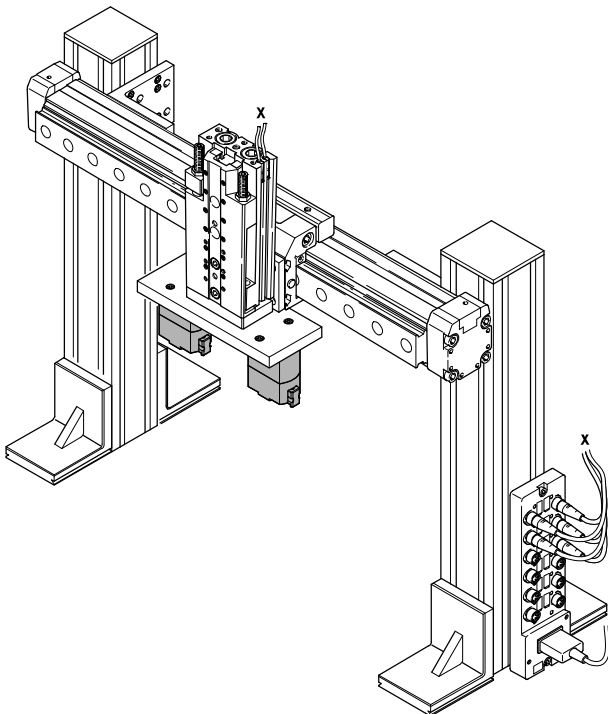

	→ Page/Internet
Drives	drive
Grippers	gripper
Adapters	adapter kit
Basic mounting components	basic component
Installation components	installation component
Axes	axes
Motors	motor

Parallel grippers HGPM, micro

Type codes

HGPM – 12 – EO – G8

Type	
HGPM	Parallel gripper

Size	

Gripper jaw position	
EO	Open
EZ	Closed

Mounting options	
G6	With stroke compensation
G8	With clamping spigot
G9	With flange mounting

Parallel grippers HGPM, micro

Technical data



Function

Single-acting
with open gripper jaws
HGPM-...-EO-G...



with closed gripper jaws
HGWM-...-EZ-G...



-  Size
8 ... 12 mm
-  Stroke
4 ... 6 mm

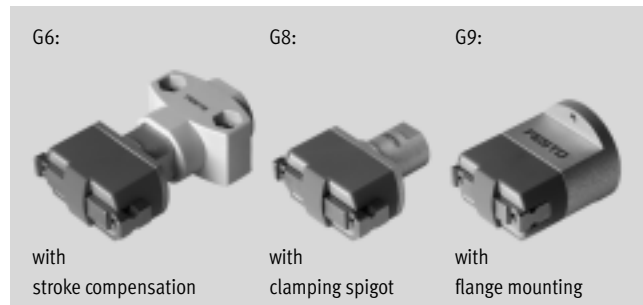

General technical data			
Size		8	12
Constructional design		Wedge-shaped drive	
Mode of operation		Single-acting	
Gripper function		Parallel	
Number of gripper jaws		2	
Max. weight force per external gripper finger ¹⁾	[N]	0.05	0.15
Resetting force ²⁾	Gripper jaws open	[N]	1.5
	Gripper jaws closed	[N]	2
Stroke per gripper jaw	[mm]	2	3
Pneumatic connection		M3	
Repetition accuracy ^{3) 4)}	[mm]	< 0.05	
Max. interchangeability	[mm]	0.4	
Max. operating frequency	[Hz]	4	
Centring precision ⁴⁾	[mm]	< Ø 0.15 (valid only for HGPM-...-G8 and HGPM-...-G9)	
Position sensing		Without	
Type of mounting	HGPM-...-E...-G6	Via through-holes	
	HGPM-...-E...-G8	Clamped	
	HGPM-...-E...-G9	With female thread and locating hole	

- 1) Valid for unthrottled operation
- 2) Spring resetting force between the jaws
- 3) End position drift under constant conditions of use with 100 consecutive strokes in the direction of movement of the gripper jaws
- 4) The indicated values are only valid when gripping with compressed air, not with spring force

Operating and environmental conditions			
Min. operating pressure	[bar]	4	
Max. operating pressure	[bar]	8	
Operating medium		Compressed air in accordance with ISO 8573-1:2010 [7:4:4]	
Note on operating/pilot medium		Operation with lubricated medium possible (in which case lubricated operation will always be required)	
Ambient temperature	[°C]	+5 ... +60	
Corrosion resistance class CRC ¹⁾		1	

- 1) Corrosion resistance class 1 according to Festo standard 940 070
Components requiring low corrosion resistance. Transport and storage protection. Parts that do not have primarily decorative surface requirements, e.g. in internal areas that are not visible or behind covers

Weights [g]			
Size		8	12
With stroke compensation		19	62
With clamping spigot		11	41
With flange mounting		18	62

Parallel grippers HGPM, micro

Technical data

Materials

Sectional view

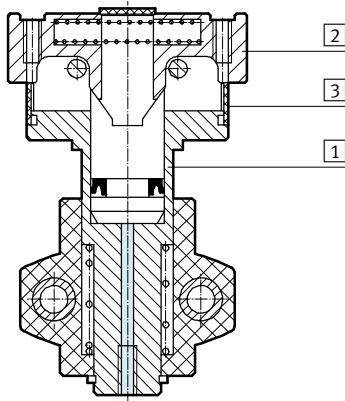

Parallel gripper

1	Body	Anodised aluminium
2	Gripper jaw	Stainless steel
3	Cover cap	Polyacetate
-	Note on materials	Copper and PTFE Conforms to RoHS

Gripping force [N] at 6 bar

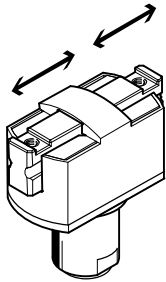

Size	8		12	
	HGPM-...EO-...	HGPM-...EZ-...	HGPM-...EO-...	HGPM-...EZ-...
Gripping force per gripper jaw				
Opening	-	8	-	17.5
Closing	8	-	13.5	-
Total gripping force				
Opening	-	16	-	35
Closing	16	-	27	-

Characteristic load values per gripper jaw

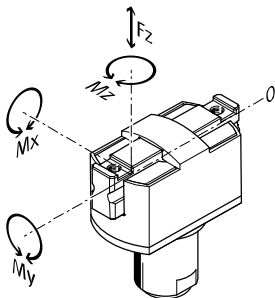

The indicated permissible forces and torques apply to a single gripper jaw. The indicated values include the lever arm, additional applied loads caused

by the workpiece or external gripper fingers, as well as forces which occur during movement. The zero co-ordinate line (gripper jaw

guide slot) must be taken into consideration for the calculation of torques.

Size		8	12
Max. permissible force F_z	[N]	10	30
Max. permissible torque M_x	[Nm]	0.15	0.5
Max. permissible torque M_y	[Nm]	0.15	0.5
Max. permissible torque M_z	[Nm]	0.15	0.5

Parallel grippers HGPM, micro

Technical data

FESTO

Mass moment of inertia [kgm²x10⁻⁴]

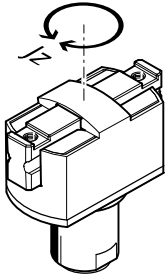

Mass moment of inertia [kgm²x10⁻⁴] for parallel grippers in relation to the central axis, without external gripper fingers, without load.

Size	8	12
With stroke compensation	0.00922	0.06674
With clamping spigot	0.00573	0.04252
With flange mounting	0.01712	0.07939

Opening and closing times [ms] at 6 bar

Without external gripper fingers

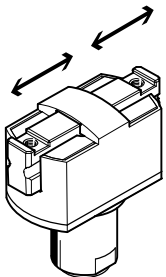

The indicated opening and closing times [ms] have been measured at room temperature and 6 bar operating pressure with vertically mounted gripper and without external gripper fingers. Load is increased if external gripper fingers are attached. This means that kinetic energy is also

increased, as this is determined by gripper finger weight and velocity. If permissible kinetic energy is exceeded, various parts of the gripper may be damaged. This occurs when the applied load reaches the end-position and the cushioning is only

able to partially convert the kinetic energy into potential energy and heat energy. It thus becomes apparent that the indicated max. permissible applied load due to the external gripper fingers must be checked and maintained.

Size	8	12	
HGPM-...EO-...	Opening	4.9	11
	Closing	2.3	3.7
HGPM-...EZ-...	Opening	1.9	3
	Closing	4.1	8.3

Gripper jaw backlash

Without external gripper fingers

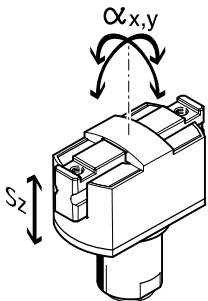

With parallel grippers, backlash occurs between the gripper jaws and the guide element due to the plain-bearing guide. The backlash values listed in the table have been

calculated based upon the traditional accumulative tolerance method and usually do not occur with mounted grippers.

Size	8	12
Gripper jaw backlash s_z	[mm]	< 0.03
Gripper jaw angular backlash a_x, a_y	[°]	< 0.5

Parallel grippers HGPM, micro

Technical data

Spring displacement forces [N]

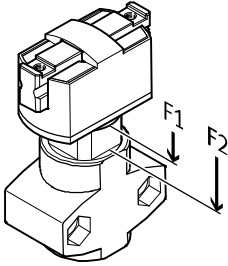

Theoretical actuating force due to stroke compensation for design variant with stroke compensation.

Size	8	12
Spring displacement forces F_1	4	10
Spring displacement forces F_2	6	23

Gripping force F_{Grip} per gripper jaw as a function of operating pressure and lever arm x

External and internal gripping (closing and opening)

Gripping forces related to operating pressure and lever arm can be determined for the various sizes using the following graphs.

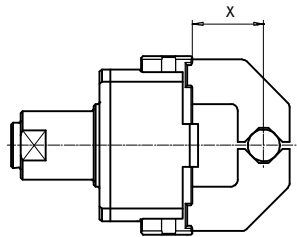

EO = External gripping (closing)

EZ = Internal gripping (opening)

HGPM-08-EO-...

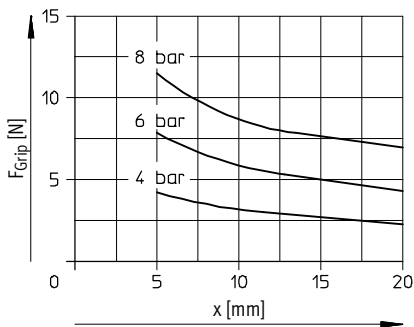

HGPM-08-EZ-...

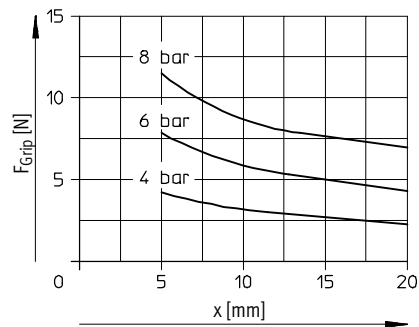

HGPM-12-EO-...

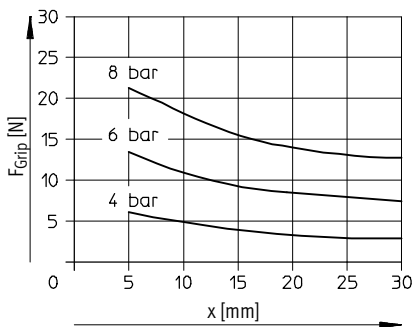

HGPM-12-EZ-...

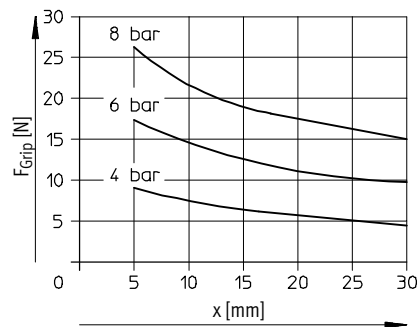

Parallel grippers HGPM, micro

Technical data

Gripping force F_{Grip} per gripper jaw at 6 bar as a function of lever arm x and eccentricity y

External and internal gripping (closing and opening)

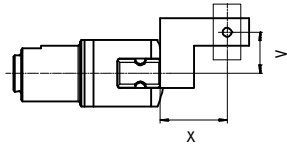

Gripping forces at 6 bar dependent upon eccentric application of force and the maximum permissible off-

centre point of force application can be determined for the various sizes using the following graphs.

Calculation example

Given:

HGPM-12-EZ-...

Lever arm $x = 10$ mm

Eccentricity $y = 11$ mm

To be found:

Gripping force at 6 bar

Procedure:

- Determine the intersection xy between lever arm x and eccentricity y in the graph for HGPM-12-EZ
 - Draw an arc (with centre at origin) through intersection xy
 - Determine the intersection between the arc and the X axis
 - Read the gripping force
- Result:
Gripping force = approx. 15 N

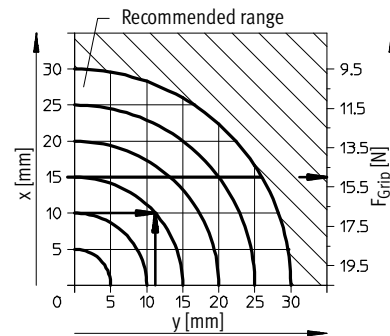

HGPM-08-E0-...

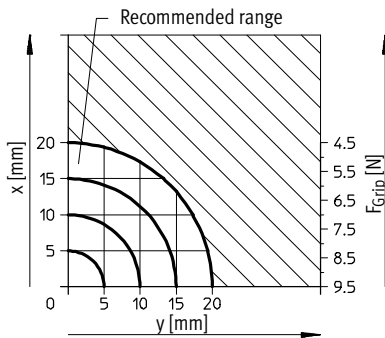

HGPM-08-EZ-...

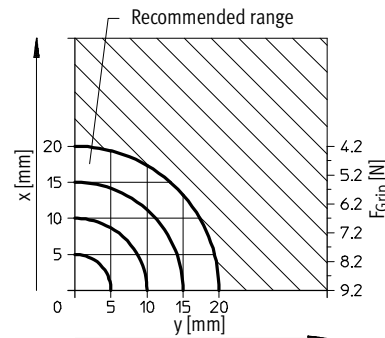

HGPM-12-E0-...

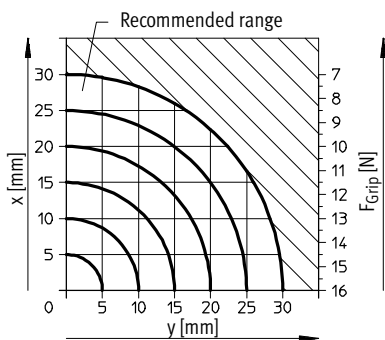

HGPM-12-EZ-...

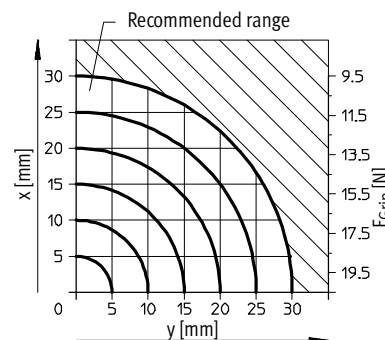

E0 = External gripping (closing)

EZ = Internal gripping (opening)

Parallel grippers HGPM, micro

Technical data

FESTO

Dimensions

Download CAD data → www.festo.com

With stroke compensation – HGPM-...-E...-G6

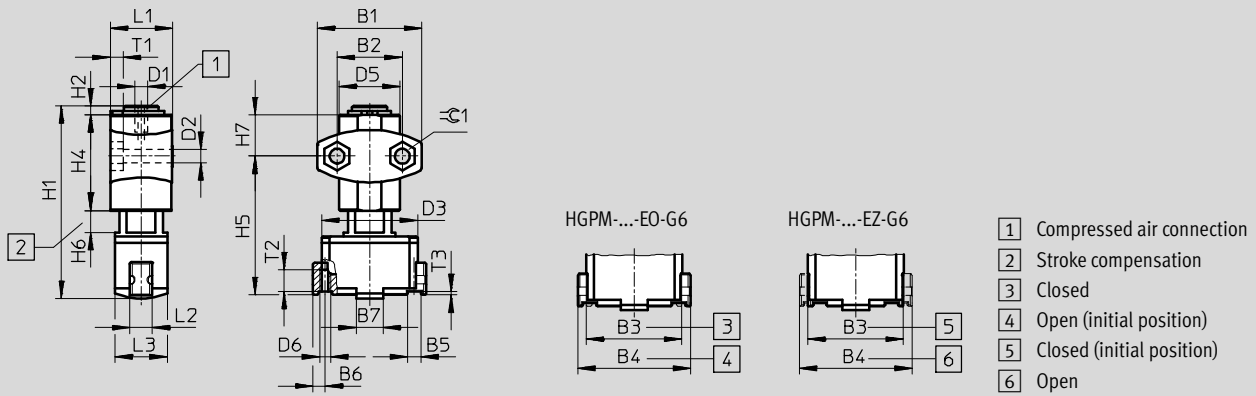

With clamping spigot – HGPM-...-E...-G8

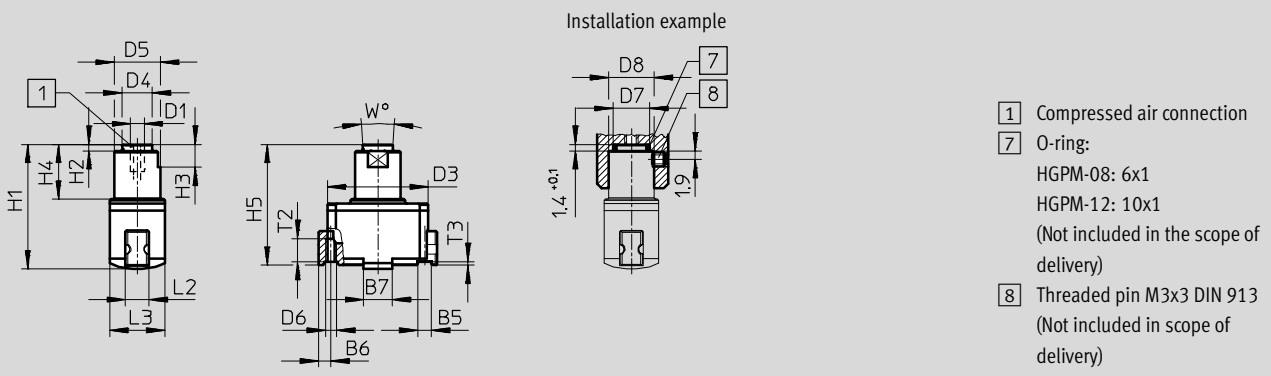

With flange mounting – HGPM-...-E...-G9

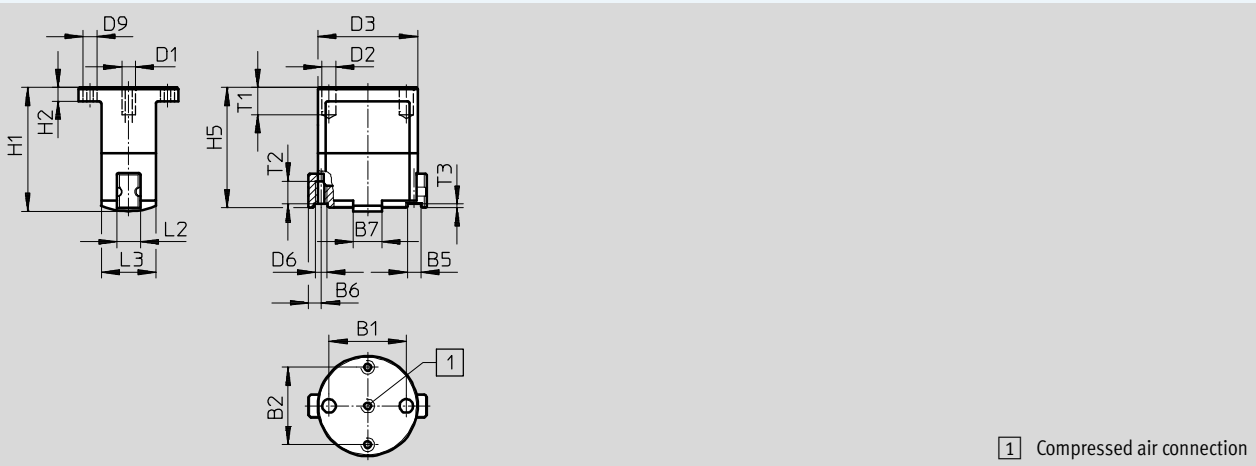

Parallel grippers HGPM, micro

Technical data

Type	B1	B2	B3 ±0.3	B4 ±0.3	B5 +0.05/+0.02	B6 +0.19/-0.23	B7 ±0.1	D1	D2 ∅	D3 ∅
HGPM-08-EO-G6	24 ±0.1	15 ±0.25	22	26	3	2.75	6.2	M3	3.4 +0.2	22
HGPM-08-EZ-G6										
HGPM-12-EO-G6	35 ±0.1	24 ±0.25	33	39	4	4	9	M3	4.5 +0.2	33
HGPM-12-EZ-G6										
HGPM-08-EO-G8	-	-	22	26	3	2.75	6.2	M3	-	22
HGPM-08-EZ-G8										
HGPM-12-EO-G8	-	-	33	39	4	4	9	M3	-	33
HGPM-12-EZ-G8										
HGPM-08-EO-G9	17 ±0.02	17 ±0.1	22	26	3	2.75	6.2	M3	3 F8	22
HGPM-08-EZ-G9										
HGPM-12-EO-G9	27 ±0.02	27 ±0.1	33	39	4	4	9	M3	3 F8	33
HGPM-12-EZ-G9										

Type	D4 ∅ ±0.1	D5 ∅	D6	D7 ∅ +0.1	D8 ∅ +0.1	D9	H1 ±0.3	H2	H3	H4	H5
HGPM-08-EO-G6	-	15 ±0.5	M2.5	-	-	-	44.2	2 +0.1/-0.3	-	22 -0.3	32.4 +0.8/-0.65
HGPM-08-EZ-G6											
HGPM-12-EO-G6	-	22 ±0.5	M3	-	-	-	63	3 +0.2/-0.3	-	29 -0.3	46.65 +0.9/-0.7
HGPM-12-EZ-G6											
HGPM-08-EO-G8	6.6	10 h8	M2.5	8	10	-	27.2	1.4 -0.1	5	12 ±0.1	26.9 +0.2/-0.25
HGPM-08-EZ-G8											
HGPM-12-EO-G8	10.6	15 h8	M3	12	15	-	41	1.4 -0.1	7 ±0.1	18 ±0.1	40.15 +0.2/-0.25
HGPM-12-EZ-G8											
HGPM-08-EO-G9	-	-	M2.5	-	-	M3	27.2	3 ±0.2	-	-	26.9 +0.2/-0.25
HGPM-08-EZ-G9											
HGPM-12-EO-G9	-	-	M3	-	-	M3	41	5 ±0.2	-	-	40.15 +0.2/-0.25
HGPM-12-EZ-G9											

Type	H6 +0.7/-0.2	H7 ±0.3	L1 +0.1/-0.3	L2 -0.1	L3 ±0.1	T1	T2 ¹⁾	T3	W	≲C1
HGPM-08-EO-G6	0 ... 5	9.5	14.3	5	12	3 -0.2	4	0.8	-	5.7
HGPM-08-EZ-G6										
HGPM-12-EO-G6	0 ... 8	12.5	20.35	7	18	4 -0.2	6	1	-	7.5
HGPM-12-EZ-G6										
HGPM-08-EO-G8	-	-	-	5	12	-	4	0.8	8°	-
HGPM-08-EZ-G8										
HGPM-12-EO-G8	-	-	-	7	18	-	6	1	8°	-
HGPM-12-EZ-G8										
HGPM-08-EO-G9	-	-	-	5	12	min. 6	4	0.8	-	-
HGPM-08-EZ-G9										
HGPM-12-EO-G9	-	-	-	7	18	min. 6	6	1	-	-
HGPM-12-EZ-G9										

1) Do not exceed max. thread screw-in depth

Ordering data							
Single-acting	Size [mm]	Mounting options					
		With stroke compensation		With clamping spigot		With flange mounting	
		Part No.	Type	Part No.	Type	Part No.	Type
Gripper jaws open	8	197559	HGPM-08-EO-G6	197560	HGPM-08-EO-G8	197561	HGPM-08-EO-G9
	12	197565	HGPM-12-EO-G6	197566	HGPM-12-EO-G8	197567	HGPM-12-EO-G9
Gripper jaws closed	8	197562	HGPM-08-EZ-G6	197563	HGPM-08-EZ-G8	197564	HGPM-08-EZ-G9
	12	197568	HGPM-12-EZ-G6	197569	HGPM-12-EZ-G8	197570	HGPM-12-EZ-G9