

Mini slides EGSL, electric



Mini slides EGSL, electric

Key features



At a glance

- Electric slide series
- Maximum performance in compact space:
 - Precision
 - Load capacity
 - Dynamic response
- Choice of homing:
 - To fixed stop
 - To reference switch
- Perfect for vertical applications
- System product for handling and assembly technology
- Wide range of options for mounting on drives

Motor mounting variants

Axial

Parallel



Characteristic values of the axes

The specifications shown in the table are maximum values.

The precise values for each of the variants can be found in the relevant technical data.

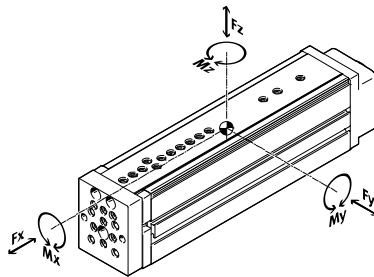

Version	Size	Working stroke [mm]	Speed [m/s]	Max. acceleration [m/s ²]	Repetition accuracy [mm]	Feed force Fx [N]	Guide characteristics				
							Forces and torques				
							Fy [N]	Fz [N]	Mx [Nm]	My [Nm]	Mz [Nm]
	35	50	0.5	25	±0.015	75	512	512	6.2	6.0	6.0
	45	100, 200	1.0	25	±0.015	150	631	631	18.6	16.3	16.3
	55	100, 200, 250	1.0	25	±0.015	300	1047	1047	33.1	33.3	33.3
	75	100, 200, 300	1.3	25	±0.015	450	1539	1539	67.4	47.1	47.1

- - Note

PositioningDrives
sizing software
www.festo.com

Mini slides EGSL, electric

Key features

Complete system comprising mini slide, motor, motor controller and motor mounting kit

Mini slide



Motor

→ 22



- 1 Servo motor EMME-AS, EMMS-AS
- 2 Stepper motor EMMS-ST

 Note
A range of specially adapted complete solutions is available for the mini slide EGSL and the motors.

Motor controller

Technical data → Internet: motor controller



- 1 Servo motor controller CMMP-AS
- 2 Stepper motor controller EMMS-ST

Motor mounting kit

→ 22

Axial kit

Parallel kit



There are complete kits for both parallel and axial motor mounting.

Mini slides EGSL, electric

Key features and type codes

System product for handling and assembly technology

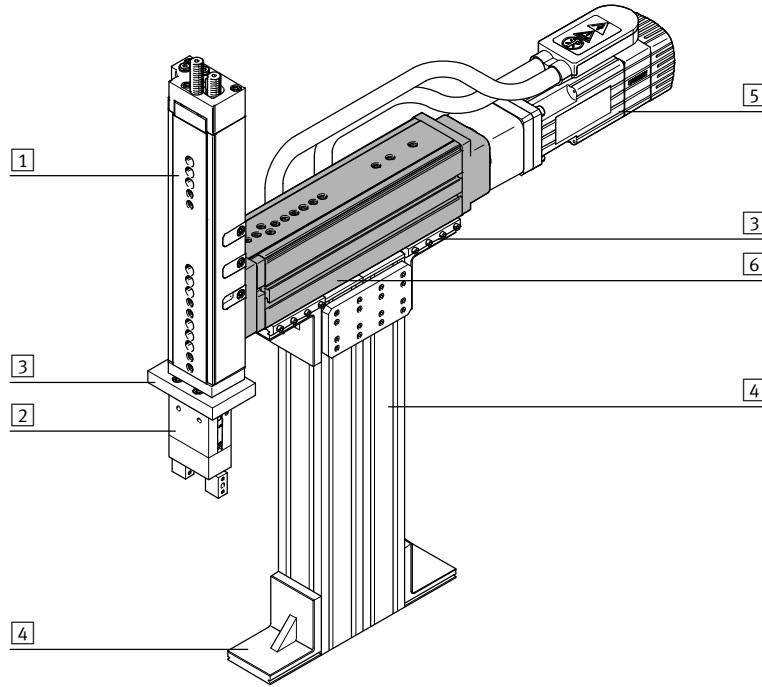

System components and accessories		
	Description	→ Page/Internet
1	Drives	Wide range of combinations possible within handling and assembly technology drive
2	Grippers	Wide range of variations possible within handling and assembly technology gripper
3	Adapters	For drive/drive connections 31
		For drive/gripper connections gripper
4	Basic components	Profiles and profile connections as well as profile/drive connections basic component
5	Motors	Servo and stepper motors, with or without gearing motor
6	Axes	Wide range of combinations possible within handling and assembly technology axis
-	Installation components	For a clear, safe layout of electrical cables and tubing installation component

Type codes

	EGSL	-	BS	-	45	-	200	-	10P
Type									
EGSL	Mini slide								
Drive function									
BS	Ball screw spindle								
Size									
Stroke [mm]									
Spindle pitch [mm]									

Mini slides EGSL, electric

Peripherals overview

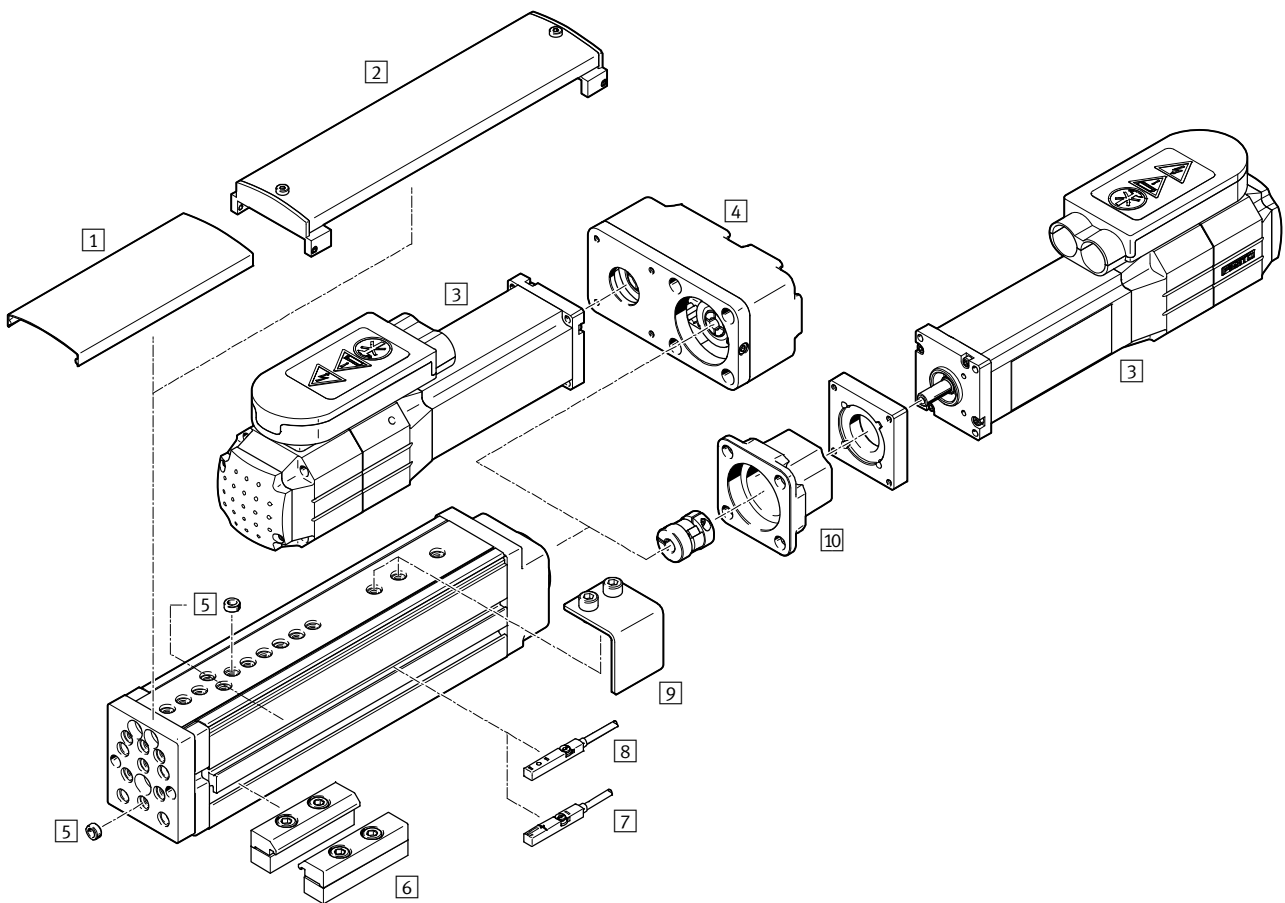

Variants and accessories		
Type	Description	→ Page/Internet
1 Cover EASC-...	<ul style="list-style-type: none"> For protection, so that no foreign parts can get into the guide The cover can be shortened by the customer as required 	29
2 Cover EASC-...F	<ul style="list-style-type: none"> This cover must be used in combination with the switching lug EAPM For protection, so that no foreign parts can get into the guide 	29
3 Motor EMMe, EMMS	Motors specially matched to the axis, with or without brake	22
4 Parallel kit EAMM-U	<ul style="list-style-type: none"> For parallel motor mounting The motor can only be mounted at the side and underneath (comprising: housing, clamping sleeve, toothed belt pulley, toothed belt) 	26
5 Centring sleeve ZBH	<ul style="list-style-type: none"> For centring loads and attachments Makes lateral mounting on the slide much easier 	30
6 Profile mounting EAHF, MUE	For mounting the axis	28
7 Proximity sensor SIES-8M	Inductive proximity sensor, for slot type 8	30
8 Proximity sensor SMT-8	Magnetic proximity sensor, for slot type 8	30
9 Switching lug EAPM	For sensing the slide position via proximity sensors SIES	28
10 Axial kit EAMM-A	For axial motor mounting (comprising: coupling, coupling housing and motor flange)	22
- Connecting cable NEBU	For proximity sensor SIES or SMT-8-...-B	30

Mini slides EGSL, electric

Technical data

FESTO

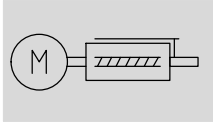

Function



Note

All values are based on a room temperature of 20 °C.



-  - Size
35, 45, 55, 75
-  - Stroke length
50 ... 300 mm

General technical data								
Size		35	45		55		75	
Spindle pitch	[mm]	8	3	10	5	12.7	10	20
Design		Electric mini slide						
		With recirculating ball spindle						
		With guide						
Guide		Ball bearing cage guide						
Type of mounting		Via female thread						
		Via centring sleeve						
		Via accessories						
Mounting position		Any						
Working stroke	[mm]	50	100, 200		100, 200, 250		100, 200, 300	
Max. permissible applied load, horizontal	[kg]	2	6		10		14	
Max. permissible applied load, vertical	[kg]	2	6		10		14	
Continuous feed force F_x	[N]	50	100		200		300	
Max. feed force F_x	[N]	75	150		300		450	
Max. no-load driving torque	[Nm]	0.015	0.090	0.080	0.100	0.135	0.265	0.165
Max. driving torque ¹⁾	[Nm]	0.2	0.45	0.51	0.9	1.25	3.25	3.25
Max. radial force ²⁾	[N]	20	120		260		300	
Max. speed	[m/s]	0.5	0.3	1.0	0.4	1.0	0.65	1.3
Nominal acceleration	[m/s ²]	15						
Max. acceleration ³⁾	[m/s ²]	25						
Repetition accuracy	[mm]	±0.015						
Max. reversing backlash ⁴⁾	[µm]	≤50						

- 1) Friction and acceleration torque of the rotating load taken into consideration
- 2) At the drive shaft
- 3) The max. acceleration is dependent on the moving load, the driving torque and the max. feed force
- 4) In new condition

Operating and environmental conditions					
Size		35	45	55	75
Ambient temperature	[°C]	0 ... +60			
Protection class		IP40			
Duty cycle	[%]	100			
Noise level	[dB (A)]	60		65	
Maintenance interval		Maintenance-free			

Mini slides EGSL, electric

Technical data

Weight [kg]			
Size	35		45
Stroke [mm]	50	100	200
Product weight	0.6	1.6	2.2
Moving load	0.3	0.7	0.9
Dead weight of guide rail and yoke plate	0.13	0.4	0.58

Size	55			75		
Stroke [mm]	100	200	250	100	200	300
Product weight	2.6	3.4	4.1	5.1	6.5	8.1
Moving load	1.2	1.5	1.8	2.3	2.9	3.4
Dead weight of guide rail and yoke plate	0.61	0.87	1.07	1.2	1.64	2.07

Mass moment of inertia – for sizing the motor								
Size	35				45			
Spindle pitch [mm]	8				3		10	
Stroke [mm]	50				100	200	100	200
J_0 [kg mm ²]	4.26				4.59	5.14	6.14	7.31
J_L per kg effective load [kg mm ² /kg]	1.62				0.23	0.23	2.53	2.53

Size	55						75					
Spindle pitch [mm]	5			12.7			10			20		
Stroke [mm]	100	200	250	100	200	250	100	200	300	100	200	300
J_0 [kg mm ²]	13.52	14.77	15.74	18.27	21.13	23.27	86.95	96.49	106.67	105.12	119.45	134.59
J_L per kg effective load [kg mm ² /kg]	0.63	0.63	0.63	4.09	4.09	4.09	2.53	2.53	2.53	10.13	10.13	10.13

The mass moment of inertia J_A of the entire axis is calculated as follows:

$$J_A = J_0 + J_L \times m_{\text{effective load}} \text{ [kg]}$$

The inertia of the motor mounting kit and motor is not taken into consideration here.

Materials

Sectional view

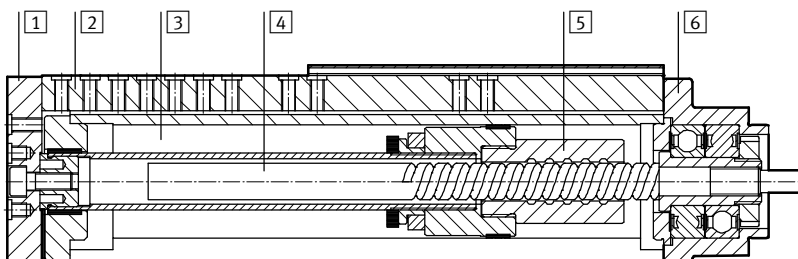

Axis	
1	Yoke plate Anodised wrought aluminium alloy
2	Guide rail Rolled steel
3	Housing Anodised wrought aluminium alloy
4	Spindle Rolled steel
5	Spindle nut Rolled steel
6	End cap Painted aluminium
Note on materials RoHS-compliant Contains PWIS (paint-wetting impairment substances)	

Mini slides EGSL, electric

Technical data

Possible combinations

Via guide

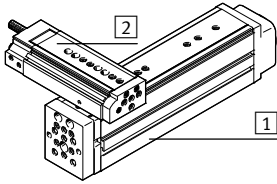

Direct mounting

		1 Basic drive							
		EGSL-35		EGSL-45		EGSL-55		EGSL-75	
2 Assembly drive	EGSL-35	1088327	HMSV-73	1088338	HMSV-74	1088338	HMSV-74	-	
	EGSL-45	-		1088338	HMSV-74	1088338	HMSV-74	1089092	HMSV-75
	EGSL-55	-		-		1088338	HMSV-74	1089092	HMSV-75
	EGSL-75	-		-		-		1089092	HMSV-75
	DGSL-4	1088327	HMSV-73	-		-		-	
	DGSL-6	1088327	HMSV-73	-		-		-	
	DGSL-8	1088327	HMSV-73	ZBV-M5-7	ZBV-M5-7		-		
	DGSL-10	1088327	HMSV-73	ZBV-M5-7	ZBV-M5-7		-		
	DGSL-12	-	-	M5x14 ZBH-7	M5x16 ZBH-7		ZBV-M6-9		
	DGSL-16	-	-	M5x14 ZBH-7	M5x16 ZBH-7		ZBV-M6-9		
DGSL-20	-	-	-		-		M6x20 ZBH-9		

Via yoke plate

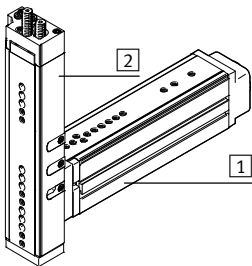

Direct mounting

		1 Basic drive							
		EGSL-35		EGSL-45		EGSL-55		EGSL-75	
2 Assembly drive	EGSL-35	M4x12 ZBH-7	1088295 HMSV-71		1088295	HMSV-71	-		
	EGSL-45	-	M5x12 ZBH-7	M5x14 ZBH-7		1088311 HMSV-72			
	EGSL-55	-	-		M5x14 ZBH-7	1088311 HMSV-72			
	EGSL-75	-	-		-		M6x18 ZBH-9		
	DGSL-4	1088262	HMSV-70	-		-		-	
	DGSL-6	1088262	HMSV-70	-		-		-	
	DGSL-8	1088262	HMSV-70	ZBV-M5-7	ZBV-M5-7		-		
	DGSL-10	1088262	HMSV-70	ZBV-M5-7	ZBV-M5-7		-		
	DGSL-12	-	-	M5x14 ZBH-7	M5x12 ZBH-7		ZBV-M6-9		
	DGSL-16	-	-	M5x14 ZBH-7	M5x12 ZBH-7		ZBV-M6-9		
DGSL-20	-	-	-		-		M6x20 ZBH-9		

-  - Note

Ordering data for centring sleeves
ZBH and connecting sleeves ZBV
→ 30.

Mini slides EGSL, electric

Technical data

Parallelism [mm]

The term parallelism refers to the accuracy of alignment between the mounting surface and the slide surface.

Specifications apply in retracted state.

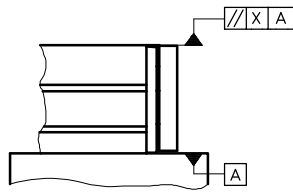

Size	Stroke [mm]	35	45	55	75
Parallelism X	50	0.03	–	–	–
	100	–	0.05	0.05	0.05
	200	–	0.1	0.1	0.1
	250	–	–	0.125	–
	300	–	–	–	0.15

Linearity [mm]

Linearity refers to the max. difference between normal position and the reference plane experienced at any point of the moving axis components when traversing the entire stroke.

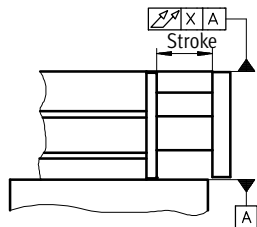

Size	Stroke [mm]	35	45	55	75
Linearity X	50	0.02	–	–	–
	100	–	0.04	0.04	0.04
	200	–	0.08	0.08	0.08
	250	–	–	0.10	–
	300	–	–	–	0.12

Mini slides EGSL, electric

Technical data

Dynamic characteristic load values

The indicated forces and torques refer to the centre of the guide.

These values must not be exceeded during dynamic operation.

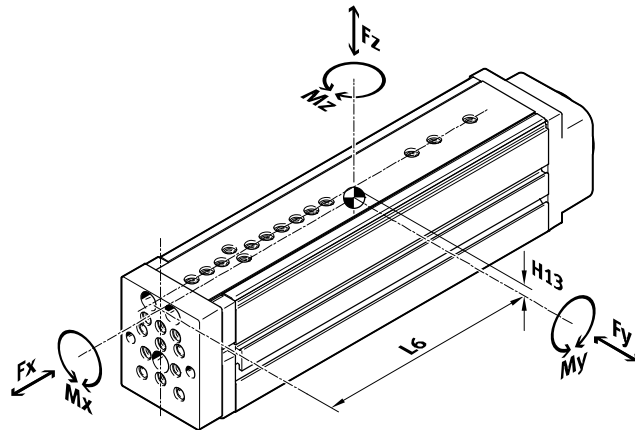

If the axis is subjected to more than two of the indicated forces and torques simultaneously, the following equation (guide comparison index f_v) must be satisfied in addition to the indicated maximum loads:

$$f_v = \frac{|F_{y,dyn}|}{F_{y,max.}} + \frac{|F_{z,dyn}|}{F_{z,max.}} + \frac{|M_{x,dyn}|}{M_{x,max.}} + \frac{|M_{y,dyn}|}{M_{y,max.}} + \frac{|M_{z,dyn}|}{M_{z,max.}}$$

Permissible forces and torques						Geometric characteristics		
Size	Stroke	$F_{y,max}$	$F_{z,max}$	$M_{x,max}$	$M_{y,max}, M_{z,max}$	H13	L6	
	[mm]	[N]	[N]	[Nm]	[Nm]		[mm]	retracted [mm]
35								
	50	512	512	6.2	6.0	4.2	83	106
45								
	100	631	631	18.6	16.3	6.4	114	162
	200	291	291	14.3	12.3	6.4	164	262
55								
	100	1047	1047	33.1	31.0	6.4	132	180
	200	490	490	24.2	22.6	6.4	182	280
	250	563	563	27.0	33.3	6.4	221	344
75								
	100	1539	1539	67.4	47.1	7.6	139	187
	200	714	714	48.5	33.8	7.6	189	287
	300	555	555	46.4	36.5	7.6	241	389

-  - Note
PositioningDrives
sizing software
www.festo.com

Mini slides EGSL, electric

Technical data

Position of the guide centre

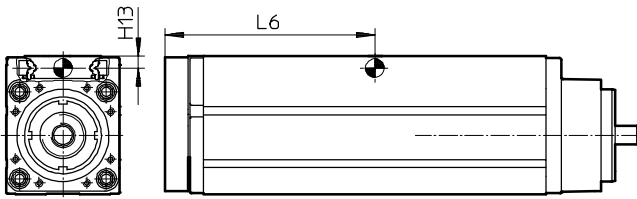

Calculation example

Given:

Type: EGSL-BS-45-100-10P
 Stroke length = 100 mm
 Lever arm L_x = 30 mm
 Lever arm L_y = 10 mm
 Mass F_z = 5 kg
 Acceleration a = 0 m/s^2
 Mounting position: Horizontal

To be calculated:

- F_y, F_z, M_x, M_y, M_z
- Verification of operation with combined load
- Service life estimate

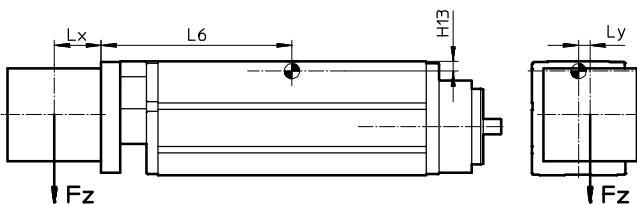

Solution:

$$L6 = 0.162 \text{ m from table}$$

$$F_y = 0 \text{ N}$$

$$F_z = m \times g \\ = 5 \text{ kg} \times 9.81 \text{ m/s}^2 = 49.05 \text{ N}$$

$$M_x = F_z \times L_y \\ = 49.05 \text{ N} \times 0.01 \text{ m} = 0.4905 \text{ Nm}$$

$$M_y = F_z \times (L6 + L_x) \\ = 49.05 \text{ N} \times (0.162 \text{ m} + 0.03 \text{ m}) = 9.42 \text{ Nm}$$

$$M_z = 0 \text{ Nm}$$

Combined load:

$$\frac{|F_y|}{F_{y_{\max}}} + \frac{|F_z|}{F_{z_{\max}}} + \frac{|M_x|}{M_{x_{\max}}} + \frac{|M_y|}{M_{y_{\max}}} + \frac{|M_z|}{M_{z_{\max}}} \\ = 0 + \frac{49.05 \text{ N}}{631 \text{ N}} + \frac{0.49 \text{ Nm}}{18.6 \text{ Nm}} + \frac{9.42 \text{ Nm}}{16.3 \text{ Nm}} + 0 = 0.68$$

The diagram on page 12 shows a service life of approx. 30 million cycles when $f_v = 0.68$.

Mini slides EGSL, electric

Technical data

Calculating service life

The service life of the guide depends on the load. To provide a rough indication of the service life of the guide, the graph below plots the load comparison factor f_v against the service life.

The spindle module even exceeds the guide's high load capacity and service life. The load characteristics of the spindle therefore need not be considered for the service life calculation.

These values are only theoretical. Consultation with your local contact person at Festo is mandatory for load comparison factors f_v greater than 1.5.

Load comparison factor f_v as a function of service life

Example:

A user wants to move an X kg load. Using the formula $\rightarrow 10$ gives a value of 1.5 for the load comparison factor f_v . According to the graph, the guide would have a service life of

approx. 3 million cycles. Reducing the acceleration reduces the M_z and M_y values. A load comparison factor f_v of 1 now gives a service life of 10 million cycles.



Mini slides EGSL, electric

Technical data

Rotational speed n as a function of feed speed v

EGSL-35

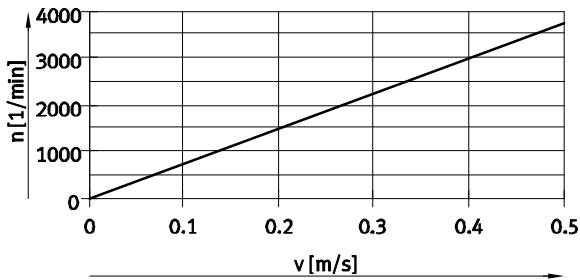

EGSL-BS-35- ... -8P

EGSL-45

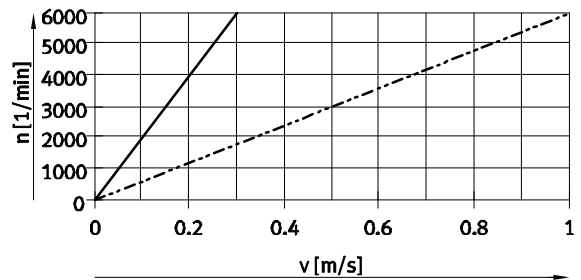

EGSL-BS-45- ... -3P
EGSL-BS-45- ... -10P

EGSL-55

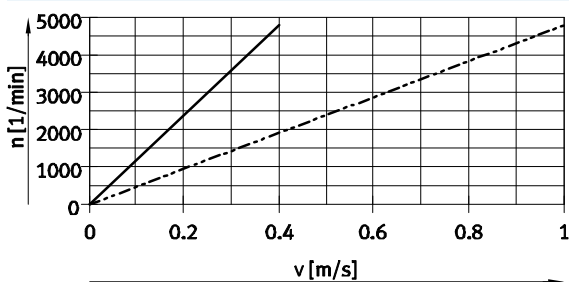

EGSL-BS-55- ... -5P
EGSL-BS-55- ... -12.7P

EGSL-75

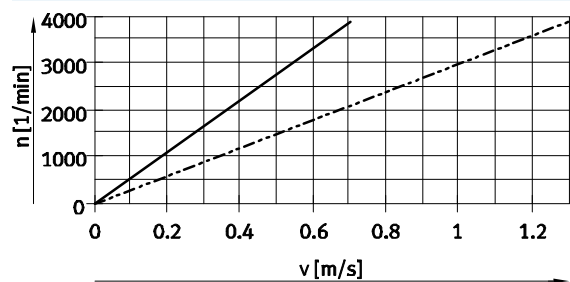

EGSL-BS-75- ... -10P
EGSL-BS-75- ... -20P

Driving torque M as a function of feed force F

EGSL-35

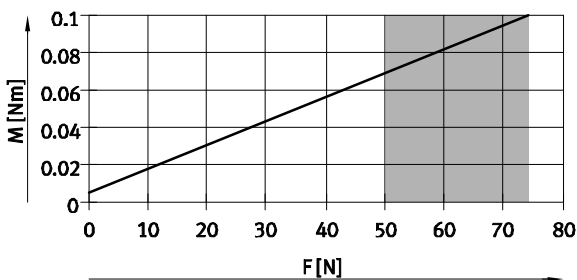

EGSL-BS-35- ... -8P

EGSL-45

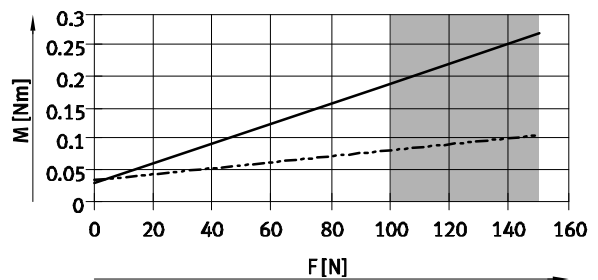

EGSL-BS-45- ... -10P
EGSL-BS-45- ... -3P

EGSL-55

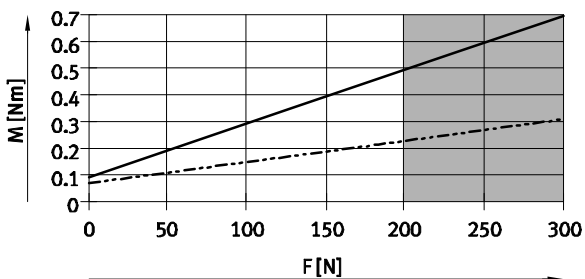

EGSL-BS-55- ... -12.7P
EGSL-BS-55- ... -5P

EGSL-75

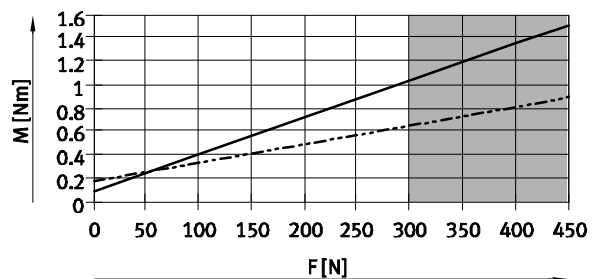

EGSL-BS-75- ... -20P
EGSL-BS-75- ... -10P

This range should be used only briefly.

Mini slides EGSL, electric

Technical data

Deflection x as a function of force Fz and stroke l

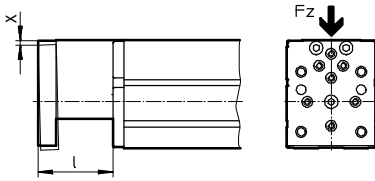

EGSL-35

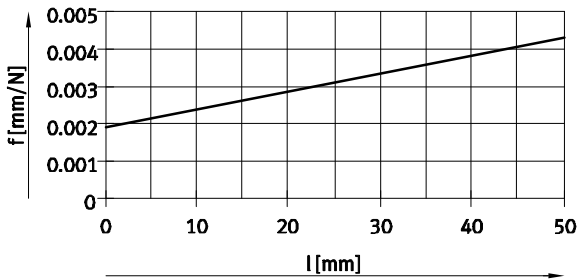

EGSL-BS-35-50

EGSL-45

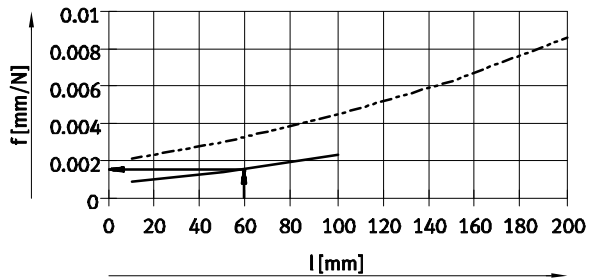

EGSL-BS-45-100

EGSL-BS-45-200

EGSL-55

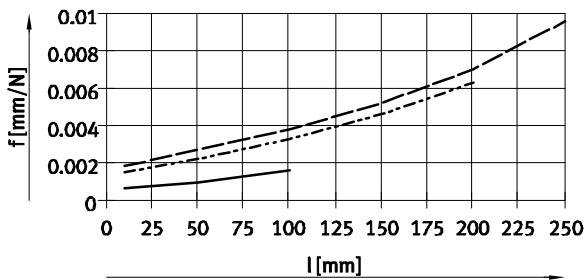

EGSL-BS-55-100

EGSL-BS-55-200

EGSL-BS-55-250

EGSL-75

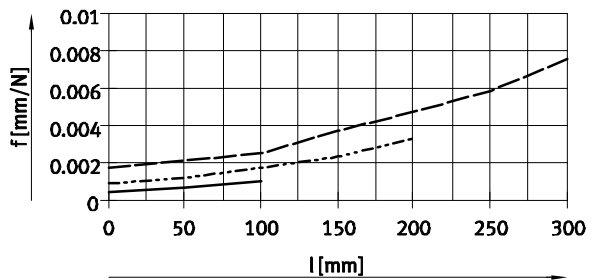

EGSL-BS-75-100

EGSL-BS-75-200

EGSL-BS-75-300

Calculation example

Given:

EGSL-BS-45-100

$l = 60$ mm

$F_z = 30$ N

Mounting position:

Horizontal

Result:

The graph shows a resilience of $f = 0.0015$ mm/N with a stroke of 60 mm.

$$x = f \times F_z$$

$$x = 0.0015 \text{ mm/N} \times 30 \text{ N}$$

$$x = 0.045 \text{ mm}$$

Mini slides EGSL, electric

Technical data

Deflection x as a function of force F_y and stroke l

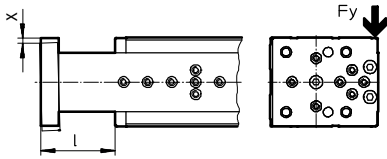

EGSL-35

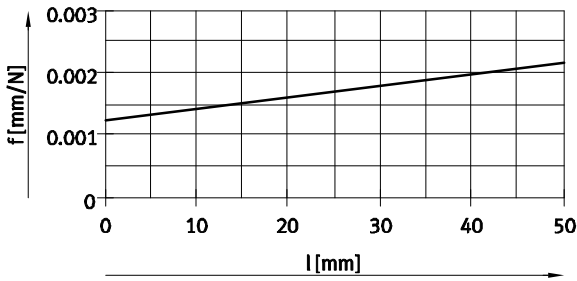

EGSL-BS-35-50

EGSL-45

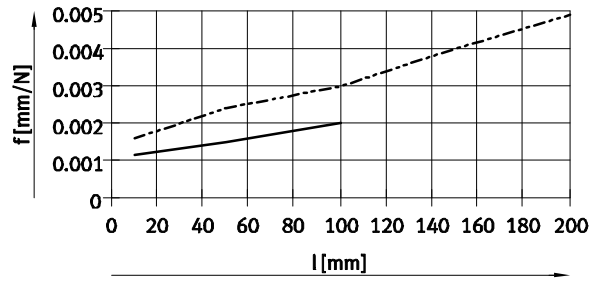

EGSL-BS-45-100

EGSL-BS-45-200

EGSL-55

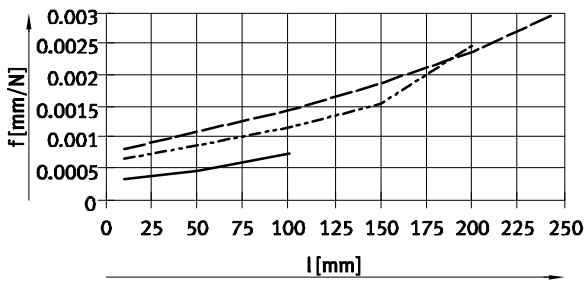

EGSL-BS-55-100

EGSL-BS-55-200

EGSL-BS-55-250

EGSL-75

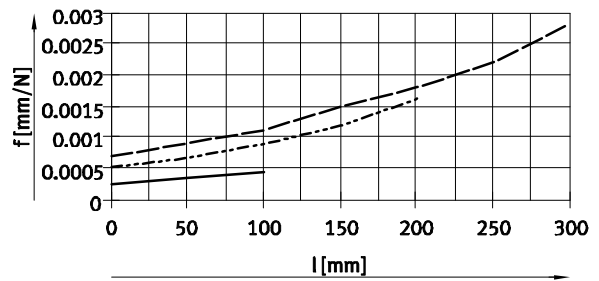

EGSL-BS-75-100

EGSL-BS-75-200

EGSL-BS-75-300

Mini slides EGSL, electric

Technical data

FESTO

Dimensions

Download CAD data → www.festo.com

Size 35

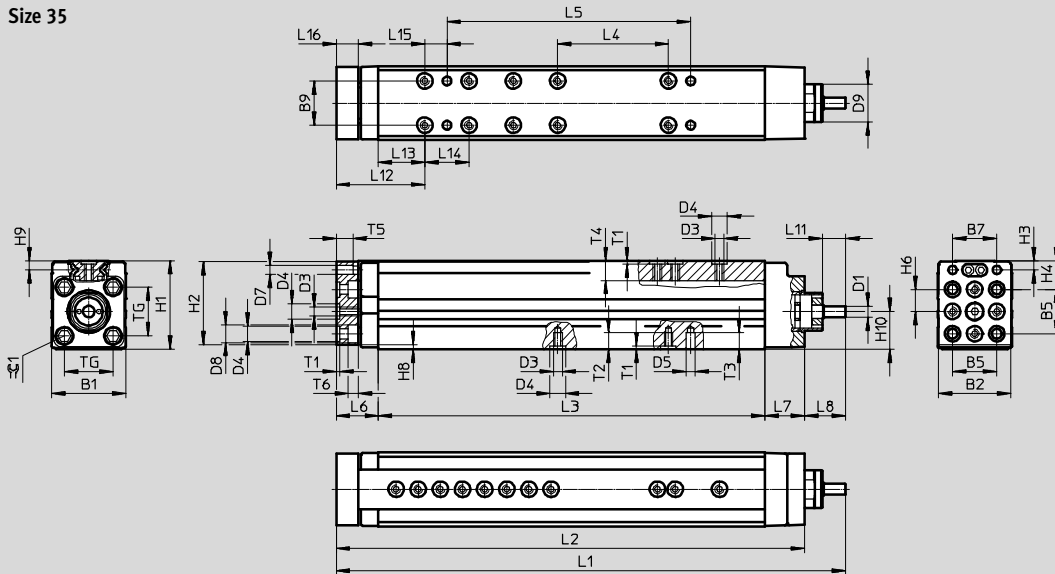

Size 45/55/75

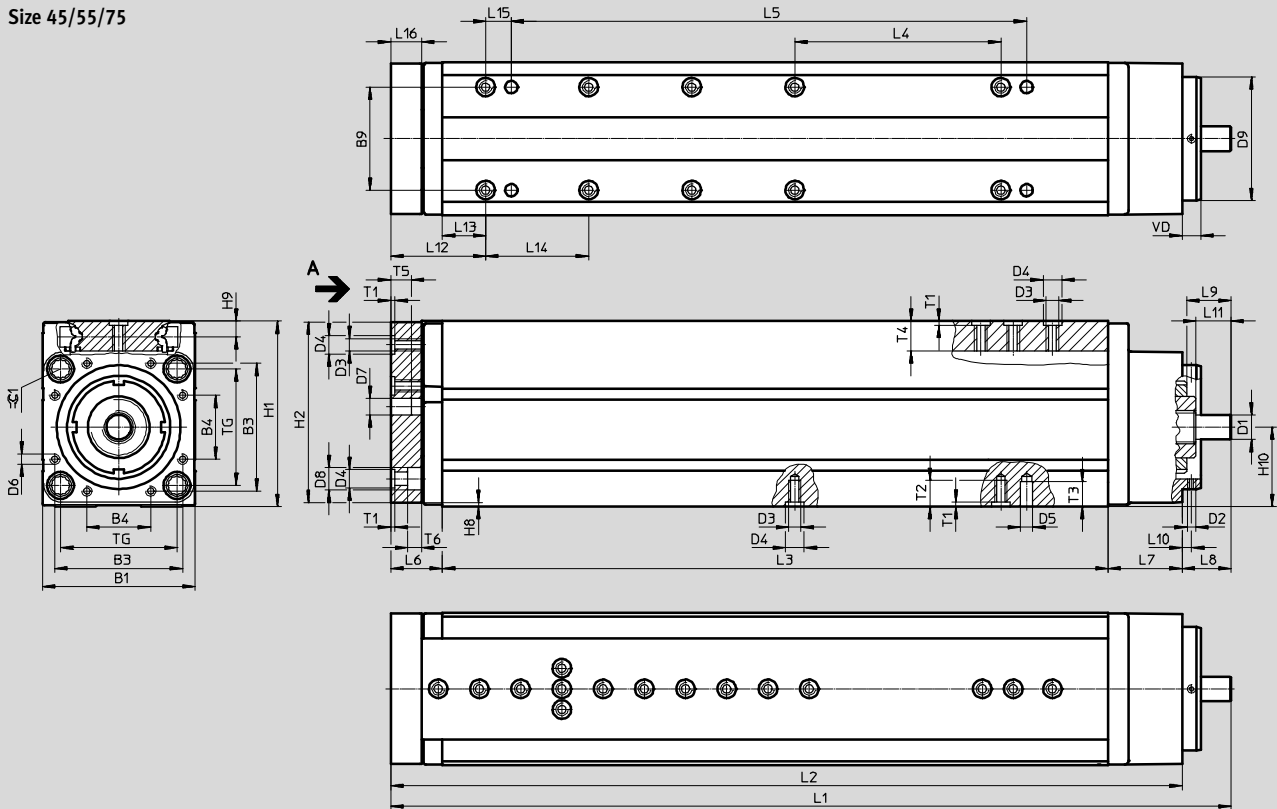

View A

Size 45

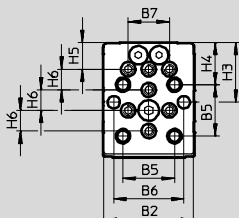

Size 55

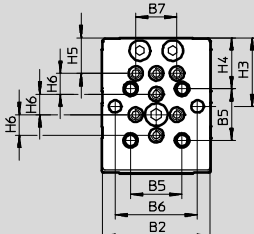

Size 75

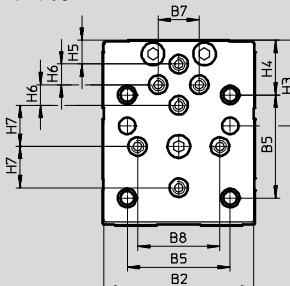

1 Rubber buffers are integrated in the slide and can be removed for homing to the fixed stop.

Mini slides EGSL, electric

Technical data

Size	B1	B2	B3	B4	B5	B6	B7	B8	B9 ±0.5	D1 ∅
35	33.5	33	–	–	20	–	20	–	20	5
45	44.5	43.5	32	19	25	34	20	–	25	6
55	53	52	42	20	25	40	20	–	25	8
75	74	73	62	31	50	–	20	40	50	12

Size	D2	D3	D4 ∅ H7	D5 ∅ H7	D6	D7 ∅	D8 ∅	D9 ∅ g7	H1	H2
35	–	M4	7	4	–	4	8	19	40	37.5
45	M3	M5	7	6	M3	6	10	32	56	53.5
55	M3	M5	7	6	M4	6	10	40	66	63.5
75	M4	M6	9	6	M5	8	11	60	90	87.5

Size	H3	H4	H5	H6	H7	H8	H9	H10	L6	
									2) ±1	3) ±1
35	4.2	13	–	10	–	2	4.2	17+0.09/-0.07	21	19
45	29	20.5	13	10	–	2	6.4	23±0.08	22	20
55	33.3	24.8	17.3	10	–	2	6.4	28.7±0.08	27	25
75	41.5	26.5	11.5	10	20	2	7.6	38.5±0.08	27	25

Size	L7	L8 ±1	L9	L10	L11 ±0.2	L12		L13 ¹⁾	L14 ¹⁾	L15 ±0.1
						2)	3)			
35	18	18.5	–	–	10.5	42	40	21	20	10
45	26	16	16.9	3.5	8	43	41	21	25	12.5
55	30	18.5	14.9	3.5	14	48	46	21	25	12.5
75	36	23.6	21.5	4.5	17	48	46	21	50	12.5

Size	L16	T1 ±0.1	T2	T3	T4	T5	T6	TG	VD	∅ 1
35	10	1.6	7.6	7.5	9	7.5	4.6	22	–	5
45	10	1.6	8.1	7.5	12.4	7.5	5.7	32.5	7	6
55	15	1.6	8.6	8.5	12.4	10	8.7	38	7	6
75	15	2.1	12.6	12	14.5	10	6.8	56.5	9	8

Size	Stroke [mm]	L1		L2		L3 -0.2	L4 ¹⁾	L5 ¹⁾ ±0.05
		2) ±1.5	3) ±1.5	2) ±1	3) ±1			
35	50	182	180	163.5	161.5	124.5	–	60
45	100	248	246	232	230	184	75	125
	200	348	346	332	330	284	100	175
55	100	284.5	282.5	266	264	209	100	150
	200	384.5	382.5	366	364	309	100	175
	250	463.5	461.5	445	443	388	100	175
75	100	309.6	307.6	286	284	223	–	150
	200	409.6	407.6	386	384	323	100	250
	300	514.6	512.6	491	489	428	150	350

1) Tolerance for centring hole ±0.02 mm
Tolerance for thread ±0.1 mm

2) With rubber buffer

3) Without rubber buffer: for homing to the fixed stop

Mini slides EGSL, electric

Technical data

Hole pattern for mounting threads and centring holes

EGSL-35-50

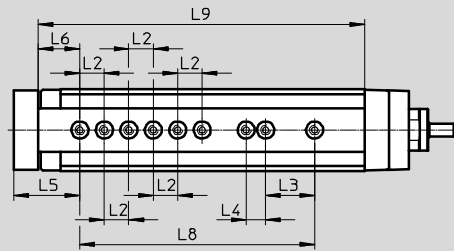

EGSL-45-100

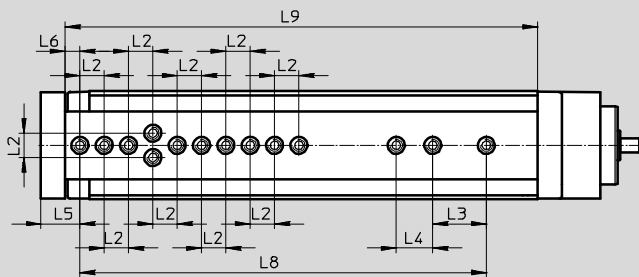

EGSL-45-200

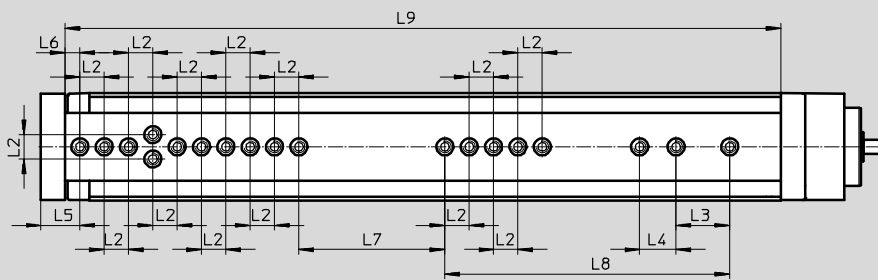

Size	Stroke [mm]	L2 ¹⁾	L3 ¹⁾	L4 ¹⁾	L5	L6	L7 ¹⁾	L8 ¹⁾	L9
35	50	10	20	8	27	17	-	96	133.5
45	100	10	22	15	16	6	-	167	194
	200						60	117	294

1) Tolerance for centring hole ± 0.02 mm
Tolerance for thread ± 0.1 mm

Mini slides EGSL, electric

Technical data

Hole pattern for mounting threads and centring holes

EGSL-55-100

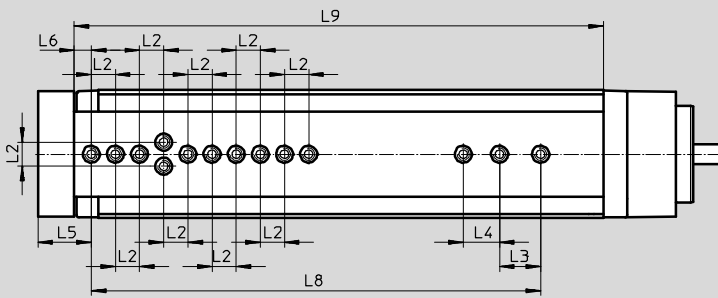

EGSL-55-200

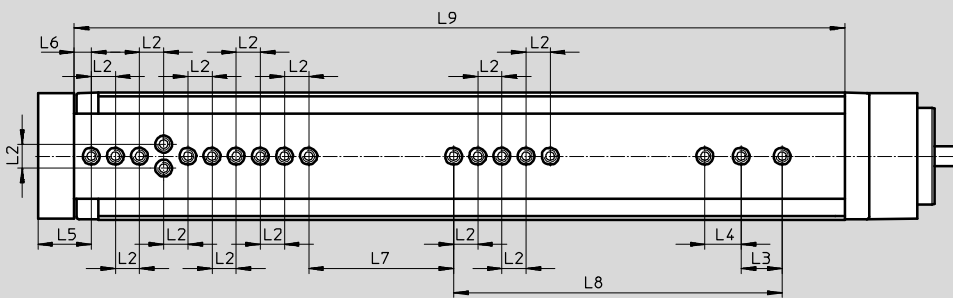

EGSL-55-250

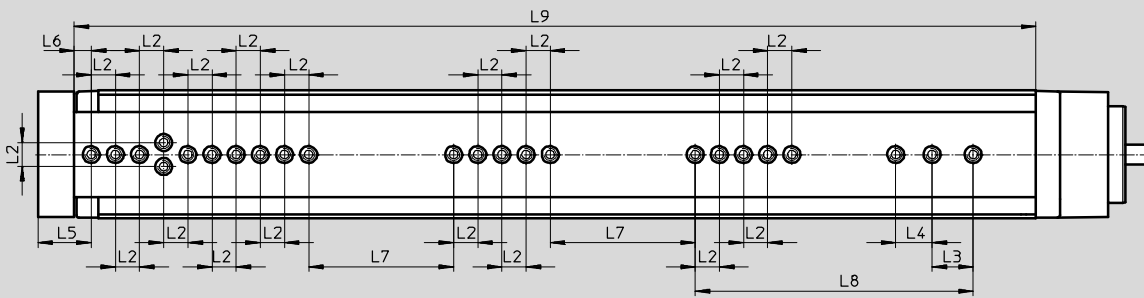

Size	Stroke [mm]	L2 ¹⁾	L3 ¹⁾	L4 ¹⁾	L5	L6	L7 ¹⁾	L8 ¹⁾	L9
55	100	10	17	15	22	7	-	186	219
	200						60	136	319
	250						60	115	398

1) Tolerance for centring hole ± 0.02 mm
Tolerance for thread ± 0.1 mm

Mini slides EGSL, electric

Technical data



Hole pattern for mounting threads and centring holes

EGSL-75-100

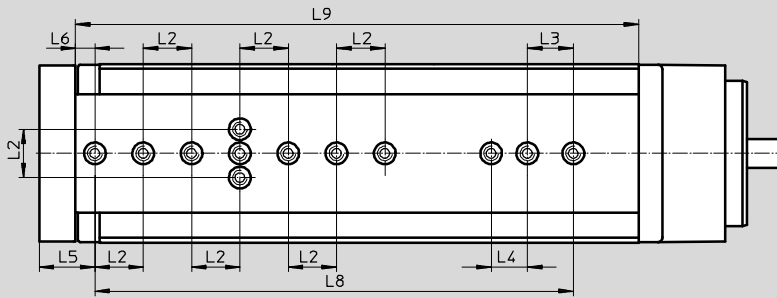

EGSL-75-200

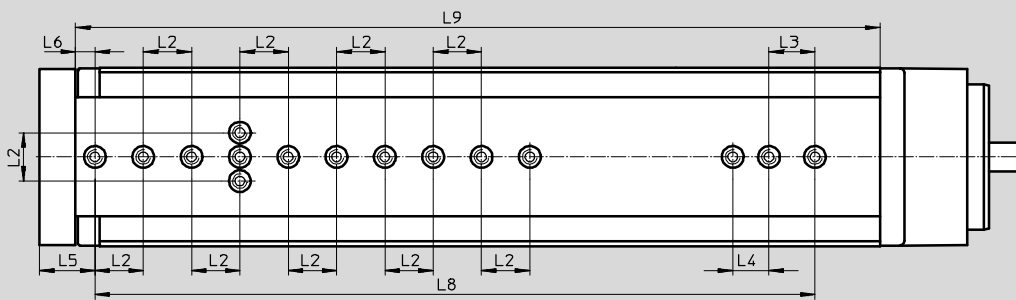

EGSL-75-300

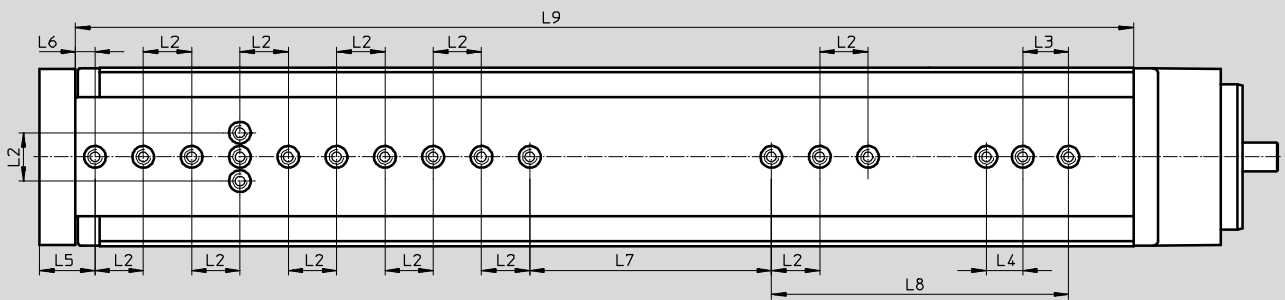

Size	Stroke [mm]	L2 ¹⁾	L3 ¹⁾	L4 ¹⁾	L5	L6	L7 ¹⁾	L8 ¹⁾	L9
75	100	20	19	15	23	8	-	198	233
	200						-	298	333
	300						100	123	438

1) Tolerance for centring hole ± 0.02 mm
Tolerance for thread ± 0.1 mm

Mini slides EGSL, electric

Technical data

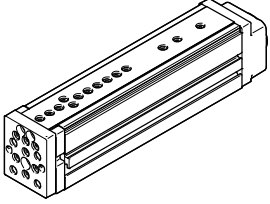
Ordering data					
	Size	Spindle pitch	Stroke	Part No.	Type
	35	8	50	562160	EGSL-BS-35-50-8P
	45	3	100	562225	EGSL-BS-45-100-3P
			200	562226	EGSL-BS-45-200-3P
		10	100	559335	EGSL-BS-45-100-10P
			200	559336	EGSL-BS-45-200-10P
	55	5	100	562227	EGSL-BS-55-100-5P
			200	562228	EGSL-BS-55-200-5P
			250	562229	EGSL-BS-55-250-5P
		12.7	100	559337	EGSL-BS-55-100-12.7P
			200	559338	EGSL-BS-55-200-12.7P
			250	559339	EGSL-BS-55-250-12.7P
	75	10	100	562230	EGSL-BS-75-100-10P
			200	562231	EGSL-BS-75-200-10P
			300	562232	EGSL-BS-75-300-10P
		20	100	559340	EGSL-BS-75-100-20P
			200	559341	EGSL-BS-75-200-20P
300			559342	EGSL-BS-75-300-20P	

Mini slides EGSL, electric

Accessories



FESTO



Note

Depending on the combination of motor and drive, it may not be possible to reach the maximum feed force of the drive.

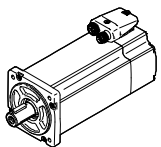
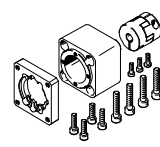
The respective no-load driving torque of the kit must be taken into consideration when using parallel kits.

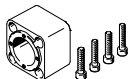

Permissible axis/motor combinations with axial kit – Without gear unit					Technical data → Internet: eamm-a
Motor ¹⁾	Axial kit	Axial kit consisting of:			
		Motor flange	Coupling	Coupling housing	
					
Type	Part No. Type	Part No. Type	Part No. Type	Part No. Type	
EGSL-35					
With servo motor					
EMME-AS-40-...	1981953 EAMM-A-D19-40P	1982014 EAMF-A-28D-40P	562677 EAMC-16-20-5-8	1087585 EAMK-A-D19-28D	
EMMS-AS-40-...	1199152 EAMM-A-D19-40A	1199144 EAMF-A-28D-40A	543419 EAMC-16-20-5-6	1087585 EAMK-A-D19-28D	
With stepper motor					
EMMS-ST-28-...	1081659 EAMM-A-D19-28A	1087613 EAMF-A-28D-28A	562676 EAMC-16-20-5-5	1087585 EAMK-A-D19-28D	
EMMS-ST-42-...	1087642 EAMM-A-D19-42A	1087630 EAMF-A-28D-42A	562676 EAMC-16-20-5-5	1087585 EAMK-A-D19-28D	
EGSL-45					
With servo motor					
EMME-AS-40-...	1976465 EAMM-A-D32-40P	1976704 EAMF-A-28B-40P	1232854 EAMC-16-20-6-8	552155 EAMK-A-D32-28B	
EMMS-AS-40-...	543147 EAMM-A-D32-40A	552163 EAMF-A-28B-40A	543420 EAMC-16-20-6-6	552155 EAMK-A-D32-28B	
EMMS-AS-55-...	550979 EAMM-A-D32-55A	529942 EAMF-A-44A/B-55A	551003 EAMC-30-32-6-9	551006 EAMK-A-D32-44A/C	
EMME-AS-60-...	1956054 EAMM-A-D32-60P	1956846 EAMF-A-44C-60P	1233256 EAMC-30-32-6-14	551006 EAMK-A-D32-44A/C	
With stepper motor					
EMMS-ST-42-...	543148 EAMM-A-D32-42A	552164 EAMF-A-28B-42A	543419 EAMC-16-20-5-6	552155 EAMK-A-D32-28B	
EMMS-ST-57-...	550980 EAMM-A-D32-57A	530081 EAMF-A-44A/B-57A	551002 EAMC-30-32-6-6.35	551006 EAMK-A-D32-44A/C	
With integrated drive					
EMCA-EC-67-...	1454239 EAMM-A-D32-67A	1476305 EAMF-A-44A/B/C-67A-S1	551003 EAMC-30-32-6-9	551006 EAMK-A-D32-44A/C	
With motor unit					
MTR-DCI-32S-...	543149 EAMM-A-D32-32B	–	543420 EAMC-16-20-6-6	552156 EAMK-A-D32-32B	

1) The input torque must not exceed the maximum permissible transferable torque of the axial kit.

Mini slides EGSL, electric

Accessories

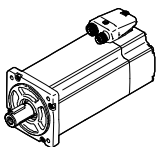
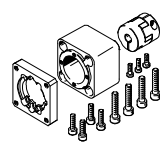
FESTO

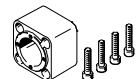
Permissible axis/motor combinations with axial kit – Without gear unit				Technical data → Internet: eamm-a
Motor ¹⁾	Axial kit	Axial kit consisting of:		
		Motor flange	Coupling	Coupling housing
				
Type	Part No. Type	Part No. Type	Part No. Type	Part No. Type
EGSL-55				
With servo motor				
EMMS-AS-55-...	543153 EAMM-A-D40-55A	529942 EAMF-A-44A/B-55A	543423 EAMC-30-32-8-9	552157 EAMK-A-D40-44A/C
EMME-AS-60-...	1977000 EAMM-A-D40-60P	1956846 EAMF-A-44C-60P	562682 EAMC-30-32-8-14	552157 EAMK-A-D40-44A/C
EMMS-AS-70-...	550981 EAMM-A-D40-70A	529943 EAMF-A-44A/B-70A	551004 EAMC-30-32-8-11	552157 EAMK-A-D40-44A/C
With stepper motor				
EMMS-ST-57-...	543154 EAMM-A-D40-57A	530081 EAMF-A-44A/B-57A	543421 EAMC-30-32-6.35-8	552157 EAMK-A-D40-44A/C
EMMS-ST-87-...	550982 EAMM-A-D40-87A	530082 EAMF-A-44A/B-87A	551004 EAMC-30-32-8-11	552157 EAMK-A-D40-44A/C
With integrated drive				
EMCA-EC-67-...	1454243 EAMM-A-D40-67A	1476305 EAMF-A-44A/B/C-67A-S1	543423 EAMC-30-32-8-9	552157 EAMK-A-D40-44A/C
With motor unit				
MTR-DCI-42S-...-G7	543155 EAMM-A-D40-42B	–	543422 EAMC-30-32-8-8	552158 EAMK-A-D40-42B
MTR-DCI-42S-...-G14	543156 EAMM-A-D40-42C	–	543422 EAMC-30-32-8-8	552159 EAMK-A-D40-42C
EGSL-75				
With servo motor				
EMMS-AS-70-...	543161 EAMM-A-D60-70A	529945 EAMF-A-64A/B-70A	543424 EAMC-42-50-11-12	552160 EAMK-A-D60-64B
EMME-AS-80-...	1977073 EAMM-A-D60-80P	1977113 EAMF-A-64A/C-80P	551005 EAMC-42-50-12-19	551007 EAMK-A-D60-64C
EMME-AS-100-...	550983 EAMM-A-D60-100A	529947 EAMF-A-64A/C/D-100A	551005 EAMC-42-50-12-19	551007 EAMK-A-D60-64C
EMMS-AS-100-...	550983 EAMM-A-D60-100A	529947 EAMF-A-64A/C/D-100A	551005 EAMC-42-50-12-19	551007 EAMK-A-D60-64C
With stepper motor				
EMMS-ST-87-...	543162 EAMM-A-D60-87A	533140 EAMF-A-64A/B-87A	543424 EAMC-42-50-11-12	552160 EAMK-A-D60-64B
With motor unit				
MTR-DCI-52S-...-G7	543163 EAMM-A-D60-52B	–	533709 EAMC-42-50-12-12	552161 EAMK-A-D60-52B
MTR-DCI-52S-...-G14	543164 EAMM-A-D60-52C	–	533709 EAMC-42-50-12-12	552162 EAMK-A-D60-52C

1) The input torque must not exceed the maximum permissible transferable torque of the axial kit.

Mini slides EGSL, electric

Accessories

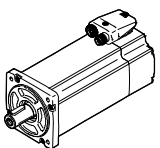
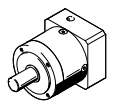
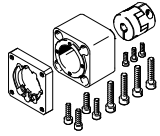
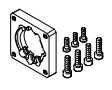
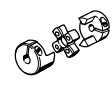
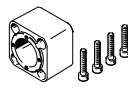

Permissible axis/motor combinations with axial kit – With gear unit						Technical data → Internet: eamm-a
Motor ¹⁾	Gear unit	Axial kit	Axial kit consisting of:			
			Motor flange	Coupling	Coupling housing	
						
Type	Type	Part No. Type	Part No. Type	Part No. Type	Part No. Type	
EGSL-45						
With servo motor						
EMME-AS-40-...	EMGA-40-P-G...-EAS-40	1454238 EAMM-A-D32-40G	1460095 EAMF-A-44C-40G-S1	562681 EAMC-30-32-6-10	551006 EAMK-A-D32-44A/C	
EMMS-AS-40-...	EMGA-40-P-G...-SAS-40	1454238 EAMM-A-D32-40G	1460095 EAMF-A-44C-40G-S1	562681 EAMC-30-32-6-10	551006 EAMK-A-D32-44A/C	
EMMS-AS-55-...	EMGA-60-P-G...-SAS-55	2946758 EAMM-A-D32-60G	1460105 EAMF-A-44C-60G/H-S1	3187577 EAMC-30-32-6-11	551006 EAMK-A-D32-44A/C	
EMME-AS-60-...	EMGA-60-P-G...-EAS-60	2946760 EAMM-A-D32-60H	1460105 EAMF-A-44C-60G/H-S1	1233256 EAMC-30-32-6-14	551006 EAMK-A-D32-44A/C	
EMMS-AS-70-...	EMGA-60-P-G...-SAS-70	2946758 EAMM-A-D32-60G	1460105 EAMF-A-44C-60G/H-S1	3187577 EAMC-30-32-6-11	551006 EAMK-A-D32-44A/C	
With stepper motor						
EMMS-ST-42-...	EMGA-40-P-G...-SST-42	1454238 EAMM-A-D32-40G	1460095 EAMF-A-44C-40G-S1	562681 EAMC-30-32-6-10	551006 EAMK-A-D32-44A/C	
EMMS-ST-57-...	EMGA-60-P-G...-SST-57	2946758 EAMM-A-D32-60G	1460105 EAMF-A-44C-60G/H-S1	3187577 EAMC-30-32-6-11	551006 EAMK-A-D32-44A/C	
With integrated drive						
EMCA-EC-67-...	EMGC-40-...	1454238 EAMM-A-D32-40G	1460095 EAMF-A-44C-40G-S1	562681 EAMC-30-32-6-10	551006 EAMK-A-D32-44A/C	
	EMGC-60-...	2946760 EAMM-A-D32-60H	1460105 EAMF-A-44C-60G/H-S1	1233256 EAMC-30-32-6-14	551006 EAMK-A-D32-44A/C	
EGSL-55						
With servo motor						
EMME-AS-40-...	EMGA-40-P-G...-EAS-40	560282 EAMM-A-D40-40G ²⁾	550986 EAMF-A-44A/B-40G	558029 EAMC-30-32-8-10	552157 EAMK-A-D40-44A/C	
		2256398 EAMM-A-D40-40G-G2	1460095 EAMF-A-44C-40G-S1	558029 EAMC-30-32-8-10	552157 EAMK-A-D40-44A/C	
EMMS-AS-40-...	EMGA-40-P-G...-SAS-40	560282 EAMM-A-D40-40G ²⁾	550986 EAMF-A-44A/B-40G	558029 EAMC-30-32-8-10	552157 EAMK-A-D40-44A/C	
		2256398 EAMM-A-D40-40G-G2	1460095 EAMF-A-44C-40G-S1	558029 EAMC-30-32-8-10	552157 EAMK-A-D40-44A/C	
EMMS-AS-55-...	EMGA-60-P-G...-SAS-55	2256400 EAMM-A-D40-60G	1460105 EAMF-A-44C-60G/H-S1	551004 EAMC-30-32-8-11	552157 EAMK-A-D40-44A/C	
EMME-AS-60-...	EMGA-60-P-G...-EAS-60	1454242 EAMM-A-D40-60H	1460105 EAMF-A-44C-60G/H-S1	562682 EAMC-30-32-8-14	552157 EAMK-A-D40-44A/C	
EMMS-AS-70-...	EMGA-60-P-G...-SAS-70	2256400 EAMM-A-D40-60G	1460105 EAMF-A-44C-60G/H-S1	551004 EAMC-30-32-8-11	552157 EAMK-A-D40-44A/C	
With stepper motor						
EMMS-ST-42-...	EMGA-40-P-G...-SST-42	560282 EAMM-A-D40-40G ²⁾	550986 EAMF-A-44A/B-40G	558029 EAMC-30-32-8-10	552157 EAMK-A-D40-44A/C	
		2256398 EAMM-A-D40-40G-G2	1460095 EAMF-A-44C-40G-S1	558029 EAMC-30-32-8-10	552157 EAMK-A-D40-44A/C	
EMMS-ST-57-...	EMGA-60-P-G...-SST-57	2256400 EAMM-A-D40-60G	1460105 EAMF-A-44C-60G/H-S1	551004 EAMC-30-32-8-11	552157 EAMK-A-D40-44A/C	



1) The input torque must not exceed the maximum permissible transferable torque of the axial kit.

2) Type discontinued

Mini slides EGSL, electric

Accessories

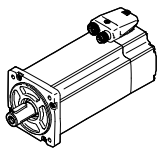
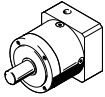
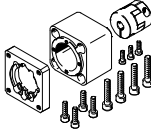
FESTO

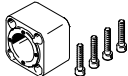
Permissible axis/motor combinations with axial kit – With gear unit						Technical data → Internet: eamm-a
Motor ¹⁾	Gear unit	Axial kit	Axial kit consisting of:			
			Motor flange	Coupling	Coupling housing	
						
Type	Type	Part No. Type	Part No. Type	Part No. Type	Part No. Type	
EGSL-55						
With integrated drive						
EMCA-EC-67-...	EMGC-40-...	560282 EAMM-A-D40-40G ²⁾	550986 EAMF-A-44A/B-40G	558029 EAMC-30-32-8-10	552157 EAMK-A-D40-44A/C	
		2256398 EAMM-A-D40-40G-G2	1460095 EAMF-A-44C-40G-S1	558029 EAMC-30-32-8-10	552157 EAMK-A-D40-44A/C	
	EMGC-60-...	1454242 EAMM-A-D40-60H	1460105 EAMF-A-44C-60G/H-S1	562682 EAMC-30-32-8-14	552157 EAMK-A-D40-44A/C	
EGSL-75						
With servo motor						
EMMS-AS-55-...	EMGA-60-P-G...-SAS-55	560283 EAMM-A-D60-60G ²⁾	550987 EAMF-A-64A/B-60G/H	543424 EAMC-42-50-11-12	552160 EAMK-A-D60-64B	
		2256696 EAMM-A-D60-60G-G2	2256289 EAMF-A-64B-60G/H-S1	543424 EAMC-42-50-11-12	552160 EAMK-A-D60-64B	
EMME-AS-60-...	EMGA-60-P-G...-EAS-60	1454245 EAMM-A-D60-60H	2256289 EAMF-A-64B-60G/H-S1	1455671 EAMC-42-50-12-14	552160 EAMK-A-D60-64B	
EMMS-AS-70-...	EMGA-60-P-G...-SAS-70	560283 EAMM-A-D60-60G	550987 EAMF-A-64A/B-60G/H	543424 EAMC-42-50-11-12	552160 EAMK-A-D60-64B	
EMMS-AS-70-...	EMGA-80-P-G...-SAS-70	1499402 EAMM-A-D60-80G	2843290 EAMF-A-64C-80G-S1	2138701 EAMC-42-50-12-20	551007 EAMK-A-D60-64C	
EMME-AS-80-...	EMGA-80-P-G...-EAS-80	1499402 EAMM-A-D60-80G	2843290 EAMF-A-64C-80G-S1	2138701 EAMC-42-50-12-20	551007 EAMK-A-D60-64C	
EMME-AS-100-...	EMGA-80-P-G...-SAS-100	1499402 EAMM-A-D60-80G	2843290 EAMF-A-64C-80G-S1	2138701 EAMC-42-50-12-20	551007 EAMK-A-D60-64C	
EMMS-AS-100-...	EMGA-80-P-G...-SAS-100	1499402 EAMM-A-D60-80G	2843290 EAMF-A-64C-80G-S1	2138701 EAMC-42-50-12-20	551007 EAMK-A-D60-64C	
With stepper motor						
EMMS-ST-57-...	EMGA-60-P-G...-SST-57	560283 EAMM-A-D60-60G ²⁾	550987 EAMF-A-64A/B-60G/H	543424 EAMC-42-50-11-12	552160 EAMK-A-D60-64B	
		2256696 EAMM-A-D60-60G-G2	2256289 EAMF-A-64B-60G/H-S1	543424 EAMC-42-50-11-12	552160 EAMK-A-D60-64B	
EMMS-ST-87-...	EMGA-80-P-G...-SST-87	1499402 EAMM-A-D60-80G	2843290 EAMF-A-64C-80G-S1	2138701 EAMC-42-50-12-20	551007 EAMK-A-D60-64C	
With integrated drive						
EMCA-EC-67-...	EMGC-60-...	1454245 EAMM-A-D60-60H	2256289 EAMF-A-64B-60G/H-S1	1455671 EAMC-42-50-12-14	552160 EAMK-A-D60-64B	

1) The input torque must not exceed the maximum permissible transferable torque of the axial kit.
2) Type discontinued

Mini slides EGSL, electric

Accessories

FESTO

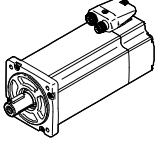
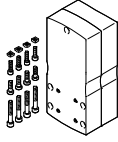
Permissible axis/motor combinations with parallel kit		Technical data → Internet: eamm-u
Motor ¹⁾	Parallel kit	
		<ul style="list-style-type: none"> • Increased housing rigidity • More flexible motor connection possible • Optionally with protection to IP65 • Components can be mounted to the kit facing any direction • Use in combination with third-party motors on request
Type	Part No.	Type
EGSL-45		
With servo motor		
EMME-AS-40-...	2153283	EAMM-U-50-D32-40P-78
EMMS-AS-40-...	1201591	EAMM-U-50-D32-40A-78
EMMS-AS-55-...	1210126	EAMM-U-60-D32-55A-91
EMME-AS-60-...	2619586	EAMM-U-70-D32-60P-96
With stepper motor		
EMMS-ST-42-...	1201607	EAMM-U-50-D32-42A-78
EMMS-ST-57-...	1210419	EAMM-U-60-D32-57A-91
With motor		
MTR-DCI-32S-...	1570862	EAMM-U-50-D32-32B-78
MTR-DCI-42S-...	1577393	EAMM-U-60-D32-42B/C-91
With gear unit		
EMGA-40-P-...	1577358	EAMM-U-60-D32-40G-91
EMGC-40-P-...	1577358	EAMM-U-60-D32-40G-91
EMGA-60-P-...-SAS/SST²⁾	2748181	EAMM-U-70-D32-60G-96
EMGA-60-P-...-EAS, EMGC-60-P-...²⁾	2778393	EAMM-U-70-D32-60H-96



1) The output torque at the gear unit output must be less than the transferable torque of the kit.

2) Gear unit drive shaft diameter: EMGA-60-P-...-SAS/-SST11 mm; EMGA-60-P-...-EAS, EMGC-60-P14 mm

Mini slides EGSL, electric

Accessories

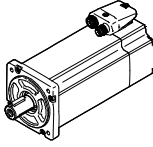
FESTO

Permissible axis/motor combinations with parallel kit		Technical data → Internet: eamm-u
Motor/motor unit ¹⁾	Parallel kit	
		<ul style="list-style-type: none"> • Increased housing rigidity • More flexible motor connection possible • Optionally with protection to IP65 • Components can be mounted to the kit facing any direction • Use in combination with third-party motors on request
Type	Part No.	Type
EGSL-55		
With servo motor		
EMMS-AS-55-...	1210438	EAMM-U-60-D40-55A-91
EMMS-AS-70-...	1212826	EAMM-U-86-D40-70A-102
EMMS-AS-70-...	2786204	EAMM-U-70-D40-70A-96
EMMS-AS-70-...	1212826	EAMM-U-86-D40-70A-102
With stepper motor		
EMMS-ST-57-...	1210442	EAMM-U-60-D40-57A-91
EMMS-ST-87-...	1215802	EAMM-U-86-D40-87A-102
With motor		
MTR-DCI-42S-...	1570950	EAMM-U-60-D40-42B/C-91
MTR-DCI-52S-...	2786802	EAMM-U-70-D40-52B/C-96
MTR-DCI-52S-...	1537046	EAMM-U-86-D40-52B/C-102
With gear unit		
EMGA-40-P-...	1577165	EAMM-U-60-D40-40G-91
EMGC-40-P-...	1577165	EAMM-U-60-D40-40G-91
EMGA-60-P-...-SAS/SST ²⁾	2785471	EAMM-U-70-D40-60G-96
EMGA-60-P-...-EAS, EMGC-60-P-... ²⁾	2786101	EAMM-U-70-D40-60H-96
EMGA-60-P-...-SAS/SST ²⁾	1586445	EAMM-U-86-D40-60G-102
EMGA-60-P-...-EAS, EMGC-60-P-... ²⁾	1586496	EAMM-U-86-D40-60H-102
EGSL-75		
With servo motor		
EMMS-AS-70-...	1212477	EAMM-U-86-D60-70A-102
EMME-AS-80-...	2155875	EAMM-U-86-D60-80P-102
With stepper motor		
EMMS-ST-87-...	1215784	EAMM-U-86-D60-87A-102
With motor		
MTR-DCI-52S-...	1537000	EAMM-U-86-D60-52B/C-102
MTR-DCI-62S-...	1536988	EAMM-U-110-D60-62B-120
With gear unit		
EMGA-60-P-...-SAS/SST ²⁾	1586347	EAMM-U-86-D60-60G-102
EMGA-60-P-...-EAS, EMGC-60-P-... ²⁾	1586276	EAMM-U-86-D60-60H-102
EMGA-60-P-...-SAS/SST ²⁾	1543240	EAMM-U-110-D60-60G-120
EMGA-60-P-...-EAS, EMGC-60-P-... ²⁾	1542264	EAMM-U-110-D60-60H-120
EMGA-80-P-...	1532949	EAMM-U-110-D60-80G-120

1) The output torque at the gear unit output must be less than the transferable torque of the kit.

2) Gear unit drive shaft diameter: EMGA-60-P-...-SAS/SST11 mm; EMGA-60-P-...-EAS, EMGC-60-P14 mm

 Note

The clamping component EADT is required to adjust the toothed belt pretension with EAMM-U-110.

The motor and/or axis shaft can optionally be supported with a counter bearing EAMG.

Mini slides EGSL, electric

Accessories



Profile mounting

EAHF/MUE

Material:

Anodised aluminium

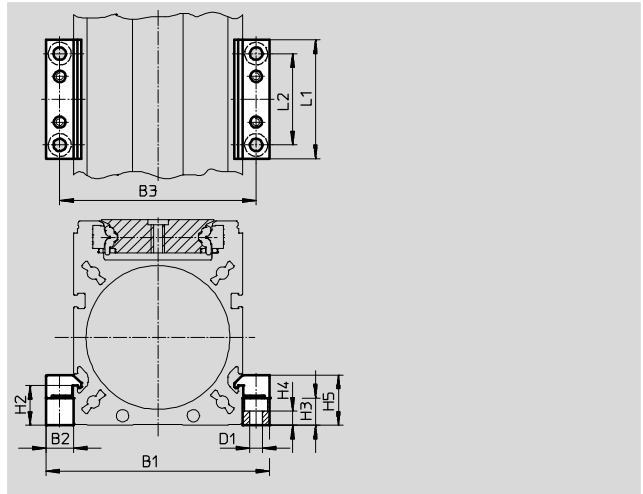
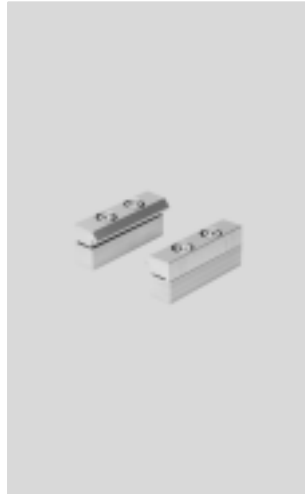

Dimensions and ordering data						
For size	B1	B2	B3	D1 ∅	H2	H3
35	49.5	8	41.5	3.4	10.5	10
45	68.5	12	56.5	5.5	12.5	8.3
55	77	12	65	5.5	17.5	12
75	98	12	86	5.5	17.5	12

For size	H4	H5	L1	L2	Weight [g]	Part No.	Type
35	6.8	15.5	40	20	20	1170211	EAHF-G1-35-P
45	2.5	17	52	40	23	1168859	EAHF-G1-45-P
55	6.2	22	52	40	80	558043	MUE-70/80
75	6.2	22	52	40	80	558043	MUE-70/80

Switch lug EAPM

Material:

Galvanised steel

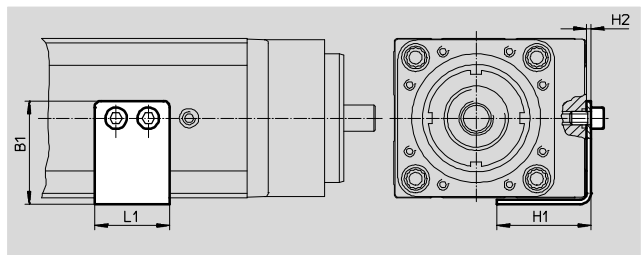

Dimensions and ordering data							
For size	B1	H1	H2	L1	Weight [g]	Part No.	Type
35	25.5	25	1.5	17	15	1235029	EAPM-G1-35-SLS
45	32	32.5	2	30	30	1235033	EAPM-G1-45-SLS
55	36	35	2	30	35	1235035	EAPM-G1-55-SLS
75	48	44	2	35	50	1235036	EAPM-G1-75-SLS

- - Note
The switch lug should only be attached to the designated threads (guide rail at the back).

Mini slides EGSL, electric

Accessories



Cover EASC

Material:
Anodised aluminium
Free of copper and PTFE

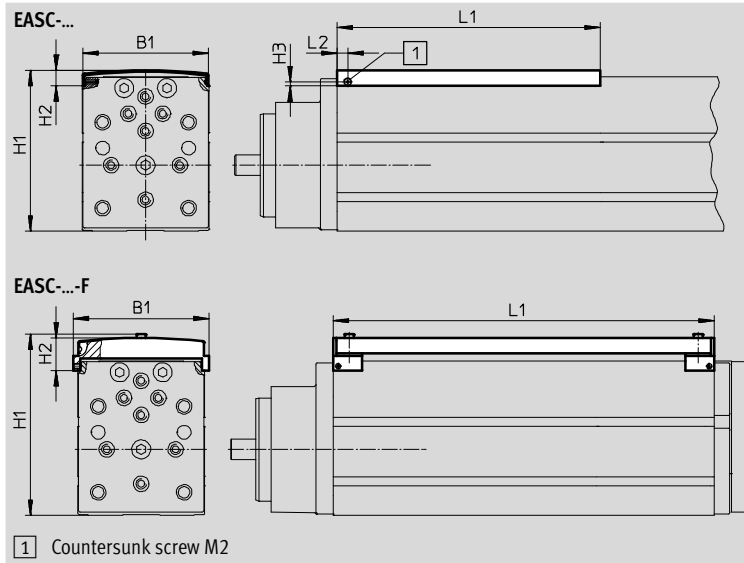

Dimensions and ordering data									
For size	Length [mm]	B1	H1	H2	H3	L1 -0.5	L2 -0.3	Part No.	Type
For use without switch lug									
35	50	32.5	43.2	8.5	2.3	58	6	570819	EASC-G1-35-50
	500 ¹⁾					500		570874	EASC-G1-35-500
45	100	43.5	59.7	9	2.3	108	6	570822	EASC-G1-45-100
	200					208		570823	EASC-G1-45-200
	500 ¹⁾					500		570875	EASC-G1-45-500
55	100	52	69.7	9	2.3	108	6	570824	EASC-G1-55-100
	200					208		570825	EASC-G1-55-200
	250					258		570826	EASC-G1-55-250
	500 ¹⁾					500		570876	EASC-G1-55-500
75	100	73	93.7	9	2.3	108	6	570827	EASC-G1-75-100
	200					208		570828	EASC-G1-75-200
	300					308		570829	EASC-G1-75-300
	500 ¹⁾					500		570877	EASC-G1-75-500
For use with switch lug									
35	50	38.3	55	19.1	-	119.5	-	570830	EASC-G1-35-50-F
45	100	49.7	71.5	19.6	-	179	-	570833	EASC-G1-45-100-F
	200					279		570834	EASC-G1-45-200-F
55	100	58.2	81.5	19.6	-	204	-	570835	EASC-G1-55-100-F
	200					304		570836	EASC-G1-55-200-F
	250					383		570837	EASC-G1-55-250-F
75	100	78.9	105.5	19.4	-	218	-	570838	EASC-G1-75-100-F
	200					318		570839	EASC-G1-75-200-F
	300					423		570840	EASC-G1-75-300-F



Note
For covers with a length of 500 mm, the customer must bore the mounting hole on the side.

1) The cover can be shortened by the customer as required.

Mini slides EGSL, electric

Accessories

FESTO



Ordering data					
	For size	Brief description	Part No.	Type	PU ¹⁾
Centring sleeve ZBH²⁾					
	35, 45, 55	For slide and yoke plate	186717	ZBH-7	10
	75		150927	ZBH-9	
Connecting sleeve ZBV					
	45, 55	For connecting mini slide EGSL with mini slide DGSL	548803	ZBV-M5-7	3
	75		548804	ZBV-M6-9	

1) Packaging unit

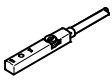
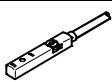
2) The scope of delivery of the mini slide includes six centring sleeves)

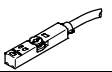
Ordering data – Proximity sensors for T-slot, inductive					Technical data → Internet: sies	
	Type of mounting	Switching output	Electrical connection	Cable length [m]	Part No.	Type
N/O contact						
	Insertable in the slot from above, flush with the cylinder profile	PNP	Cable, 3-wire	7.5	551386	SIES-8M-PS-24V-K-7,5-OE
			Plug M8x1, 3-pin	0.3	551387	SIES-8M-PS-24V-K-0,3-M8D
		NPN	Cable, 3-wire	7.5	551396	SIES-8M-NS-24V-K-7,5-OE
			Plug M8x1, 3-pin	0.3	551397	SIES-8M-NS-24V-K-0,3-M8D
N/C contact						
	Insertable in the slot from above, flush with the cylinder profile	PNP	Cable, 3-wire	7.5	551391	SIES-8M-PO-24V-K-7,5-OE
			Plug M8x1, 3-pin	0.3	551392	SIES-8M-PO-24V-K-0,3-M8D
		NPN	Cable, 3-wire	7.5	551401	SIES-8M-NO-24V-K-7,5-OE
			Plug M8x1, 3-pin	0.3	551402	SIES-8M-NO-24V-K-0,3-M8D

Ordering data – Proximity sensors for T-slot, magneto-resistive					Technical data → Internet: smt	
	Type of mounting	Switch output	Electrical connection	Cable length [m]	Part No.	Type
N/O contact						
	Insertable in the slot from above, flush with cylinder profile, short design	PNP	Cable, 3-wire	2.5	574335	SMT-8M-A-PS-24V-E-2,5-OE
			Plug M8x1, 3-pin	0.3	574334	SMT-8M-A-PS-24V-E-0,3-M8D

Ordering data – Connecting cables				Technical data → Internet: nebu	
	Electrical connection, left	Electrical connection, right	Cable length [m]	Part No.	Type
	Straight socket, M8x1, 3-pin	Cable, open end, 3-wire	2.5	541333	NEBU-M8G3-K-2.5-LE3
			5	541334	NEBU-M8G3-K-5-LE3
	Angled socket, M8x1, 3-pin	Cable, open end, 3-wire	2.5	541338	NEBU-M8W3-K-2.5-LE3
			5	541341	NEBU-M8W3-K-5-LE3

Mini slides EGSL, electric

Accessories

FESTO

Adapter kit
HMSV

Materials:
Wrought aluminium alloy
Free of copper and PTFE
RoHS-compliant

 Note
The kit includes the individual mounting interface as well as the necessary mounting material.

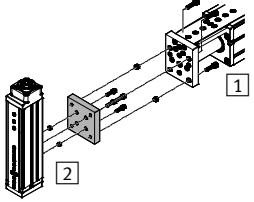
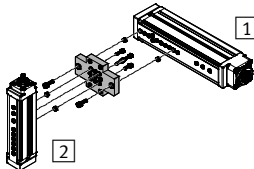
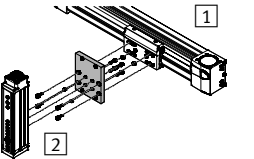
Permissible drive/drive combinations with adapter kit			Download CAD data → www.festo.com				
Combination	1	2	Adapter kit				
	Drive	Drive	CRC ¹⁾	Part No.	Type	Quantity required	PU ²⁾
	EGSL	EGSL	HMSV				
	35	35	2	–	M4x12 DIN 912 ³⁾	4	–
	186717	ZBH-7 ⁴⁾		4	10		
	45, 55	35		1088295	HMSV-71	1	–
	45	45		–	M5x12 DIN 912 ³⁾	4	–
	186717	ZBH-7 ⁴⁾		4	10		
	55	45, 55		–	M5x14 DIN 912 ³⁾	4	–
	186717	ZBH-7 ⁴⁾		4	10		
	75	45, 55		1088311	HMSV-72	1	–
	75	75		–	M6x18 DIN 912 ³⁾	4	–
150927	ZBH-9 ⁴⁾	4		10			
	35	35	2	1088327	HMSV-73	1	1
	45, 55	35, 45		1088338	HMSV-74	1	1
	75	45		1089092	HMSV-75	1	1
	55	55		1088338	HMSV-74	1	1
	75	55, 75		1089092	HMSV-75	1	1
	EGC	EGSL	HMSV				
	50	35	2	1089104	HMSV-76	1	1
	70	35, 45, 55		1089346	HMSV-77	1	1
	80	45, 55, 75		1089520	HMSV-78	1	1
	120	45, 55, 75		1089527	HMSV-79	1	1

- 1) Corrosion resistance class CRC 2 to Festo standard FN 940070
Moderate corrosion stress. Indoor applications in which condensation may occur. External visible parts with primarily decorative requirements for the surface and which are in direct contact with the ambient atmosphere typical for industrial applications.
- 2) Packaging unit quantity.
- 3) The screws listed are not included in the scope of delivery of the drives.
- 4) The centring sleeves are included in the scope of delivery of the drives.