

Cilindros guiados DFM/DFM-B

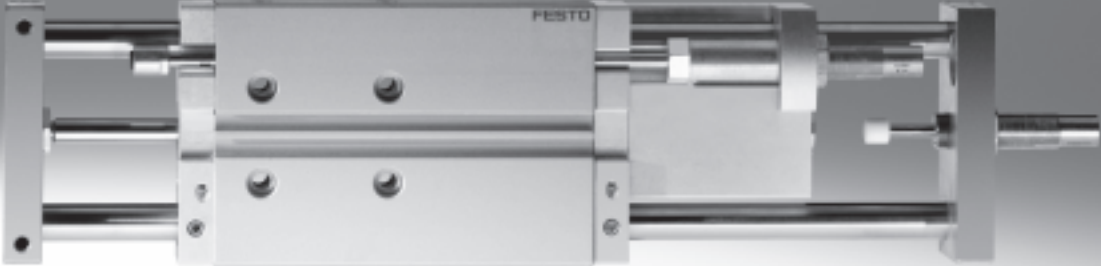

Cilindros guiados DFM/DFM-B

Características

FESTO

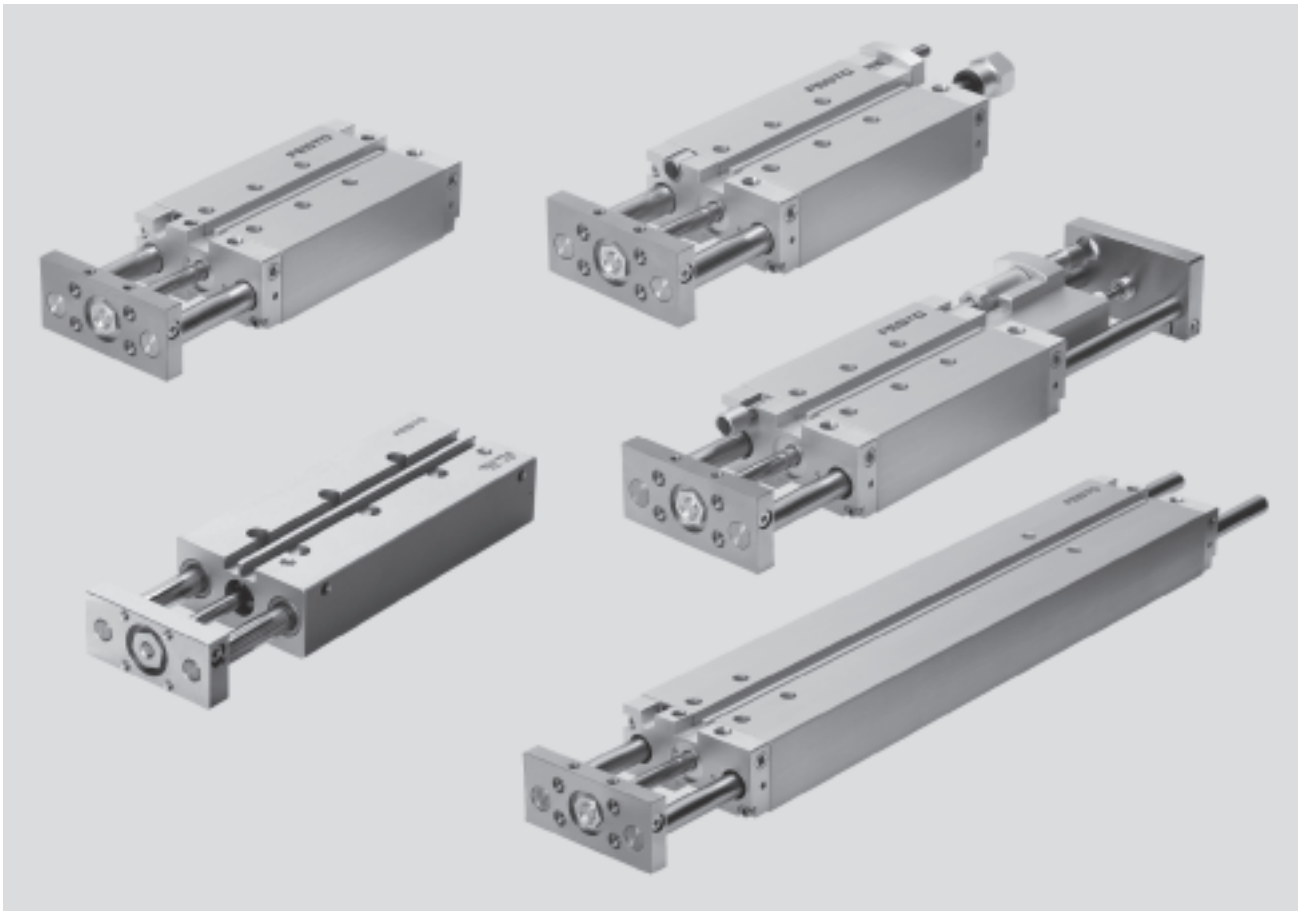

Actuador y guías integrados en un cuerpo

- Diseño compacto
- Tiempos mínimos para el montaje
- Conexión variable del aire comprimido
- Múltiples posibilidades de montaje

Robustos y precisos

- Antigiro fiable
- Gran rigidez
- No precisan mantenimiento

Compensación de grandes momentos y fuerzas transversales

- Con guía de deslizamiento: las barras de guía y los cuatro casquillos deslizantes le confieren una gran rigidez.
- Con guía de rodamiento de bolas: Para movimientos expuestos a momentos de carga.

Numerosas variantes

- Con posiciones finales regulables
- Con amortiguador
- Ejecución de carrera larga
- Con amortiguación neumática PPV en las posiciones finales

Cilindros guiados DFM/DFM-B

Características

FESTO

Aplicaciones en sistemas de transporte

Elevar

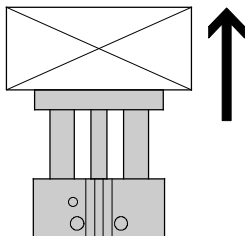

Impulsar

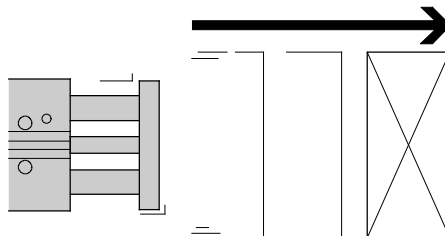

Parar

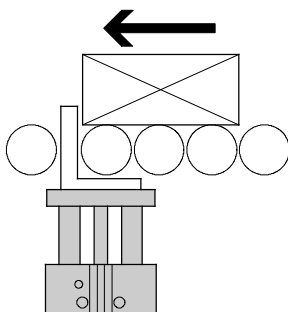

Parar con tope angular

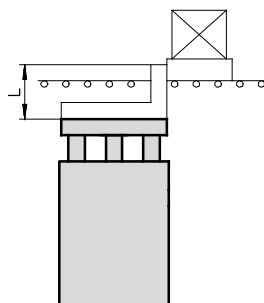

¡Se recomienda el montaje de un tope en el portapiezas!

Posibilidades de montaje

Plano desde arriba

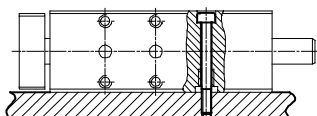

Plano desde abajo

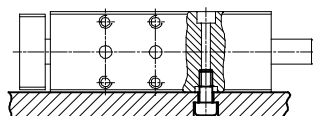

Montaje lateral desde abajo

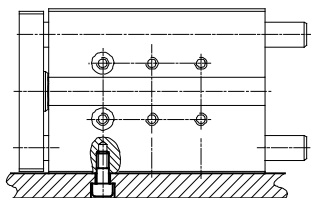



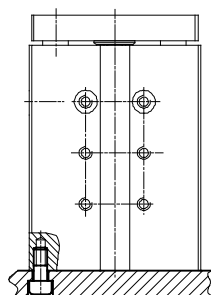





Posterior desde abajo

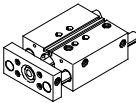
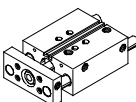
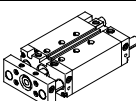

Cilindros guiados DFM/DFM-B

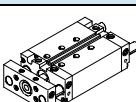
FESTO

Cuadro general de productos

Función	Ejecución	Tipo	Diámetro del émbolo	Carrera	Carrera variable
			[mm]	[mm]	[mm]
Doble efecto	Tipo básico DFM con guía de rodamientos				
		DFM Vástago simple	12, 16	10, 20, 25, 30, 40, 50, 80, 100	–
			20, 25	20, 25, 30, 40, 50, 80, 100	–
			32	20, 25, 30, 40, 50, 80, 100, 125, 160, 200	–
			40, 50, 63, 80, 100	25, 50, 80, 100, 125, 160, 200	–
	Tipo básico DFM con guía deslizante				
		DFM Vástago simple	12, 16	10, 20, 25, 30, 40, 50, 80, 100	–
			20, 25	20, 25, 30, 40, 50, 80, 100	–
			32	20, 25, 30, 40, 50, 80, 100, 125, 160, 200	–
			40, 50, 63, 80, 100	25, 50, 80, 100, 125, 160, 200	–
	Tipo básico DFM-B con guía de rodamientos				
		DFM-B Vástago simple	12, 16	10, 20, 25, 30, 40, 50, 80, 100, 125, 160, 200	10 ... 200 
			20, 25, 32	20, 25, 30, 40, 50, 80, 100, 125, 160, 200, 250, 320, 400	20 ... 400 
			40, 50, 63	25, 50, 80, 100, 125, 160, 200, 250, 320, 400	25 ... 400 
	Tipo básico DFM-B con guía deslizante				
		DFM-B Vástago simple	12, 16	10, 20, 25, 30, 40, 50, 80, 100, 125, 160, 200	10 ... 200 
			20, 25, 32	20, 25, 30, 40, 50, 80, 100, 125, 160, 200, 250, 320, 400	20 ... 400 
			40, 50, 63	25, 50, 80, 100, 125, 160, 200, 250, 320, 400	25 ... 400 

 - Importante
 Software de dimensionado GSED
 → www.festo.com

Cilindros guiados DFM/DFM-B

Cuadro general de productos

Tipo	Detección de posiciones	Amortiguación			Juntas termo-resistentes	Ajuste fino en las posiciones finales		→ Página/Internet
		No regulable	Regulable para masas medianas	Amortiguador hidráulico autorregulable para grandes masas		Posición final con vástago extendido	Posición final con vástago retraído	
	A	P	PPV	YSRW	S6	AJ	EJ	
Tipo básico DFM con guía de rodamientos								
DFM								
Vástago simple	■	■	-	-	-	-	-	8
Tipo básico DFM con guía deslizante								
DFM								
Vástago simple	■	■	-	-	-	-	-	8
Tipo básico DFM-B con guía de rodamientos								
DFM-B								
Vástago simple	■	■	■ A partir de Ø 16	■ A partir de Ø 20	-	■	■ A partir de Ø 20	30
Tipo básico DFM-B con guía deslizante								
DFM-B								
Vástago simple	■	■	■	-	■	■	■	30

Cilindros guiados DFM

Cuadro general de periféricos

FESTO

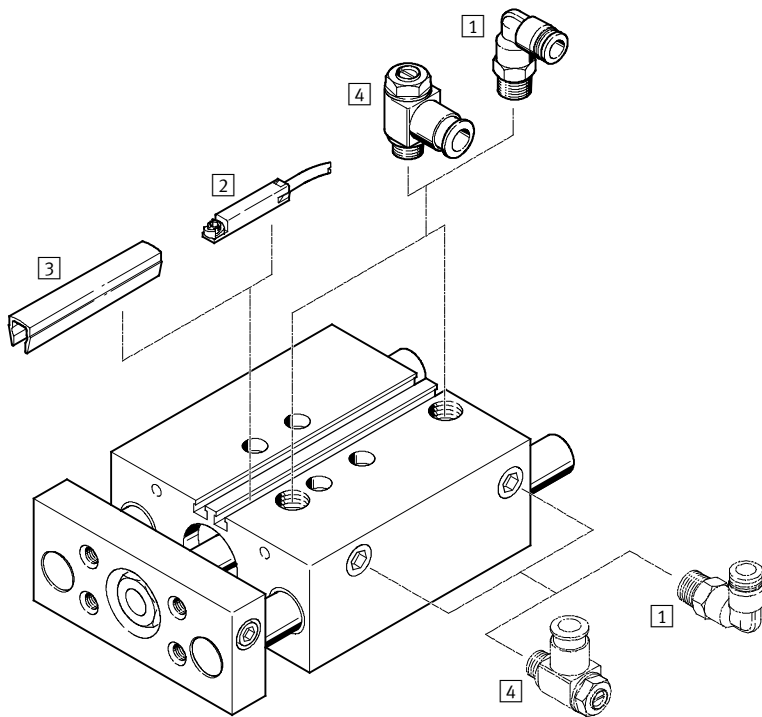

Accesorios		
	Descripción resumida	→ Página/Internet
1	Racor rápido roscado QS	Para la conexión de tubos flexibles con tolerancias en su diámetro exterior quick star
2	Detectores de posición SME-/SMT-8	Integrable en el tubo perfilado 60
3	Tapa para ranuras ABP-5-S	Para proteger los cables de los detectores y las ranuras frente a la suciedad 62
4	Válvula reguladora de caudal GRLA	Para regular la velocidad 62
-	Casquillos para centrar ZBH	4 unidades incluidas en el suministro 60

Cilindros guiados DFM

Código para el pedido

	DFM	50	80	P	A	
Tipo						
Doble efecto						
DFM	Cilindro guiado					
Diámetro del émbolo [mm]						
Carrera [mm]						
Amortiguación						
P	Anillos y discos elásticos en ambos lados					
Detección de posiciones						
A	Para detectores de proximidad					
Guía						
GF	Guía de deslizamiento					
KF	Guías con rodamiento de bolas					

Gran funcionalidad

Sentido del movimiento

Seguridad antigiro, compensación de grandes momentos y fuerzas transversales

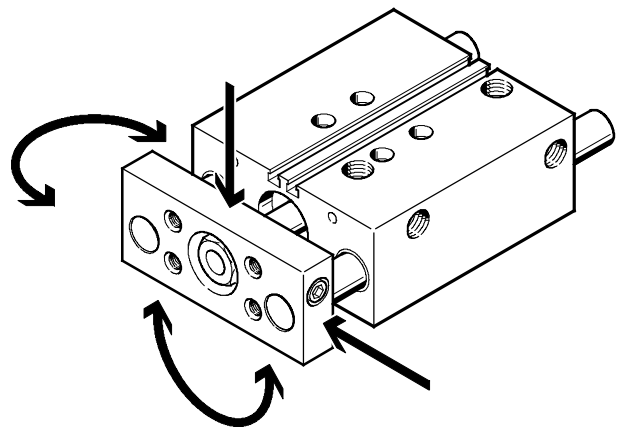
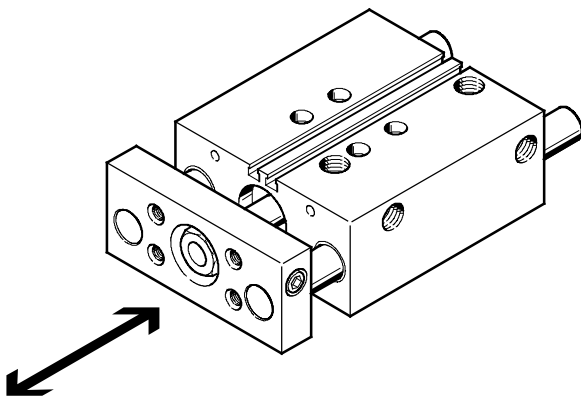

Cilindros guiados DFM

Hoja de datos

FESTO

Función

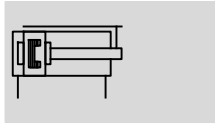

www.festo.com

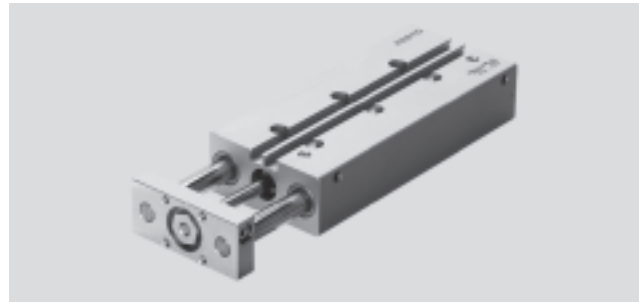

- Diámetro
12 ... 100 mm
- Carrera
10 ... 200 mm

Datos técnicos generales										
Diámetro del émbolo	12	16	20	25	32	40	50	63	80	100
Conexión neumática	M5	M5	M5	G1/8	G1/8	G1/8	G1/4	G1/4	G3/8	G3/8
Fluido de trabajo	Aire comprimido según ISO 8573-1:2010 [7:4:4]									
Nota sobre el fluido de trabajo/mando	Es posible el funcionamiento con aire comprimido lubricado (lo cual requiere seguir utilizando aire lubricado)									
Presión de funcionamiento [bar]	2 ... 10			1,5 ... 10			1 ... 10		0,5 ... 10	
Construcción	Émbolo									
	Vástago									
	Barras de guía con yugo									
Amortiguación	Anillos y discos elásticos en ambos lados									
Detección de posiciones	Para detectores de proximidad									
Tipo de fijación	Mediante taladros									
	Con rosca interior									
Posición de montaje	Indistinta									
Antigiro/Guía	Barra de guía con estribo; guía de deslizamiento o de rodamiento de bolas									

- | - Importante: Este producto cumple con los estándares ISO 1179-1 e ISO 228-1

Condiciones del entorno		
Variante	Guía de deslizamiento GF	Guía de rodamiento de bolas KF
Temperatura ambiente ¹⁾ [°C]	-20 ... +80	-5 ... +60
Clase de resistencia a la corrosión ²⁾	2	-
ATEX	Tipos especiales → www.festo.com	

1) Tener en cuenta las condiciones de funcionamiento de los detectores

2) Clase de resistencia a la corrosión 1 según norma de Festo 940 070

Válida para piezas expuestas a peligro de corrosión. Protección para transporte y almacenamiento. Piezas con superficies sin fines decorativos, por ejemplo, por encontrarse en el interior o detrás de tapas o recubrimientos

Clase de resistencia a la corrosión 2 según norma de Festo 940 070

Válida para piezas expuestas a gran peligro de corrosión. Piezas exteriores en contacto directo con sustancias usuales en entornos industriales, tales como disolventes, detergentes o lubricantes, con superficies principalmente decorativas

Velocidades [m/s]										
Diámetro del émbolo	12	16	20	25	32	40	50	63	80	100
Amortiguación P										
Velocidad máxima en avance	0,8	0,8	0,8	0,8	0,8	0,8	0,6	0,6	0,4	0,4
Velocidad máxima en retroceso	0,8	0,8	0,8	0,8	0,8	0,8	0,6	0,6	0,4	0,4

Fuerzas [N]										
Diámetro del émbolo	12	16	20	25	32	40	50	63	80	100
Fuerza teórica con 6 bar, avance	68	121	188	295	482	754	1 178	1 870	3 016	4 712
Fuerza teórica con 6 bar, retroceso	51	90	141	247	415	686	1 057	1 750	2 827	4 418

Cilindros guiados DFM

Hoja de datos

Energía de impacto [J]										
Diámetro del émbolo	12	16	20	25	32	40	50	63	80	100
Energía máx. de impacto en las posiciones finales	0,09	0,10	0,14	0,35	0,40	0,52	0,64	0,70	0,75	1,00

Velocidad de impacto admisible:
$$v_{adm.} = \sqrt{\frac{2 \times E_{adm.}}{m_{propia} + m_{carga}}}$$

Masa máxima admisible:
$$m_{carga} = \frac{2 \times E_{adm.}}{v^2} - m_{propia}$$

$v_{adm.}$ Velocidad de impacto admisible
 $E_{adm.}$ Energía máx. de impacto
 m_{propia} Masa móvil (actuador)
 m_{carga} Carga útil a mover

 Importante
 Estos valores son valores máximos posibles. Debe tenerse en cuenta la energía máxima admisible del impacto.

DFM con guía deslizante GF										
Carrera [mm]	Diámetro del émbolo [mm]									
	12	16	20	25	32	40	50	63	80	100
Peso del producto [g]										
10	338	449	-	-	-	-	-	-	-	-
20	371	515	777	1 250	1 770	-	-	-	-	-
25	405	540	825	1 270	1 835	2 145	3 431	4 472	6 984	11 000
30	435	571	865	1 340	1 915	-	-	-	-	-
40	494	707	1 060	1 420	2 120	-	-	-	-	-
50	540	770	1 150	1 630	2 230	2 520	4 092	5 213	8 185	12 589
80	690	920	1 350	1 990	2 795	2 980	5 016	6 273	9 743	14 699
100	775	1 085	1 595	2 226	3 092	3 531	5 434	6 791	10 482	15 760
125	-	-	-	-	3 586	3 915	6 338	7 865	11 490	17 094
160	-	-	-	-	3 630	4 520	7 219	8 920	12 910	18 980
200	-	-	-	-	4 777	5 389	8 139	10 172	14 363	21 148
Masa móvil [g]										
10	170	230	-	-	-	-	-	-	-	-
20	190	250	400	650	1 040	-	-	-	-	-
25	190	260	420	670	1 070	1 190	2 050	2 510	4 140	6 300
30	200	280	440	690	1 090	-	-	-	-	-
40	230	340	550	760	1 150	-	-	-	-	-
50	250	370	580	800	1 210	1 330	2 280	2 740	4 720	7 110
80	290	430	680	910	1 480	1 600	2 720	3 190	5 460	8 140
100	320	470	740	990	1 590	1 720	2 910	3 370	5 730	8 520
125	-	-	-	-	1 840	1 960	3 300	3 760	6 080	9 000
160	-	-	-	-	2 040	2 170	3 630	4 090	6 550	9 670
200	-	-	-	-	2 280	2 400	4 000	4 460	7 100	10 430

Cilindros guiados DFM

Hoja de datos

FESTO

DFM con guía de rodamiento de bolas KF										
Carrera [mm]	Diámetro del émbolo [mm]									
	12	16	20	25	32	40	50	63	80	100
Peso del producto [g]										
10	320	424	-	-	-	-	-	-	-	-
20	340	481	732	1 185	1 583	-	-	-	-	-
25	377	507	760	1 215	1 639	1 953	3 135	4 155	6 506	10 520
30	403	535	810	1 288	1 711	-	-	-	-	-
40	466	647	967	1 425	1 849	-	-	-	-	-
50	508	704	1 050	1 534	1 993	2 342	3 704	4 880	7 582	11 980
80	560	878	1 290	1 871	2 425	2 867	4 489	5 791	8 895	13 612
100	723	988	1 330	2 089	2 726	3 166	4 930	6 337	9 500	14 587
125	-	-	-	-	3 627	3 616	5 626	7 860	10 485	15 820
160	-	-	-	-	3 890	4 161	6 409	8 110	11 750	17 545
200	-	-	-	-	4 189	4 798	7 550	9 300	13 214	21 124
Masa móvil [g]										
10	150	200	-	-	-	-	-	-	-	-
20	160	220	360	590	860	-	-	-	-	-
25	160	230	380	600	880	1 000	1 720	2 180	3 670	5 700
30	170	240	390	620	900	-	-	-	-	-
40	190	290	480	670	960	-	-	-	-	-
50	200	300	500	700	980	1 100	1 880	2 340	4 090	6 320
80	230	350	570	790	1 160	1 280	2 180	2 640	4 630	7 110
100	250	380	620	850	1 240	1 360	2 310	2 770	4 840	7 410
125	-	-	-	-	1 400	1 530	2 580	3 040	5 090	7 780
160	-	-	-	-	1 540	1 670	2 810	3 270	5 450	8 310
200	-	-	-	-	1 710	1 830	3 070	3 530	5 860	8 910

Materiales

Vista en sección

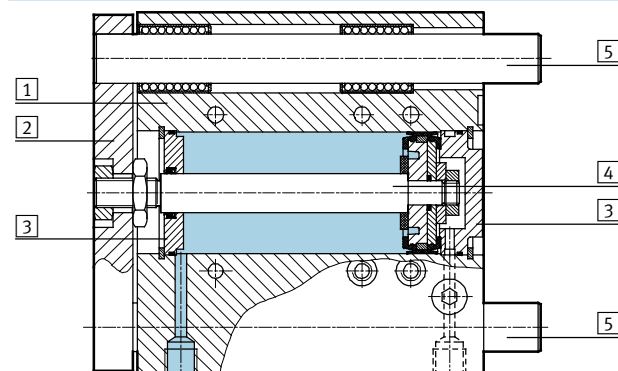

Cilindro guiado	Guía de deslizamiento GF	Guía de rodamiento de bolas KF
1 Cuerpo	Aleación forjada de aluminio anodizado	Aleación forjada de aluminio anodizado
2 Yugo	Acero templado	Acero templado
3 Culatas anterior y posterior	Aleación forjada de aluminio anodizado	Aleación forjada de aluminio anodizado
4 Vástago	Acero de aleación fina, inoxidable	Acero de aleación fina, inoxidable
5 Barras de guía	Acero de aleación fina, inoxidable	Acero templado
- Juntas estáticas	Caucho nitrílico	Caucho nitrílico
- Juntas dinámicas	Poliuretano	Poliuretano
Calidad del material	Conformidad con RoHS	

Cilindros guiados DFM

Hoja de datos

FESTO

Carga útil máxima F [N]

Guía deslizante GF y de rodamiento de bolas KF

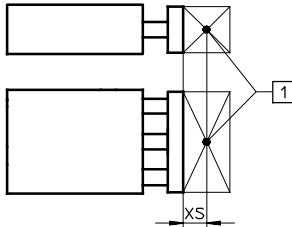

1 Centro de gravedad de la carga útil

Diámetro del émbolo [mm]	XS [mm]	Carrera [mm]											
		10	20	25	30	40	50	80	100	125	160	200	
12	GF	25	28	24	23	21	31	28	22	19	-	-	-
	KF		27	23	21	20	23	22	20	19	-	-	-
16	GF	50	63	56	53	51	73	67	55	49	-	-	-
	KF		45	31	27	24	58	56	51	48	-	-	-
20	GF	50	-	67	64	61	110	103	86	77	-	-	-
	KF		-	45	39	35	91	88	80	75	-	-	-
25	GF	50	-	121	116	112	123	115	96	86	-	-	-
	KF		-	88	86	84	100	97	89	85	-	-	-
32	GF	50	-	188	180	173	161	150	166	150	168	146	127
	KF		-	120	118	116	112	109	134	128	144	135	126
40	GF	50	-	-	180	-	-	150	166	150	168	146	127
	KF		-	-	118	-	-	109	134	128	144	135	126
50	GF	50	-	-	257	-	-	216	234	212	229	200	174
	KF		-	-	182	-	-	168	201	193	211	199	188
63	GF	50	-	-	257	-	-	216	234	212	229	200	174
	KF		-	-	182	-	-	168	201	193	211	199	188
80	GF	125	-	-	276	-	-	311	352	329	304	274	245
	KF		-	-	220	-	-	275	329	318	306	291	277
100	GF	125	-	-	452	-	-	509	568	533	494	446	400
	KF		-	-	332	-	-	415	495	480	463	442	422

Momento admisible M [Nm]

Guía deslizante GF y de rodamiento de bolas KF

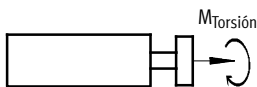

Diámetro del émbolo [mm]		Carrera [mm]										
		10	20	25	30	40	50	80	100	125	160	200
12	GF	0,60	0,50	0,48	0,45	0,65	0,60	0,45	0,40	-	-	-
	KF	0,55	0,47	0,44	0,42	0,47	0,45	0,41	0,38	-	-	-
16	GF	1,44	1,30	1,23	1,18	1,68	1,56	1,28	1,14	-	-	-
	KF	1,03	0,71	0,62	0,55	1,34	1,29	1,18	1,12	-	-	-
20	GF	-	1,85	1,75	1,70	3,00	2,80	2,35	2,10	-	-	-
	KF	-	1,30	1,13	1,01	2,64	2,56	2,34	2,23	-	-	-
25	GF	-	4,15	3,95	3,80	4,20	3,90	3,25	2,90	-	-	-
	KF	-	3,00	2,92	2,85	3,40	3,30	3,02	2,89	-	-	-
32	GF	-	7,30	7,00	6,70	6,20	5,80	6,40	5,80	6,50	5,70	5,00
	KF	-	4,70	4,60	4,55	4,40	4,25	5,25	5,00	5,60	5,25	4,90
40	GF	-	-	7,90	-	-	6,55	7,25	6,55	7,35	6,40	5,55
	KF	-	-	5,20	-	-	4,80	5,90	5,65	6,35	5,95	5,55
50	GF	-	-	14,15	-	-	11,85	12,85	11,65	12,55	11,00	9,60
	KF	-	-	10,00	-	-	9,30	11,00	10,60	11,60	11,00	10,30
63	GF	-	-	15,90	-	-	13,30	14,45	13,10	14,10	12,30	10,70
	KF	-	-	11,30	-	-	10,50	12,50	12,00	13,20	12,40	11,70
80	GF	-	-	21,40	-	-	24,20	27,20	25,50	23,50	21,30	19,00
	KF	-	-	17,10	-	-	21,30	25,50	24,70	23,70	22,60	21,50
100	GF	-	-	42,40	-	-	47,80	53,40	50,10	46,40	42,00	37,60
	KF	-	-	25,70	-	-	32,20	38,40	37,20	35,90	34,20	32,70

- - Importante

Software de dimensionado GSED

→ www.festo.com

Cilindros guiados DFM

Hoja de datos

FESTO

Holgura torsional ρ

Guía deslizante GF y guía de rodamiento de bolas KF, retraída, sin carga

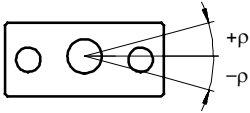

Diámetro del émbolo		12	16	20	25	32	40	50	63	80	100
Holgura torsional [°]	GF	0,09	0,09	0,07	0,07	0,06	0,06	0,05	0,05	0,03	0,03
	KF	0,08	0,08	0,07	0,07	0,05	0,05	0,05	0,05	0,03	0,03

Desviación del vástago

Holgura de la guía deslizante GF y de la guía de rodamiento de bolas KF (sin carga)

DFM-12 ... 20 carrera \leq 30 mm:

DFM-12 ... 20 carrera > 30 mm

DFM-25 ... 100:

1 apoyo por barra de guía

2 apoyos por barra de guía

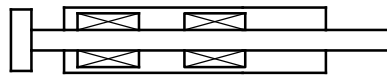
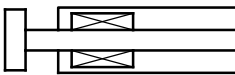

Diámetro del émbolo		12	16	20	25	32	40	50	63	80	100
Holgura del cojinete [mm]	GF	0,11	0,11	0,11	0,10	0,13	0,13	0,12	0,12	0,12	0,12
	KF	0,10	0,08	0,08	0,08	0,08	0,08	0,08	0,08	0,07	0,07

Desviación media f_1 debido a la holgura del cojinete en función de la carrera l

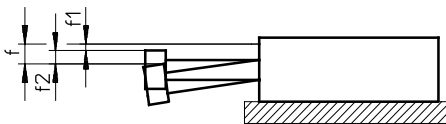

$$f = f_1 + f_2$$

f = desviación total del vástago

f_1 = desviación por holgura del cojinete

f_2 = desviación por fuerza lateral

DFM con 2 apoyos por barra de guía

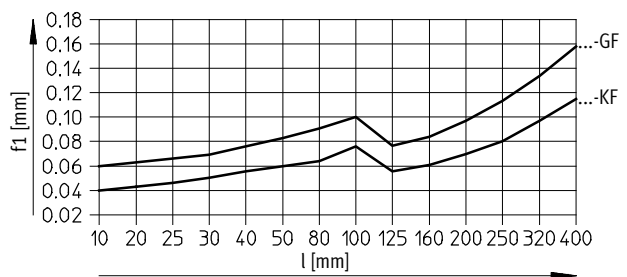

Cilindros guiados DFM

Hoja de datos

Utilización como cilindro de tope

En caso de utilización como cilindro de tope, únicamente deberán utilizarse cilindros con guía deslizante DFM-...-GF.

Además, no deberá superarse la distancia $l_{m\acute{a}x.}$ (→ dibujo).

Tampoco debe superarse la energía cinética de impacto máxima admisible en el tope final.

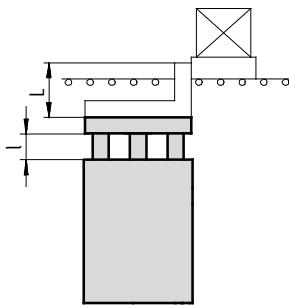

$$l_{m\acute{a}x.} = \text{Carrera } l + \text{Altura del ángulo del tope } L$$

$$l_{m\acute{a}x.} = 50 \text{ mm}$$

Masa de impacto m en función de la velocidad del impacto v

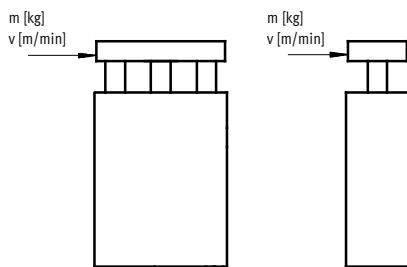

DFM-12 ... 25-GF
Carrera < 30 mm

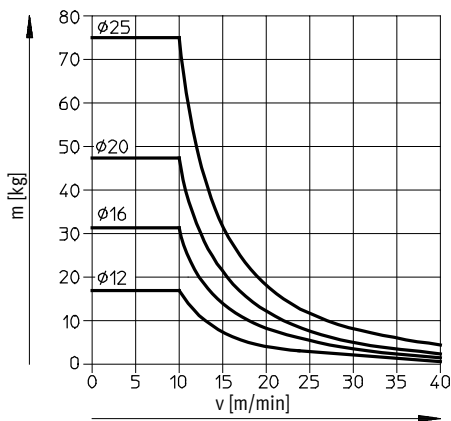

Los valores que constan en el diagrama suponen la existencia de un tope elástico con deformación de 1 mm montado en el soporte de las piezas. Únicamente pueden utilizarse cilindros guiados de deslizamiento GF < 30 mm de carrera.

DFM-32 ... 100-GF
Carrera < 50 mm

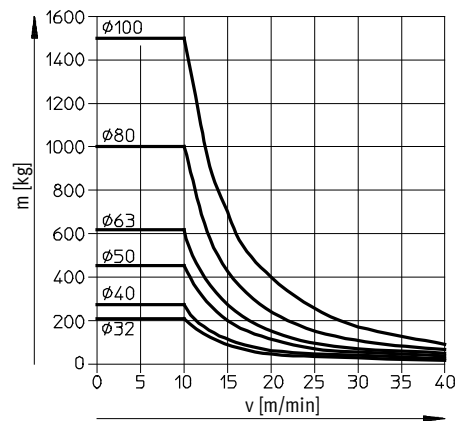

Los valores que constan en el diagrama suponen la existencia de un tope elástico con deformación de 2 mm montado en el soporte de las piezas. Únicamente pueden utilizarse cilindros guiados de deslizamiento GF < 50 mm de carrera.

Cilindros guiados DFM

Hoja de datos

FESTO

Utilización como cilindro elevador

Carga admisible con guía deslizante GF

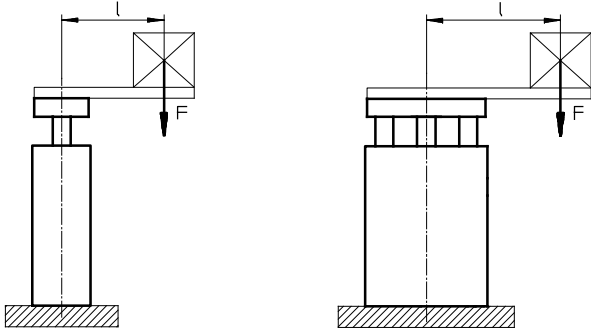

F = Fuerza longitudinal [N]
l = Palanca [mm]

DFM-12 ... 25-GF
Carrera 30 mm

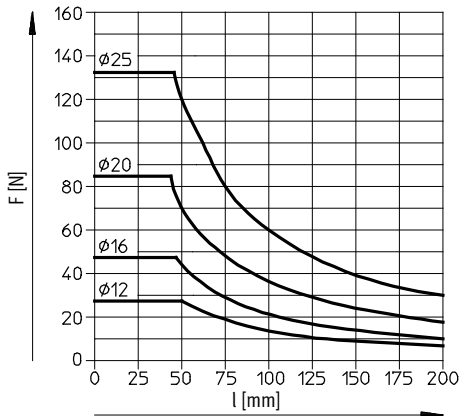

DFM-12 ... 25-GF
Carrera 40 ...100 mm

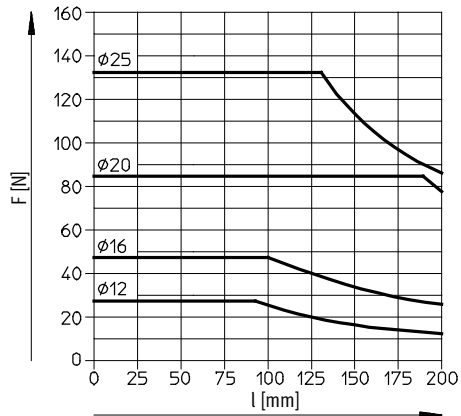

DFM-32 ... 63-GF
Carrera 50 mm

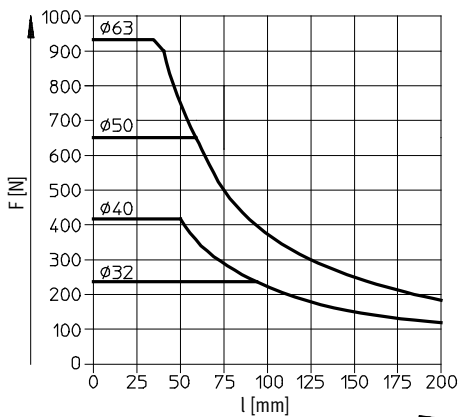

DFM-32 ... 63-GF
Carrera 80 ...100 mm

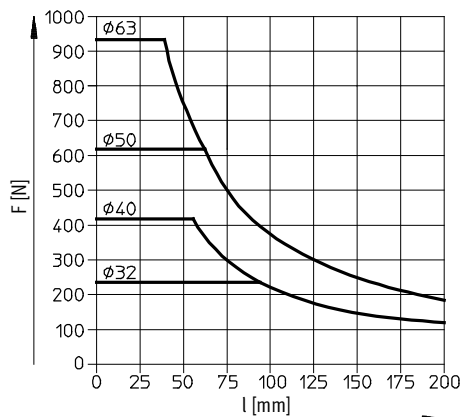

Cilindros guiados DFM

Hoja de datos

Utilización como cilindro elevador

Carga admisible con guía deslizante GF

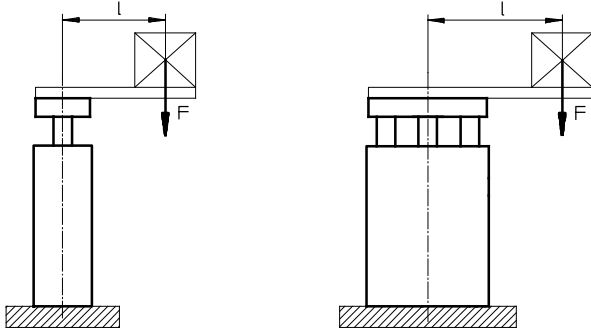

F = Fuerza longitudinal [N]

l = Palanca [mm]

DFM-32 ... 63-GF

Carrera 125 ... 200 mm

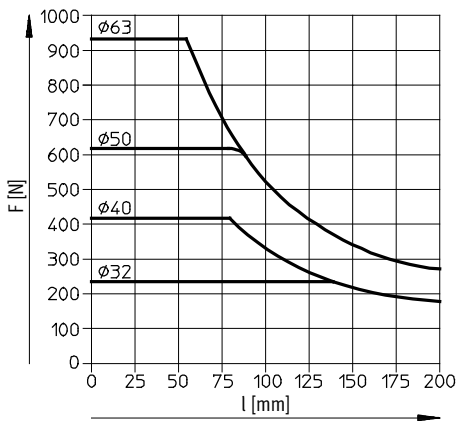

DFM-80 ... 100-GF

Carrera 25 mm

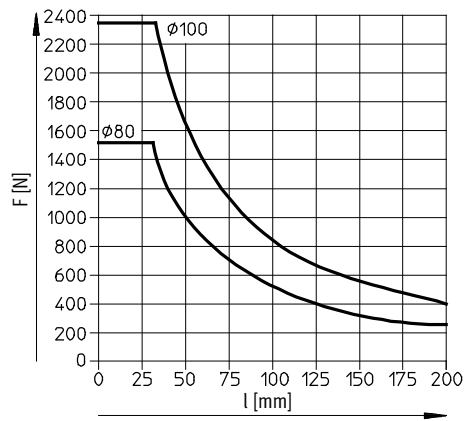

DFM-80 ... 100-GF

Carrera 50 mm

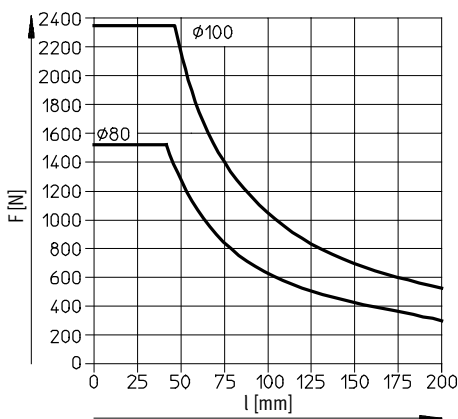

DFM-80 ... 100-GF

Carrera 80 ... 200 mm

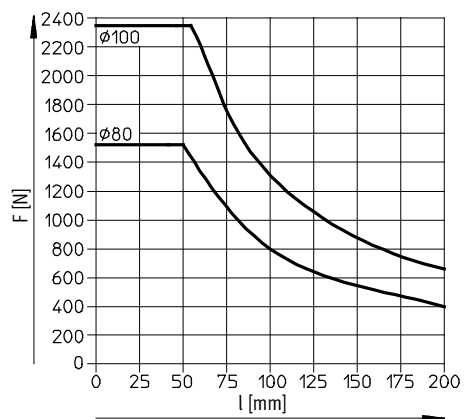

Cilindros guiados DFM

Hoja de datos

FESTO

Utilización como cilindro elevador

Carga admisible con guía de rodamiento de bolas KF

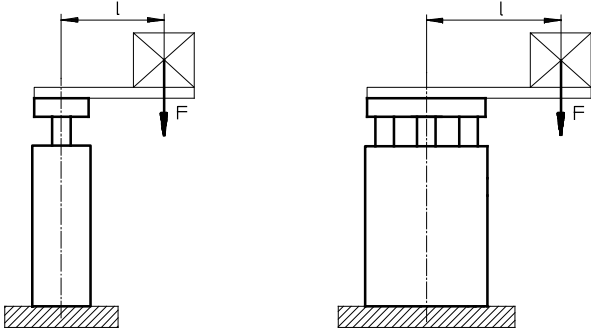

F = Fuerza longitudinal [N]
l = Palanca [mm]

DFM-12 ... 25-KF
Carrera 30 mm

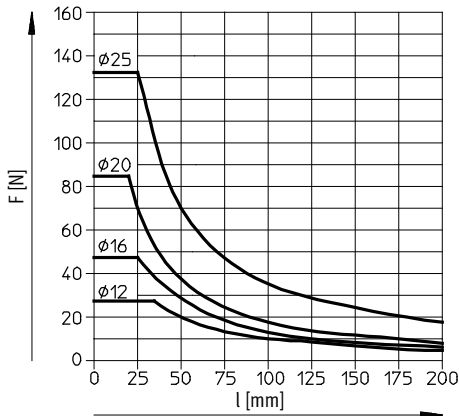

DFM-12 ... 25-KF
Carrera 40 ... 100 mm

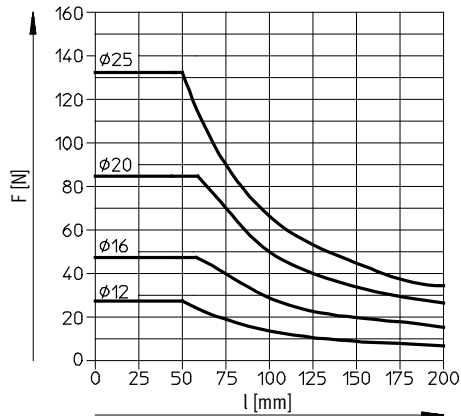

DFM-32 ... 63-KF
Carrera 50 mm

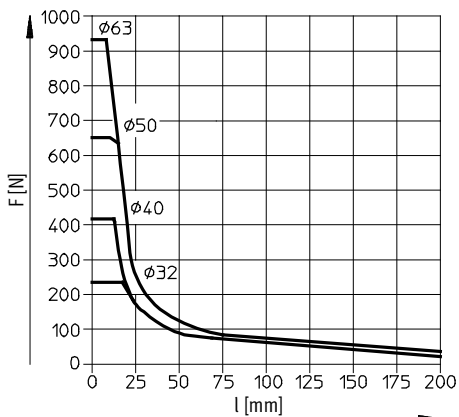

DFM-32 ... 63-KF
Carrera 80 ... 100 mm

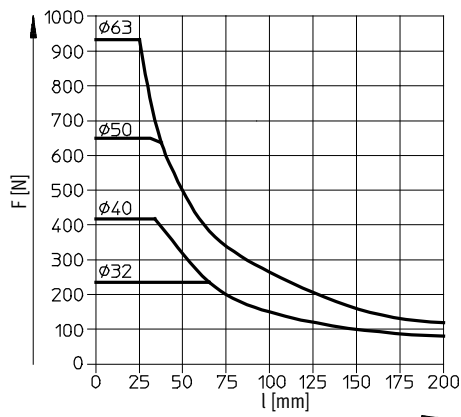

Cilindros guiados DFM

Hoja de datos

Utilización como cilindro elevador

Carga admisible con guía de rodamiento de bolas KF

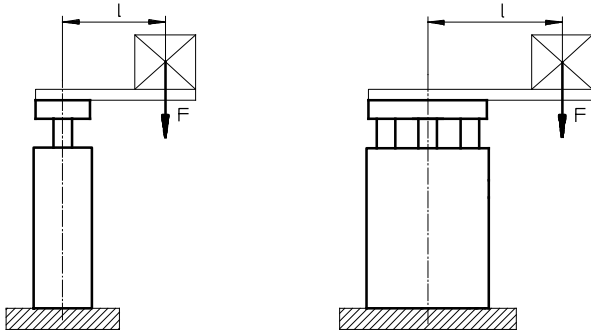

F = Fuerza longitudinal [N]

l = Palanca [mm]

DFM-32 ... 63-KF

Carrera 125 ... 200 mm

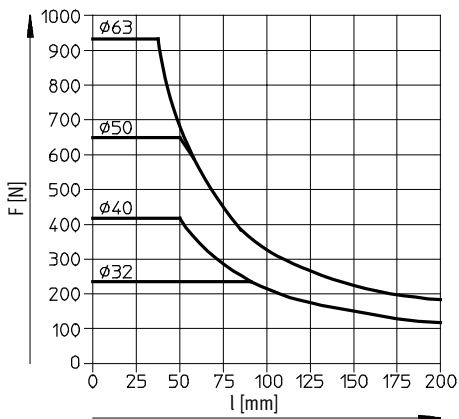

DFM-80 ... 100-KF

Carrera 25 mm

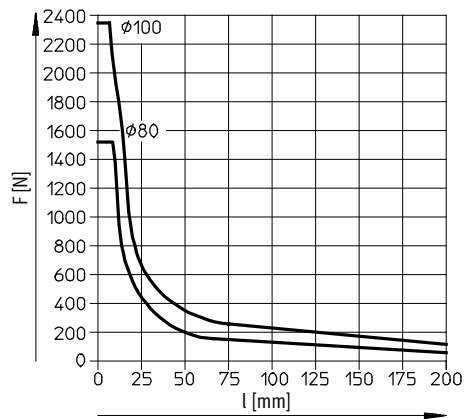

DFM-80 ... 100-KF

Carrera 50 mm

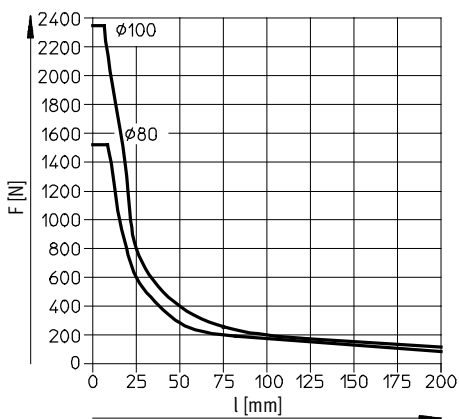

DFM-80 ... 100-KF

Carrera 80 ... 200 mm

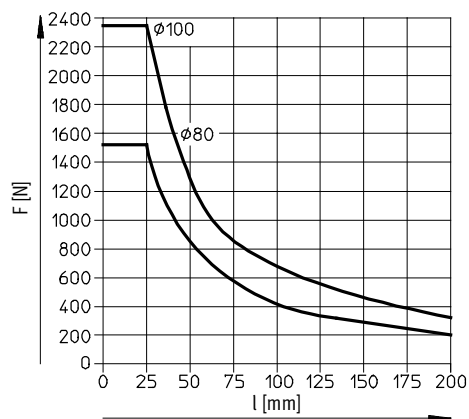

Cilindros guiados DFM

Hoja de datos

FESTO

Dimensiones

Datos CAD disponibles en → www.festo.com

Diámetro del émbolo 12 ... 16 mm

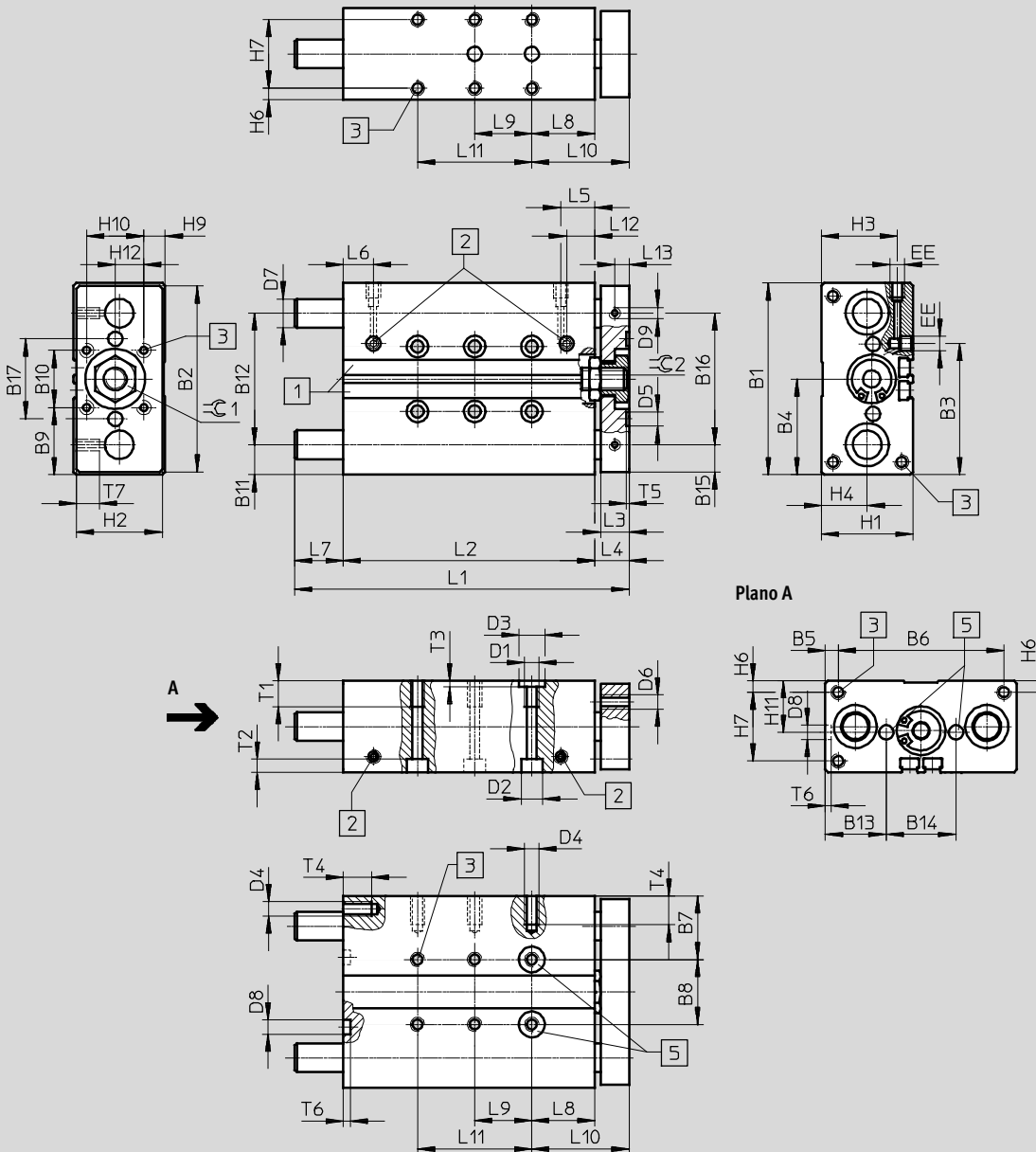

1 Ranura para detectores de proximidad SME-/SMT-8

2 Conexión de aire arriba o lateralmente
3 Rosca de fijación

5 Tolerancia entre los taladros para centrar: $\pm 0,02$ mm

-  - Importante

Si las barras de guía sobresalen en la parte posterior del cuerpo (→ medida L7), debe compensarse el espacio de montaje correspondien-

temente en la parte frontal, para que las barras puedan moverse libremente.

Cilindros guiados DFM

Hoja de datos

∅ [mm]	B1	B2	B3	B4	B5	B6	B7	B8	B9	B10	B11	B12	B13	B14	B15	B16	B17	D1	D2 ∅	D3 ∅ H7
12	60	58	42,4	30	4,5	51	20,5	19	20	20	9,5	41	19,5	21	8,5	41	25	M5	8	9
16	67	65	45,9	33,5	4,5	58	22	23	23,5	20	10,5	46	21,3	24,4	-	-	28	M5	7,5	9

∅ [mm]	D4	D5 ∅ H7	D6	D7 ∅		D8 ∅ H7	D9	EE	H1	H2	H3	H4	H6	H7	H9	H10	H11	H12
				GF	KF													
12	M4	5	M4	10 _{h8}	8 _{h6}	5	M4	M5	28	26	24	14	4	20	4	20	14	10
16	M5	5	M5	12 _{h8}	10 _{h6}	5	-	M5	32	30	26,5	16	4	24	7,4	20	16	10

∅ [mm]	Ca- rrera [mm]	L1	L2	L3	L4	L5	L6	L7	L8	L9	L10 ±0,1	L11
12	10	59	46	10	13	11,4	9,5	-	21	-	34	-
	20	69	56					-		-		
	25	74	61					-		20		-
	30	79	66					-		20		-
	40	95	76					6		20		-
	50	105	86					6		40		-
	80	135	116					6		40		-
	100	155	136					6		40		80
16	10	60	48	10	12	11,9	10,6	-	22	-	34	-
	20	70	58					-		-		
	25	75	63					-		20		-
	30	80	68					-		20		-
	40	107	78					17		20		-
	50	117	88					17		40		-
	80	147	118					17		40		-
	100	167	138					17		40		80

∅ [mm]	Ca- rrera [mm]	L12	L13	T1	T2	T3	T4	T5	T6	T7	≈C1	≈C2
12	10	11,4	5	9	9,4	2,1	8	1,2	1	8	10	10
	20											
	25											
	30											
	40											
	50											
	80											
16	10	11,9	-	9	4,6	2,1	10	1,2	1	-	14	14
	20											
	25											
	30											
	40											
	50											
	80											
100												

Cilindros guiados DFM

Hoja de datos

FESTO

Dimensiones

Datos CAD disponibles en → www.festo.com

Diámetro del émbolo 20 ... 25 mm

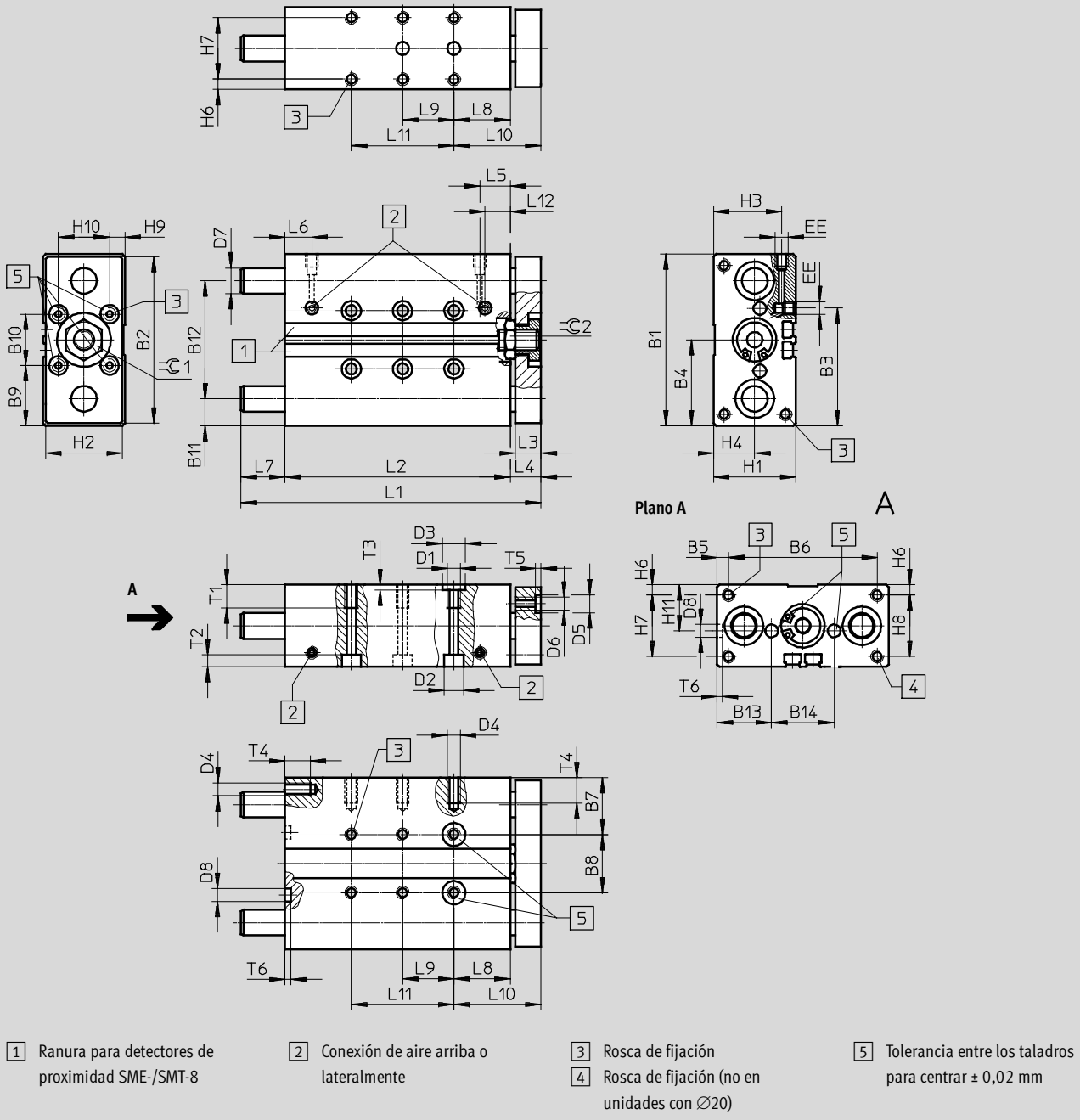

-  - Importante

Si las barras de guía sobresalen en la parte posterior del cuerpo (→ medida L7), debe compensarse el espacio de montaje correspon-

dientemente en la parte frontal, para que las barras puedan moverse libremente.

Cilindros guiados DFM

Hoja de datos

∅ [mm]	B1	B2	B3	B4	B5	B6	B7	B8	B9	B10	B11	B12	B13	B14	D1	D2 ∅	D3 ∅ H7	D4
20	83	81	53,6	41,5	6,5	70	26,5	30	26,5	30	12,5	58	26	31	M6	9	9	M5
25	95	93	70	47,5	15,5	64	30	35	27,5	40	13,5	68	29	37	M6	9	9	M6

∅ [mm]	D5 ∅ H7	D6	D7 ∅		D8 ∅ H7	EE	H1	H2	H3	H4	H6	H7	H8	H9	H10	H11
			GF	KF												
20	9	M5	14h8	12h6	7	M5	36	34	29,5	17	4,5	27	-	7	20	18
25	9	M6	16h8	14h6	7	G1/8	44	42	34,8	19	4,5	35	35	12	20	22

∅ [mm]	Ca- rrera [mm]	L1	L2	L3	L4	L5	L6	L7	L8	L9	L10 ±0,1	L11
25	25	80	66	-	20							
30	30	85	71	-	20							
40	40	121	81	26	20							
50	50	131	91	26	40							
80	80	161	121	26	40							
100	100	181	141	26	40							
25	20	93	65,6	12	14	17,5	9,5	26	26	40	13,4	-
25	25	98	70,6								13,4	20
30	30	103	75,6								13,4	20
40	40	123	85,6								23,4	20
50	50	133	95,6								23,4	40
80	80	163	125,6								23,4	40
100	100	183	145,6								23,4	40

∅ [mm]	Ca- rrera [mm]	L12	T1	T2	T3	T4	T5	T6	≈C1	≈C2
20	20	14	12	5,7	2,1	10	2,1	1,6	17	17
	25									
	30									
	40									
	50									
	80									
25	20	15	14	5,7	2,1	12	2,1	1,6	17	17
	25									
	30									
	40									
	50									
	80									

• | Importante: Este producto cumple con los estándares ISO 1179-1 e ISO 228-1

Cilindros guiados DFM

Hoja de datos

FESTO

Dimensiones

Datos CAD disponibles en → www.festo.com

Diámetro del émbolo 32 ... 63 mm

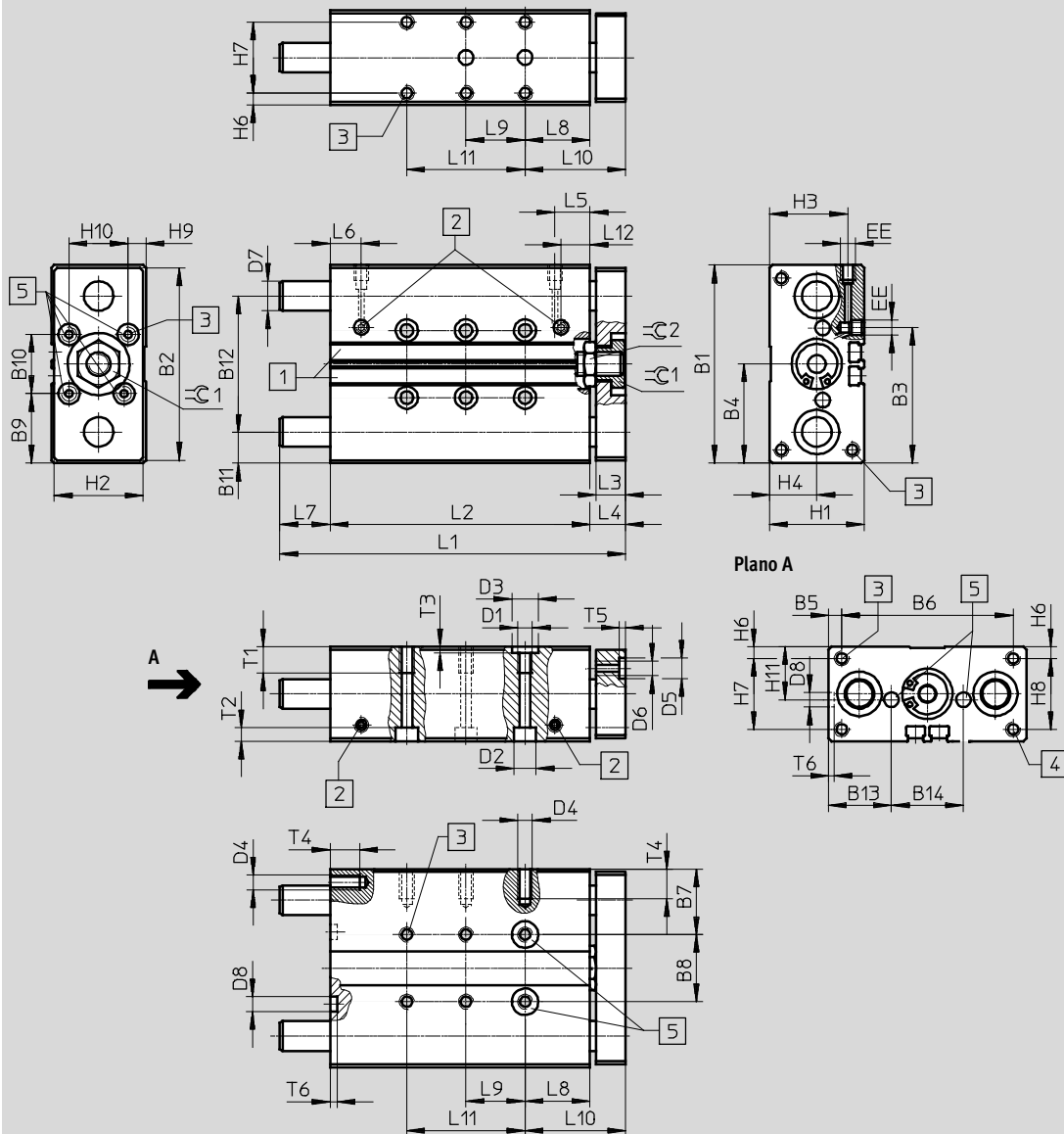

- 1** Ranura para detectores de proximidad SME-/SMT-8
- 2** Conexión de aire arriba o lateralmente
- 4** Rosca de fijación
- 5** Tolerancia entre los taladros para centrar ±0,02 mm
- 3** Rosca de fijación

- Importante
 Considerando que las barras de guía sobresalen en la parte posterior del cuerpo (→ medida L7), debe compensarse el espacio de montaje correspondientemente en la parte frontal, para que las barras puedan moverse libremente.

Cilindros guiados DFM

Hoja de datos

∅ [mm]	B1	B2	B3	B4	B5	B6	B7	B8	B9	B10	B11	B12	B13	B14	D1	D2 ∅	D3 ∅ H7	D4
32	110	108	81	55	20	70	33,5	43	35	40	16	78	32,5	45	M8	11	12	M6
40	120	118	94	60	15	90	34,5	51	35	50	16	88	32,5	55	M8	11	12	M8
50	148	146	116,5	74	19	110	42	64	44	60	19	110	40	68	M8	11	12	M8
63	162	160	139	81	9	144	41	80	41	80	18,4	125	39,5	83	M10	15	12	M10

∅ [mm]	D5 ∅ H7	D6	D7 ∅		D8 ∅ H7	EE	H1	H2	H3	H4	H6	H7	H8	H9	H10	H11
			GF	KF												
32	9	M6	20h8	16h6	9	G $\frac{1}{8}$	49	47	38,5	22	6	37	37	8,5	30	24,5
40	9	M6	20h8	16h6	9	G $\frac{1}{8}$	54	52	40,5	24	6	42	42	10	30	27
50	12	M8	25h8	20h6	12	G $\frac{1}{4}$	64	62	50,5	29,5	7	50	50	12	40	32
63	12	M8	25h8	20h6	12	G $\frac{1}{4}$	78	76	55	32	9	60	60	19	40	39

∅ [mm]	Ca- rrera [mm]	L1	L2	L3	L4	L5	L6	L7	L8	L9	L10	L11	L12	T1	T2	T3	T4	T5	T6	=C1	=C2
											±0,1										
32	20	101	68	14	16	17	12	17	29	-	45	-	17	15	6,8	2,6	12	2,1	2,1	17	22
	25	106	73					17		20		-									
	30	111	78					17		20		-									
	40	121	88					17		20		-									
	50	131	98					17		40		-									
	80	179	128					35		40		-									
	100	199	148					35		40		80									
	125	244	173					55		40		80									
	160	279	208					55		40		120									
	200	319	248					55		40		160									
40	25	106	76	14	16	17,8	13,1	14	29	20	45	-	17,8	15	6,8	2,6	16	2,1	2,1	17	22
	50	131	101					14		40		-									
	80	179	131					32		40		-									
	100	199	151					32		40		80									
	125	244	176					52		40		80									
	160	279	211					52		40		120									
	200	319	251					52		40		160									
50	25	118	77	16	18	17,8	14,2	23	32	20	50	-	17,8	15	6,8	2,6	16	2,6	2,6	19	24
	50	143	102					23		40		-									
	80	194	132					44		40		-									
	100	214	152					44		40		80									
	125	259	177					64		40		80									
	160	294	212					64		40		120									
	200	334	252					64		40		160									
63	25	118	83	16	18	18,5	14,8	17	32	20	50	-	18,5	20	9	2,6	20	2,6	2,6	19	24
	50	143	108					17		40		-									
	80	194	138					38		40		80									
	100	214	158					38		40		80									
	125	259	183					58		40		120									
	160	294	218					58		40		160									
	200	334	258					58		40		200									

· † · Importante: Este producto cumple con los estándares ISO 1179-1 e ISO 228-1

Cilindros guiados DFM

Hoja de datos

FESTO

Dimensiones

Datos CAD disponibles en www.festo.com

Diámetro del émbolo 80 ... 100 mm

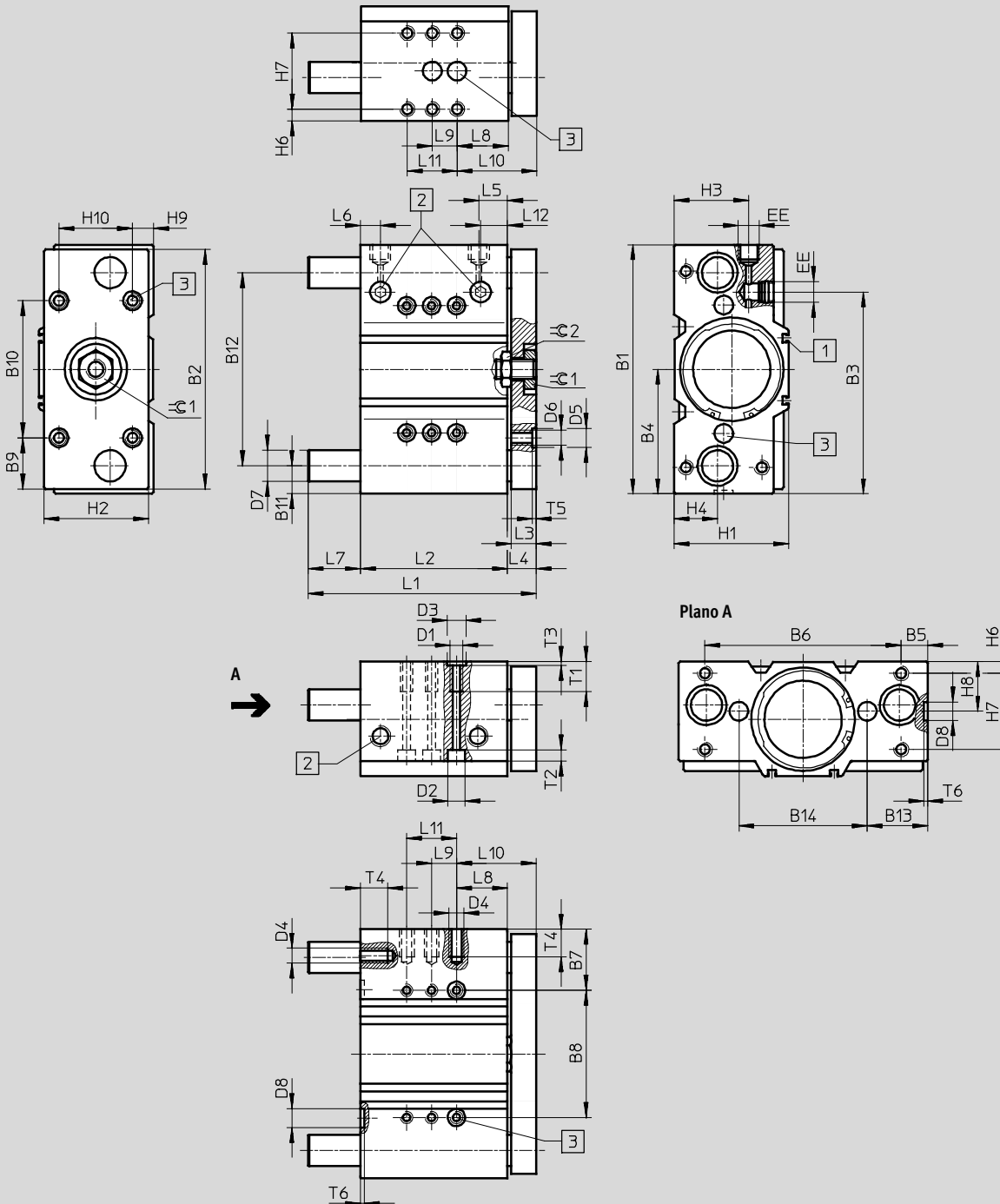

1 Ranura para detectores de proximidad SME-/SMT-8

2 Conexión de aire arriba o lateralmente

3 Tolerancia entre los taladros para centrar $\pm 0,02$ mm

-  - Importante

Considerando que las barras de guía sobresalen en la parte posterior del cuerpo (\rightarrow medida L7), debe compensarse el espacio de montaje

correspondientemente en la parte frontal, para que las barras puedan moverse libremente.

Cilindros guiados DFM

Hoja de datos



∅ [mm]	B1	B2	B3	B4	B5	B6	B7	B8	B9	B10	B11	B12	B13	B14	D1	D2 ∅	D3 ∅ H7
80	200	192	162,5	100	21,5	157	48,5	103	41	110	22,5	155	48,5	103	M10	15	12
100	240	232	201	120	21	198	54	132	56	120	26	188	57	126	M12	18	15

∅ [mm]	D4	D5 ∅ H7	D6	D7 ∅		D8 ∅ H7	EE	H1	H2	H3	H4	H6	H7	H8	H9	H10
				GF	KF											
80	M10	12	M10	30h8	25h6	12	G $\frac{3}{8}$	92	84	61	35	9	62	40	16	60
100	M12	15	M12	35h8	30h6	15	G $\frac{3}{8}$	112	104	66	39,5	10	68	44	16	80

∅ [mm]	Ca- rrera [mm]	L1	L2	L3	L4	L5	L6	L7	L8	L9	L10 ±0,1	L11	L12	T1	T2	T3	T4	T5	T6	≈C1	≈C2
80	25	137	93	20	23	23	16	21	41	40	64	-	23	20	9	2,6	20	2,6	2,6	27	30
	50	183	118					42				40									
	80	243	148					72				40									
	100	263	168					72				80									
	125	288	193					72				80									
	160	323	228					72				120									
	200	363	268					72				160									
100	25	150	109	20	23	29	20	18	13	40	36	-	29	25	11	3,1	24	3,1	3,1	32	30
	50	197	134					40				80									
	80	257	164					70				80									
	100	277	184					70				120									
	125	302	209					70				160									
	160	337	244					70				160									
	200	377	284					70				200									

· | · Importante: Este producto cumple con los estándares ISO 1179-1 e ISO 228-1

Cilindros guiados DFM

Hoja de datos

FESTO

Referencias: guía deslizante GF											
Nº de art. Tipo			Nº de art. Tipo			Nº de art. Tipo					
Carrera [mm]			Diámetro del émbolo: 12 mm			Diámetro del émbolo: 16 mm			Diámetro del émbolo: 20 mm		
10	170 824	DFM-12-10-P-A-GF	170 832	DFM-16-10-P-A-GF	–	–	–	–	–	–	
20	170 825	DFM-12-20-P-A-GF	170 833	DFM-16-20-P-A-GF	170 840	DFM-20-20-P-A-GF	170 841	DFM-20-25-P-A-GF	170 842	DFM-20-30-P-A-GF	
25	170 826	DFM-12-25-P-A-GF	170 834	DFM-16-25-P-A-GF	170 843	DFM-20-40-P-A-GF	170 844	DFM-20-50-P-A-GF	170 845	DFM-20-80-P-A-GF	
30	170 827	DFM-12-30-P-A-GF	170 835	DFM-16-30-P-A-GF	170 846	DFM-20-100-P-A-GF	–	–	–	–	
40	170 828	DFM-12-40-P-A-GF	170 836	DFM-16-40-P-A-GF	–	–	–	–	–	–	
50	170 829	DFM-12-50-P-A-GF	170 837	DFM-16-50-P-A-GF	–	–	–	–	–	–	
80	170 830	DFM-12-80-P-A-GF	170 838	DFM-16-80-P-A-GF	–	–	–	–	–	–	
100	170 831	DFM-12-100-P-A-GF	170 839	DFM-16-100-P-A-GF	–	–	–	–	–	–	
125	–	–	–	–	–	–	–	–	–	–	
160	–	–	–	–	–	–	–	–	–	–	
200	–	–	–	–	–	–	–	–	–	–	
Carrera [mm]			Diámetro del émbolo: 25 mm			Diámetro del émbolo: 32 mm			Diámetro del émbolo: 40 mm		
10	–	–	–	–	–	–	–	–	–	–	
20	170 847	DFM-25-20-P-A-GF	170 854	DFM-32-20-P-A-GF	–	–	–	–	–	–	
25	170 848	DFM-25-25P-A-GF	170 855	DFM-32-25-P-A-GF	170 864	DFM-40-25-P-A-GF	–	–	–	–	
30	170 849	DFM-25-30-P-A-GF	170 856	DFM-32-30-P-A-GF	–	–	–	–	–	–	
40	170 850	DFM-25-40-P-A-GF	170 857	DFM-32-40-P-A-GF	–	–	–	–	–	–	
50	170 851	DFM-25-50-P-A-GF	170 858	DFM-32-50-P-A-GF	170 865	DFM-40-50-P-A-GF	170 866	DFM-40-80-P-A-GF	170 867	DFM-40-100-P-A-GF	
80	170 852	DFM-25-80-P-A-GF	170 859	DFM-32-80-P-A-GF	170 868	DFM-40-125-P-A-GF	170 869	DFM-40-160-P-A-GF	170 870	DFM-40-200-P-A-GF	
100	170 853	DFM-25-100-P-A-GF	170 860	DFM-32-100-P-A-GF	–	–	–	–	–	–	
125	–	–	170 861	DFM-32-125-P-A-GF	–	–	–	–	–	–	
160	–	–	170 862	DFM-32-160-P-A-GF	–	–	–	–	–	–	
200	–	–	170 863	DFM-32-200-P-A-GF	–	–	–	–	–	–	
Carrera [mm]			Diámetro del émbolo: 50 mm			Diámetro del émbolo: 63 mm			Diámetro de émbolo: 80 mm		
10	–	–	–	–	–	–	–	–	–	–	
20	–	–	–	–	–	–	–	–	–	–	
25	170 871	DFM-50-25-P-A-GF	170 878	DFM-63-25-P-A-GF	170 885	DFM-80-25-P-A-GF	–	–	–	–	
30	–	–	–	–	–	–	–	–	–	–	
40	–	–	–	–	–	–	–	–	–	–	
50	170 872	DFM-50-50-P-A-GF	170 879	DFM-63-50-P-A-GF	170 886	DFM-80-50-P-A-GF	170 887	DFM-80-80-P-A-GF	170 888	DFM-80-100-P-A-GF	
80	170 873	DFM-50-80-P-A-GF	170 880	DFM-63-80-P-A-GF	170 889	DFM-80-125-P-A-GF	170 890	DFM-80-160-P-A-GF	170 891	DFM-80-200-P-A-GF	
100	170 874	DFM-50-100-P-A-GF	170 881	DFM-63-100-P-A-GF	–	–	–	–	–	–	
125	170 875	DFM-50-125-P-A-GF	170 882	DFM-63-125-P-A-GF	–	–	–	–	–	–	
160	170 876	DFM-50-160-P-A-GF	170 883	DFM-63-160-P-A-GF	–	–	–	–	–	–	
200	170 877	DFM-50-200-P-A-GF	170 884	DFM-63-200-P-A-GF	–	–	–	–	–	–	
Carrera [mm]			Diámetro del émbolo: 100 mm								
10	–	–									
20	–	–									
25	170 892	DFM-100-25-P-A-GF									
30	–	–									
40	–	–									
50	170 893	DFM-100-50-P-A-GF									
80	170 894	DFM-100-80-P-A-GF									
100	170 895	DFM-100-100-P-A-GF									
125	170 896	DFM-100-125-P-A-GF									
160	170 897	DFM-100-160-P-A-GF									
200	170 898	DFM-100-200-P-A-GF									

Cilindros guiados DFM

Hoja de datos

Referencias: guía de rodamiento de bolas KF												
Nº de art. Tipo			Nº de art. Tipo			Nº de art. Tipo						
Carrera [mm]			Diámetro del émbolo: 12 mm			Diámetro del émbolo: 16 mm			Diámetro del émbolo: 20 mm			
10	170 899	DFM-12-10-P-A-KF	170 907	DFM-16-10-P-A-KF	–	–	170 915	DFM-20-20-P-A-KF	–	–	–	
20	170 900	DFM-12-20-P-A-KF	170 908	DFM-16-20-P-A-KF	170 916	DFM-20-25-P-A-KF	170 917	DFM-20-30-P-A-KF	170 918	DFM-20-40-P-A-KF	170 919	DFM-20-50-P-A-KF
25	170 901	DFM-12-25-P-A-KF	170 909	DFM-16-25-P-A-KF	170 910	DFM-16-30-P-A-KF	170 920	DFM-20-80-P-A-KF	170 921	DFM-20-100-P-A-KF	–	–
30	170 902	DFM-12-30-P-A-KF	170 911	DFM-16-40-P-A-KF	–	–	–	–	–	–	–	–
40	170 903	DFM-12-40-P-A-KF	170 912	DFM-16-50-P-A-KF	–	–	–	–	–	–	–	–
50	170 904	DFM-12-50-P-A-KF	170 913	DFM-16-80-P-A-KF	–	–	–	–	–	–	–	–
80	170 905	DFM-12-80-P-A-KF	170 914	DFM-16-100-P-A-KF	–	–	–	–	–	–	–	–
100	170 906	DFM-12-100-P-A-KF	–	–	–	–	–	–	–	–	–	–
125	–	–	–	–	–	–	–	–	–	–	–	–
160	–	–	–	–	–	–	–	–	–	–	–	–
200	–	–	–	–	–	–	–	–	–	–	–	–
Carrera [mm]			Diámetro del émbolo: 25 mm			Diámetro del émbolo: 32 mm			Diámetro del émbolo: 40 mm			
10	–	–	170 922	DFM-25-20-P-A-KF	170 929	DFM-32-20-P-A-KF	–	–	–	–	–	–
20	170 923	DFM-25-25-P-A-KF	170 930	DFM-32-25-P-A-KF	170 931	DFM-32-30-P-A-KF	170 939	DFM-40-25-P-A-KF	–	–	–	–
25	170 924	DFM-25-30-P-A-KF	170 932	DFM-32-40-P-A-KF	170 933	DFM-32-50-P-A-KF	170 940	DFM-40-50-P-A-KF	170 941	DFM-40-80-P-A-KF	170 942	DFM-40-100-P-A-KF
30	170 925	DFM-25-40-P-A-KF	170 934	DFM-32-80-P-A-KF	170 935	DFM-32-100-P-A-KF	170 943	DFM-40-125-P-A-KF	170 944	DFM-40-160-P-A-KF	170 945	DFM-40-200-P-A-KF
40	170 926	DFM-25-50-P-A-KF	170 936	DFM-32-125-P-A-KF	170 937	DFM-32-160-P-A-KF	–	–	–	–	–	–
50	170 927	DFM-25-80-P-A-KF	170 938	DFM-32-200-P-A-KF	–	–	–	–	–	–	–	–
80	170 928	DFM-25-100-P-A-KF	–	–	–	–	–	–	–	–	–	–
100	–	–	–	–	–	–	–	–	–	–	–	–
125	–	–	–	–	–	–	–	–	–	–	–	–
160	–	–	–	–	–	–	–	–	–	–	–	–
200	–	–	–	–	–	–	–	–	–	–	–	–
Carrera [mm]			Diámetro del émbolo: 50 mm			Diámetro del émbolo: 63 mm			Diámetro de émbolo: 80 mm			
10	–	–	170 946	DFM-50-25-P-A-KF	170 953	DFM-63-25-P-A-KF	170 960	DFM-80-25-P-A-KF	–	–	–	–
20	–	–	–	–	170 954	DFM-63-50-P-A-KF	170 961	DFM-80-50-P-A-KF	–	–	–	–
25	–	–	–	–	170 955	DFM-63-80-P-A-KF	170 962	DFM-80-80-P-A-KF	–	–	–	–
30	–	–	–	–	170 956	DFM-63-100-P-A-KF	170 963	DFM-80-100-P-A-KF	–	–	–	–
40	–	–	–	–	170 957	DFM-63-125-P-A-KF	170 964	DFM-80-125-P-A-KF	–	–	–	–
50	170 947	DFM-50-50-P-A-KF	–	–	170 958	DFM-63-160-P-A-KF	170 965	DFM-80-160-P-A-KF	–	–	–	–
80	170 948	DFM-50-80-P-A-KF	–	–	170 959	DFM-63-200-P-A-KF	170 966	DFM-80-200-P-A-KF	–	–	–	–
100	170 949	DFM-50-100-P-A-KF	–	–	–	–	–	–	–	–	–	–
125	170 950	DFM-50-125-P-A-KF	–	–	–	–	–	–	–	–	–	–
160	170 951	DFM-50-160-P-A-KF	–	–	–	–	–	–	–	–	–	–
200	170 952	DFM-50-200-P-A-KF	–	–	–	–	–	–	–	–	–	–
Carrera [mm]			Diámetro del émbolo: 100 mm									
10	–	–	–	–	–	–	–	–	–	–	–	–
20	–	–	–	–	–	–	–	–	–	–	–	–
25	170 967	DFM-100-25-P-A-KF	–	–	–	–	–	–	–	–	–	–
30	–	–	–	–	–	–	–	–	–	–	–	–
40	–	–	–	–	–	–	–	–	–	–	–	–
50	170 968	DFM-100-50-P-A-KF	–	–	–	–	–	–	–	–	–	–
80	170 969	DFM-100-80-P-A-KF	–	–	–	–	–	–	–	–	–	–
100	170 970	DFM-100-100-P-A-KF	–	–	–	–	–	–	–	–	–	–
125	170 971	DFM-100-125-P-A-KF	–	–	–	–	–	–	–	–	–	–
160	170 972	DFM-100-160-P-A-KF	–	–	–	–	–	–	–	–	–	–
200	170 973	DFM-100-200-P-A-KF	–	–	–	–	–	–	–	–	–	–

Cilindros guiados DFM-B

Cuadro general de periféricos

FESTO

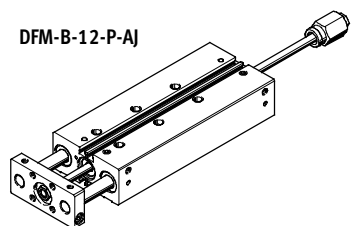
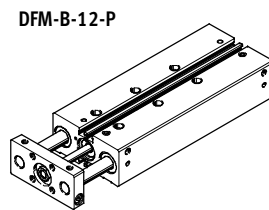
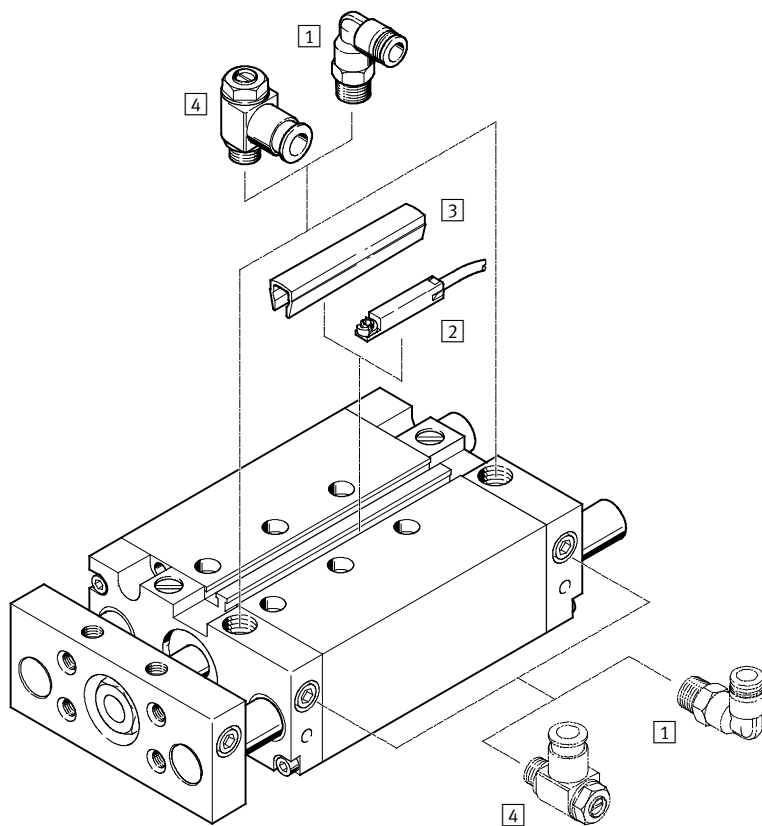

Variantes

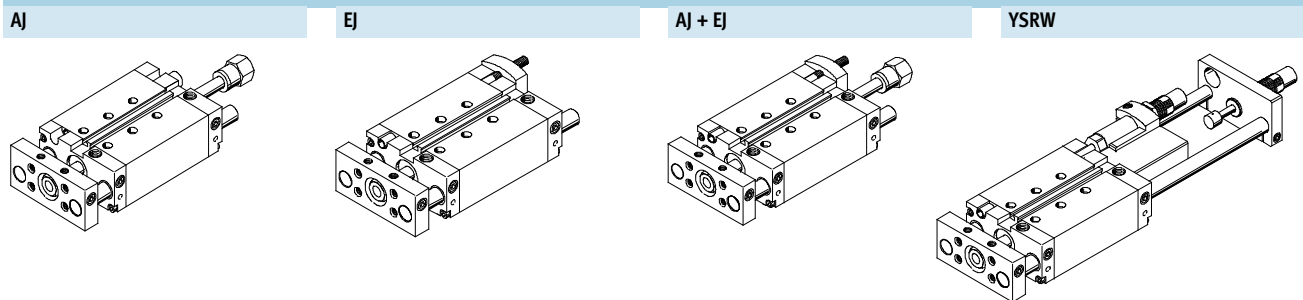

Accesorios		
	Descripción resumida	→ Página/Internet
1	Racor rápido roscado QS	quick star
2	Detectores de posición SME-/SMT-8/10	61
3	Tapa para ranuras ABP-5-S	62
4	Válvula reguladora de caudal GRLA	62
-	Casquillos para centrar ZBH	4 ó 6 unidades incluidas en el suministro
		60

- Importante
 Los detectores de proximidad SM...O-8E no pueden utilizarse con DFM-B.

Cilindros guiados DFM-B

Código para el pedido

DFM - 50 - 80 - B - P - A - GF - S6 - AJ - ZUB - 10S - G

Tipo

DFM	Cilindro guiado
-----	-----------------

Diámetro del émbolo [mm]

Carrera [mm]

Generación

B	Serie
---	-------

Amortiguación

P	Anillos y discos elásticos en ambos lados
PPV	Amortiguación neumática regulable en ambos lados
YSRW	Amortiguador autorregulable en ambos lados

Detección de posiciones

A	Para detectores de proximidad
---	-------------------------------

Guía

GF	Guía de deslizamiento
KF	Guías con rodamiento de bolas

Variante

S6	Juntas termorresistentes hasta máx. 120 °C
----	--

Ajuste fino

AJ	Posición final con vástago extendido
EJ	Posición final con vástago retraído

Accesorios

ZUB	Incluidos sueltos en el suministro
-----	------------------------------------

Tapa para ranuras

...S	Ranura para detectores
------	------------------------

Detectores de posición

...G	Con cable de 2,5 m
...I	Sin contacto, con cable de 2,5 m

Cilindros guiados DFM-B



Hoja de datos

FESTO

Función

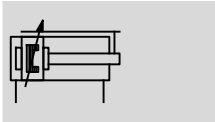
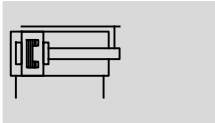
 www.festo.com



-  - Diámetro
12 ... 63 mm
-  - Carrera
10 ... 400 mm

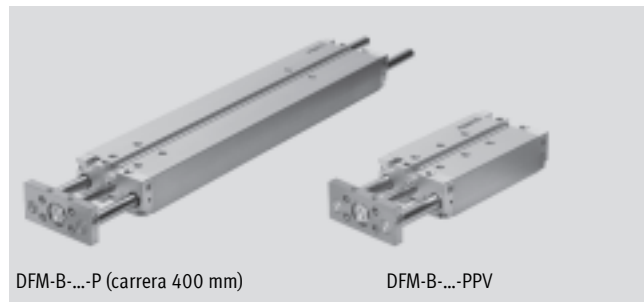

DFM-B-...-P (carrera 400 mm)

DFM-B-...-PPV

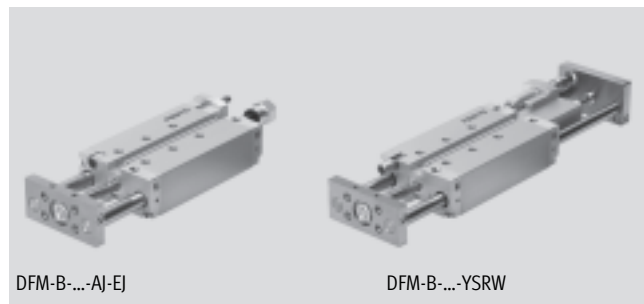

DFM-B-...-AJ-EJ

DFM-B-...-YSRW

Datos técnicos generales								
Diámetro del émbolo	12	16	20	25	32	40	50	63
Conexión neumática	M5	M5	M5	G $\frac{1}{8}$	G $\frac{1}{8}$	G $\frac{1}{8}$	G $\frac{1}{4}$	G $\frac{1}{4}$
Fluido de trabajo	Aire comprimido según ISO 8573-1:2010 [7:4:4]							
Nota sobre el fluido de trabajo/mando	Es posible el funcionamiento con aire comprimido lubricado (lo cual requiere seguir utilizando aire lubricado)							
Presión de funcionamiento [bar]	2 ... 10	2 ... 10	2 ... 10	1,5 ... 10	1,5 ... 10	1,5 ... 10	1 ... 10	1 ... 10
Construcción	Émbolo							
	Vástago							
	Barras de guía con yugo							
Amortiguación	Anillos y discos elásticos en ambos lados							
	-	Amortiguación neumática regulable en ambos lados						
	-	-	Ajuste automático en ambos lados					
Carrera de amortiguación (PPV) [mm]	-	12	15	15	16	17	19	19
Detección de posiciones	Para detectores de proximidad							
Tipo de fijación	Mediante taladros							
	Con rosca interior							
Posición de montaje	Indistinta							
Antigiro/Guía	Barra de guía con estribo; guía de deslizamiento o de rodamiento de bolas							
Variantes AJ, EJ y YSRW								
Margen de ajuste [mm]	0 ... 10							
Variante YSRW con amortiguador								
Precisión de repetición [mm]	-	-	Máx. 0,05					

⚠ - Importante: Este producto cumple con los estándares ISO 1179-1 e ISO 228-1

Cilindros guiados DFM-B

Hoja de datos

Condiciones del entorno				
	Guía de deslizamiento GF	Guía de rodamiento de bolas KF	Variante YSRW con amortiguador	S6
Temperatura ambiente ¹⁾ [°C]	-20 ... +80	-5 ... +60	0 ... +60	0 ... +120
Clase de resistencia a la corrosión ²⁾	2	-	-	2
ATEX	Tipos especiales → www.festo.com			

1) Tener en cuenta las condiciones de funcionamiento de los detectores

2) Clase de resistencia a la corrosión 1 según norma de Festo 940 070

Válida para piezas expuestas a peligro de corrosión. Protección para transporte y almacenamiento. Piezas con superficies sin fines decorativos, por ejemplo, por encontrarse en el interior o detrás de tapas o recubrimientos

Clase de resistencia a la corrosión 2 según norma de Festo 940 070

Válida para piezas expuestas a gran peligro de corrosión. Piezas exteriores en contacto directo con sustancias usuales en entornos industriales, tales como disolventes, detergentes o lubricantes, con superficies principalmente decorativas

Velocidades [m/s]								
Diámetro del émbolo	12	16	20	25	32	40	50	63
Amortiguación P, ajuste fino de la carrera AJ y EJ								
Velocidad máxima en avance, en retroceso	0,8	0,8	0,8	0,8	0,8	0,8	0,6	0,6
Amortiguación P, guía deslizante GF con la S6								
Velocidad máxima en avance, en retroceso	0,5	0,5	0,5	0,5	0,5	0,5	0,4	0,4
Amortiguación PPV, YSRW, PPV S6								
Velocidad máxima en avance, en retroceso	-	1,5	1,5	1,5	1,5	1,5	1	1

Fuerzas [N]								
Diámetro del émbolo	12	16	20	25	32	40	50	63
Amortiguación P, PPV, YSRW, ajuste fino de la carrera EJ								
Fuerza teórica con 6 bar, Avance	68	121	188	295	482	754	1 178	1 870
Fuerza teórica con 6 bar, Retroceso	51	90	141	247	415	686	1 057	1 750
Ajuste fino de la carrera AJ y AJ+EJ								
Fuerza teórica con 6 bar, Avance	51	90	141	247	415	686	1 057	1 750
Fuerza teórica con 6 bar, Retroceso	51	90	141	247	415	686	1 057	1 750

Cilindros guiados DFM-B

Hoja de datos

Energía de impacto [J]								
Diámetro del émbolo	12	16	20	25	32	40	50	63
Amortiguación P								
Energía máx. de impacto en las posiciones finales	0,09	0,15	0,2	0,35	0,40	0,7	1,0	1,3
Energía máx. de impacto en S6 las posiciones finales	0,035	0,075	0,1	0,15	0,2	0,35	0,5	0,65
Amortiguación YSRW								
Capacidad máxima de absorción de energía, por carrera	-	-	4	8	12	35	35	70
Capacidad máxima de absorción de energía, por hora	-	-	21 000	30 000	41 000	68 000	68 000	100 000

Velocidad de impacto admisible:
$$v_{adm.} = \sqrt{\frac{2 \times E_{adm.}}{m_{propia} + m_{carga}}}$$

Masa máxima admisible:
$$m_{carga} = \frac{2 \times E_{adm.}}{v^2} - m_{propia}$$

$v_{adm.}$ Velocidad de impacto admisible
 $E_{adm.}$ Energía máx. de impacto
 m_{propia} Masa móvil (actuador)
 m_{carga} Carga útil a mover

 Importante
 Estos valores son valores máximos posibles. Debe tenerse en cuenta la energía máxima admisible del impacto.

DFM-B con guía deslizante GF, amortiguación P, PPV								
Carrera [mm]	Diámetro del émbolo [mm]							
	12	16	20	25	32	40	50	63
Peso del producto [g]								
10	385	621	-	-	-	-	-	-
20	432	680	1 026	1 474	2 163	-	-	-
25	452	706	1 068	1 530	2 238	2 606	4 290	5 568
30	476	736	1 109	1 586	2 337	-	-	-
40	523	795	1 215	1 726	2 489	-	-	-
50	570	854	1 298	1 838	2 640	3 047	5 019	6 457
80	712	1 033	1 572	2 218	3 210	3 663	5 909	7 503
100	803	1 148	1 733	2 435	3 502	3 981	6 376	8 116
125	962	1 352	2 000	2 800	4 018	4 534	7 151	9 050
160	1 128	1 560	2 293	3 193	4 549	5 118	8 017	10 137
200	1 318	1 797	2 628	3 642	5 158	5 786	9 007	11 379
250	-	-	3 237	4 430	6 259	6 962	10 813	13 509
320	-	-	3 823	5 215	7 322	8 129	12 545	15 682
400	-	-	4 493	6 113	8 537	9 462	14 525	18 165
Masa móvil [g]								
10	201	283	-	-	-	-	-	-
20	216	302	506	715	1 147	-	-	-
25	223	312	520	734	1 176	1 305	2 217	2 640
30	230	322	534	753	1 230	-	-	-
40	245	342	586	823	1 289	-	-	-
50	260	362	615	861	1 347	1 476	2 567	2 990
80	304	423	724	1 022	1 644	1 776	3 002	3 426
100	333	463	781	1 098	1 764	1 893	3 189	3 613
125	420	579	917	1 289	2 059	2 188	3 586	4 009
160	472	649	1 016	1 422	2 264	2 393	3 913	4 336
200	530	730	1 129	1 573	2 499	2 627	4 286	4 710
250	-	-	1 489	2 017	3 164	3 293	5 351	5 774
320	-	-	1 688	2 283	3 574	3 703	6 005	6 428
400	-	-	1 914	2 587	4 042	4 171	6 752	7 176

Cilindros guiados DFM-B

Hoja de datos

DFM-B con guía deslizante GF, amortiguación P, PPV, variante S6								
Carrera [mm]	Diámetro del émbolo [mm]							
	12	16	20	25	32	40	50	63
Peso del producto [g]								
0	283	488	745	1 080	1 594	1 847	3 124	3 992
10	328	548	–	–	–	–	–	–
20	376	607	907	1 298	1 889	–	–	–
25	395	633	949	1 354	1 964	2 257	3 735	4 762
30	419	663	990	1 410	2 063	–	–	–
40	466	722	1 096	1 550	2 215	–	–	–
50	514	781	1 179	1 662	2 366	2 698	4 464	5 651
80	656	959	1 452	2 042	2 936	3 314	5 354	6 696
100	747	1 074	1 614	2 259	3 228	3 632	5 821	7 310
125	905	1 279	1 880	2 624	3 745	4 186	6 596	8 244
160	1 072	1 486	2 173	3 017	4 276	4 770	7 462	9 331
200	1 261	1 724	2 508	3 466	4 884	5 437	8 452	10 573
250	–	–	3 118	4 254	5 985	6 613	10 258	12 703
320	–	–	3 704	5 039	7 048	7 780	11 990	14 876
400	–	–	4 374	5 937	8 264	9 114	19 970	17 359
Masa móvil [g]								
0	130	188	329	463	755	810	1 428	1 601
10	145	208	–	–	–	–	–	–
20	159	229	386	539	873	–	–	–
25	167	239	400	558	902	956	1 662	1 834
30	174	249	414	577	956	–	–	–
40	188	269	467	647	1 015	–	–	–
50	203	289	495	685	1 073	1 127	2 012	2 184
80	247	349	604	847	1 373	1 427	2 447	2 620
100	276	389	661	922	1 490	1 544	2 634	2 806
125	364	506	797	1 113	1 785	1 840	3 031	3 203
160	415	576	896	1 246	1 990	2 045	3 358	3 530
200	474	657	1 010	1 397	2 225	2 279	3 731	3 904
250	–	–	1 370	1 842	2 890	2 944	4 796	4 968
320	–	–	1 568	2 107	3 300	3 354	5 450	5 622
400	–	–	1 794	2 411	3 768	3 823	6 197	6 370

Cilindros guiados DFM-B

Hoja de datos

DFM-B con guía de rodamiento de bolas KF, amortiguación P, PPV								
Carrera [mm]	Diámetro del émbolo [mm]							
	12	16	20	25	32	40	50	63
Peso del producto [g]								
10	345	543	–	–	–	–	–	–
20	388	596	935	1 395	1 932	–	–	–
25	405	619	974	1 447	1 998	2 366	3 907	5 185
30	427	647	1 012	1 499	2 079	–	–	–
40	470	700	1 105	1 624	2 213	–	–	–
50	513	754	1 181	1 729	2 346	2 753	4 523	5 961
80	641	916	1 428	2 074	2 817	3 270	5 272	6 865
100	723	1 020	1 577	2 276	3 073	3 552	5 682	7 423
125	852	1 190	1 809	2 599	3 490	4 006	6 327	8 226
160	1 002	1 378	2 079	2 966	3 958	4 526	7 094	9 214
200	1 174	1 593	2 388	3 384	4 494	5 121	7 971	10 343
250	–	–	2 905	4 073	5 369	6 072	9 419	12 115
320	–	–	3 445	4 805	6 305	7 112	10 953	14 091
400	–	–	4 063	5 642	7 376	8 301	12 707	16 347
Masa móvil [g]								
10	168	239	–	–	–	–	–	–
20	178	254	437	631	933	–	–	–
25	183	261	447	646	954	1 082	1 830	2 254
30	188	268	458	661	990	–	–	–
40	198	283	498	716	1 030	–	–	–
50	208	297	520	746	1 071	1 199	2 067	2 491
80	238	341	602	873	1 271	1 400	2 361	2 785
100	259	370	646	934	1 352	1 481	2 492	2 915
125	316	452	748	1 083	1 548	1 677	2 758	3 182
160	352	503	824	1 189	1 690	1 819	2 986	3 410
200	392	561	911	1 310	1 852	1 981	3 247	3 671
250	–	–	1 180	1 656	2 291	2 420	3 953	4 377
320	–	–	1 332	1 868	2 575	2 703	4 410	4 833
400	–	–	1 505	2 111	2 899	3 027	4 931	5 355

Cilindros guiados DFM-B

Hoja de datos

FESTO

Pesos adicionales con ajuste fino de la carrera AJ – GF, KF

Al utilizar el ajuste fino de la carrera AJ, deberá tenerse en cuenta adicionalmente el peso que se indica a continuación.

Peso del producto [g], ajuste fino de la carrera AJ (vástago + tope)								
Carrera [mm]	Diámetro del émbolo [mm]							
	12	16	20	25	32	40	50	63
10	55,4	58,8	–	–	–	–	–	–
20	57,6	61	75,6	115,4	185,7	–	–	–
25	58,7	62,1	77,6	118,5	190,2	188,7	350,7	350,5
30	59,9	63,3	79,6	121,6	194,7	–	–	–
40	62,1	65,5	83,6	127,8	203,6	–	–	–
50	64,3	67,7	87,5	134	212,5	211	390,4	390,2
80	71	74,4	99,5	152,6	239,3	237,8	438	437,8
100	75,5	78,9	107,5	165	257,2	255,7	469,8	469,6
125	81,1	84,5	117,3	180,5	279,5	278	509,5	509,3
160	88,9	92,3	131,2	202,5	310,8	309,3	565,1	564,9
200	97,8	101,2	147,1	227	346,5	345	628,6	628,4
250	–	–	167	258,1	391,2	389,7	708,1	707,9
320	–	–	194,8	301,5	453,8	452,3	819,2	819
400	–	–	226,5	351,1	525,2	523,7	946,3	946,1

Masa móvil [g], ajuste fino de la carrera AJ (vástago + tope)								
Carrera [mm]	Diámetro del émbolo [mm]							
	12	16	20	25	32	40	50	63
10	51,5	52,3	–	–	–	–	–	–
20	53,7	54,5	76	116,6	185,9	–	–	–
25	54,8	55,6	78	119,7	190,4	190	351,7	351,7
30	56	56,8	80	122,8	194,9	–	–	–
40	58,2	59	84	129	203,8	–	–	–
50	60,4	61,2	87,9	135,2	212,7	212,7	391,4	391,4
80	67,1	67,9	99,9	153,8	239,5	239,5	439	439
100	71,6	72,4	107,8	166,2	257,4	257,4	470,8	470,8
125	77,2	78	117,7	181,7	279,7	279,7	510,5	510,5
160	85	85,8	131,6	203,4	311	311	566,1	566,1
200	93,9	94,7	147,5	228,2	346,7	346,7	629,6	629,6
250	–	–	167,4	259,3	391,4	391,4	709,1	709,1
320	–	–	195,2	302,7	454	454	820,2	820,2
400	–	–	226,9	352,3	525,4	525,4	947,3	947,3

Cilindros guiados DFM-B

Hoja de datos

Pesos adicionales con ajuste fino de la carrera EJ – GF, KF

Al utilizar el ajuste fino de la carrera EJ, deberá tenerse en cuenta adicionalmente el peso que se indica a continuación.

Peso del producto [g], ajuste fino de la carrera EJ (vástago + tope)						
Carrera [mm]	Diámetro del émbolo [mm]					
	20	25	32	40	50	63
20	55,7	117,1	134,1	–	–	–
25	56,4	119,1	136,1	153,9	302,8	354
30	57,2	121	138	–	–	–
40	58,8	125	142	–	–	–
50	60,3	129	146	163,8	318,3	369,5
80	65	140,9	157,9	175,7	336,9	388,1
100	68,1	148,8	165,8	183,6	349,4	400,6
125	71,9	158,8	175,8	193,6	364,9	416,1
160	77,4	172,7	189,7	207,5	386,6	437,8
200	83,6	188,5	205,5	223,3	411,4	462,6
250	91,3	208,4	225,4	243,2	442,4	493,6
320	102,2	236,2	253,2	271	485,9	537,1
400	114,6	268	285	302,8	535,5	586,7

DFM-B con guía de rodamiento de bolas KF, amortiguación YSRW						
Carrera [mm]	Diámetro del émbolo [mm]					
	20	25	32	40	50	63
Peso del producto [g]						
20	1 684	2 641	3 717	–	–	–
25	1 733	2 707	3 801	4 995	7 594	10 816
30	1 780	2 773	3 884	–	–	–
40	1 874	2 903	4 053	–	–	–
50	1 970	3 035	4 222	5 455	8 275	11 657
80	2 257	3 429	4 720	5 999	9 092	12 629
100	2 444	3 687	5 047	6 352	9 614	13 298
125	2 677	4 008	5 458	6 801	10 294	14 137
160	3 015	4 473	6 050	7 446	11 255	15 319
200	3 401	5 004	6 728	8 183	12 354	16 670
250	3 855	5 641	7 545	9 074	13 700	18 340
320	4 530	6 569	8 730	10 363	15 623	20 704
400	5 302	7 631	10 085	11 837	17 821	23 405
Masa móvil [g]						
20	874	1 323	1 933	–	–	–
25	894	1 350	1 969	2 386	3 735	4 996
30	914	1 378	2 005	–	–	–
40	953	1 432	2 077	–	–	–
50	993	1 487	2 149	2 566	4 021	5 282
80	1 111	1 650	2 365	2 782	4 365	5 625
100	1 190	1 759	2 509	2 926	4 594	5 855
125	1 289	1 896	2 690	3 106	4 880	6 141
160	1 427	2 087	2 942	3 359	5 281	6 542
200	1 585	2 305	3 230	3 647	5 739	7 000
250	1 782	2 578	3 590	4 007	6 312	7 572
320	2 059	2 959	4 095	4 512	7 114	8 374
400	2 375	3 396	4 671	5 088	8 030	9 290

Cilindros guiados DFM-B

Hoja de datos

FESTO

Materiales

Vista en sección

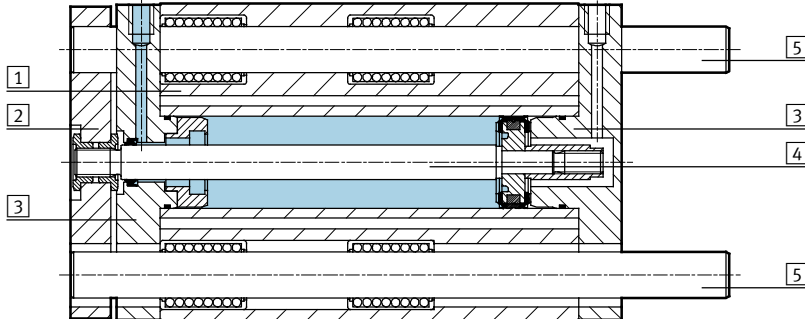

Cilindro guiado	Guía de deslizamiento GF	Guía de rodamiento de bolas KF	S6
1 Cuerpo	Aleación forjada de aluminio anodizado	Aleación forjada de aluminio anodizado	Aleación forjada de aluminio anodizado
2 Yugo	Acero templado	Acero templado	Aleación forjada de aluminio
3 Culatas anterior y posterior	Aleación forjada de aluminio anodizado	Aleación forjada de aluminio anodizado	Aleación forjada de aluminio anodizado
4 Vástago	Acero de aleación fina, inoxidable	Acero de aleación fina, inoxidable	Acero de aleación fina, inoxidable
5 Barras de guía	Acero de aleación fina	Acero templado	Acero de aleación fina
- Juntas estáticas	Caucho nitrílico	Caucho nitrílico	Caucho fluorado
- Juntas dinámicas	Poliuretano	Poliuretano	Caucho fluorado
Calidad del material	Conformidad con RoHS		

Carga útil máxima F [N]

Guía deslizante GF y de rodamiento de bolas KF

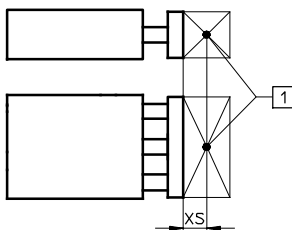

1 Centro de gravedad de la carga útil

Diámetro del émbolo [mm]	XS [mm]	Carrera [mm]														
		10	20	25	30	40	50	80	100	125	160	200	250	320	400	
12	25	GF	53	47	45	43	39	36	28	25	23	20	15	-	-	-
		KF	47	42	40	38	35	32	26	23	20	16	13	-	-	-
16	50	GF	95	86	83	79	73	67	55	49	37	30	25	-	-	-
		KF	75	69	66	64	58	56	51	48	30	21	17	-	-	-
20	50	GF	-	99	96	92	110	103	86	77	71	63	55	47	41	35
		KF	-	80	77	75	91	88	80	75	65	56	47	40	34	29
25	50	GF	-	121	116	112	123	115	96	86	86	76	67	53	45	39
		KF	-	88	86	84	100	97	89	85	80	66	56	46	38	32
32	50	GF	-	188	180	173	161	150	166	150	168	146	127	106	91	78
		KF	-	120	118	116	112	109	134	128	144	135	126	135	125	100
40	50	GF	-	-	180	-	-	150	166	150	168	146	127	106	91	78
		KF	-	-	118	-	-	109	134	128	144	135	126	135	125	100
50	50	GF	-	-	257	-	-	216	234	212	229	200	174	145	124	105
		KF	-	-	182	-	-	168	201	193	211	199	188	179	158	130
63	50	GF	-	-	257	-	-	216	234	212	229	200	174	145	124	105
		KF	-	-	182	-	-	168	201	193	211	199	188	179	158	130

! - Importante

Software de dimensionado GSED

→ www.festo.com

Cilindros guiados DFM-B

Hoja de datos

FESTO

Momento admisible M [Nm]

Guía deslizante GF y de rodamiento de bolas KF

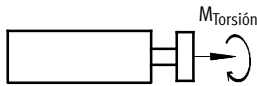

Diámetro del émbolo [mm]		Carrera [mm]													
		10	20	25	30	40	50	80	100	125	160	200	250	320	400
12	GF	1,10	0,95	0,90	0,85	0,80	0,75	0,60	0,50	0,45	0,40	0,30	-	-	-
	KF	0,95	0,85	0,80	0,75	0,70	0,65	0,50	0,45	0,40	0,30	0,25	-	-	-
16	GF	2,20	2,00	1,90	1,80	1,70	1,50	1,30	1,10	0,85	0,70	0,60	-	-	-
	KF	1,70	1,60	1,50	1,45	1,35	1,30	1,20	1,10	0,70	0,50	0,40	-	-	-
20	GF	-	2,90	2,80	2,70	3,20	3,00	2,50	2,20	2,10	1,80	1,60	1,40	1,20	1,00
	KF	-	2,30	2,20	2,15	2,60	2,55	2,30	2,20	1,90	1,60	1,40	1,20	1,00	0,85
25	GF	-	4,15	3,95	3,80	4,20	3,90	3,25	2,90	2,90	2,60	2,30	1,80	1,50	1,30
	KF	-	3,00	2,92	2,85	3,40	3,30	3,02	2,89	2,70	2,20	1,90	1,50	1,30	1,10
32	GF	-	7,30	7,00	6,70	6,20	5,80	6,40	5,80	6,50	5,70	5,00	4,10	3,50	3,00
	KF	-	4,70	4,60	4,55	4,40	4,25	5,25	5,00	5,60	5,25	4,90	5,20	4,80	3,90
40	GF	-	-	7,90	-	-	6,55	7,25	6,55	7,35	6,40	5,55	4,60	4,0	3,40
	KF	-	-	5,20	-	-	4,80	5,90	5,65	6,35	5,95	5,55	5,95	5,50	4,40
50	GF	-	-	14,15	-	-	11,85	12,85	11,65	12,55	11,00	9,60	7,98	6,82	5,78
	KF	-	-	10,00	-	-	9,30	11,00	10,6	11,60	11,00	10,30	9,82	8,67	7,17
63	GF	-	-	15,90	-	-	13,30	14,45	13,10	14,10	12,30	10,70	9,06	7,75	6,56
	KF	-	-	11,30	-	-	10,50	12,50	12,00	13,20	12,40	11,70	11,16	9,85	8,15

Holgura torsional ρ

Guía deslizante GF y guía de rodamiento de bolas KF, retraída, sin carga

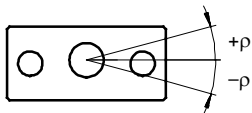

Diámetro del émbolo		12	16	20	25	32	40	50	63
Holgura torsional [°]	GF	0,09	0,09	0,07	0,07	0,06	0,06	0,05	0,05
	KF	0,08	0,08	0,07	0,07	0,05	0,05	0,05	0,05

Cilindros guiados DFM-B

Hoja de datos

Desviación del vástago

Desviación media f_1 debido a la holgura del cojinete en función de la carrera l

DFM-GF con 2 apoyos por barra de guía

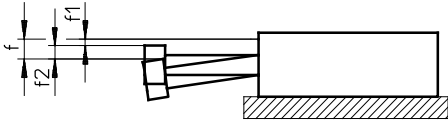

$$f = f_1 + f_2$$

f = desviación total del vástago

f_1 = desviación por holgura del cojinete

f_2 = desviación por fuerza lateral

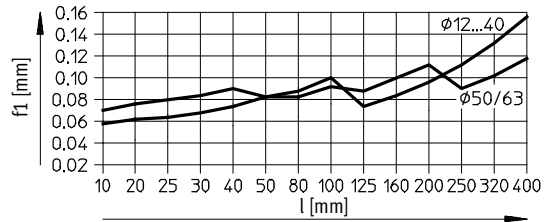

Desvío f_2 debido a la fuerza lateral F en función de la carrera, con guía de deslizamiento GF

Carrera 50 mm

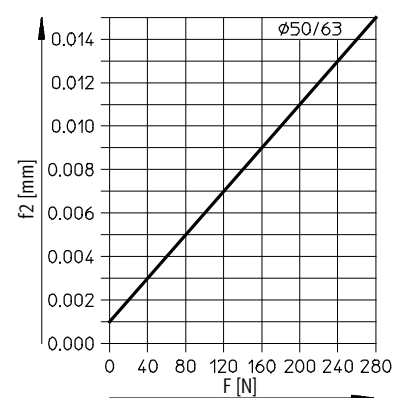
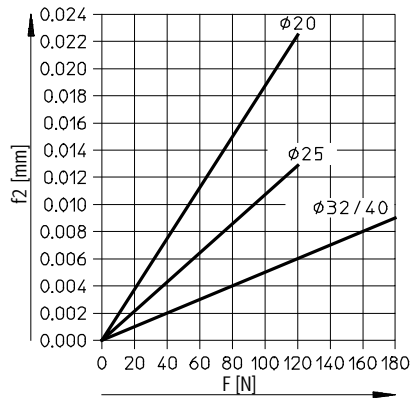
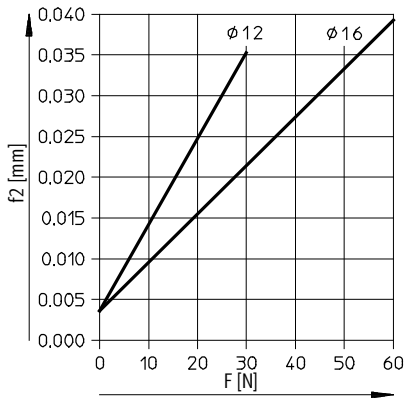

Carrera 100 mm

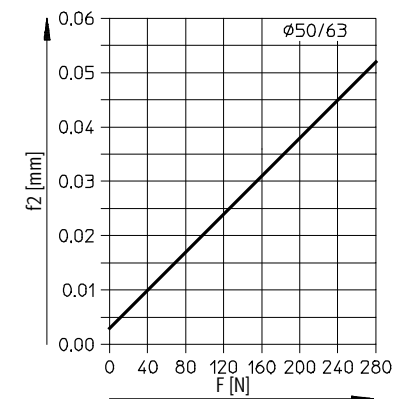
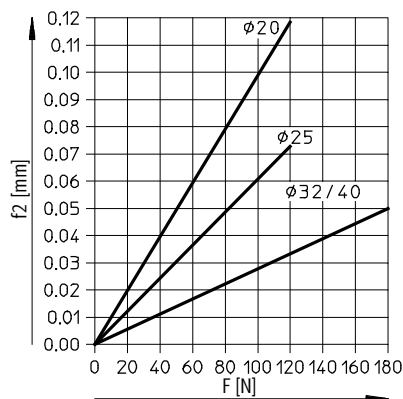
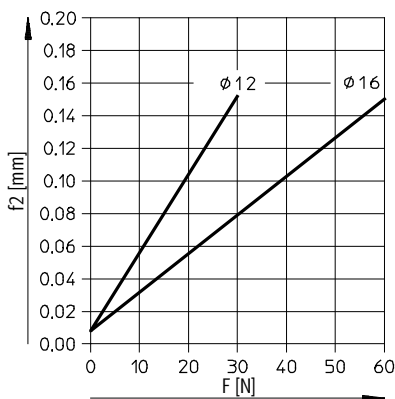

Cilindros guiados DFM-B

Hoja de datos

Desviación del vástago

Desviación media f_1 debido a la holgura del cojinete en función de la carrera l

DFM-GF con 2 apoyos por barra de guía

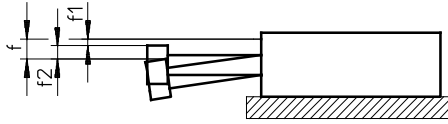

$$f = f_1 + f_2$$

f = desviación total del vástago

f_1 = desviación por holgura del cojinete

f_2 = desviación por fuerza lateral

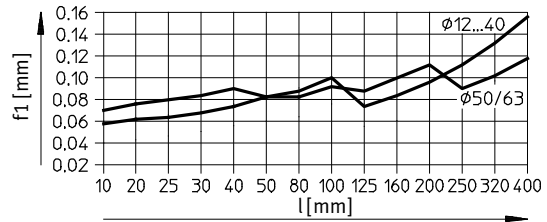

Desvío f_2 debido a la fuerza lateral F en función de la carrera, con guía de deslizamiento GF

Carrera 200 mm

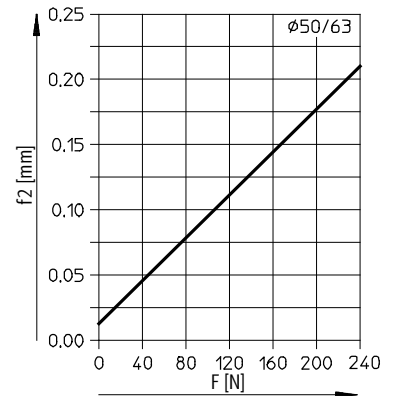
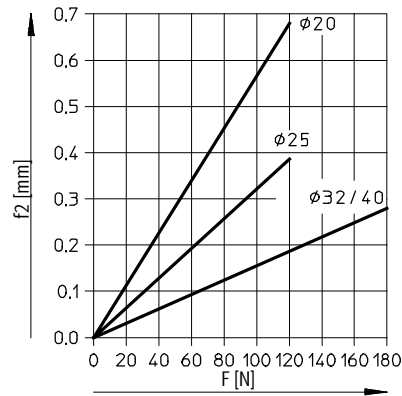
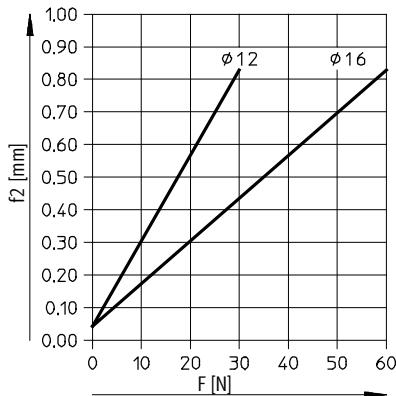

Carrera 400 mm

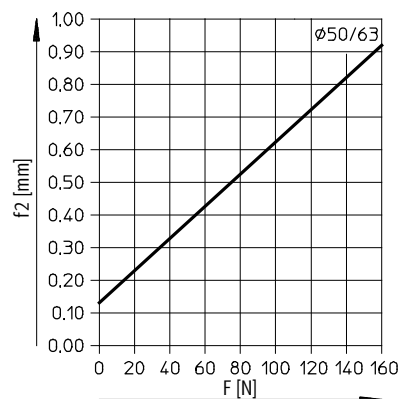
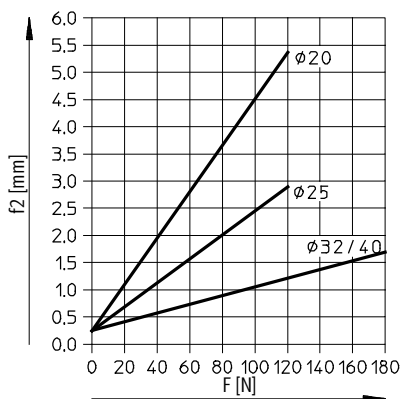

Cilindros guiados DFM-B

Hoja de datos

Desviación del vástago

Desviación media f_1 debido a la holgura del cojinete en función de la carrera l

DFM-KF con 2 apoyos por barra de guía

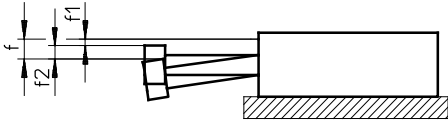

$$f = f_1 + f_2$$

f = desviación total del vástago

f_1 = desviación por holgura del cojinete

f_2 = desviación por fuerza lateral

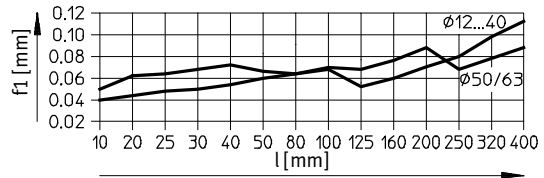

Desvío f_2 debido a la fuerza lateral F en función de la carrera, con guía de rodamiento de bolas KF

Carrera 50 mm

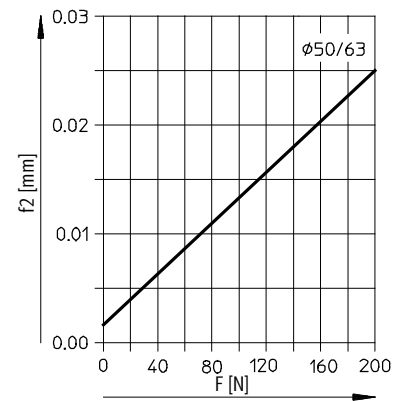
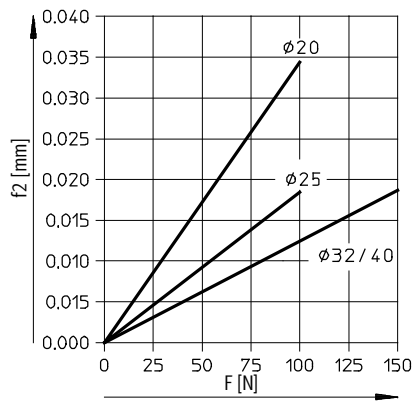
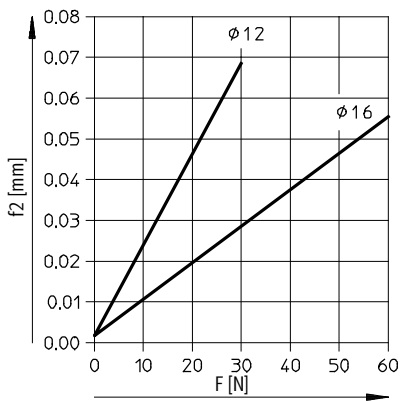

Carrera 100 mm

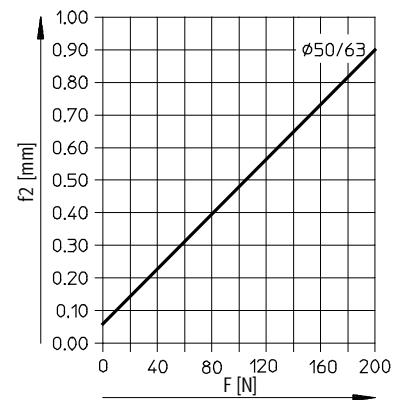
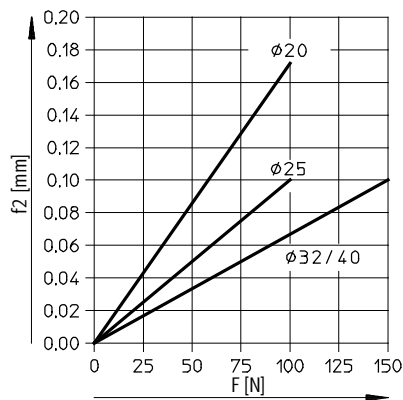
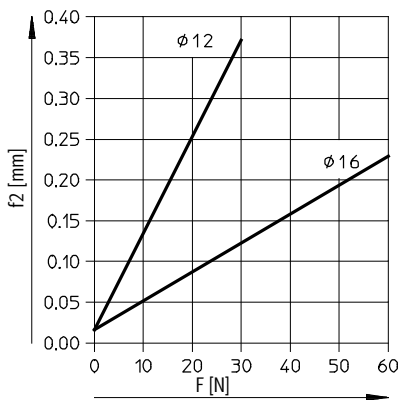

Cilindros guiados DFM-B

Hoja de datos

Desviación del vástago

Desviación media f_1 debido a la holgura del cojinete en función de la carrera l

DFM-KF con 2 apoyos por barra de guía

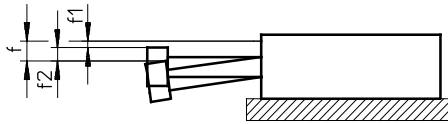

$$f = f_1 + f_2$$

f = desviación total del vástago

f_1 = desviación por holgura del cojinete

f_2 = desviación por fuerza lateral

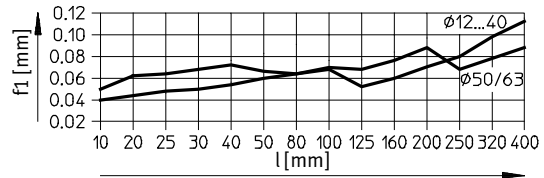

Desvío f_2 debido a la fuerza lateral F en función de la carrera, con guía de rodamiento de bolas KF

Carrera 200 mm

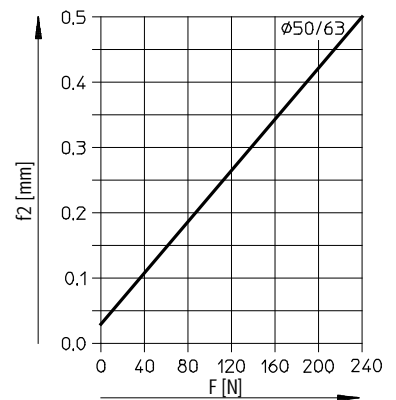
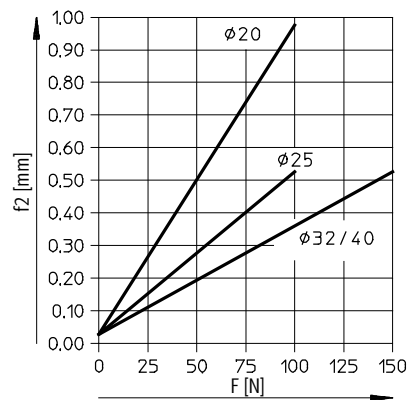
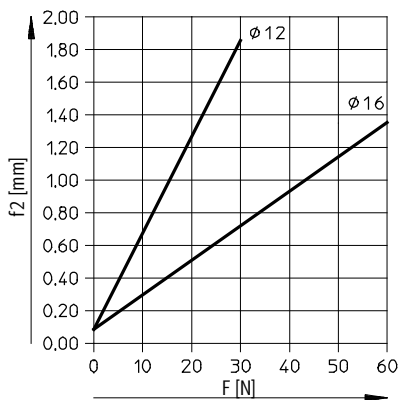

Carrera 400 mm

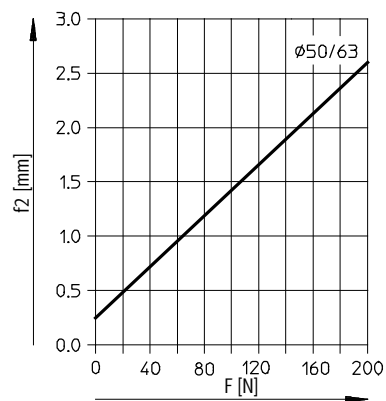
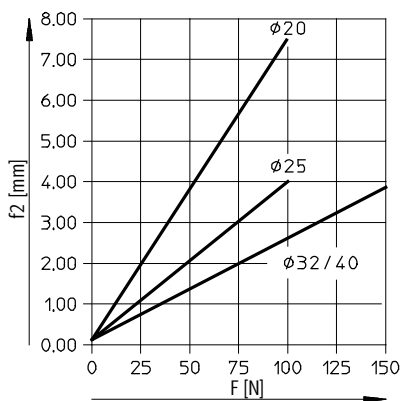

Cilindros guiados DFM-B

Hoja de datos

Utilización como cilindro elevador

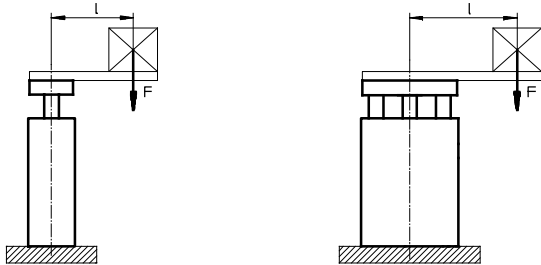

Importante

Otros diagramas → a partir de la página 14.

F = Fuerza longitudinal [N]

l = Palanca [mm]

Carga admisible con guía deslizante GF

Carrera 40 ...400 mm

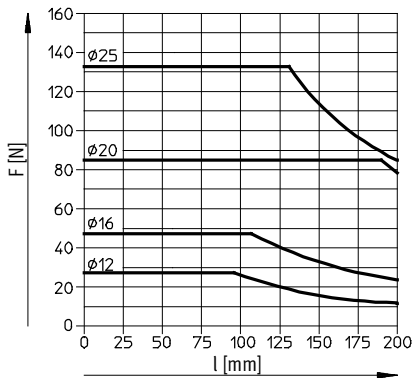

Carrera 250 ...400 mm

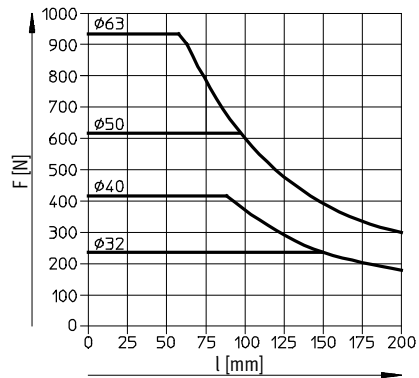

Carga admisible con guía de rodamiento de bolas KF

Carrera 40 ...100 mm

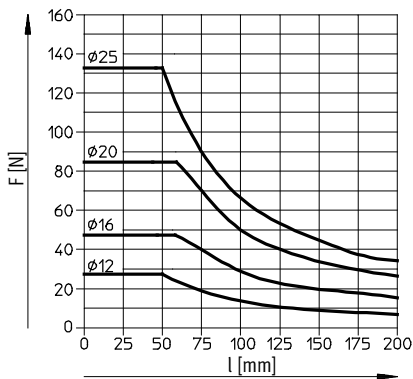

Carrera 125 ...200 mm

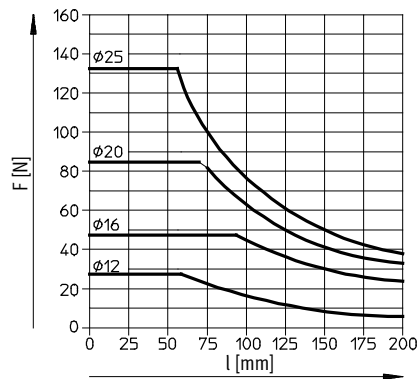

Carrera 250 ...400 mm

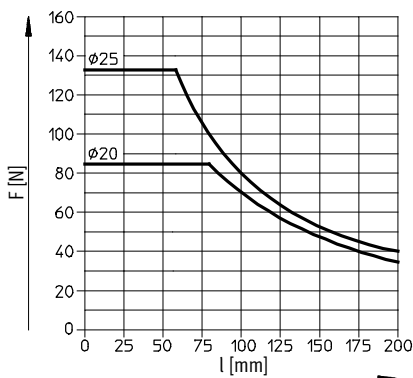

Carrera 200 ...400 mm

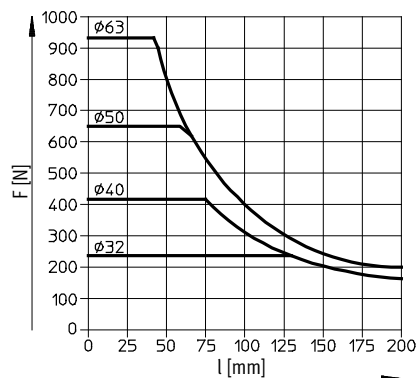

Cilindros guiados DFM-B

Hoja de datos

Carga admisible de la masa m en función de la velocidad admisible v

Funcionamiento horizontal, amortiguación YSRW

DFM-20...-B-YSRW

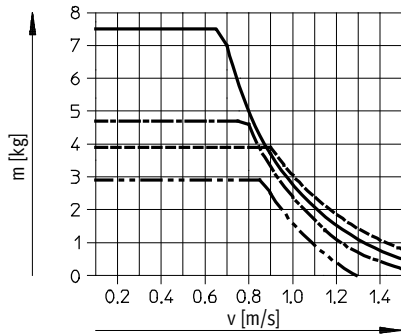

DFM-25...-B-YSRW

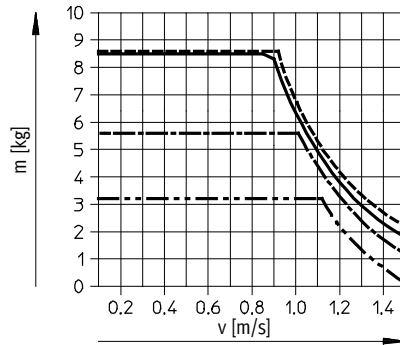

DFM-32...-B-YSRW

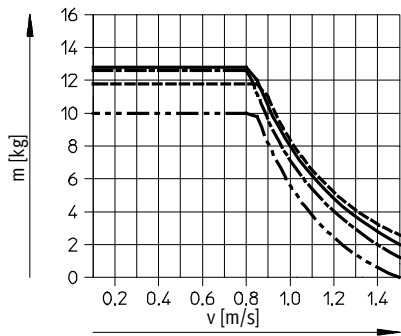

DFM-40...-B-YSRW

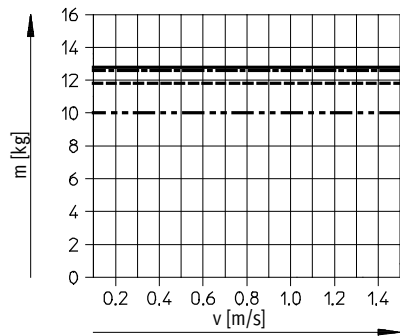

DFM-50...-B-YSRW

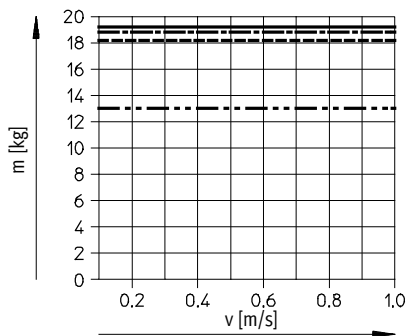

DFM-63...-B-YSRW

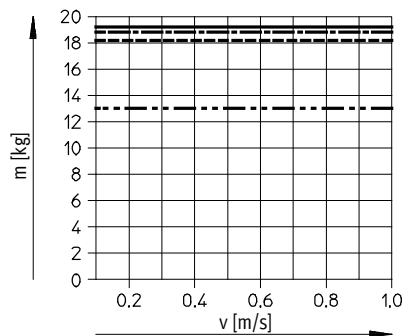

- Carrera de 25 mm
- Carrera de 100 mm
- · - · - Carrera de 200 mm
- · · · · Carrera de 400 mm

Cilindros guiados DFM-B

Hoja de datos

Funcionamiento vertical, amortiguación YSRW

DFM-20...-B-YSRW

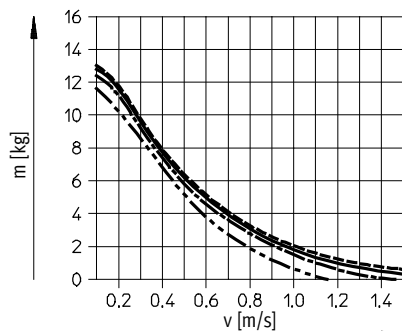

DFM-25...-B-YSRW

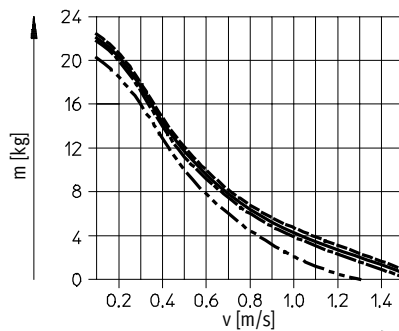

DFM-32...-B-YSRW

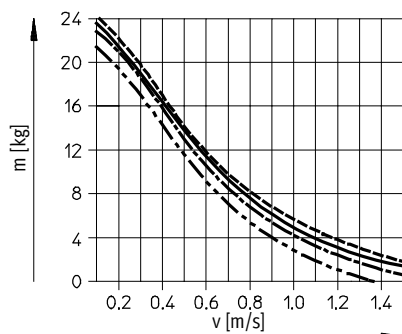

DFM-40...-B-YSRW

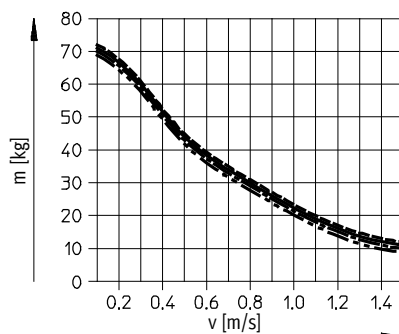

DFM-50...-B-YSRW

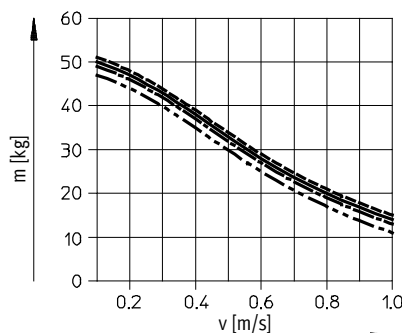

DFM-63...-B-YSRW

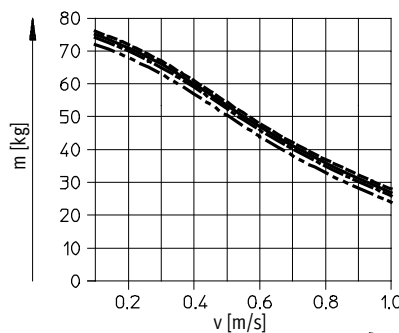

- Carrera de 25 mm
- Carrera de 100 mm
- · - · - Carrera de 200 mm
- Carrera de 400 mm

Cilindros guiados DFM-B

Hoja de datos



Dimensiones

Datos CAD disponibles en www.festo.com

Diámetro del émbolo 12, 16 mm

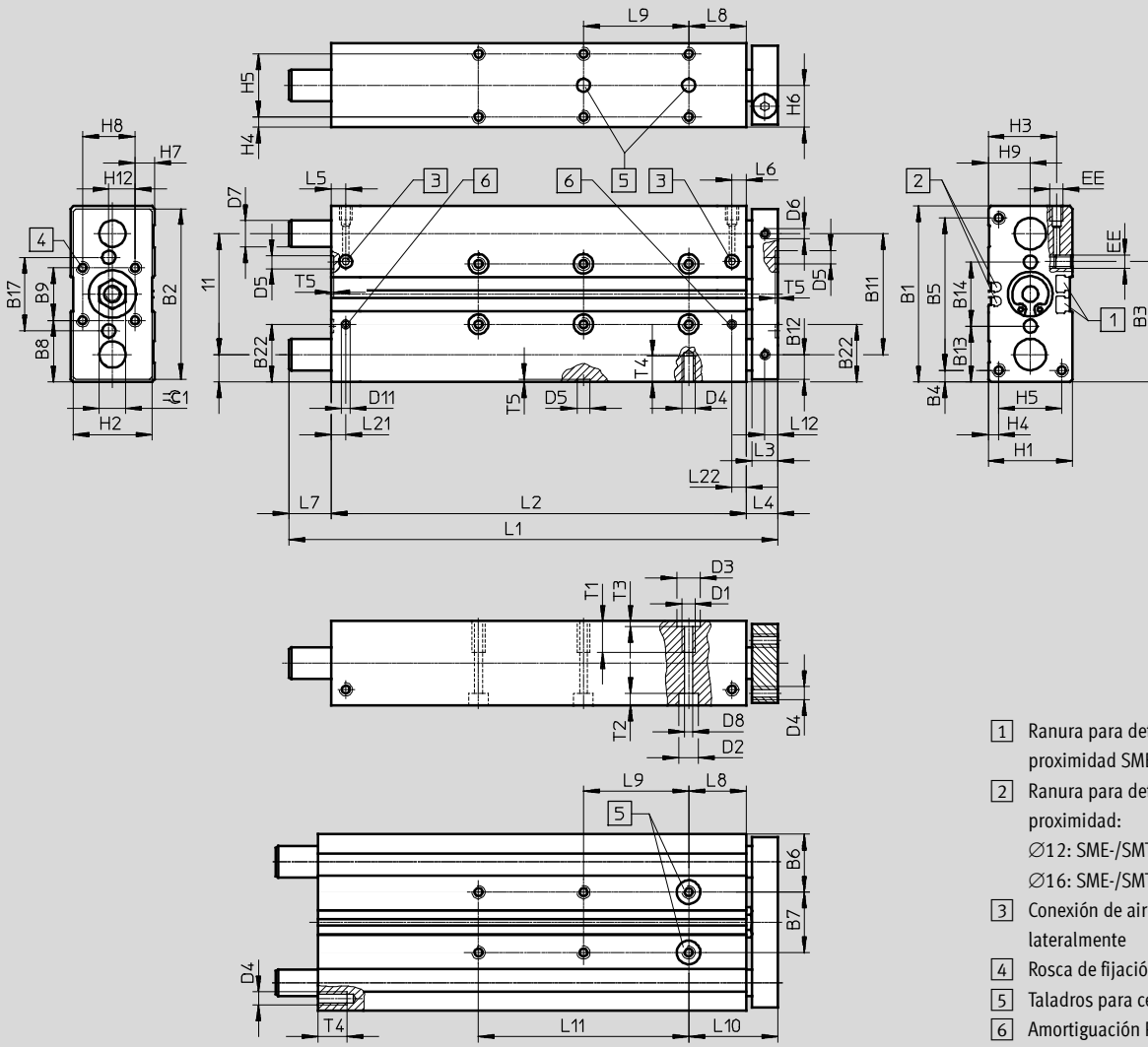

- 1 Ranura para detectores de proximidad SME-/SMT-8
- 2 Ranura para detectores de proximidad:
 Ø12: SME-/SMT-10
 Ø16: SME-/SMT-8
- 3 Conexión de aire arriba o lateralmente
- 4 Rosca de fijación
- 5 Taladros para centrar
- 6 Amortiguación PPV

Ø	B1	B2	B3	B4	B5	B6	B7	B8	B9	B10	B11	B12	B13	B14	B17	B22	D1
[mm]							±0,02 ¹⁾							±0,02 ¹⁾			
12	60	58	40,7	4,5	51	20,5	19	20	20	9,5	41	8,5	19,5	21	25	-	M5
16	67	65	45	4,5	58	22	23	23,5	20	10,5	46	9,5	21,3	24,4	28	22,5	M5

1) Tolerancia entre taladros para centrar

Ø	D2	D3	D4	D5	D6	D7		D8	D11	EE	H1	H2	H3	H4	H5	H6	H7
	Ø	Ø		Ø	Ø	GF	KF	Ø	Ø								
[mm]		H7		H7				H7									
12	8	9	M4	5	M4	10 _{h8}	8 _{h6}	4,3	-	M5	28	26	24	4	20	14	4
16	7,5	9	M5	5	M4	12 _{h8}	10 _{h6}	4,3	3,3	M5	32	30	26,5	4	24	16	7,4

Ø	H8	H9	H12	L3	L4	L5	L6	L8	L10	L12	L21	L22	T1	T2	T3	T4	T5	≈C1
[mm]																		
12	20	14	10	10	13	14,8	11,2	21	34	5	-	-	10	9,4	2,1	8	1,2	10
16	20	16	10	10	12	9,8	9,3	22	34	5	9,8	9,3	12	4,6	2,1	10	1,2	10

Cilindros guiados DFM-B

Hoja de datos

Carrera [mm]	Diámetro del émbolo [mm]									
	12					16				
	L1	L2	L7	L9 $\pm 0,02^{1)}$	L11	L1	L2	L7	L9 $\pm 0,02^{1)}$	L11
10	74	50	11	-	-	80	68	-	-	-
20	84	60	11	-	-	90	78	-	-	-
25	89	65	11	20	-	95	83	-	20	-
30	94	70	11	20	-	100	88	-	20	-
40	104	80	11	20	-	110	98	-	20	-
50	114	90	11	40	-	120	108	-	40	-
80	144	120	11	40	-	150	138	-	40	-
100	164	140	11	40	80	170	158	-	40	80
125	230	165	52	40	80	229	183	34	40	80
160	265	200	52	40	120	264	218	34	40	120
200	305	240	52	40	160	304	258	34	40	160

1) Tolerancia entre taladros para centrar

Importante

Si las barras de guía sobresalen en la parte posterior del cuerpo (→ medida L7), debe compensarse el espacio de montaje correspondientemente en la parte frontal, para que las barras puedan moverse libremente.

En el caso de carreras variable, las dimensiones L1, L2, L7, L9 y L11 corresponden a la carrera estándar siguiente.

Dimensiones Datos CAD disponibles en → www.festo.com

Aj: Ajuste fino de la carrera, posición final en avance
Diámetro 12, 16 mm

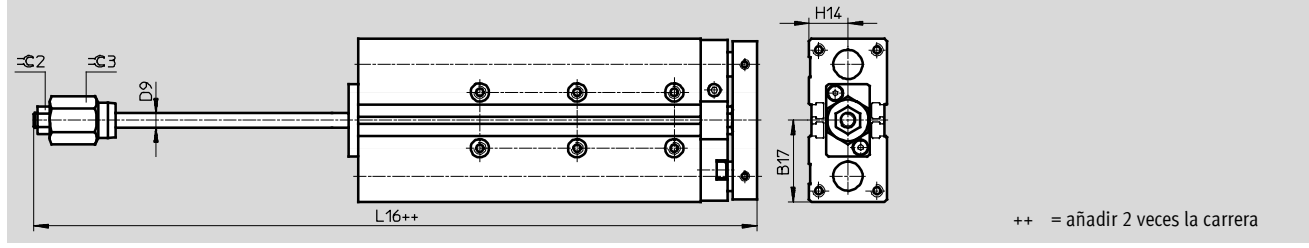

∅	B17	D9 ∅	H14	L16	⊖C2	⊖C3
12	30,5	6	14	90,6	10	17
16	33,5	6	16	107,9	10	17

Cilindros guiados DFM-B

Hoja de datos

FESTO

Dimensiones

Datos CAD disponibles en www.festo.com

Diámetro del émbolo 20 ... 40 mm

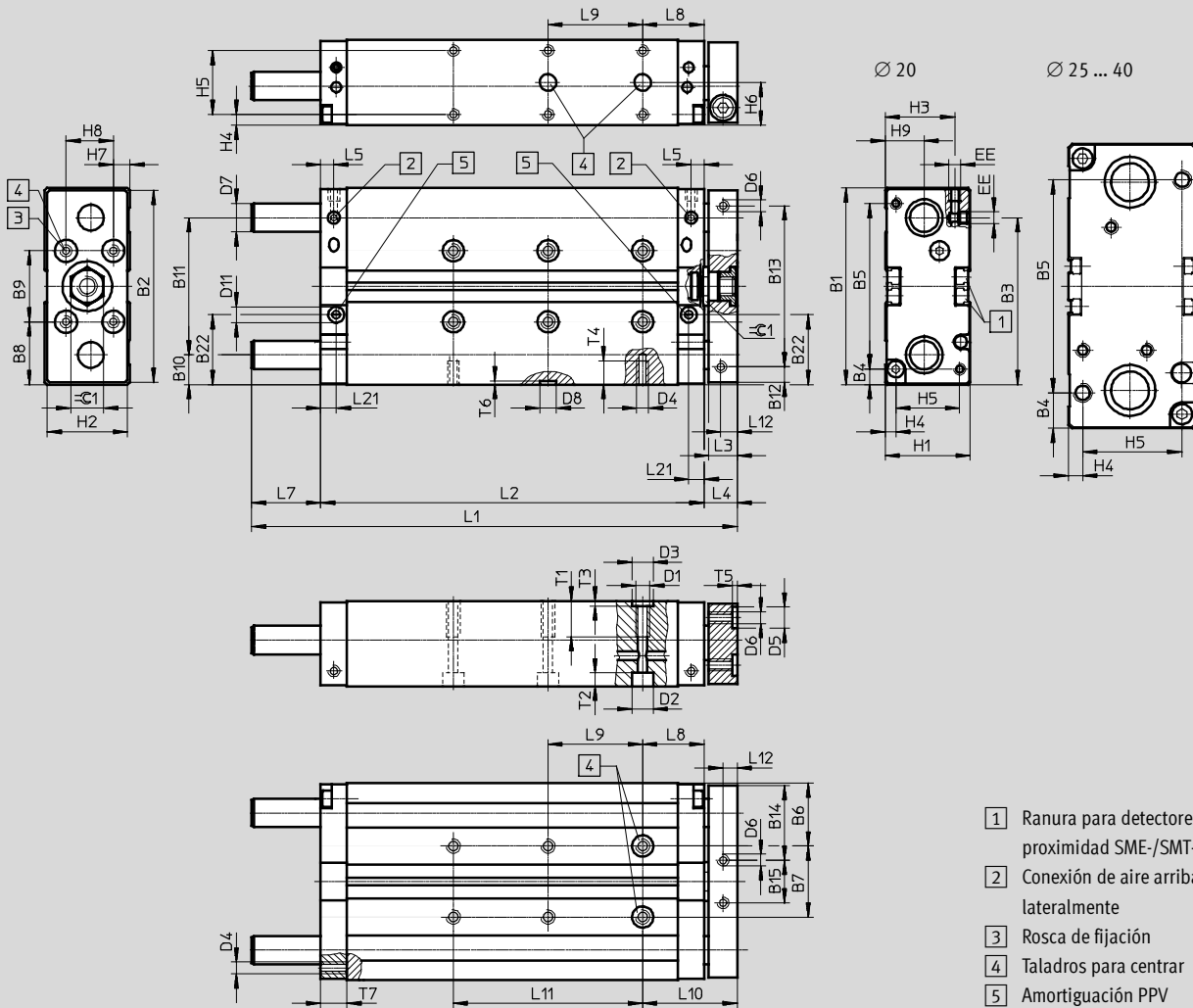

Cilindros guiados DFM-B

Hoja de datos

∅ [mm]	B1	B2	B3	B4	B5	B6	B7 ±0,02 ¹⁾	B8	B9 ±0,02 ¹⁾	B10	B11	B12	B13	B14	B15	B22	D1
20	83	81	70,5	6,5	70	26,5	30	26,5	30	12,5	58	6,5	68	31,5	18	29,5	M6
25	95	93	67	15,5	64	30	35	27,5	40	13,5	68	12,5	68	32,5	28	33,5	M6
32	110	108	77	20	70	33,5	43	35	40	16	78	15	78	41	26	41	M8
40	120	118	86	15	90	34,5	51	35	50	16	88	15	88	41	36	41	M8

1) Tolerancia entre taladros para centrar

∅ [mm]	D2 ∅	D3 ∅ H7	D4	D5 ∅ H7	D6 ∅	D7 ∅		D8 ∅ H7	D11 ∅	EE	H1	H2	H3	H4	H5	H6	H7
						GF	KF										
20	9	9	M5	9	M5	14	12	7	6	M5	36	34	29,5	4,5	27	18	7
25	9	9	M6	9	M6	16	14	7	8	G ¹ / ₈	44	42	34,8	4,5	35	22	12
32	11	12	M6	9	M6	20	16	9	8	G ¹ / ₈	49	47	39	6	37	24,5	8,5
40	11	12	M8	9	M6	20	16	9	8	G ¹ / ₈	54	52	41,5	6	42	27	10

∅ [mm]	H8	H9	L3	L4	L5	L8	L10	L12	L21	T1	T2	T3	T4	T5	T6	T7	≈C1
20	20	16,5	12	14	5,5	26	40	6	6,5	12	5,7	2,1	10	2,1	1,6	11	14
25	20	19	12	14	8,5	26	40	6	10	15	5,7	2,1	12	2,1	1,6	15	17
32	30	21	14	16	8,5	29	45	7	10	20	6,8	2,6	11	2,1	2,1	15	17
40	30	26	14	16	8,5	29	45	7	10	20	6,8	2,6	16	2,1	2,1	15	17

Carrera [mm]	Diámetro del émbolo [mm]																			
	20					25					32					40				
	L1	L2	L7	L9 ±0,02 ¹⁾	L11	L1	L2	L7	L9 ±0,02 ¹⁾	L11	L1	L2	L7	L9 ±0,02 ¹⁾	L11	L1	L2	L7	L9 ±0,02 ¹⁾	L11
20	105	82	9	20	-	111	90	7	20	-	118	95	7	20	-	-	-	-	-	-
25	110	87	9	20	-	116	95	7	20	-	123	100	7	20	-	123	101	6	20	-
30	115	92	9	20	-	121	100	7	20	-	133	105	12	20	-	-	-	-	-	-
40	135	102	19	20	-	141	110	17	20	-	143	115	12	20	-	-	-	-	-	-
50	145	112	19	40	-	151	120	17	40	-	153	125	12	40	-	153	126	11	40	-
80	185	142	29	40	-	196	150	32	40	-	208	155	37	40	-	208	156	36	40	-
100	205	162	29	40	80	216	170	32	40	80	228	175	37	40	80	228	176	36	40	80
125	257	187	56	40	80	271	195	62	40	80	283	200	67	40	80	283	201	66	40	80
160	292	222	56	40	120	306	230	62	40	120	318	235	67	40	120	318	236	66	40	120
200	332	262	56	40	160	346	270	62	40	160	358	275	67	40	160	358	276	66	40	160
250	472	312	146	40	200	476	320	142	40	200	483	325	142	40	200	483	326	141	40	200
320	542	382	146	40	240	546	390	142	40	240	553	395	142	40	240	553	396	141	40	240
400	622	462	146	40	320	626	470	142	40	320	633	475	142	40	320	633	476	141	40	320

1) Tolerancia entre taladros para centrar

! - Importante: Este producto cumple con los estándares ISO 1179-1 e ISO 228-1



! - Importante

Si las barras de guía sobresalen en la parte posterior del cuerpo (→ medida L7), debe compensarse el espacio de montaje correspon-

dientemente en la parte frontal, para que las barras puedan moverse libremente.

En el caso de carreras variable, las dimensiones L1, L2, L7, L9 y L11 corresponden a la carrera estándar siguiente.

Cilindros guiados DFM-B

Hoja de datos

FESTO

Dimensiones

Datos CAD disponibles en → www.festo.com

YSRW: Amortiguación autorregulable

Diámetro 20 ... 40 mm

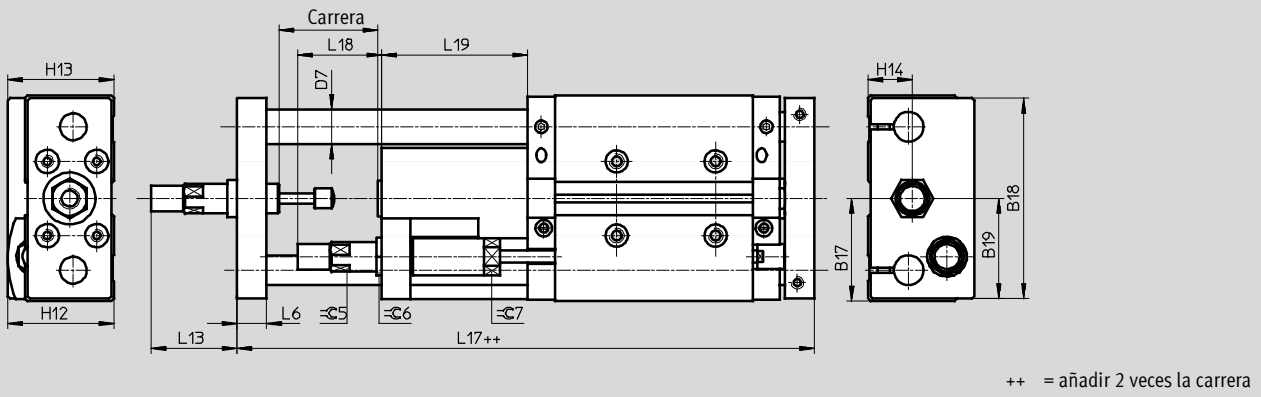

AJ/EJ: Ajuste fino de la carrera en avance y en retroceso

Diámetro 20 ... 40 mm

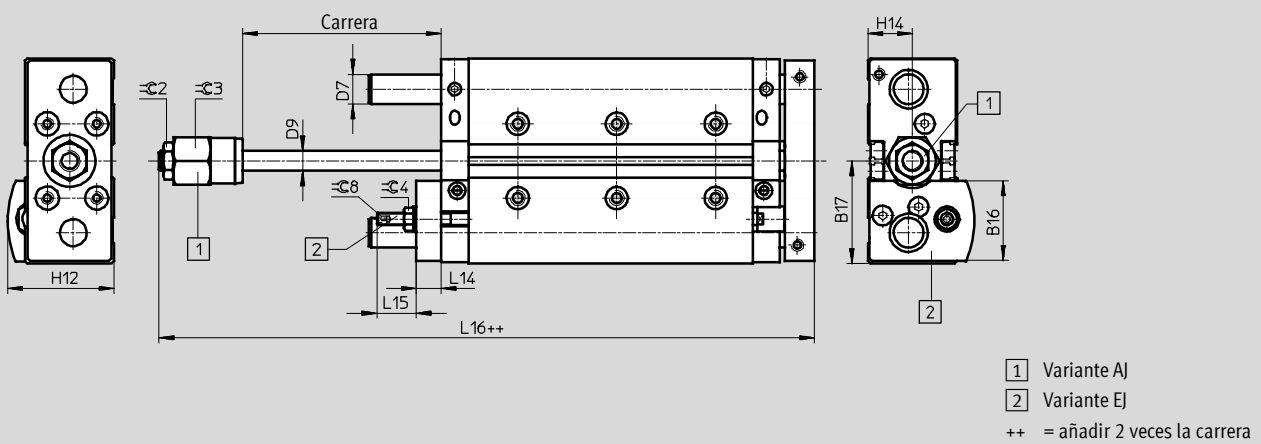

Cilindros guiados DFM-B

Hoja de datos

∅ [mm]	B16	B17	B18	B19	D7		D9 ∅	H12	H13	H14	L6	L13	L14
					GF	KF							
20	32,5	41,5	81	40,5	14	12	8	43	43	18	12	36,5	10
25	38,6	47,5	90	45	16	14	10	49,5	50,5	22	14	43	12
32	43,4	55	105	52,5	20	16	12	56,5	56	24,5	16	52	12
40	46,2	60	116	58	20	16	12	62,5	63,5	27	16	72	12

∅ [mm]	L15	L16	L17	L18	L19	≈C2	≈C3	≈C4	≈C5	≈C6	≈C7	≈C8
25	23,5	119,5	176,5	37,5	71	17	24	13	13	17	16	4
32	18,5	129,5	190,5	48,5	76	17	30	13	15	17	19	4
40	18,5	132	209,5	55,5	95	17	30	13	20	22	27	4

Cilindros guiados DFM-B

Hoja de datos

FESTO

Dimensiones

Datos CAD disponibles en → www.festo.com

Diámetro del émbolo 50 ... 63 mm

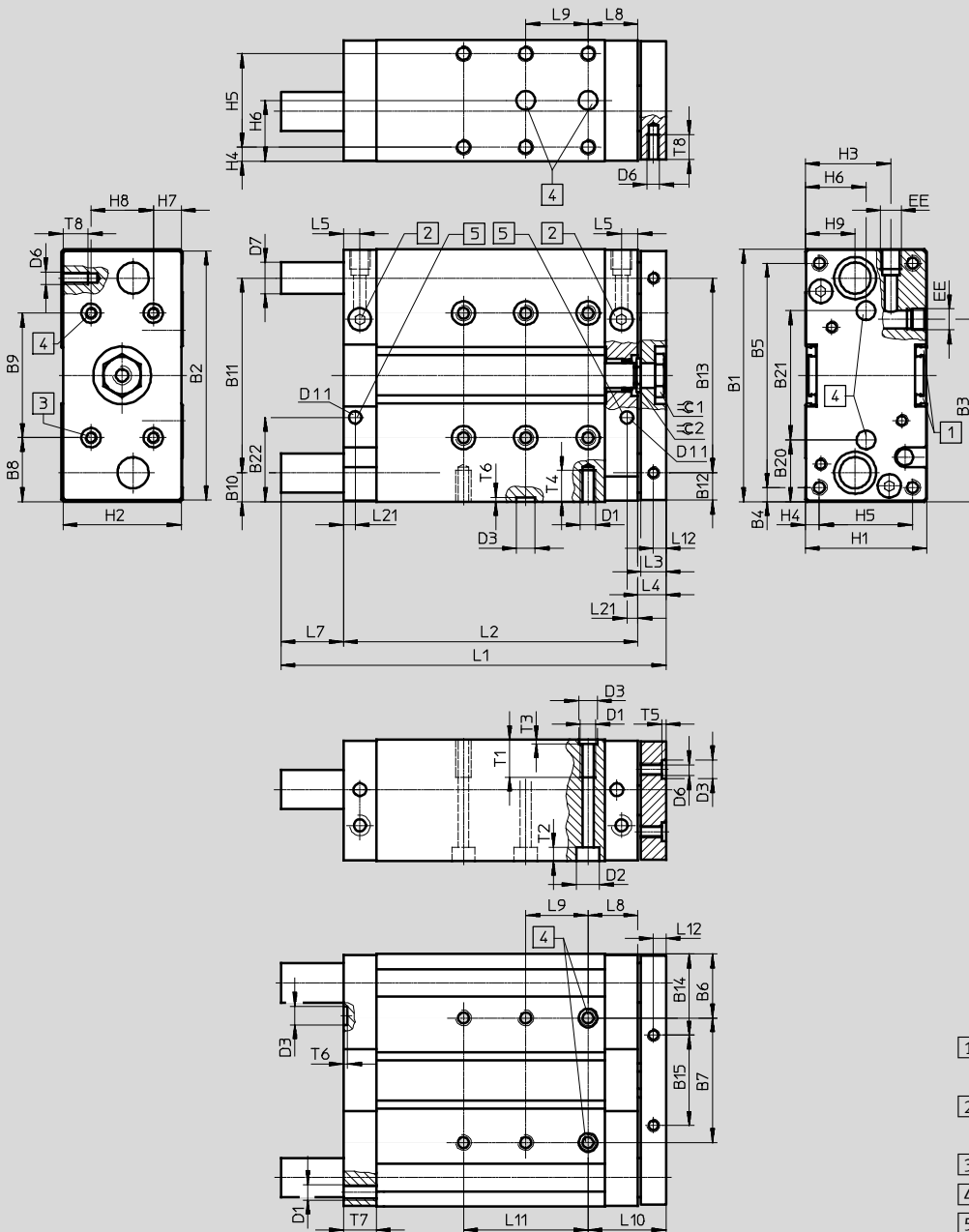

- 1 Ranura para detectores de posición
- 2 Conexión de aire arriba o lateralmente
- 3 Rosca de fijación
- 4 Taladros para centrar
- 5 Amortiguación PPV

Cilindros guiados DFM-B

Hoja de datos

∅ [mm]	B1	B2	B3	B4	B5	B6	B7 ±0,02 ¹⁾	B8	B9 ±0,02 ¹⁾	B10	B11	B12	B13	B14	B15	B20	B21 ±0,02 ¹⁾
50	148	146	104,5	19	110	42	64	44	60	19	110	18	110	52	42	40	68
63	162	160	117	9	144	41	80	41	80	18,5	125	17,5	125	51	58	39,5	83

∅ [mm]	B22	D1	D2 ∅ H7	D3 ∅ H7	D6 ∅	D7 ∅		D11 ∅	EE	H1	H2	H3	H4	H5	H6	H7	H8
						GF	KF										
50	52,5	M8	11	12	M8	25	20	8	G ¹ / ₄	64	62	48,5	7	50	32	12	40
63	54	M10	15	12	M8	25	20	8	G ¹ / ₄	78	76	55	9	60	39	19	40

∅ [mm]	H9	L3	L4	L5	L8	L10	L12	L21	T1	T2	T3	T4	T5	T6	T7	T8	≈C1	≈C2
50	29	16	18	10,5	32	50	8	13,5	20	6,8	2,6	16	2,6	2,6	21	16	24	19
63	32	16	18	10,5	32	50	8	13,5	24	9	2,6	20	2,6	2,6	21	16	24	19

Carrera [mm]	Diámetro del émbolo [mm]									
	50					63				
	L1	L2	L7	L9 ±0,02 ¹⁾	L11	L1	L2	L7	L9 ±0,02 ¹⁾	L11
25	137	113	6	20	-	137	114	5	20	-
50	177	138	21	177		139	20			
80	227	168	41	40	80	227	169	40	40	80
100	247	188				247	189			
125	293	213	62	40	120	293	214	61	40	120
160	328	248				120	328			
200	368	288	139	40	160	368	289	138	40	160
250	495	338				200	495			
320	565	408	139	40	240	565	409	138	40	240
400	645	488				240	645			

1) Tolerancia entre taladros para centrar

⚠ Importante: Este producto cumple con los estándares ISO 1179-1 e ISO 228-1

⚠ Importante

Considerando que las barras de guía sobresalen en la parte posterior del cuerpo (→ medida L7), debe compensarse el espacio de montaje correspondientemente en la parte frontal, para que las barras puedan moverse libremente.

En el caso de carreras variable, las dimensiones L1, L2, L7, L9 y L11 corresponden a la carrera estándar siguiente.

Cilindros guiados DFM-B

Hoja de datos

FESTO

Dimensiones

Datos CAD disponibles en → www.festo.com

YSRW: Amortiguación autorregulable

Diámetro 50 ... 63 mm

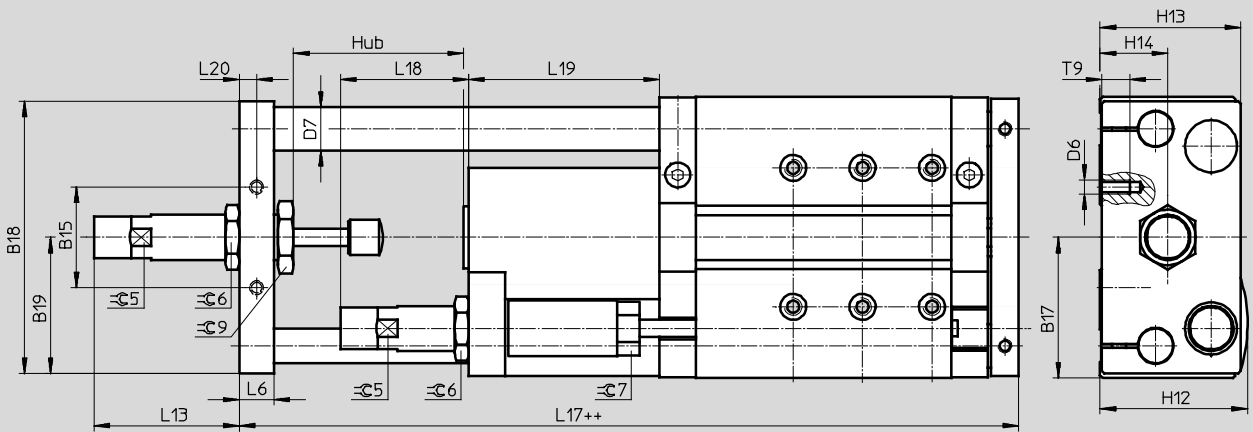

++ = añadir 2 veces la carrera

AJ/EJ: Ajuste fino de la carrera en avance y en retroceso

Diámetro 50 ... 63 mm

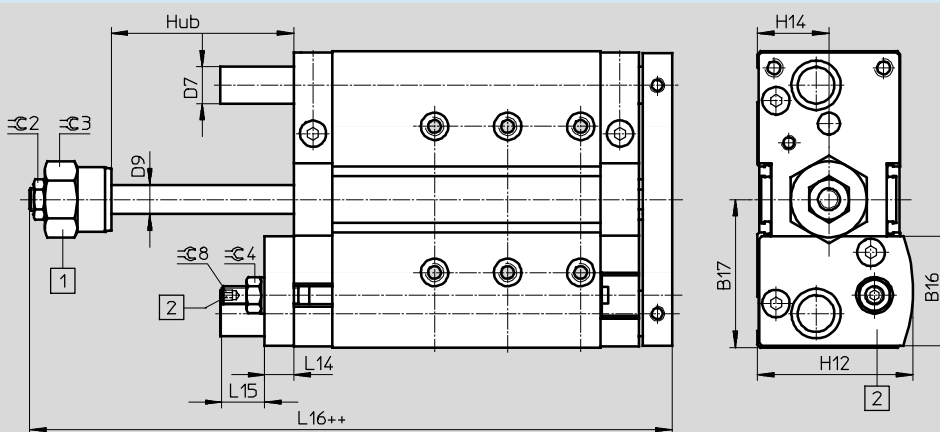

1 Variante AJ

2 Variante EJ

++ = añadir 2 veces la carrera

Cilindros guiados DFM-B

Hoja de datos

FESTO

∅ [mm]	B15	B16	B17	B18	B19	D6	D7 ∅		D9 ∅	H12	H13	H14	L6	L13	L14
							GF	KF							
50	42	57,6	74	157	72	M8	25	20	16	74	71	32	16	67,6	16
63	58	60	81	144	78,5	M8	25	20	16	81	81	39	20	83,3	16

∅ [mm]	L15	L16	L17	L18	L19	L20	T9	≈C2	≈C3	≈C4	≈C5	≈C6	≈C7	≈C8	≈C9
50	24,5	152,1	226,4	58,5	93	8	16	19	36	17	20	27	22	5	30
63	23,5	151,8	249,2	74	110	10	16	19	36	17	24	32	27	5	36

Cilindros guiados DFM-B con guía deslizante GF

Referencias: conjunto de productos

M Indicaciones mínimas →

Nº de artículo	Función	Tamaño	Carrera	Generación	Amortiguación	Detección de posiciones	Guía
529 119	DFM	12	10 ... 400	B	P PPV	A	GF
529 120							
532 316							
532 317							
532 318							
532 319							
534 769							
534 770							
Ejemplo de pedido							
532 319	DFM	- 40	- 400	- B	- P	- A	- GF

Tablas para realizar los pedidos

Tamaño	12	16	20	25	32	40	50	63	Condiciones	Código	Entrada código	
M Nº de artículo	529 119	529 120	532 316	532 317	532 318	532 319	534 769	534 770				
Función	Eje guía, modular									DFM	DFM	
Tamaño	12	16	20	25	32	40	50	63		-...		
Carrera [mm]	10	10	-	-	-	-	-	-		-...		
	20	20	20	20	20	-	-	-		-...		
	25	25	25	25	25	25	25	25		-...		
	30	30	30	30	30	-	-	-		-...		
	40	40	40	40	40	-	-	-		-...		
	50	50	50	50	50	50	50	50		-...		
	80	80	80	80	80	80	80	80		-...		
	100	100	100	100	100	100	100	100		-...		
	125	125	125	125	125	125	125	125		-...		
	160	160	160	160	160	160	160	160		-...		
	200	200	200	200	200	200	200	200		-...		
	-	-	250	250	250	250	250	250		-...		
	-	-	320	320	320	320	320	320		-...		
-	-	400	400	400	400	400	400		-...			
Carrera variable [mm]	10 ... 200		20 ... 400			25 ... 400			[1]	-...		
Generación	Serie B									-B	-B	
Amortiguación	Anillos y discos elásticos en ambos lados									-P		
	-	Amortiguación neumática regulable en ambos lados									[2]	-PPV
Detección de posiciones	Para detectores de proximidad									-A	-A	
Guía	Guía de deslizamiento									-GF	-GF	

[1] ... No en combinación con ajuste fino en la posiciones finales AJ

[2] PPV No en combinación con ajuste fino en la posiciones finales AJ, EJ

Continúa: código de pedido

DFM - - - **B** - - **A** - - **GF**

Cilindros guiados DFM-B con guía deslizante GF

Referencias: conjunto de productos

[0] Opcional						
Termorresistente	Ajuste fino en la posición final avanzada	Ajuste fino en la posición final retraída	Accesorios	Tapa para ranura de detectores	Detector de posiciones con cable	Detector de posiciones sin contacto, con cable
S6	AJ	EJ	ZUB	...S	...G	...I
- S6	- AJ	- EJ	ZUB	- 10S	10G	10I

Tablas para realizar los pedidos												
Tamaño	12	16	20	25	32	40	50	63	Condiciones	Código	Entrada código	
[0] Termorresistente	Juntas termorresistentes hasta máx. 120 °C								[3]	S6		
Ajuste fino en la posición final avanzada	Ajuste fino en la posición avanzada									-AJ		
Ajuste fino en la posición final retraída	-	-	Ajuste fino en retroceso							-EJ		
Accesorios	Incluidos sueltos en el suministro									ZUB-	ZUB-	
Tapa para ranura de detectores	1 ... 10									...S		
Detectores de posición	Con cable de 2,5 m	1 ... 10									...G	
	Sin contacto, con cable de 2,5 m	1 ... 10									...I	

[3] S6 No en combinación con ajuste fino en la posiciones finales AJ, EJ

Continúa: código de pedido

- [] - [] - [] ZUB - [] [] []

Cilindros guiados DFM-B con guía de rodamientos KF

Referencias: conjunto de productos

M Indicaciones mínimas →

Nº de artículo	Función	Tamaño	Carrera	Generación	Amortiguación	Detección de posiciones	Guía
529 119	DFM	12	10 ... 400	B	P PPV YSRW	A	KF
529 120							
532 316							
532 317							
532 318							
532 319							
534 769							
534 770							
Ejemplo de pedido							
532 319	DFM	- 40	- 400	- B	- P	- A	- KF

Tablas para realizar los pedidos

Tamaño	12	16	20	25	32	40	50	63	Condiciones	Código	Entrada código	
M Nº de artículo	529 119	529 120	532 316	532 317	532 318	532 319	534 769	534 770				
Función	Eje guía, modular									DFM	DFM	
Tamaño	12	16	20	25	32	40	50	63		-...		
Carrera [mm]	10	10	-	-	-	-	-	-		-...		
	20	20	20	20	20	-	-	-		-...		
	25	25	25	25	25	25	25	25		-...		
	30	30	30	30	30	-	-	-		-...		
	40	40	40	40	40	-	-	-		-...		
	50	50	50	50	50	50	50	50		-...		
	80	80	80	80	80	80	80	80		-...		
	100	100	100	100	100	100	100	100		-...		
	125	125	125	125	125	125	125	125		-...		
	160	160	160	160	160	160	160	160		-...		
	200	200	200	200	200	200	200	200		-...		
	-	-	250	250	250	250	250	250		-...		
	-	-	320	320	320	320	320	320		-...		
-	-	400	400	400	400	400	400		-...			
Carrera variable [mm]	10 ... 200		20 ... 400			25 ... 400			1	-...		
Generación	Serie B									-B	-B	
Amortiguación	Anillos y discos elásticos en ambos lados									-P		
	-	Amortiguación neumática regulable en ambos lados								2	-PPV	
	-	Amortiguador con curva característica progresiva								3	-YSRW	
Detección de posiciones	Para detectores de proximidad									-A	-A	
Guía	Guías con rodamiento de bolas									-KF	-KF	

1 ... No en combinación con ajuste fino en las posiciones finales AI, amortiguación YSRW 3 YSRW No con ajuste fino en las posiciones finales AI, EI, ya que está integrado
 2 PPV No en combinación con ajuste fino en las posiciones finales AI, EI

Continúa: código de pedido

Cilindros guiados DFM-B con guía de rodamientos KF

Referencias: conjunto de productos

Opcional					
Ajuste fino en la posición final avanzada	Ajuste fino en la posición final retraída	Accesorios	Tapa para ranura de detectores	Detector de posiciones con cable	Detector de posiciones sin contacto, con cable
AJ	EJ	ZUB	...S	...G	...I
- AJ	- EJ	ZUB	- 10S	10G	10I

Tablas para realizar los pedidos											
Tamaño	12	16	20	25	32	40	50	63	Condiciones	Código	Entrada código
O Ajuste fino en la posición final avanzada	Ajuste fino en la posición avanzada									-AJ	
Ajuste fino en la posición final retraída	-	-	Ajuste fino en retroceso							-EJ	
Accesorios	Incluidos sueltos en el suministro:									ZUB-	ZUB-
Tapa para ranura de detectores	1 ... 10									...S	
Detectores de posición	Con cable de 2,5 m		1 ... 10							...G	
	Sin contacto, con cable de 2,5 m		1 ... 10							...I	

Continúa: código de pedido

- - ZUB -

Cilindros guiados DFM/DFM-B

Accesorios

FESTO

Casquillo para centrar ZBH

Material:
Acero de aleación fina

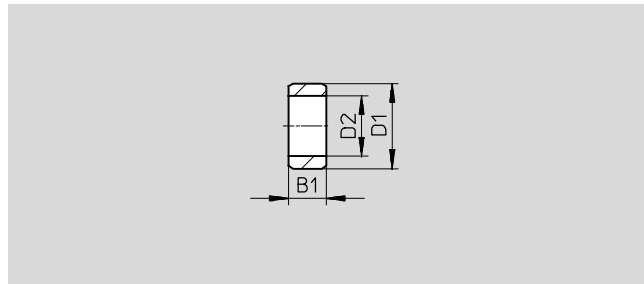

Dimensiones y referencias (para pedidos posteriores)							
B1	D1	D2	CRC ¹⁾	Peso	Nº de art.	Tipo	PE ²⁾
-0,2	∅ h7	∅		[g]			
2,4	5	3,2	2	1	189652	ZBH-5	10
3	7	5,3	2	1	186717	ZBH-7	10
4	9	6,4	2	1	150927	ZBH-9	10
5	12	10,3	2	1	189653	ZBH-12	10
6	15	12,4	2	1	191409	ZBH-15	10

1) Clase de resistencia a la corrosión 2 según norma de Festo 940 070

Válida para piezas expuestas a gran peligro de corrosión. Piezas exteriores en contacto directo con sustancias usuales en entornos industriales, tales como disolventes, detergentes o lubricantes, con superficies principalmente decorativas.

2) Cantidad por unidad de embalaje.

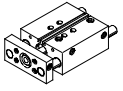
Casquillos para centrar incluidos en la dotación del suministro			
DFM	Diámetro del émbolo [mm]	Casquillos para centrar	
		para el cuerpo	Para la placa orientable
	12	2x ZBH-5, 2x ZBH-9	2x ZBH-5
	16	2x ZBH-5, 2x ZBH-9	2x ZBH-5
	20	2x ZBH-7, 2x ZBH-9	2x ZBH-9
	25	2x ZBH-7, 2x ZBH-9	2x ZBH-9
	32	2x ZBH-9, 2x ZBH-12	2x ZBH-9
	40	2x ZBH-9, 2x ZBH-12	2x ZBH-9
	50	2x ZBH-12	2x ZBH-12
	63	2x ZBH-12	2x ZBH-12
	80	2x ZBH-12	2x ZBH-12
	100	2x ZBH-15	2x ZBH-15

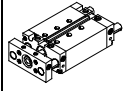
Casquillos para centrar incluidos en la dotación del suministro			
DFM-B	Diámetro del émbolo [mm]	Casquillos para centrar	
		para el cuerpo	Para la placa orientable
	12	2x ZBH-5, 2x ZBH-9	2x ZBH-5
	16	2x ZBH-5, 2x ZBH-9	2x ZBH-5
	20	2x ZBH-7, 2x ZBH-9	2x ZBH-9
	25	2x ZBH-7, 2x ZBH-9	2x ZBH-9
	32	2x ZBH-9, 2x ZBH-12	2x ZBH-9
	40	2x ZBH-9, 2x ZBH-12	2x ZBH-9
	50	2x ZBH-12	2x ZBH-12
	63	2x ZBH-12	2x ZBH-12
	-	-	-
	-	-	-

Cilindros guiados DFM/DFM-B

Accesorios

Detectores de posición para diámetros de émbolo de 12

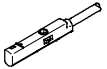
Referencias: detectores de posición para ranura en C, magnetorresistivos							Hojas de datos → Internet: smt
	Tipo de fijación	Salida digital	Conexión eléctrica, sentido de salida de la conexión	Longitud del cable [m]	Nº art.	Tipo	
Contacto normalmente abierto							
	Montaje en la ranura desde la parte superior	PNP	Cable, trifilar, frontal	2,5	551373	SMT-10M-PS-24V-E-2,5-L-OE	
			Conector M8x1, 3 contactos, frontal	0,3	551375	SMT-10M-PS-24V-E-0,3-L-M8D	
			Conector M8x1, 3 contactos, lateral	0,3	551376	SMT-10M-PS-24V-E-0,3-Q-M8D	

Referencias: detectores de posición para ranura en C, Reed magnéticos

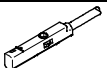
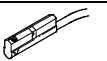
Referencias: detectores de posición para ranura en C, Reed magnéticos							Hojas de datos → Internet: sme
	Tipo de fijación	Salida digital	Conexión eléctrica, sentido de salida de la conexión	Longitud del cable [m]	Nº art.	Tipo	
Contacto normalmente abierto							
	Montaje en la ranura desde la parte superior	Con contacto	Conector M8x1, 3 contactos, frontal	0,3	551367	SME-10M-DS-24V-E-0,3-L-M8D	
			Cable, trifilar, frontal	2,5	551365	SME-10M-DS-24V-E-2,5-L-OE	
			Cable, bifilar, frontal	2,5	551369	SME-10M-ZS-24V-E-2,5-L-OE	
	Montaje en la ranura desde la parte superior	Con contacto	Conector M8x1, 3 contactos, frontal	0,3	173212	SME-10-SL-LED-24	
			Cable, trifilar, frontal	2,5	173210	SME-10-KL-LED-24	

Detectores de posición para diámetros de émbolo de 16 ... 63

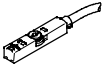
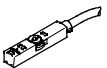
Referencias: detectores de posición para ranura en T, magnetorresistivos							Hojas de datos → Internet: smt
	Tipo de fijación	Salida digital	Conexión eléctrica	Longitud del cable [m]	Nº art.	Tipo	
Contacto normalmente abierto							
	Montaje en la ranura desde la parte superior, a ras con el perfil del cilindro, corto	PNP	Cable, trifilar	2,5	574335	SMT-8M-A-PS-24V-E-2,5-OE	
			Conector M8x1, 3 contactos	0,3	574334	SMT-8M-A-PS-24V-E-0,3-M8D	
			Conector M12x1, 3 contactos	0,3	574337	SMT-8M-A-PS-24V-E-0,3-M12	
		NPN	Cable, trifilar	2,5	574338	SMT-8M-A-NS-24V-E-2,5-OE	
			Conector M8x1, 3 contactos	0,3	574339	SMT-8M-A-NS-24V-E-0,3-M8D	
Contacto normalmente cerrado							
	Montaje en la ranura desde la parte superior, a ras con el perfil del cilindro, corto	PNP	Cable, trifilar	7,5	574340	SMT-8M-A-PO-24V-E-7,5-OE	



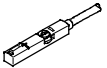
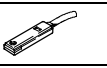
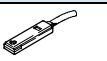

Referencias: detectores de posición para ranura en T, Reed magnéticos

Referencias: detectores de posición para ranura en T, Reed magnéticos							Hojas de datos → Internet: sme
	Tipo de fijación	Salida digital	Conexión eléctrica	Longitud del cable [m]	Nº art.	Tipo	
Contacto normalmente abierto							
	Montaje en la ranura desde la parte superior, a ras con el perfil del cilindro	Con contacto	Cable, trifilar	2,5	543862	SME-8M-DS-24V-K-2,5-OE	
			Cable, bifilar	2,5	543872	SME-8M-ZS-24V-K-2,5-OE	
			Conector M8x1, 3 contactos	0,3	543861	SME-8M-DS-24V-K-0,3-M8D	
			Conector M8x1, 3 contactos	0,3	543863	SME-8M-DS-24V-K-5,0-OE	
	Introducción a lo largo de la ranura, a ras con el perfil del cilindro	Con contacto	Cable, trifilar	2,5	150855	SME-8-K-LED-24	
			Conector M8x1, 3 contactos	0,3	150857	SME-8-S-LED-24	
Contacto normalmente cerrado							
	Introducción a lo largo de la ranura, a ras con el perfil del cilindro	Con contacto	Cable, trifilar	7,5	160251	SME-8-O-K-LED-24	

Cilindros guiados DFM/DFM-B

Accesorios

FESTO

Referencias: cables				Hojas de datos → Internet: nebu	
	Conexión eléctrica en el lado izquierdo	Conexión eléctrica en el lado derecho	Longitud del cable [m]	Nº art.	Tipo
	Conector recto tipo zócalo M8x1, 3 contactos	Cable de 3 hilos, extremo libre	2,5	541333	NEBU-M8G3-K-2.5-LE3
			5	541334	NEBU-M8G3-K-5-LE3
	Conector recto tipo zócalo M12x1, 5 contactos	Cable de 3 hilos, extremo libre	2,5	541363	NEBU-M12G5-K-2.5-LE3
			5	541364	NEBU-M12G5-K-5-LE3
	Conector acodado tipo zócalo M8x1, 3 contactos	Cable de 3 hilos, extremo libre	2,5	541338	NEBU-M8W3-K-2.5-LE3
			5	541341	NEBU-M8W3-K-5-LE3
	Conector acodado tipo zócalo M12x1, 5 contactos	Cable de 3 hilos, extremo libre	2,5	541367	NEBU-M12W5-K-2.5-LE3
			5	541370	NEBU-M12W5-K-5-LE3

Referencias: tapa de ranura en T			
	Montaje	Longitud [m]	Nº de art. Tipo
	Enchufable	2x 0,5	151680 ABP-5-S

Referencias: válvulas reguladoras de caudal			Hojas de datos → Internet: grla		
	Conexión		Material	Nº de art.	Tipo
	Rosca	Para tubo de diámetro exterior			
	M5	3	Ejecución en metal	193137	GRLA-M5-QS-3-D
		4		193138	GRLA-M5-QS-4-D
		6		193139	GRLA-M5-QS-6-D
	G ¹ / ₈	3		193142	GRLA- ¹ / ₈ -QS-3-D
		4		193143	GRLA- ¹ / ₈ -QS-4-D
		6		193144	GRLA- ¹ / ₈ -QS-6-D
		8		193145	GRLA- ¹ / ₈ -QS-8-D
	G ¹ / ₄	6		193146	GRLA- ¹ / ₄ -QS-6-D
		8		193147	GRLA- ¹ / ₄ -QS-8-D
		10		193148	GRLA- ¹ / ₄ -QS-10-D
	G ³ / ₈	6		193149	GRLA- ³ / ₈ -QS-6-D
		8		193150	GRLA- ³ / ₈ -QS-8-D
		10		193151	GRLA- ³ / ₈ -QS-10-D