

# Membran-Lufttrockner MS-LDM1, Baureihe MS

**FESTO**



# Membran-Lufttrockner MS-LDM1, Baureihe MS

Lieferübersicht Wartungsgeräte Baureihe MS

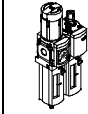
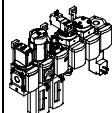
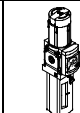
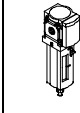
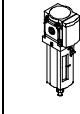
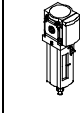
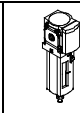

Typ	Bau- größe	Pneumatischer Anschluss im Gehäuse	Anschlussplatte	Druckregelbereich [bar]						Filterfeinheit [µm]			
				0,05 ...	0,05 ...	0,1 ...	0,3 ...	0,1 ...	0,5 ...	0,01	1	5	40
Code			AG...	D2	D4	D5	D6	D7	D8	A	B	C	E
<b>Wartungseinheiten</b>													
<b>MSB-FRC</b> 	4	G <sup>1</sup> / <sub>8</sub> , G <sup>1</sup> / <sub>4</sub>	G <sup>1</sup> / <sub>8</sub> , G <sup>1</sup> / <sub>4</sub> , G <sup>3</sup> / <sub>8</sub>	-	-	-	■	■	-	-	-	■	■
	6	G <sup>1</sup> / <sub>4</sub> , G <sup>3</sup> / <sub>8</sub> , G <sup>1</sup> / <sub>2</sub>	G <sup>1</sup> / <sub>4</sub> , G <sup>3</sup> / <sub>8</sub> , G <sup>1</sup> / <sub>2</sub> , G <sup>3</sup> / <sub>4</sub>	-	-	-	■	■	-	-	-	■	■
	9	-											
	12	-											
<b>Wartungsgeräte-Kombinationen (weitere Varianten bestellbar über Konfigurator → Internet: msb4, msb6 oder msb9)</b>													
<b>MSB</b> 	4	G <sup>1</sup> / <sub>4</sub>	G <sup>1</sup> / <sub>8</sub> , G <sup>1</sup> / <sub>4</sub> , G <sup>3</sup> / <sub>8</sub>	-	-	-	■	■	-	-	-	■	■
	6	G <sup>1</sup> / <sub>2</sub>	G <sup>1</sup> / <sub>4</sub> , G <sup>3</sup> / <sub>8</sub> , G <sup>1</sup> / <sub>2</sub> , G <sup>3</sup> / <sub>4</sub>	-	-	-	■	■	-	-	-	■	■
	9	-											
	12	-											
<b>Einzelgeräte</b>													
<b>Filterregel- ventile</b> <b>MS-LFR</b> 	4	G <sup>1</sup> / <sub>8</sub> , G <sup>1</sup> / <sub>4</sub>	G <sup>1</sup> / <sub>8</sub> , G <sup>1</sup> / <sub>4</sub> , G <sup>3</sup> / <sub>8</sub>	-	-	■	■	■	-	-	-	■	■
	6	G <sup>1</sup> / <sub>4</sub> , G <sup>3</sup> / <sub>8</sub> , G <sup>1</sup> / <sub>2</sub>	G <sup>1</sup> / <sub>4</sub> , G <sup>3</sup> / <sub>8</sub> , G <sup>1</sup> / <sub>2</sub> , G <sup>3</sup> / <sub>4</sub>	-	-	■	■	■	■	-	-	■	■
	9	G <sup>3</sup> / <sub>4</sub> , G1	G <sup>1</sup> / <sub>2</sub> , G <sup>3</sup> / <sub>4</sub> , G1, G <sup>1</sup> / <sub>4</sub> , G <sup>1</sup> / <sub>2</sub>	-	-	■	■	■	■	-	-	■	■
	12	-	G1, G <sup>1</sup> / <sub>4</sub> , G <sup>1</sup> / <sub>2</sub> , G2	-	-	-	■	■	■	-	-	■	■
<b>Filter</b> <b>MS-LF</b> 	4	G <sup>1</sup> / <sub>8</sub> , G <sup>1</sup> / <sub>4</sub>	G <sup>1</sup> / <sub>8</sub> , G <sup>1</sup> / <sub>4</sub> , G <sup>3</sup> / <sub>8</sub>	-	-	-	-	-	-	-	-	■	■
	6	G <sup>1</sup> / <sub>4</sub> , G <sup>3</sup> / <sub>8</sub> , G <sup>1</sup> / <sub>2</sub>	G <sup>1</sup> / <sub>4</sub> , G <sup>3</sup> / <sub>8</sub> , G <sup>1</sup> / <sub>2</sub> , G <sup>3</sup> / <sub>4</sub>	-	-	-	-	-	-	-	-	■	■
	9	G <sup>3</sup> / <sub>4</sub> , G1	G <sup>1</sup> / <sub>2</sub> , G <sup>3</sup> / <sub>4</sub> , G1, G <sup>1</sup> / <sub>4</sub> , G <sup>1</sup> / <sub>2</sub>	-	-	-	-	-	-	-	-	■	■
	12	-	G1, G <sup>1</sup> / <sub>4</sub> , G <sup>1</sup> / <sub>2</sub> , G2	-	-	-	-	-	-	-	-	■	■
<b>Fein- und Feinstfilter</b> <b>MS-LFM</b> 	4	G <sup>1</sup> / <sub>8</sub> , G <sup>1</sup> / <sub>4</sub>	G <sup>1</sup> / <sub>8</sub> , G <sup>1</sup> / <sub>4</sub> , G <sup>3</sup> / <sub>8</sub>	-	-	-	-	-	-	■	■	-	-
	6	G <sup>1</sup> / <sub>4</sub> , G <sup>3</sup> / <sub>8</sub> , G <sup>1</sup> / <sub>2</sub>	G <sup>1</sup> / <sub>4</sub> , G <sup>3</sup> / <sub>8</sub> , G <sup>1</sup> / <sub>2</sub> , G <sup>3</sup> / <sub>4</sub>	-	-	-	-	-	-	■	■	-	-
	9	G <sup>3</sup> / <sub>4</sub> , G1	G <sup>1</sup> / <sub>2</sub> , G <sup>3</sup> / <sub>4</sub> , G1, G <sup>1</sup> / <sub>4</sub> , G <sup>1</sup> / <sub>2</sub>	-	-	-	-	-	-	■	■	-	-
	12	-	G1, G <sup>1</sup> / <sub>4</sub> , G <sup>1</sup> / <sub>2</sub> , G2	-	-	-	-	-	-	■	■	-	-
<b>Aktivkohle- filter</b> <b>MS-LFX</b> 	4	G <sup>1</sup> / <sub>8</sub> , G <sup>1</sup> / <sub>4</sub>	G <sup>1</sup> / <sub>8</sub> , G <sup>1</sup> / <sub>4</sub> , G <sup>3</sup> / <sub>8</sub>	-	-	-	-	-	-	-	-	-	-
	6	G <sup>1</sup> / <sub>4</sub> , G <sup>3</sup> / <sub>8</sub> , G <sup>1</sup> / <sub>2</sub>	G <sup>1</sup> / <sub>4</sub> , G <sup>3</sup> / <sub>8</sub> , G <sup>1</sup> / <sub>2</sub> , G <sup>3</sup> / <sub>4</sub>	-	-	-	-	-	-	-	-	-	-
	9	G <sup>3</sup> / <sub>4</sub> , G1	G <sup>1</sup> / <sub>2</sub> , G <sup>3</sup> / <sub>4</sub> , G1, G <sup>1</sup> / <sub>4</sub> , G <sup>1</sup> / <sub>2</sub>	-	-	-	-	-	-	-	-	-	-
	12	-	G1, G <sup>1</sup> / <sub>4</sub> , G <sup>1</sup> / <sub>2</sub> , G2	-	-	-	-	-	-	-	-	-	-
<b>Wasser- abscheider</b> <b>MS-LWS</b> 	4	-											
	6	G <sup>1</sup> / <sub>4</sub> , G <sup>3</sup> / <sub>8</sub> , G <sup>1</sup> / <sub>2</sub>	G <sup>1</sup> / <sub>4</sub> , G <sup>3</sup> / <sub>8</sub> , G <sup>1</sup> / <sub>2</sub> , G <sup>3</sup> / <sub>4</sub>	-	-	-	-	-	-	-	-	-	-
	9	G <sup>3</sup> / <sub>4</sub> , G1	G <sup>1</sup> / <sub>2</sub> , G <sup>3</sup> / <sub>4</sub> , G1, G <sup>1</sup> / <sub>4</sub> , G <sup>1</sup> / <sub>2</sub>	-	-	-	-	-	-	-	-	-	-
	12	-	G1, G <sup>1</sup> / <sub>4</sub> , G <sup>1</sup> / <sub>2</sub> , G2	-	-	-	-	-	-	-	-	-	-

# Membran-Lufttrockner MS-LDM1, Baureihe MS



Lieferübersicht Wartungsgeräte Baureihe MS

Typ	Bau- größe	Schalen- schutz		Kondensatablass				Druckanzeige					Abschließ- barkeit		Optionen		→ Seite/ Internet
		Kunststoffschutzkorb	Metallschale	manuell drehend	halbautomatisch	vollautomatisch	extern, vollautoma- tisch, elektrisch	Verschlussblende (ohne Manometer)	integriertes MS-Manometer	Adapter EN-Manometer G1/8	Adapter EN-Manometer G1/4	Drucksensor	Drehknopf mit Arretie- rung, mit Zubehör abschließbar	Drehknopf mit inte- griertem Schloss	Schalldämpfer	Durchflussrichtung von rechts nach links	
Code		R	U	M	H	V	E...	VS	AG	A8	A4	AD...	AS	E11	S	Z	
<b>Wartungseinheiten</b>																	
<b>MSB-FRC</b>	4	■	-	■	-	■	-	-	■	-	-	-	■	-	-	■	msb4
	6	■	■	■	-	■	-	-	■	-	-	-	■	-	-	■	msb6
	9	-	-	-	-	-	-	-	-	-	-	-	-	-	-	-	-
	12	-	-	-	-	-	-	-	-	-	-	-	-	-	-	-	-
<b>Wartungsgeräte-Kombinationen</b>																	
<b>MSB</b>	4	■	■	■	-	■	-	-	■	-	-	-	■	-	-	■	msb4
	6	■	■	■	-	■	-	-	■	-	-	-	■	-	-	■	msb6
	9	-	-	-	-	-	-	-	-	-	-	-	-	-	-	-	-
	12	-	-	-	-	-	-	-	-	-	-	-	-	-	-	-	-
<b>Einzelgeräte</b>																	
Filterregel- ventile	4	■	■	■	■	■	-	■	■	■	■	■	■	■	-	■	ms4-lfr
	6	■	■	■	■	■	■	■	■	-	■	■	■	■	-	■	ms6-lfr
<b>MS-LFR</b>	9	-	■	■	■	■	■	■	■	-	■	■	■	■	-	■	ms9-lfr
	12	-	■	■	-	■	■	■	■	-	■	-	■	■	-	■	ms12-lfr
Filter <b>MS-LF</b>	4	■	■	■	■	■	-	-	-	-	-	-	-	-	-	■	ms4-lf
	6	■	■	■	■	■	■	-	-	-	-	-	-	-	-	■	ms6-lf
	9	-	■	■	■	■	■	-	-	-	-	-	-	-	-	■	ms9-lf
	12	-	■	■	-	■	■	-	-	-	-	-	-	-	-	■	ms12-lf
Fein- und Feinstfilter <b>MS-LFM</b>	4	■	■	■	■	■	-	-	-	-	-	-	-	-	-	■	ms4-lfm
	6	■	■	■	■	■	■	-	-	-	-	-	-	-	-	■	ms6-lfm
	9	-	■	■	■	■	■	-	-	-	-	-	-	-	-	■	ms9-lfm
	12	-	■	■	-	■	■	-	-	-	-	-	-	-	-	■	ms12-lfm
Aktivkohle- filter <b>MS-LFX</b>	4	■	■	-	-	-	-	-	-	-	-	-	-	-	-	■	ms4-lfx
	6	■	■	-	-	-	-	-	-	-	-	-	-	-	-	■	ms6-lfx
	9	-	■	-	-	-	-	-	-	-	-	-	-	-	-	■	ms9-lfx
	12	-	■	-	-	-	-	-	-	-	-	-	-	-	-	■	ms12-lfx
Wasser- abscheider <b>MS-LWS</b>	4	-	-	-	-	-	-	-	-	-	-	-	-	-	-	-	-
	6	-	■	-	-	■	■	-	-	-	-	-	-	-	-	■	ms6-lws
	9	-	■	-	-	■	■	-	-	-	-	-	-	-	-	■	ms9-lws
	12	-	■	-	-	■	■	-	-	-	-	-	-	-	-	■	ms12-lws

# Membran-Lufttrockner MS-LDM1, Baureihe MS

Lieferübersicht Wartungsgeräte Baureihe MS



Typ	Bau- größe	Pneumatischer Anschluss im Gehäuse	Anschlussplatte	Druckregelbereich [bar]							Versorgungsspannung			
				0,05 ...	0,05 ...	0,1 ...	0,3 ...	0,1 ...	0,5 ...	24 V DC, Anschlussbild nach EN 175301	24 V DC, Anschluss M12 nach IEC 61076-2-101	110 V AC, Anschlussbild nach EN 175301	230 V AC, Anschlussbild nach EN 175301	
Code			AG...	D2	D4	D5	D6	D7	D8	V24	V24P	V110	V230	
<b>Einzelgeräte</b>														
Druckregel- ventile <b>MS-LR</b>		4	G1/8, G1/4	G1/8, G1/4, G3/8	-	-	■	■	■	-	-	-	-	
		6	G1/4, G3/8, G1/2	G1/4, G3/8, G1/2, G3/4	-	-	■	■	■	■	-	-	-	
		9	G3/4, G1	G1/2, G3/4, G1, G1 1/4, G1 1/2	-	-	■	■	■	■	-	-	-	
		12	-	G1, G1 1/4, G1 1/2, G2	-	-	-	■	■	■	-	-	-	
Druckregel- ventile <b>MS-LRB</b>		4	G1/4	G1/8, G1/4, G3/8	-	-	■	■	■	-	-	-	-	
		6	G1/2	G1/4, G3/8, G1/2, G3/4	-	-	■	■	■	■	-	-	-	
		9	-	-	-	-	-	-	-	-	-	-	-	
		12	-	-	-	-	-	-	-	-	-	-	-	
Präzisions- Druckregel- ventile <b>MS-LRP</b>		4	-	-	-	-	-	-	-	-	-	-	-	
		6	G1/4, G3/8, G1/2	G1/4, G3/8, G1/2, G3/4	■	■	■	-	■	-	-	-	-	
		9	-	-	-	-	-	-	-	-	-	-	-	
		12	-	-	-	-	-	-	-	-	-	-	-	
Präzisions- Druckregel- ventile <b>MS-LRPB</b>		4	-	-	-	-	-	-	-	-	-	-	-	
		6	G1/2	G1/4, G3/8, G1/2, G3/4	■	■	■	-	■	-	-	-	-	
		9	-	-	-	-	-	-	-	-	-	-	-	
		12	-	-	-	-	-	-	-	-	-	-	-	
Elektrik-Druck- regelventile <b>MS-LRE</b>		4	-	-	-	-	-	-	-	-	-	-	-	
		6	G1/4, G3/8, G1/2	G1/4, G3/8, G1/2, G3/4	-	-	■	■	■	■	-	-	-	
		9	-	-	-	-	-	-	-	-	-	-	-	
		12	-	-	-	-	-	-	-	-	-	-	-	
Öler <b>MS-LOE</b>		4	G1/8, G1/4	G1/8, G1/4, G3/8	-	-	-	-	-	-	-	-	-	
		6	G1/4, G3/8, G1/2	G1/4, G3/8, G1/2, G3/4	-	-	-	-	-	-	-	-	-	
		9	G3/4, G1	G1/2, G3/4, G1, G1 1/4, G1 1/2	-	-	-	-	-	-	-	-	-	
		12	-	G1, G1 1/4, G1 1/2, G2	-	-	-	-	-	-	-	-	-	
Einschalt- ventile <b>MS-EM(1)</b>		4	G1/8, G1/4	G1/8, G1/4, G3/8	-	-	-	-	-	-	-	-	-	
		6	G1/4, G3/8, G1/2	G1/4, G3/8, G1/2, G3/4	-	-	-	-	-	-	-	-	-	
		9	G3/4, G1	G1/2, G3/4, G1, G1 1/4, G1 1/2	-	-	-	-	-	-	-	-	-	
		12	-	G1, G1 1/4, G1 1/2, G2	-	-	-	-	-	-	-	-	-	
Einschalt- ventile <b>MS-EE</b>		4	G1/8, G1/4	G1/8, G1/4, G3/8	-	-	-	-	-	-	■	-	■	
		6	G1/4, G3/8, G1/2	G1/4, G3/8, G1/2, G3/4	-	-	-	-	-	-	■	-	■	
		9	G3/4, G1	G1/2, G3/4, G1, G1 1/4, G1 1/2	-	-	-	-	-	-	■	■	■	
		12	-	G1, G1 1/4, G1 1/2, G2	-	-	-	-	-	-	■	■	■	
Druckaufbau- ventile <b>MS-DL</b>		4	G1/8, G1/4	G1/8, G1/4, G3/8	-	-	-	-	-	-	-	-	-	
		6	G1/4, G3/8, G1/2	G1/4, G3/8, G1/2, G3/4	-	-	-	-	-	-	-	-	-	
		9	-	-	-	-	-	-	-	-	-	-	-	
		12	-	G1, G1 1/4, G1 1/2, G2	-	-	-	-	-	-	-	-	-	
Druckaufbau- ventile <b>MS-DE</b>		4	G1/8, G1/4	G1/8, G1/4, G3/8	-	-	-	-	-	-	■	-	■	
		6	G1/4, G3/8, G1/2	G1/4, G3/8, G1/2, G3/4	-	-	-	-	-	-	■	-	■	
		9	-	-	-	-	-	-	-	-	-	-	-	
		12	-	G1, G1 1/4, G1 1/2, G2	-	-	-	-	-	-	■	■	■	

# Membran-Lufttrockner MS-LDM1, Baureihe MS







Lieferübersicht Wartungsgeräte Baureihe MS

Typ	Bau- größe	Schalenschutz		Druckanzeige				Abschließbar- keit		Optionen		→ Seite/ Internet	
		Kunststoffschutzkorb	Metallschale	Verschlussblende (ohne Manometer)	integriertes MS-Manometer	Adapter EN-Manometer G1/8	Adapter EN-Manometer G1/4	Drucksensor	Drehknopf mit Arretie- rung, mit Zubehör abschließbar	Drehknopf mit inte- griertem Schloss	Schalldämpfer		Durchflussrichtung von rechts nach links
Code		R	U	VS	AG	A8	A4	AD...	AS	E11	S	Z	
<b>Einzelgeräte</b>													
Druckregel- ventile <b>MS-LR</b>	4	-	-	■	■	■	■	■	■	■	-	■	ms4-lr
	6	-	-	■	■	-	■	■	■	■	-	■	ms6-lr
	9	-	-	■	■	-	■	■	■	■	-	■	ms9-lr
	12	-	-	■	■	-	■	-	■	■	-	■	ms12-lr
Druckregel- ventile <b>MS-LRB</b>	4	-	-	■	■	■	■	■	■	■	-	■	ms4-lrb
	6	-	-	■	■	-	■	■	■	■	-	■	ms6-lrb
	9	-	-	-	-	-	-	-	-	-	-	-	-
	12	-	-	-	-	-	-	-	-	-	-	-	-
Präzisions- Druckregel- ventile <b>MS-LRP</b>	4	-	-	-	-	-	-	-	-	-	-	-	-
	6	-	-	■	-	■	■	■	■	■	-	■	ms6-lrp
	9	-	-	-	-	-	-	-	-	-	-	-	-
	12	-	-	-	-	-	-	-	-	-	-	-	-
Präzisions- Druckregel- ventile <b>MS-LRPB</b>	4	-	-	-	-	-	-	-	-	-	-	-	-
	6	-	-	■	-	■	■	■	■	■	-	■	ms6-lrpb
	9	-	-	-	-	-	-	-	-	-	-	-	-
	12	-	-	-	-	-	-	-	-	-	-	-	-
Elektrik-Druck- regelventile <b>MS-LRE</b>	4	-	-	-	-	-	-	-	-	-	-	-	-
	6	-	-	■	■	-	■	-	-	-	-	■	ms6-lre
	9	-	-	-	-	-	-	-	-	-	-	-	-
	12	-	-	-	-	-	-	-	-	-	-	-	-
Öler <b>MS-LOE</b>	4	■	■	-	-	-	-	-	-	-	-	■	ms4-loe
	6	■	■	-	-	-	-	-	-	-	-	■	ms6-loe
	9	-	■	-	-	-	-	-	-	-	-	■	ms9-loe
	12	-	■	-	-	-	-	-	-	-	-	■	ms12-loe
Einschalt- ventile <b>MS-EM(1)</b>	4	-	-	■	■	■	■	■	-	-	■	■	ms4-em1
	6	-	-	■	■	-	■	■	-	-	■	■	ms6-em1
	9	-	-	■	■	-	■	-	-	-	■	■	ms9-em
	12	-	-	■	■	-	■	-	-	-	■	■	ms12-em
Einschalt- ventile <b>MS-EE</b>	4	-	-	■	■	■	■	■	-	-	■	■	ms4-ee
	6	-	-	■	■	-	■	■	-	-	■	■	ms6-ee
	9	-	-	■	■	-	■	-	-	-	■	■	ms9-ee
	12	-	-	■	■	-	■	-	-	-	■	■	ms12-ee
Druckaufbau- ventile <b>MS-DL</b>	4	-	-	■	■	■	■	■	-	-	-	■	ms4-dl
	6	-	-	■	■	-	■	■	-	-	-	■	ms6-dl
	9	-	-	-	-	-	-	-	-	-	-	-	-
	12	-	-	■	■	-	■	-	-	-	-	■	ms12-dl
Druckaufbau- ventile <b>MS-DE</b>	4	-	-	■	■	■	■	■	-	-	-	■	ms4-de
	6	-	-	■	■	-	■	■	-	-	-	■	ms6-de
	9	-	-	-	-	-	-	-	-	-	-	-	-
	12	-	-	■	■	-	■	-	-	-	-	■	ms12-de

# Membran-Lufttrockner MS-LDM1, Baureihe MS

FESTO

Lieferübersicht Wartungsgeräte Baureihe MS

Typ	Bau- größe	Pneumatischer Anschluss im Gehäuse	Anschlussplatte	Performance Level		Versorgungsspannung				
				Kategorie 1, 1-Kanal	Kategorie 4, 2-Kanal mit Selbstüberwachung	24 V DC, Anschlussbild nach EN 175301	24 V DC, Anschluss M12 nach IEC 61076-2-101/ nach EN 60947-5-2	110 V AC, Anschlussbild nach EN 175301	230 V AC, Anschlussbild nach EN 175301	
Code			AG...	C	E	V24	V24P	V110	V230	
<b>Einzelgeräte</b>										
Druckaufbau- und Entlüf- tungsventile <b>MS-SV-C</b>		4	–							
		6	G1/2	G1/4, G3/8, G1/2, G3/4	■	–	■	■	■	■
		9	G3/4, G1	G1/2, G3/4, G1, G11/4, G11/2	■	–	■	■	■	■
		12	–							
Druckaufbau- und Entlüf- tungsventile <b>MS-SV-E</b>		4	–							
		6	G1/2	G1/4, G3/8, G1/2, G3/4	–	■	■	–	–	–
		9	–							
		12	–							
Membran- Lufttrockner <b>MS-LDM1</b>		4	G1/8, G1/4	G1/8, G1/4, G3/8	–	–	–	–	–	
		6	G1/4, G3/8, G1/2	G1/4, G3/8, G1/2, G3/4	–	–	–	–	–	
		9	–							
		12	–							
Abzweig- module <b>MS-FRM</b>		4	G1/8, G1/4	G1/8, G1/4, G3/8	–	–	–	–	–	
		6	G1/4, G3/8, G1/2	G1/4, G3/8, G1/2, G3/4	–	–	–	–	–	
		9	G3/4, G1	G1/2, G3/4, G1, G11/4, G11/2	–	–	–	–	–	
		12	–	G1, G11/4, G11/2, G2	–	–	–	–	–	
Verteiler- blöcke <b>MS-FRM-FRZ</b>		4	G1/4	–	–	–	–	–	–	
		6	G1/2	–	–	–	–	–	–	
		9	–							
		12	–							
Durchfluss- sensoren <b>SFAM</b>		4	–							
		6	G1/2	G1/2	–	–	–	–	–	
		9	–	G1, G11/2	–	–	–	–	–	
		12	–							

# Membran-Lufttrockner MS-LDM1, Baureihe MS

Lieferübersicht Wartungsgeräte Baureihe MS

Typ	Bau- größe	Schalenschutz		Druckanzeige					Schaltausgang		Optionen		→ Seite/ Internet
		Kunststoffschutzkorb	Metallschale	Verschlussblende (ohne Manometer)	integriertes MS-Manometer	Adapter EN-Manometer G1/8	Adapter EN-Manometer G1/4	Drucksensor	2x PNP oder NPN, 1 Analogausgang 4 ... 20 mA	2x PNP oder NPN, 1 Analogausgang 0 ... 10V	Schalldämpfer	Durchflussrichtung von rechts nach links	
Code		R	U	VS	AG	A8	A4	AD...	2SA	2SV	S	Z/R	
<b>Einzelgeräte</b>													
Druckaufbau- und Entlüf- tungsventile <b>MS-SV-C</b>	4	-											-
	6	-	-	■	■	-	■	■	-	-	■	■	ms6-sv
	9	-	-	■	■	-	■	■	-	-	■	■	ms9-sv
	12	-											-
Druckaufbau- und Entlüf- tungsventile <b>MS-SV-E</b>	4	-											-
	6	-	-	■	■	-	■	■	-	-	■	■	ms6-sv
	9	-											-
	12	-											-
Membran- Lufttrockner <b>MS-LDM1</b>	4	-	■	-	-	-	-	-	-	-	-	■	8
	6	-	■	-	-	-	-	-	-	-	-	■	8
	9	-											-
	12	-											-
Abzweig- module <b>MS-FRM</b>	4	-	-	■	■	■	■	■	-	-	-	■	ms4-frm
	6	-	-	■	■	-	■	■	-	-	-	■	ms6-frm
	9	-	-	■	■	-	■	■	-	-	-	■	ms9-frm
	12	-	-	■	-	-	-	-	-	-	-	-	ms12-frm
Verteiler- blöcke <b>MS-FRM-FRZ</b>	4	-	-	-	-	-	-	-	-	-	-	■	ms4-frm
	6	-	-	-	-	-	-	-	-	-	-	■	ms6-frm
	9	-											-
	12	-											-
Durchfluss- sensoren <b>SFAM</b>	4	-											-
	6	-	-	-	-	-	-	-	■	■	-	■	sfam-62
	9	-	-	-	-	-	-	-	■	■	-	■	sfam-90
	12	-											-

# Membran-Lufttrockner MS4/MS6-LDM1, Baureihe MS

Peripherieübersicht

## Membran-Lufttrockner MS4/MS6-LDM1

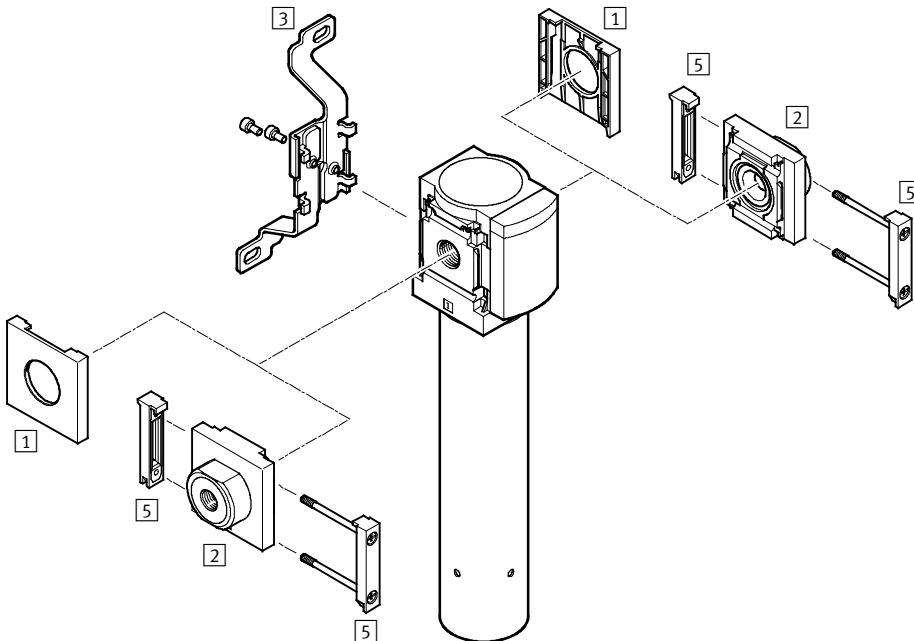

Hinweis

Weiteres Zubehör:

- Modulverbinder für Kombination mit Baugröße MS4/MS6 oder Baugröße MS9 → Internet: amv, rmv, armv
- Adapter für Montage an Profile → Internet: ipm-80, ipm-40-80, ipm-80-80

### Befestigungselemente und Zubehör

	Einzelgerät		Kombination		→ Seite/Internet
	ohne Anschlussplatte	mit Anschlussplatte	ohne Anschlussplatte	mit Anschlussplatte	
1 Abdeckkappe MS4/6-END	■	-	■	-	ms4-end, ms6-end
2 Anschlussplatte MS4/6-AG...	-	■	-	■	ms4-ag, ms6-ag
3 Befestigungswinkel MS4/6-WB	■	■	-	-	ms4-wb, ms6-wb
5 Modulverbinder MS4/6-MV	-	■	■	■	ms4-mv, ms6-mv
- Befestigungswinkel MS4-WBM	■	■	-	-	ms4-wbm
- Befestigungswinkel MS4/6-WP/WPB/WPE/WPM	-	■	■	■	ms4-wp, ms6-wp



## Membran-Lufttrockner MS4/MS6-LDM1, Baureihe MS

**FESTO**

Typenschlüssel

		MS	6	-	LDM1	-	1/2	-	P20
<b>Baureihe</b>									
MS	Wartungseinheit Standard								
<b>Baugröße</b>									
4	Rastermaß 40 mm								
6	Rastermaß 62 mm								
<b>Wartungsfunktion</b>									
LDM1	Membran-Lufttrockner								
<b>Pneumatischer Anschluss</b>									
<b>MS4</b>									
1/8	Innengewinde G1/8								
1/4	Innengewinde G1/4								
<b>MS6</b>									
1/4	Innengewinde G1/4								
3/8	Innengewinde G3/8								
1/2	Innengewinde G1/2								
<b>Durchflusspatrone</b>									
P10	Patrone P10								
P20	Patrone P20								
P40	Patrone P40								

**Weitere Varianten können Sie über den Produktbaukasten bestellen → 15**

- Anschlussplatten
- Durchflusspatrone
- Gefasste Spülluft
- Befestigungsart
- Zulassung UL
- Durchflussrichtung

# Membran-Lufttrockner MS4/MS6-LDM1, Baureihe MS

Datenblatt

Funktion

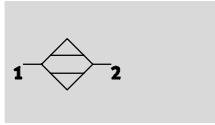

- - Durchfluss  
50 ... 400 l/min
- - Temperaturbereich  
+2 ... +50 °C
- - Betriebsdruck  
3 ... 12,5 bar

Druck-Taupunkt-Absenkung:  
20 K



- Optimaler Endstellen-Trockner mit hoher Funktionssicherheit
- Geeignet für den Einsatz als Einzelgerät oder zur Integration in bestehende Luftaufbereitungsgeräte-Kombinationen
- Durchflussabhängige Taupunktabsenkung

- Verschleißfreie Funktion ohne externe Energie
- Zusammensetzung der Druckluft bleibt durch den Trocknungsprozess nahezu unverändert
- 15% Spülluftrate
- Optionaler Spülring zum Fassen der Spülluft

Typische Einsatzgebiete:

- Trocknung, Reinigung von Präzisionsteilen
- Messtechnik
- Spülung von Glasmaßstäben
- Lackieranlagen
- Papier- und Verpackungsmaschinen

Hinweis

Für die einwandfreie Funktion des Gerätes ist die Vorfiltrierung der Druckluft mit Feinstfilter MS-LFM-A, Filterfeinheit 0,01 µm (Restpartikel < 0,1 µm, Restölgehalt < 0,1 mg/m<sup>3</sup>) unbedingt erforderlich!

Allgemeine Technische Daten					
Baugröße	MS4		MS6		
Pneumatischer Anschluss 1, 2	G1/8	G1/4	G1/4	G3/8	G1/2
Konstruktiver Aufbau	Membrantrockner mit Eigenluftverbrauch				
Befestigungsart	mit Zubehör				
	Leitungseinbau				
Einbaulage	senkrecht ±5°				
Luftreinheitsklasse am Ausgang	Druckluft nach ISO 8573-1:2010 [1:3:2]				

Hinweis: Dieses Produkt entspricht ISO 1179-1 und ISO 228-1.

Normaldurchfluss q <sub>n</sub> <sup>1)</sup> [l/min]					
Baugröße	MS4		MS6		
	Patrone P05	Patrone P10	Patrone P20	Patrone P30	Patrone P40
Eingang q <sub>n Ein</sub>	59	118	235	353	471
Ausgang q <sub>n Aus</sub>	50	100	200	300	400
Spülluft q <sub>n Purge</sub>	8,8	17,6	35,3	52,9	70,6

1) Gemessen bei p<sub>1</sub> = 6,9 bar, θ<sub>pd Ein</sub> = 25 °C, θ<sub>pd Aus</sub> = 5 °C ± 1,5 °C (θ<sub>pa Aus</sub> = -21,5 °C ± 1,2 °C), θ<sub>amb</sub> = 25 °C

## Membran-Lufttrockner MS4/MS6-LDM1, Baureihe MS

Datenblatt

Betriebs- und Umweltbedingungen	
Betriebsdruck [bar]	3 ... 12,5 (3 ... 10) <sup>1)</sup>
Betriebsmedium	Druckluft nach ISO 8573-1:2010 [1:4:2]
Hinweis zum Betriebs-/ Steuermedium	geölter Betrieb nicht möglich
Druck-Taupunkt-Absenkung [K]	20
Umgebungstemperatur [°C]	+2 ... +50
Mediumstemperatur [°C]	+2 ... +50
Lagertemperatur [°C]	-20 ... +60
Korrosionsbeständigkeit KBK <sup>2)</sup>	2
Zulassung UL	c UL us - Recognized (OL)

1) Wert in Klammern gilt für MS4/MS6-LDM1 mit Zulassung UL.

2) Korrosionsbeständigkeitsklasse 2 nach Festo Norm 940 070

Bauteile mit mäßiger Korrosionsbeanspruchung. Außenliegende sichtbare Teile mit vorrangig dekorativer Anforderung an die Oberfläche, die im direkten Kontakt zur umgebenden industriellen Atmosphäre bzw. Medien, wie Kühl- und Schmierstoffe stehen.

Gewichte [g]					
Baugröße	MS4		MS6		
	Patrone P05	Patrone P10	Patrone P20	Patrone P30	Patrone P40
Membran-Lufttrockner	420	530	1 050	1 200	1 300

### Werkstoffe

Funktionsschnitt

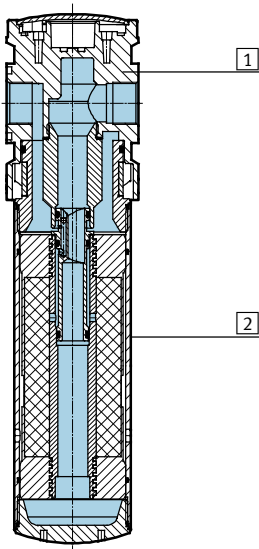

Membran-Lufttrockner	
1	Gehäuse Aluminium-Druckguss
2	Schale Aluminium-Knetlegierung
-	Dichtungen NBR
Werkstoff-Hinweis RoHS konform	

# Membran-Lufttrockner MS4/MS6-LDM1, Baureihe MS

Datenblatt

## Drucktaupunkt $t_{pd}$ (Ausgang) in Abhängigkeit vom Normaldurchfluss am Ausgang $q_n$ <sup>1)</sup>

MS4-LDM1-...-P05

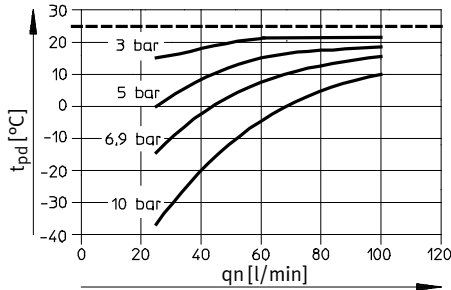

MS4-LDM1-...-P10

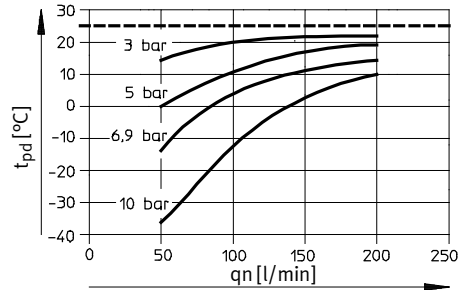

MS6-LDM1-...-P20

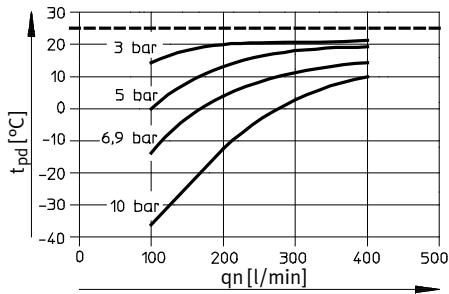

MS6-LDM1-...-P30

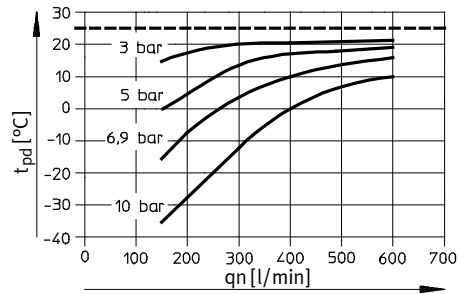

MS6-LDM1-...-P40

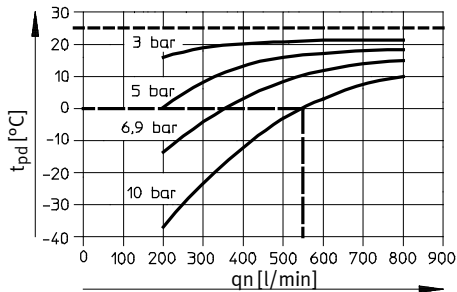

- 1) Gemessen bei Drucktaupunkt  $t_{pd}$  (Eingang) = 25 °C.
- Beispiel MS6-LDM1-...-P40 mit 10 bar Betriebsdruck:  
bei einem Normaldurchfluss von  $q_n = 550$  l/min beträgt  
die Drucktaupunkt-Absenkung 25 K.

# Membran-Lufttrockner MS4/MS6-LDM1, Baureihe MS

Datenblatt

**FESTO**

## Differenzdruck $\Delta p$ in Abhängigkeit vom Normaldurchfluss am Ausgang $q_n$

MS4-LDM1-...-P05

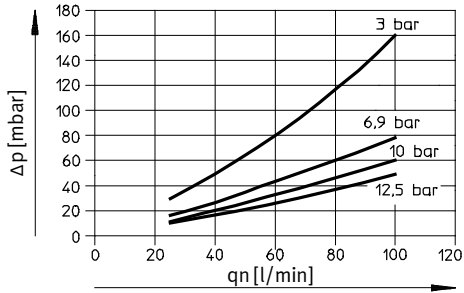

MS4-LDM1-...-P10

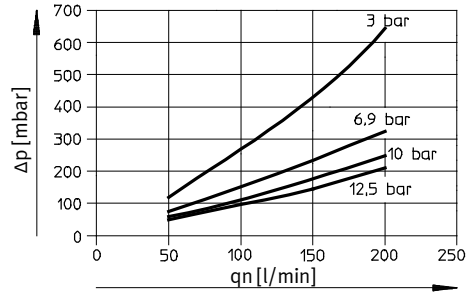

MS6-LDM1-...-P20

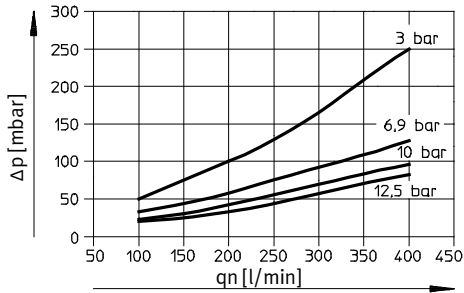

MS6-LDM1-...-P30

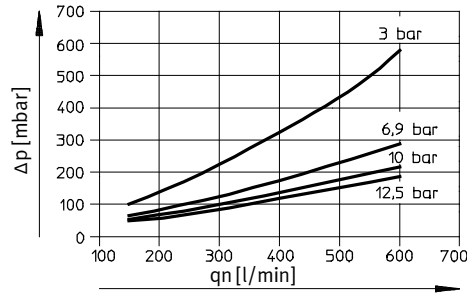

MS6-LDM1-...-P40

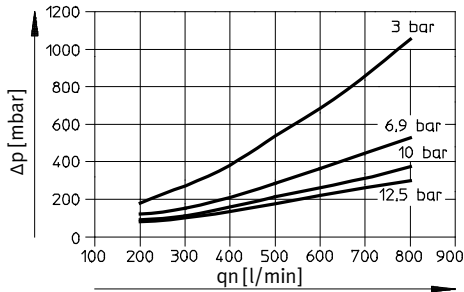

# Membran-Lufttrockner MS4/MS6-LDM1, Baureihe MS

Datenblatt

## Abmessungen

Download CAD-Daten → [www.festo.com](http://www.festo.com)

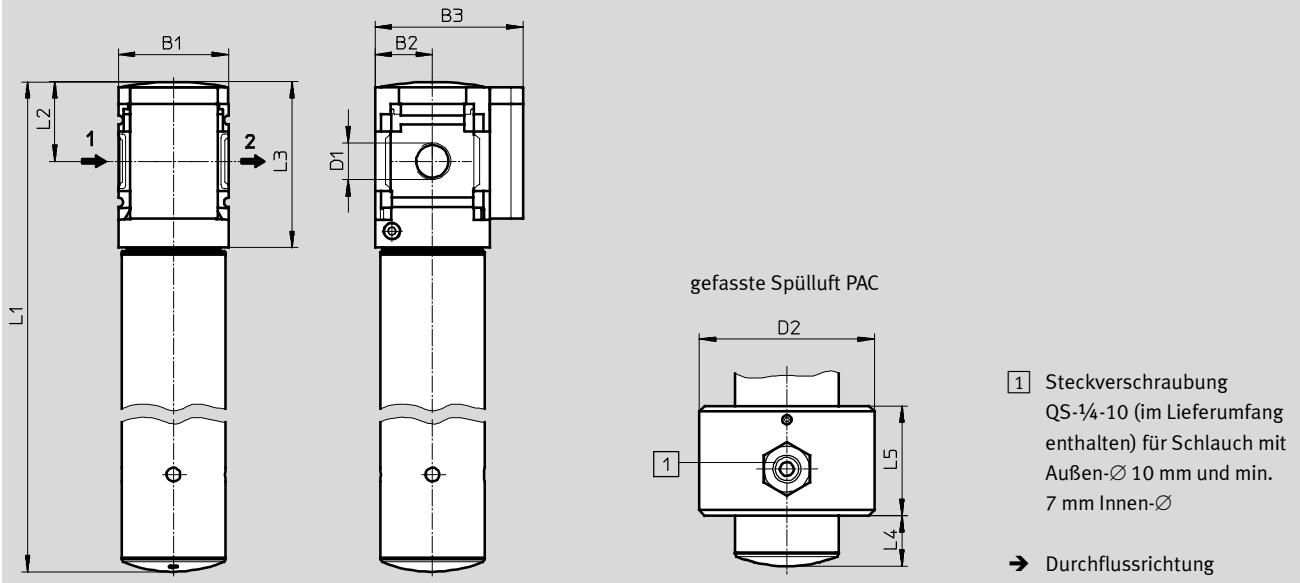

- 1 Steckverschraubung QS-1/4-10 (im Lieferumfang enthalten) für Schlauch mit Außen-Ø 10 mm und min. 7 mm Innen-Ø

→ Durchflussrichtung

Typ	B1	B2	B3	D1	D2	L1	L2	L3	L4	L5
MS4-LDM1-1/8-P05	40	21	54	G1/8	64	245	29	60	18	40
MS4-LDM1-1/8-P10						345				
MS4-LDM1-1/4-P05	40	21	54	G1/4	64	245	29	60	18	40
MS4-LDM1-1/4-P10						345				
MS6-LDM1-1/4-P20	62	31	76	G1/4	80	345	42	87	34	40
MS6-LDM1-1/4-P30						415				
MS6-LDM1-1/4-P40						475				
MS6-LDM1-3/8-P20	62	31	76	G3/8	80	345	42	87	34	40
MS6-LDM1-3/8-P30						415				
MS6-LDM1-3/8-P40						475				
MS6-LDM1-1/2-P20	62	31	76	G1/2	80	345	42	87	34	40
MS6-LDM1-1/2-P30						415				
MS6-LDM1-1/2-P40						475				

Hinweis: Dieses Produkt entspricht ISO 1179-1 und ISO 228-1.

## Bestellangaben

Baugröße	Durchflussspatrone	Anschluss	Teile-Nr.	Typ
MS4	P10	G1/8	<b>543630</b>	<b>MS4-LDM1-1/8-P10</b>
		G1/4	<b>543632</b>	<b>MS4-LDM1-1/4-P10</b>
MS6	P20	G1/4	<b>543640</b>	<b>MS6-LDM1-1/4-P20</b>
		G3/8	<b>543642</b>	<b>MS6-LDM1-3/8-P20</b>
		G1/2	<b>543644</b>	<b>MS6-LDM1-1/2-P20</b>
	P40	G1/4	<b>543646</b>	<b>MS6-LDM1-1/4-P40</b>
		G3/8	<b>543648</b>	<b>MS6-LDM1-3/8-P40</b>
		G1/2	<b>543650</b>	<b>MS6-LDM1-1/2-P40</b>

# Membran-Lufttrockner MS4/MS6-LDM1, Baureihe MS

**FESTO**

Bestellangaben – Produktbaukasten

M Mindestangaben					O Optionen				
Baukasten-Nr.	Bau-reihe	Bau-größe	Funktion	Pneuma-tischer Anschluss	Durch-fluss-patrone	Spülluft	Befesti-gungsart	Zulassung UL	Durch-flussrich-tung
543628 543638	MS	4 6	LDM1	1/8, 1/4, 3/8, 1/2 AGA, AGB, AGC, AGD, AGE	P05 P10 P20 P30 P40	PAC	WP WPM WB WBM	UL1	Z
<b>Bestell-beispiel</b>									
<b>543628</b>	<b>MS</b>	<b>4</b>	<b>- LDM1</b>	<b>- AGC</b>	<b>- P10</b>	<b>-</b>	<b>- WP</b>	<b>-</b>	<b>-</b>

Bestelltablelle						
Rastermaß	[mm]	40	62	Bedin-gungen	Code	Eintrag Code
M	Baukasten-Nr.	<b>543628</b>		<b>543638</b>		
	Baureihe	Standard			<b>MS</b>	MS
	Baugröße	4	6		...	
	Funktion	Membrantrockner			<b>-LDM1</b>	-LDM1
	Pneumatischer Anschluss	Innengewinde G1/8		-	-1/8	
		Innengewinde G1/4		Innengewinde G1/4	-1/4	
		-		Innengewinde G3/8	-3/8	
		-		Innengewinde G1/2	-1/2	
		Anschlussplatte G1/8		-	<b>-AGA</b>	
		Anschlussplatte G1/4		Anschlussplatte G1/4	<b>-AGB</b>	
		Anschlussplatte G3/8		Anschlussplatte G3/8	<b>-AGC</b>	
		-		Anschlussplatte G1/2	<b>-AGD</b>	
	Durchflusspatrone	50 l/min		-	<b>-P05</b>	
		100 l/min		-	<b>-P10</b>	
		-		200 l/min	<b>-P20</b>	
		-		300 l/min	<b>-P30</b>	
		-		400 l/min	<b>-P40</b>	
O	Spülluft	gefasste Spülluft			<b>-PAC</b>	
	Befestigungsart	Befestigungswinkel		1	<b>-WP</b>	
		Befestigungswinkel		1	<b>-WPM</b>	
		Befestigungswinkel			<b>-WB</b>	
		Befestigungswinkel		-	<b>-WBM</b>	
	Zulassung UL	cULus, ordinary location for Canada and USA			<b>-UL1</b>	
	Durchflussrichtung	Durchflussrichtung von rechts nach links			<b>-Z</b>	

1 WP, WPM Nur mit Anschlussplatte AGA, AGB, AGC, AGD oder AGE

Übertrag Bestellcode

**MS**  - **LDM1**  -  -  -  -  -  -  -