

Valve terminals type 03 VIMP-/VIFB-03, multi-functional MIDI/MAXI

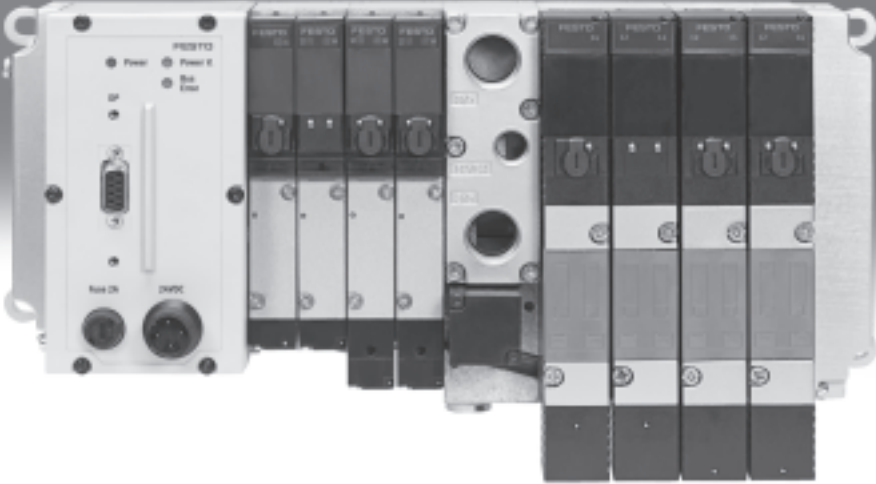

- 1 - Type to be discontinued
Available until 2012

Valve terminals type 03 VIMP-/VIFB-03, multi-functional MIDI/MAXI

FESTO

Key features



Innovative

- Multi-functional valve terminal in sturdy metal housing
- Electrical interlinking module for flexible expansion options

Standardised system of electrical connections:

- Multi-pin plug
- All common fieldbuses
- Integrated controllers for pre-processing

Suitable for electrical peripherals type 03 and CPX, i.e.:

- Diagnostics down to the individual valve
- Parameterisable error characteristics
- Separate load voltage supply for valves
- On-site diagnostics via LEDs or handheld terminal CPX (MMI)

Versatile

- Modular system offering a range of configuration options
 - Expandable up to 26 solenoid coils and 12 I/O modules
 - Conversions and extensions possible at a later date
 - Simple replacement of valves and valve functions
 - High pressure range -0.9 ... 10 bar
 - Wide range of valve functions
 - Multiple pressure zones
- Vertical stacking modules:
- Pressure regulator
 - Flow control plates

Reliable

Sturdiness:

- Metal valve housing
- Metal I/O module housing
- Electrical connection technology
- Fast troubleshooting thanks to LEDs on the valves and diagnostics via fieldbus
- Reliability of service through replaceable valves
- Manual override either non-detenting, detenting or covered
- Flexible labelling system thanks to inscription labels

In combination with CPX:

- Module and channel-specific diagnostics
- Comprehensive diagnostics on-site without PC, only with CPX-MMI

Easy to mount

- Ready-to-install and tested unit
- Sturdy mounting and version for harsh environments
- Lower selection, ordering, assembly and commissioning costs
- Wall mounting or H-rail mounting

Valve terminals type 03 VIMP-/VIFB-03, multi-functional MIDI/MAXI

Key features

Valve terminals type 03

Valve terminals are the most comprehensive system in intelligent pneumatics.

The multi-functional Festo valve terminals for MIDI/MAXI valves have a sturdy, modular design and they can be equipped with different valve sizes. A valve terminal can also have multiple pressure zones and vacuum operation as well as integrated pressure regulators and one-way flow control valves. The valve terminals are therefore

capable of providing versatile and flexible solutions to a wide variety of pneumatic control technology requirements, and the high-quality metal/plastic design and protection to IP65 mean that they can be effective even in the harshest operating environments.

A worldwide service and consultation network round off the performance spectrum.

Multi-pin plug variants

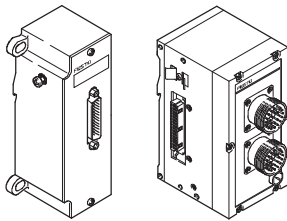

Valve terminals with multi-pin plug connections can be connected in the normal way to the I/O cards of all current control systems or industrial PCs. The central control system requires a

powerful PLC with a correspondingly high number of I/O cards and must also be connected to the fieldbus devices with more complex parallel wiring.

Festo offers several installation-saving multiple connection nodes and the appropriate multi-pin cables.

Connection types

Multi-pin plug

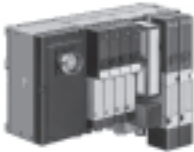

Round multi-pin plug connection, sturdy version for up to 24 solenoid coils.

Double multi-pin plug



Double round multi-pin plug connection for connecting up to 6 digital input modules for sensors.

Sub-D multi-pin plug connection

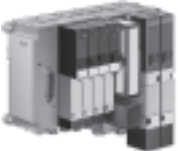

Sub-D multi-pin plug connection with protection to IP65, low-cost and flat, for up to 22 solenoid coils.

Control block with electrical I/O modules



Integrated controller and fieldbus interface, I/O modules as with fieldbus connection. Decentralised CP systems can also be connected.

Fieldbus node with electrical I/O modules



Communication and diagnostics with all common bus systems:

- Up to 12 sturdy type 03 I/O modules can be assembled
- Connection technology to IP65 with M12 or Sub-D plugs
- Digital I/O modules
- Analogue I/O modules
- Multi-functional I/O modules
- 2 A outputs for hydraulic valves

- 1 - Type to be discontinued
Available until 2012

FESTO

Valve terminals type 03 VIMP-/VIFB-03, multi-functional MIDI/MAXI

Key features

User documentation – GSD, EDS, etc.

Device description files and icons are used to explain the integration of the valve terminal type 03 in the configuration software of the various controller manufacturers.

These can be downloaded quickly and conveniently from the download area of the Festo website.

→ www.festo.com



Valve terminal configurator

Online via: → www.festo.com

The appropriate type 03 valve terminal can be chosen quickly and easily using the online catalogue. This includes an easy-to-use valve terminal configurator, which makes it much easier to order the right product.

The valve terminals are fully assembled according to your order specification and are individually tested. This reduces assembly and installation time to a minimum.

You order a valve terminal type 03 using the order code.

Ordering system for pneumatic components

→ Internet: type 03

Ordering system for electrical components

→ Internet: type 03, type 04

Valve terminals type 03 VIMP-/VIFB-03, multi-functional MIDI/MAXI

Peripherals overview

Electrical components



Flexible connection to the controller thanks to an extensive range of connection nodes:

- Multi-pin plug connection
- Fieldbus connection
- DeviceNet direct interface

Stand-alone solutions with integrated PLC (control block) from:

- Festo
- Allen Bradley

Electrical digital inputs/outputs:

- Max. 12 modules in combination with suitable nodes (see ordering data)
- Inputs for 24 V DC sensors, PNP or NPN outputs for small consuming devices 24 V DC
- High-current outputs up to 2 A PNP/NPN, for example for hydraulic valves, can be connected directly to the valve terminal

Proportional pneumatics:

- Analogue modules optimised for proportional valves, for example for Festo MPYE and MPPES for regulating the force of a cylinder
- To detect, control/regulate universal analogue variables (4 ... 20 mA or 0 ... 10 V) within the process – on-site to IP65

Optimising and expanding your application:

- Modules for installation-saving connection using sturdy Sub-D plugs to IP65
- Low-cost connections to input/output stations and operator units
- AS-interface master for connection to decentralised inputs/outputs covering an extensive range, for example in conveyor systems (type to be discontinued, do not use for new projects)
- Modules for connecting decentralised CPV and CPA valve terminals
- Extensions and supplements can be added at any time

Easy mounting:

- On H-rail
- On mounting surface
- With covers in welding environments

Simple servicing:

- LED display
- Manual override

Easy maintenance thanks to clip-on inscription fields.

Convenient diagnostics via fieldbus connection and integrated PLC:

- Status bits
- Diagnostic bits
- Integrated self-test

Detailed information on electrical peripherals:

→ Internet: type 03

- 1 - Type to be discontinued
Available until 2012

FESTO

Valve terminals type 03 VIMP-/VIFB-03, multi-functional MIDI/MAXI

Peripherals overview

Pneumatic components

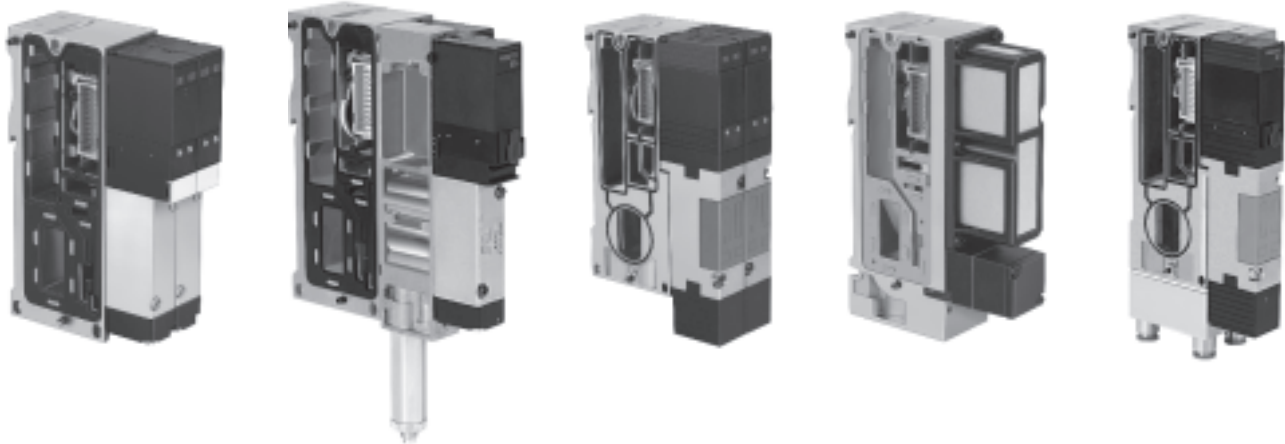

Midi modules:

- Manifold block for two MIDI valves
- 500 l/min
- Up to cylinder diameter 63 mm

Maxi modules:

- Manifold block for two MAXI valves
- 1,250 l/min
- Up to cylinder diameter 80 mm

Valve actuation:

- All valves have an external pilot air supply and are therefore suitable for vacuum operation
- If the entire valve terminal is to be operated with a vacuum, the pilot air supply must be regulated and supplied externally
- If the pilot air supply is generated via one of the valve terminal's regulators, working pressure of > 4 bar must be applied to this compressed air supply
- All valves with non-detenting/detenting/blocked manual override (on request)

Additional modules:

- One-way flow control valves for setting the speed of travel separately with single and double-acting cylinders
- One-way flow control valves and pressure regulators can be fitted at working lines
- Intermediate pressure regulator plates for setting the contact pressure of a cylinder either at channel 1 or separately at channel 2 or 4

Flexible compressed air supply:

- Right-hand end plate with regulator for pilot air and flat plate silencer
- Additional compressed air supply with ducted exhaust air or integrated flat plate silencer
- Compressed air supply modules without regulator with externally regulated pilot air
- Multiple pressure zones, including vacuum, are possible for all valve sizes

Options:

- Vacant positions for subsequent extensions
- All connections also supplied with preassembled QS fittings (on request)
- All connections can also be supplied with an NPT thread

Service:

- Multiple valve sizes can be combined on a single terminal
- All valves can be replaced quickly and easily
- All valves are supplied with 1 or 2 LEDs
- All valves are ready for identification clips
- Flat design thanks to flat plate silencer
- Online valve terminal configurator available in the electronic catalogue or on the Internet

Valve terminals type 03 VIMP-/VIFB-03, multi-functional MIDI/MAXI

Peripherals overview

Multi-functional valve terminal

Components

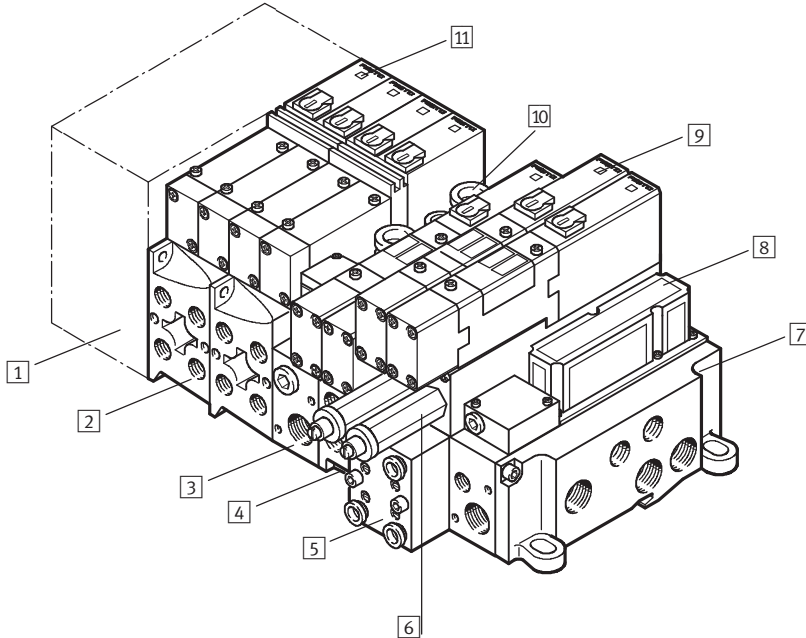

- 1 Multi-pin node/fieldbus node/control block
- 2 Manifold block, size 4.0 (MIDI)
- 3 Adapter plate, size 4.0 to size 7.0, with regulator for auxiliary pilot air
- 4 Manifold block, size 7.0 (MAXI)
- 5 One-way flow control valve
- 6 Pressure regulator
- 7 Right-hand end plate
- 8 Additional compressed air supply with integrated silencer
- 9 Solenoid valve size 7.0 type MTH, JMTH
- 10 Port for ducted exhaust air
- 11 Solenoid valve size 4.0 type MT2H, JMT2H

Description

Valve terminals type 03 permit the combination of multiple valve sizes. This assures optimal adaptation to system requirements. The valves have a nominal size of 4.0 mm and 7.0 mm.

The transition from nominal size 4.0 mm (MIDI) to nominal size 7.0 mm

(MAXI) is made with an adapter plate. The adapter plate can only be used once in any given system. The MIDI valves must be mounted directly next to the nodes, followed by the MAXI valves.

Order:

- Nodes
- MIDI valves

- Adapter plate
- MAXI valves
- End plate

If no MIDI valves are used, the adapter plate must still be installed between the node and the first sub-base for MAXI valves.

Only valves with separate pilot air supply are used. Pilot pressure is supplied either via the adapter plate or the right-hand end plate. In either case, the maximum permissible pilot pressure is 5 bar. To limit the pilot pressure, special pressure regulators are provided on the adapter plate or the right-hand end plate.

Creating pressure zones

General information

A valve terminal can have multiple pressure zones and vacuum operation as well as integrated pressure regulators and one-way flow control valves.

For more than two pressure zones, multiple "compressed air supplies" or isolating discs can be combined. The isolating disc can only be inserted into a normal manifold block and not into the supply block.

MIDI

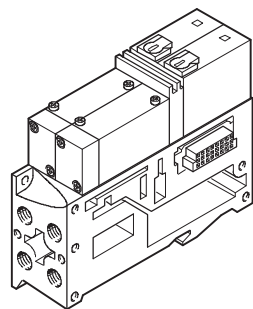

With MIDI valves, pressure zones for different pressures (including vacuum) are created via a "pressure zone supply" block.

The lower pressures should be supplied closest to the node.

MAXI

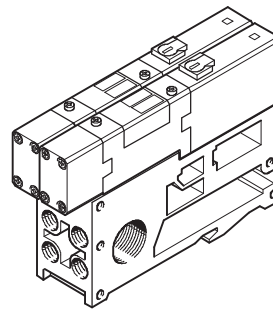

With MAXI valves, pressure zones are created by inserting an isolating disc. Air is then supplied via the adapter plate.

Additional power supply

 Note
For valve terminals with more than ten valves and large-volume cylinders, at least one additional compressed air supply should be provided.

-  - Type to be discontinued
Available until 2012

Valve terminals type 03 VIMP-/VIFB-03, multi-functional MIDI/MAXI

Peripherals overview

FESTO

Vacuum operation

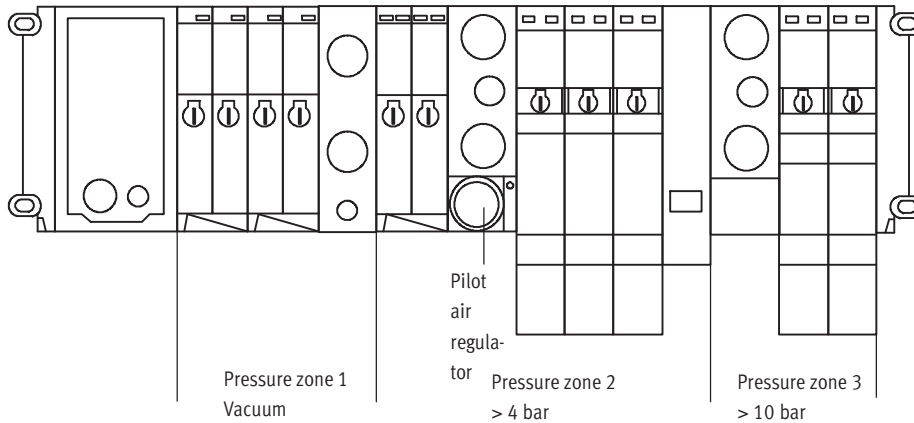

 Note

If auxiliary pilot air is generated via one of the valve terminal's regulators, working pressure of > 4 bar must be applied to this compressed air supply.

If the entire valve terminal is to be operated with a vacuum, the pilot air supply must be regulated and supplied externally.

A filter must be installed upstream of valves operated in vacuum mode. This prevents any foreign matter in the intake air getting into the valve (e.g. when operating a suction cup).

Vertical stacking

General information

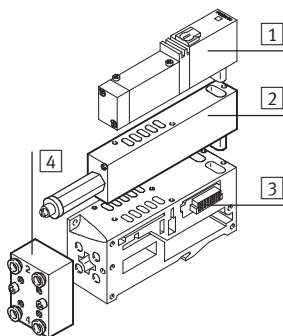

- 1 Solenoid valve
- 2 Pressure regulator
- 3 Manifold block
- 4 One-way flow control valve

Pressure regulator

A pressure regulator can be installed between the sub-base and the valve to influence the force of the actuated cylinder. There are three variants available:

- Regulation in port 1 (P)
- Regulation in port 2 (B)
- Regulation in port 4 (A)

One-way flow control valve

A block with one-way flow control valves can be mounted on the front of the sub-base to influence the speed of the controlled cylinder.

A block always contains 4 one-way flow control valves.

Pressure regulator at port 1 (P)

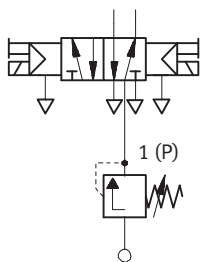

ILR-0,3-ZP-P-4,0
ILR-0,3-ZP-P-7,0

Pressure regulator at port 2 (B)

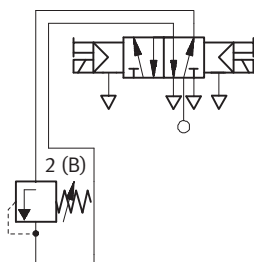

ILR-0,3-ZP-B-4,0
ILR-0,3-ZP-B-7,0

Pressure regulator at port 4 (A)

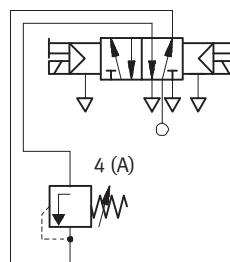

ILR-0,3-ZP-A-4,0
ILR-0,3-ZP-A-7,0

One-way flow control valve

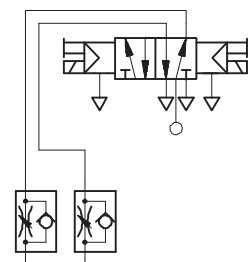

IGR-0,3-AP-A/B-QS-6
IGR-0,3-AP-A/B-QS-8

Valve terminals type 03 VIMP-/VIFB-03, multi-functional MIDI/MAXI

Instructions for use

Equipment

Operate system equipment with unlubricated compressed air if possible. Festo valves and cylinders are designed so that, if used as designated, they will not require additional lubrication and will still achieve a long service life. The quality of compressed air downstream of the compressor must correspond to that of unlubricated compressed air. If possible, do not operate all of your system equipment with lubricated compressed air. The lubricators should, where possible, always be installed directly upstream of the actuator used.

Incorrect additional oil and too high an oil content in the compressed air reduce the service life of the valve terminal.

Use Festo special oil OFSW-32 or the alternatives listed in the Festo catalogue (as specified in DIN 51 524 HLP32; basic oil viscosity 32 CST at 40 °C).

Bio-oils

When using bio-oils (oils which are based on synthetic or native ester, e.g. rapeseed oil methyl ester), the maximum residual oil content of 0.1 mg/m³ must not be exceeded (see ISO 8573-1 Class 2).

Mineral oils

When using mineral oils (e.g. HLP oils to DIN 51 524, parts 1 to 3) or similar oils based on poly-alpha-olefins (PAO), the maximum residual oil content of 5 mg/m³ must not be exceeded (see ISO 8573-1 Class 4). A higher residual oil content irrespective of the compressor oil cannot be permitted, as the basic lubricant would be flushed out over time.

Welding environment

Valve terminal type 03 has a high-quality metal/plastic design.

Suitable covers should be used to prevent the terminal being damaged as a result of welding spatter.

-  - Type to be discontinued
Available until 2012

Valve terminals type 03 VIMP-/VIFB-03, multi-functional MIDI/MAXI

FESTO

Technical data – Valve terminal type 03 MIDI

-  - Flow rate up to
Type 03 MIDI:
300 ... 500 l/min
Type 03 MAXI:
1,250 l/min

-  - Valve width
Type 03 MIDI: 18 mm
Type 03 MAXI: 25 mm

-  - Voltage
24 V DC



General technical data – Type 03 MIDI						
Valve function	5/2-way valve			5/3-way valve		
	With pneumatic spring and pilot air supply	With mechanical spring	Double solenoid valve with pilot air supply	Mid-position closed with pilot air supply	Mid-position exhausted with pilot air supply	Mid-position pressurised with pilot air supply
Valve function order code	M, Y	L, Z	J	G	E	B
Design	Piston spool valve					
Width [mm]	18					
Nominal size [mm]	4.0					
Lubrication	Lubrication for life, silicon-free					
Type of mounting	On MIDI/MAXI valve terminal with 2 combi screws					
Mounting position	Any					
Manual override	Detenting					
Nominal flow rate [l/min]	500	500	500	500	300	300

Pressure ranges [bar]						
Valve function order code	M, Y	L, Z	J	G	E	B
Operating pressure	-0.9 ... +10					
Operating pressure for valve terminal with internal pilot air supply	4 ... 8					
Pilot pressure	4 ... 6					

Valve switching times [ms]							
Valve function order code	M, Y	L, Z	J	G	E	B	
Switching times	On	12	10	-	12	12	12
	Off	22	26	-	25	25	25
	Change-over	-	-	10	-	-	-
Min. switching impulse	-	-	7	-	-	-	

Valve terminals type 03 VIMP-/VIFB-03, multi-functional MIDI/MAXI

Technical data – Valve terminal type 03 MIDI

Ambient conditions	
Operating medium	Filtered compressed air, lubricated or unlubricated → 9
Grade of filtration [µm]	40
Storage temperature [°C]	-20 ... +40
Ambient temperature [°C]	-5 ... +50
Temperature of medium [°C]	-5 ... +50
Corrosion resistance class CRC ¹⁾	2

- 1) CRC2: Corrosion resistance class 2 according to Festo standard 940 070
Components subject to moderate corrosion stress. Externally visible parts with primarily decorative surface requirements which are in direct contact with a normal industrial environment or media such as coolants or lubricating agents.

Electrical data	
Protection against electric shock (protection against direct and indirect contact to EN 60204-1/IEC 204)	By means of PELV power supply unit
Operating voltage [V DC]	24 (+10/-15%)
Electrical power consumption per solenoid coil [W]	1.5
Protection class to EN 60529	IP65 (for all types of signal transmission in assembled state)
Vibration resistance	To DIN/IEC 68/EN 60068, Parts 2-6 • With wall mounting: severity level 2 • With H-rail mounting: severity level 1
Shock resistance	To DIN/IEC 68/EN 60068, Parts 2-27 • With wall mounting: severity level 2 • With H-rail mounting: severity level 1

- 1) The maximum signal line length is 10 m

Materials	
Housing	Die-cast aluminium
Cap	Polyacetate, polyetheretherketone (PEEK), polyamide, steel
Seals	Nitrile rubber

Weight [g]	
End plate without connections	120
Input modules	360
Multi-pin node	580
Blanking plate	60
Bus node	Approx. 1,000
Output modules	400
Manifold block	300
Valve	140 ... 160
Pressure regulator	100
One-way flow control valve	120

- 1 - Type to be discontinued
Available until 2012

Valve terminals type 03 VIMP-/VIFB-03, multi-functional MIDI/MAXI

FESTO

Technical data – Valve terminal type 03 MAXI

General technical data – Type 03 MAXI					
Valve function	5/2-way valve			5/3-way valve	
	With pneumatic spring and pilot air supply	Double solenoid valve with pilot air supply	Mid-position closed with pilot air supply	Mid-position exhausted with pilot air supply	Mid-position pressurised with pilot air supply
Valve function order code	M, Y	J	G	E	B
Design	Piston spool valve				
Width [mm]	25				
Nominal size [mm]	7				
Lubrication	Lubrication for life, silicon-free				
Type of mounting	On MIDI/MAXI valve terminal with 2 combi screws				
Mounting position	Any				
Manual override	Detenting				
Nominal flow rate [l/min]	1,300				

Pressure ranges [bar]					
Valve function order code	M, Y	J	G	E	B
Operating pressure	-0.9 ... +10				
Operating pressure for valve terminal with internal pilot air supply	4 ... 8				
Pilot pressure	4 ... 6				

Valve switching times [ms]						
Valve function order code	M, Y	J	G	E	B	
Switching times	On	25	–	25	25	25
	Off	30	–	55	55	55
	Change-over	–	18	–	–	–
Min. switching impulse	10	10	10	10	10	

Ambient conditions	
Operating medium	Filtered compressed air, lubricated or unlubricated → 9
Grade of filtration [µm]	50
Storage temperature [°C]	-20 ... +40
Ambient temperature [°C]	-5 ... +50
Temperature of medium [°C]	-5 ... +50
Corrosion resistance class CRC ¹⁾	2

- 1) CRC2: Corrosion resistance class 2 according to Festo standard 940 070
Components subject to moderate corrosion stress. Externally visible parts with primarily decorative surface requirements which are in direct contact with a normal industrial environment or media such as coolants or lubricating agents.

Valve terminals type 03 VIMP-/VIFB-03, multi-functional MIDI/MAXI

Technical data – Valve terminal type 03 MAXI

Electrical data	
Protection against electric shock (protection against direct and indirect contact to EN 60204-1/IEC 204)	By means of PELV power supply unit
Operating voltage [V DC]	24 (+10/-15%)
Electrical power consumption per solenoid coil [W]	2.2
Protection class to EN 60529	IP65 (for all types of signal transmission in assembled state)
Vibration resistance	To DIN/IEC 68/EN 60068, Parts 2-6 <ul style="list-style-type: none"> • With wall mounting: severity level 2 • With H-rail mounting: severity level 1
Shock resistance	To DIN/IEC 68/EN 60068, Parts 2-27 <ul style="list-style-type: none"> • With wall mounting: severity level 2 • With H-rail mounting: severity level 1

1) The maximum signal line length is 10 m

Materials	
Housing	Die-cast aluminium
Cover	Polyacetate, polyetheretherketone (PEEK), polyamide, steel
Seals	Nitrile rubber

Weight [g]	
End plate without connections	435
Input modules	360
Multi-pin node	580
Blanking plate	63
Bus node	Approx. 1,000
Output modules	400
Manifold block	552
Valve	Approx. 313
Pressure regulator	188
One-way flow control valve	237

Connections

Adapter plate	End plate	Pressure supply plate	Pressure zone supply module
---------------	-----------	-----------------------	-----------------------------

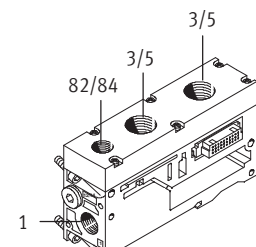
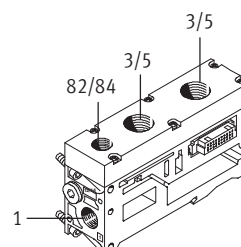
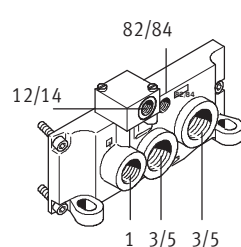
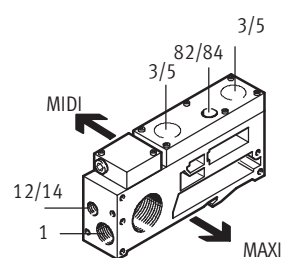

Connection	1	3/5	12/14	82/84	Valves
MIDI	G $\frac{3}{8}$	G $\frac{1}{2}$	G $\frac{1}{8}$	G $\frac{1}{8}$	G $\frac{1}{8}$
MAXI	G $\frac{1}{2}$	G $\frac{1}{2}$	G $\frac{1}{4}$	G $\frac{1}{4}$	G $\frac{1}{4}$

-  - Type to be discontinued
Available until 2012

Valve terminals type 03 VIMP-/VIFB-03, multi-functional MIDI/MAXI

FESTO

Technical data – Valve terminal type 03, multi-pin plug

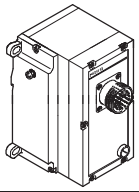
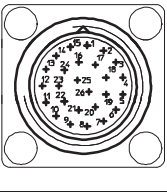
Pin allocation – Multi-pin node with round plug MP1								
View	Pin - plug	Wire - cable 14 wires	Wire - cable 26 wires	Solenoid coil ¹⁾				
				Type PNP		Type NPN		
				Coil	Voltage	Coil	Voltage	
		1 ... 12	1 ... 12	0 ... 11	24 V	0 ... 11	0 V	
		13 ... 24	–	12 ... 23	24 V	12 ... 23	0 V	
		25 ... 26	13 ... 14	25 ... 26	–	0 V (supply voltage)	–	24 V (supply voltage)

1) Counting mode for solenoid coils: starting from the multi-pin node from left to right and from top to bottom continuously.

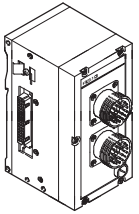
Pin allocation – Multi-pin node with round plug MP2							
View	Pin - plug	Wire - cable 26 wires	Type PNP		Type NPN		
			Coil	Supply voltage	Coil	Supply voltage	
	Plug on top	1 ... 12	1 ... 24	Solenoid coil ¹⁾ 0 ... 23	–	Solenoid coil ¹⁾ 0 ... 23	–
		25 ... 26	25 ... 26	–	0 V	–	24 V
	Plug on underside	1 ... 8	1 ... 8	Input ²⁾ 0 ... 7	–	Input ²⁾ 0 ... 7	–
		9	9	–	0 V	–	24 V
		10	10	–	24 V	–	0 V
		25 ... 26	25 ... 26	Input ²⁾ 8 ... 23	–	Input ²⁾ 8 ... 23	–

1) Counting mode for solenoid coils: starting from the multi-pin node from left to right and from top to bottom continuously.

2) Counting mode for inputs: starting from the multi-pin node from left to right and from top to bottom continuously.
The 8-valve input module has two inputs on one terminal socket.

Valve terminals type 03 VIMP-/VIFB-03, multi-functional MIDI/MAXI

FESTO

Technical data – Valve terminal type 03, multi-pin plug

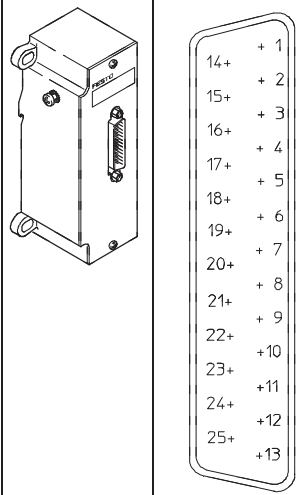
Pin allocation – Multi-pin node with Sub-D plug MP4					
View	Pin - plug	R/3 - pin	Signal		
			Positive switching	Negative switching	
	1	A1	VSP0	VSP0	
	2	A2	VSP1	VSP1	
	3	B1	VSP2	VSP2	
	4	B2	VSP3	VSP3	
	5	C1	VSP4	VSP4	
	6	C2	VSP5	VSP5	
	7	A3	VSP6	VSP6	
	8	A4	VSP7	VSP7	
	9	B3	VSP8	VSP8	
	10	B4	VSP9	VSP9	
	11	C3	VSP10	VSP10	
	12	C4	VSP11	VSP11	
	13	A5	VSP12	VSP12	
	14	A6	VSP13	VSP13	
	15	B5	VSP14	VSP14	
	16	B6	VSP15	VSP15	
	17	C5	VSP16	VSP16	
	18	C6	VSP17	VSP17	
	19	A7	VSP18	VSP18	
	20	A8	VSP19	VSP19	
	21	B7	VSP20	VSP20	
	22	B8	VSP21	VSP21	
	23	C7	-	-	
	24	C10	0 V	24 V	
	25	B10	0 V	24 V	
Housing	A10	-	Earthing		
Housing	A9	-	Earthing		

-  - Type to be discontinued
Available until 2012

Valve terminals type 03 VIMP-/VIFB-03, multi-functional MIDI/MAXI

FESTO

Technical data – Valve terminal type 03 MIDI/MAXI

Dimensions

Download CAD data → www.festo.com

Valve terminal type 03 with multi-pin plug connection MP1

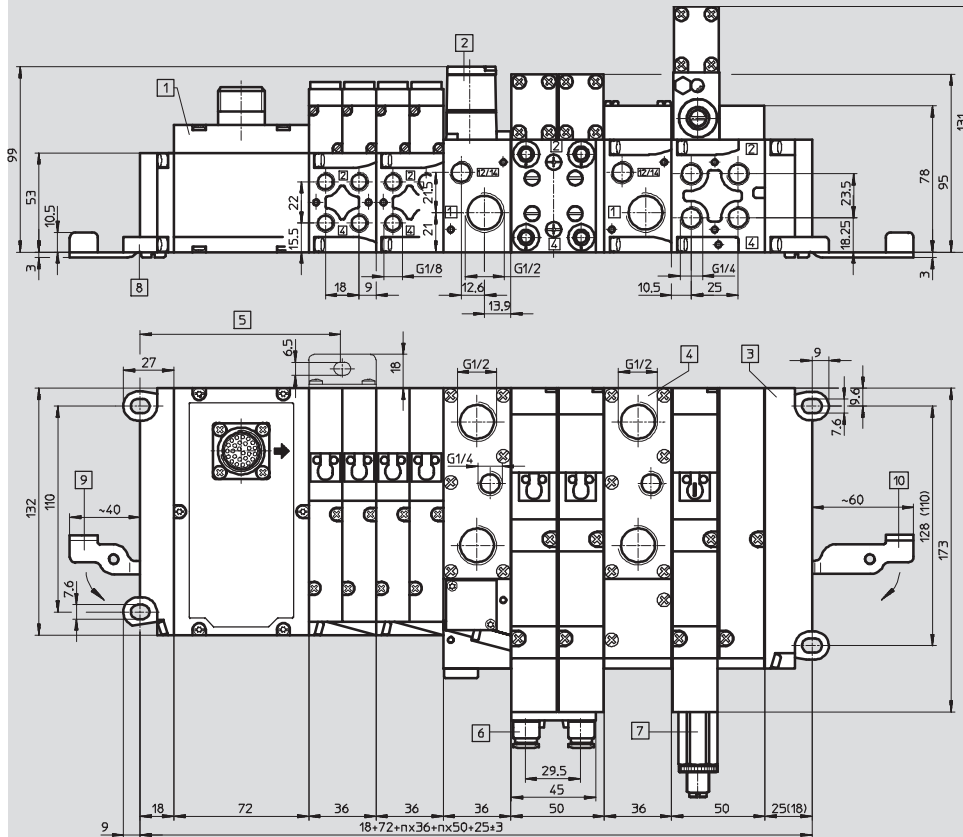

- | | | | |
|---|--|--|---|
| 1 Multi-pin node MP1 with round plug | 4 Pressure supply plate | 7 Pressure regulator | 10 Swivel bracket IBGH-03-7,0 (opened out) for connection to mounting rail |
| 2 Adapter plate MIDI + MAXI with pressure regulator for pilot pressure | 5 Mounting bracket (required every 200 mm with wall mounting) | 8 Left-hand end plate | |
| 3 Right-hand end plate | 6 One-way flow control valve | 9 Swivel bracket IBGH-03-4,0 (opened out) for connection to mounting rail | |

Valve terminals type 03 VIMP-/VIFB-03, multi-functional MIDI/MAXI

Technical data – Valve terminal type 03 MIDI/MAXI

Dimensions

Download CAD data → www.festo.com

Valve terminal type 03 with multi-pin plug connection MP4

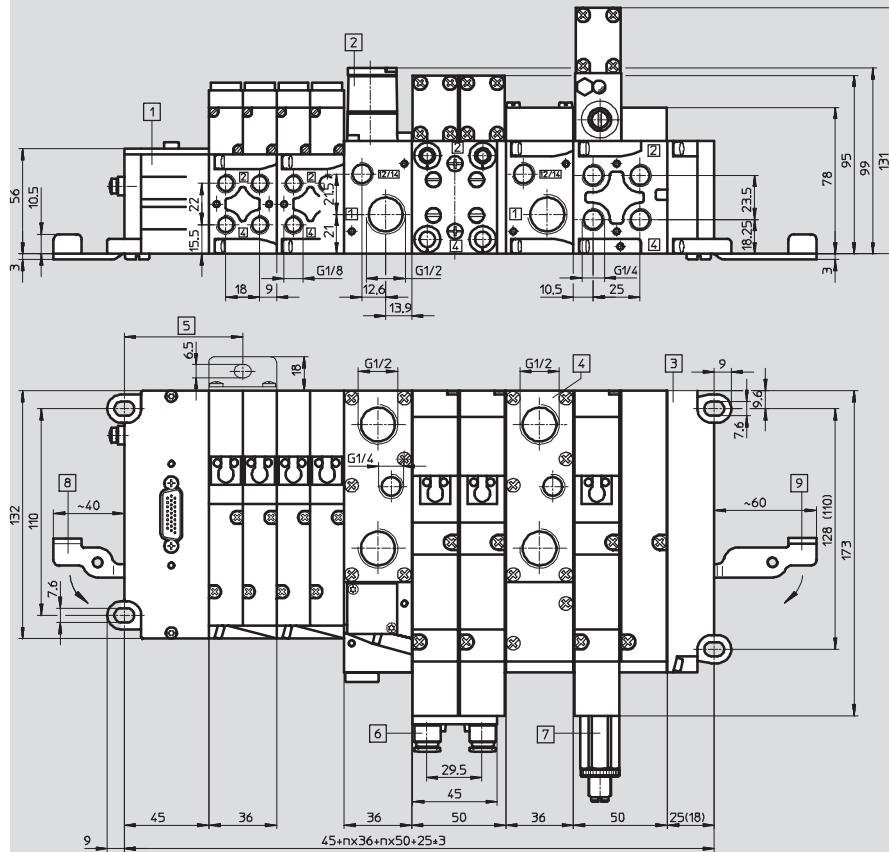

- | | | | |
|--|---|---|---|
| 1 Multi-pin node with Sub-D plug | 4 Compressed air supply plate | 7 Pressure regulator | 9 Swivel bracket IBGH-03-7,0
(opened out) for connection to
mounting rail |
| 2 Adapter plate MIDI + MAXI with
pressure regulator for pilot
pressure | 5 Mounting bracket
(required every 200 mm with
wall mounting) | 8 Swivel bracket IBGH-03-4,0
(opened out) for connection to
mounting rail | |
| 3 Right-hand end plate | 6 One-way flow control valve | | |

-  - Type to be discontinued
Available until 2012

Valve terminals type 03 VIMP-/VIFB-03, multi-functional MIDI/MAXI

Technical data – Valve terminal type 03 MIDI/MAXI

FESTO

Dimensions

Download CAD data → www.festo.com

Valve terminal type 03 with multi-pin plug connection MP2

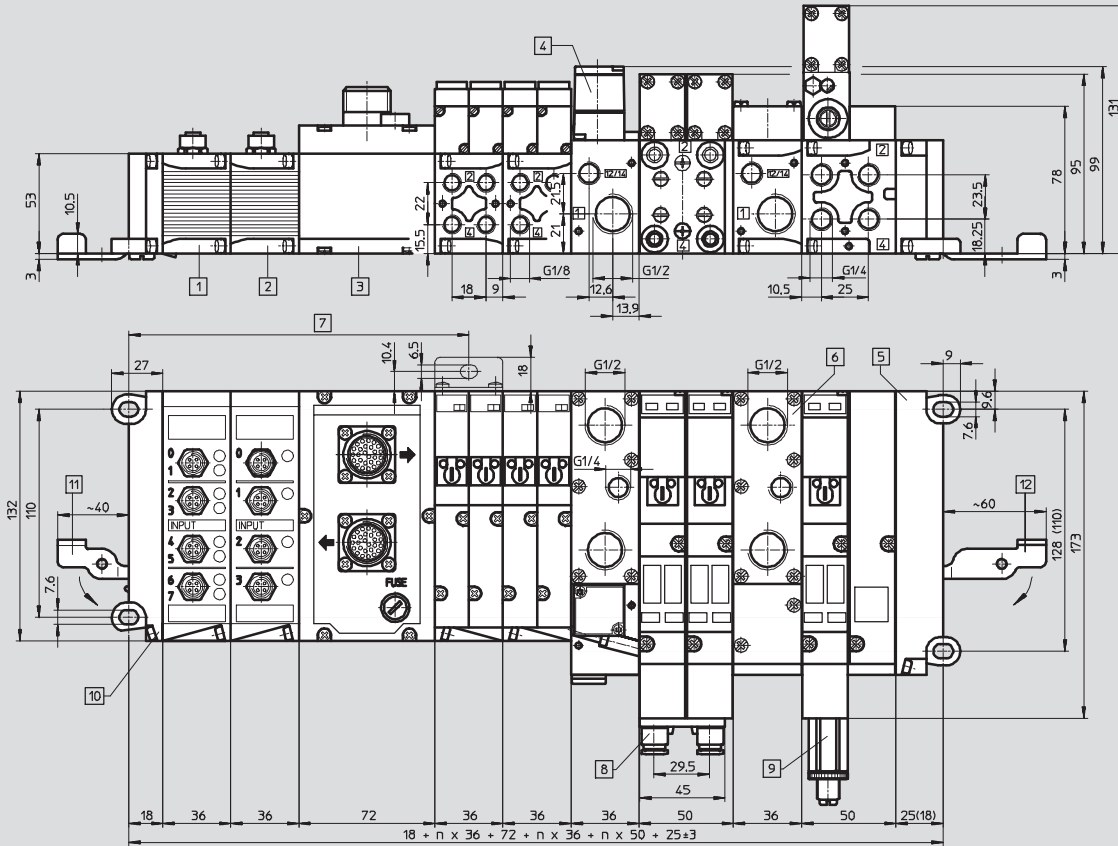

- | | | | |
|--|---|--|--|
| 1 8-valve input module | 5 Right-hand end plate | 9 Pressure regulator | 12 Swivel bracket IBGH-03-7,0
(opened out) for connection to
mounting rail |
| 2 4-valve input module | 6 Compressed air supply plate | 10 End plate, left-hand | |
| 3 Multi-pin node MP2 with round
plug | 7 Mounting bracket
(required every 200 mm with
wall mounting) | 11 Swivel bracket IBGH-03-4,0
(opened out) for connection to
mounting rail | |
| 4 Adapter plate MIDI/MAXI with
pressure regulator for pilot
pressure | 8 One-way flow control valve | | |

- 2 - Type to be discontinued
Available until 2012

FESTO

Valve terminals type 03 VIMP-/VIFB-03, multi-functional MIDI/MAXI

Technical data – Valve terminal type 03 MIDI/MAXI end plate

Dimensions

Download CAD data → www.festo.com

End plate, MIDI valves

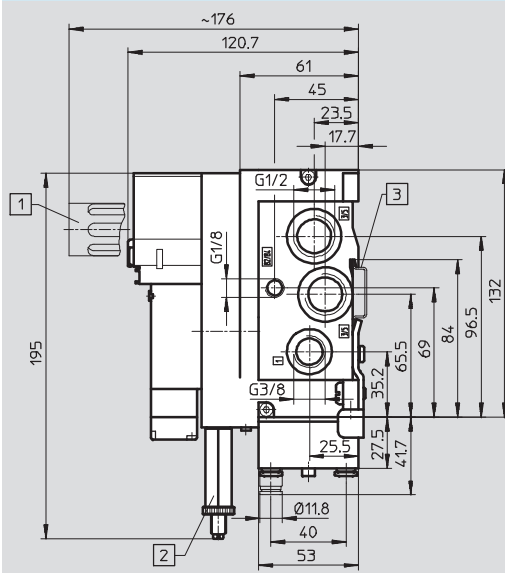

- 1 Silencer
- 2 Pressure regulator
- 3 H-rail

End plate, MAXI valves

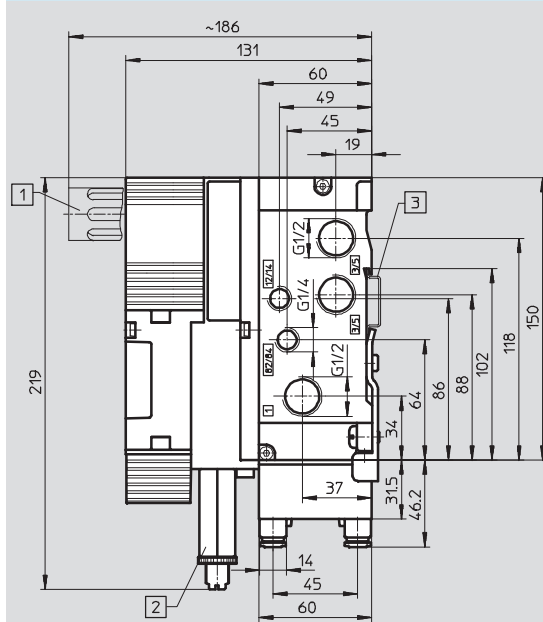

- 1 Silencer
- 2 Pressure regulator
- 3 H-rail

- 1 - Type to be discontinued
Available until 2012

FESTO

Valve terminals type 03 VIMP-/VIFB-03, multi-functional MIDI/MAXI

Technical data – Adjustable four-fold one-way flow control valve for MIDI/MAXI valves

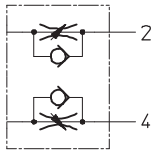

- Compact valve manifold
- Direct attachment to the manifold block

These valves are used to regulate air flow, for example to control the piston speeds of single or double-acting cylinders. Non-return valves block air flow in one direction. Air is only able to flow via the cross section which is adjusted with the throttle screw. Air flows freely in the other direction through the open non-return valve.



General technical data			
Type		IGR-03-A-P-A/B-QS-6 (MIDI)	IGR-03-A-P-A/B-QS-8 (MAXI)
Part No.		164947	164948
Design	Flow control valve	Annular gap	
	Non-return function	Pressure relief gasket	
Width	[mm]	36	50
Nominal size	[mm]	4.0	7.0
Type of mounting		On MIDI/MAXI valve terminal with 2 combi screws	
Mounting position		Any	
Ambient temperature	[°C]	-10 ... +60	
Temperature of medium	[°C]	-10 ... +60	
Operating medium		Filtered compressed air, lubricated or unlubricated → 9	
Operating pressure	[bar]	0.3 ... +10	
Nominal flow rate in flow control direction, flow control valve open ¹⁾	[l/min]	270	570
Nominal flow rate in return direction, flow control valve open ¹⁾	[l/min]	270	550
Nominal flow rate in return direction, flow control valve closed	[l/min]	200	350
Weight	[g]	120	237

1) 10 turns

Materials	
Housing	Aluminium
Regulating screws	Brass
Seals	Nitrile rubber

Valve terminals type 03 VIMP-/VIFB-03, multi-functional MIDI/MAXI

FESTO

Technical data – Adjustable four-fold one-way flow control valve for MIDI/MAXI valves

Control characteristic

Type IGR-03-...

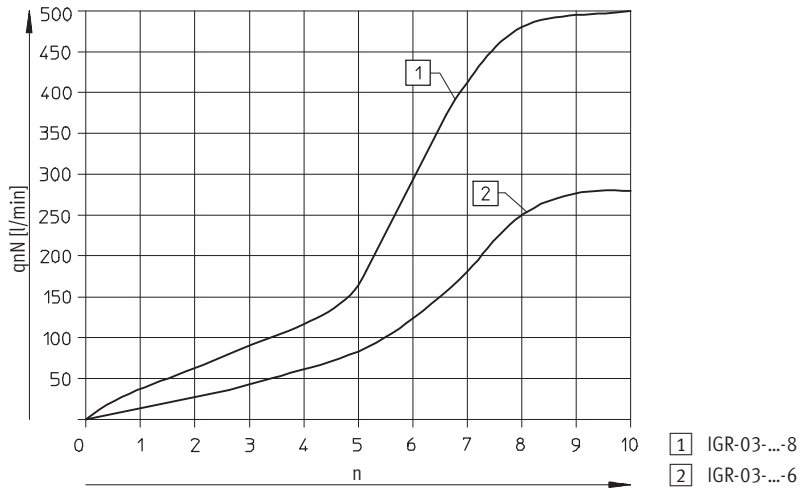

- 1 - Type to be discontinued
Available until 2012

FESTO

Valve terminals type 03 VIMP-/VIFB-03, multi-functional MIDI/MAXI

Technical data – Pressure regulator for MIDI/MAXI valves

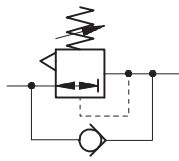

An adjustable pressure regulator can be installed between the sub-base and the valve in order to control the force of the actuated cylinder. This pressure regulator maintains an essentially constant output pressure (secondary side) independent of pressure fluctuations (primary side) and air consumption.



General technical data (MIDI)			
Type	ILR-03-ZP-P-4,0	ILR-03-ZP-A-4,0	ILR-03-ZP-B-4,0
Part No.	164941	164943	164945
Design	Piston regulator		
Width [mm]	18		
Nominal size [mm]	4.0		
Type of mounting	On MIDI/MAXI valve terminal with 2 combi screws		
Mounting position	Any		
Ambient temperature [°C]	-10 ... +60		
Temperature of medium [°C]	-10 ... +60		
Operating medium	Filtered compressed air, lubricated or unlubricated → 9		
Supply pressure [bar]	0 ... +10		
Output pressure [bar]	0 ... +8		
Weight [g]	100		

General technical data (MAXI)			
Type	ILR-03-ZP-P-7,0	ILR-03-ZP-A-7,0	ILR-03-ZP-B-7,0
Part No.	164942	164944	164946
Design	Piston regulator		
Width [mm]	25		
Nominal size [mm]	7.0		
Type of mounting	On MIDI/MAXI valve terminal with 2 combi screws		
Mounting position	Any		
Ambient temperature [°C]	-10 ... +60		
Temperature of medium [°C]	-10 ... +60		
Operating medium	Filtered compressed air, lubricated or unlubricated → 9		
Supply pressure [bar]	0 ... +10		
Output pressure [bar]	0 ... +8		
Weight [g]	188		

Materials	
Housing	Aluminium
Seals	Nitrile rubber

Valve terminals type 03 VIMP-/VIFB-03, multi-functional MIDI/MAXI

Technical data – Pressure regulator for MIDI/MAXI valves

Components

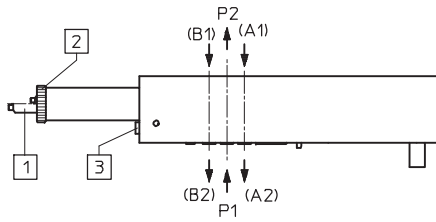

- 1 Pressure adjustment screw for 0 ... 8 bar range
- 2 Lock nut
- 3 Pressure indicator connection:
 - M3 (MIDI)
 - M5 (MAXI)

Flow rate characteristic

MIDI

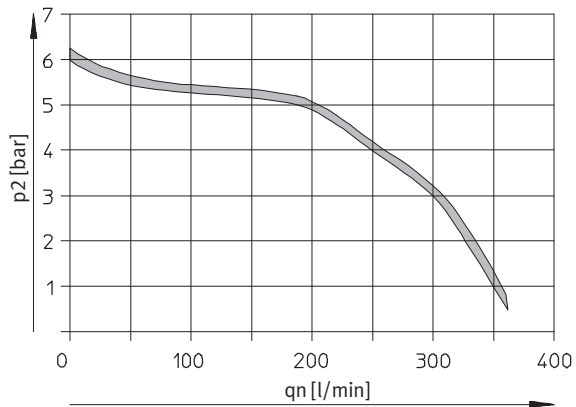

MAXI

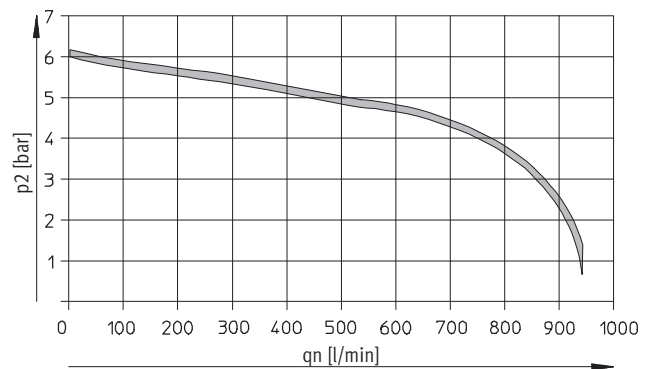

-  - Type to be discontinued
Available until 2012

Valve terminals type 03 VIMP-/VIFB-03, multi-functional MIDI/MAXI

Technical data – Input module for multi-pin node

FESTO

- Max. 24 inputs
- Input module for 24 V DC sensor signals
- M12 plug, single allocation connection technology with 4-valve modules, double allocation connection technology with 8-valve modules
- M12 plug, 4-pin
- The input statuses are indicated for each input signal on an assigned LED
- 24 V DC voltage supplied for all connected sensors
- Module width: 36 mm



Application

Application	Overall power requirement	Sensor operation	
Input modules enable the connection of cylinder sensors or other 24 V DC sensors (inductive, capacitive, etc.). Plugs with double allocation are separated using a DUO plug or DUO cable.	The overall power requirement for all connected sensors on a valve terminal must not exceed 2 A.	If negative switching sensors are used, 24 V DC and 0 V DC must be swapped on the multi-pin node, i.e. 24 V DC must be applied to pin 3 on the sensor socket and 0 V DC must be applied to pin 1.	Pin allocations must therefore be checked before the sensors are connected. Positive switching sensors and negative switching sensors cannot be used together.

General technical data (MIDI)

Type Part No.	VIGE-03-MP-4 18 672	VIGE-03-MP-8 18 657
No. of inputs	4	8
No. of occupied module positions	1	
Sensor connection type	4 x M12, 4-pin socket with single allocation	Socket with double allocation
Max. power supply per channel [A]	2	
Max. sensor supply per module [A]	2	
Fuse protection for sensor supply	Central fuse 2 A, on system supply	
Sensor supply voltage [V DC]	24 ± 10%, coming from multi-pin node	
Ambient temperature [°C]	-5 ... +50	
Storage temperature [°C]	-20 ... +60	
Material	Die-cast aluminium	
Protection class to EN 60 529	IP65	
Dimensions [mm]	42 x 70 x 132	
Weight [g]	360	

-  - Note

The input module for multi-pin node MP4/8 can only be used with the multi-pin variants of the valve terminal type 03. It cannot be used with type VIFB-03.

Valve terminals type 03 VIMP-/VIFB-03, multi-functional MIDI/MAXI

Technical data – Input module for multi-pin node

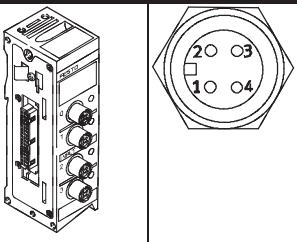
Pin allocation – Inputs with multi-pin node							
View	Plug (from top to bottom)	Pin	MP4		MP8		
			Allocation	LED	Allocation	LED	
	1	1	24 V	0	24 V	0	
		2	Free		lx +1		
		3	0 V		0 V		1
		4	lx		lx		
	2	1	24 V	1	24 V	2	
		2	Free		lx +1		
		3	0 V		0 V		3
		4	lx +1		lx +2		
	3	1	24 V	2	24 V	4	
		2	Free		lx +1		
		3	0 V		0 V		5
		4	lx +2		lx +4		
	4	1	24 V	3	24 V	6	
		2	Free		lx +1		
		3	0 V		0 V		7
		4	lx +3		lx +4		

- 1 - Type to be discontinued
Available until 2012

Valve terminals type 03 VIMP-/VIFB-03, multi-functional MIDI/MAXI



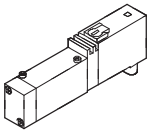
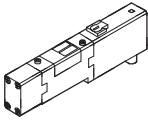
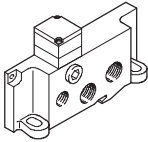
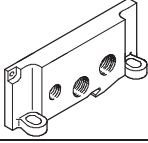
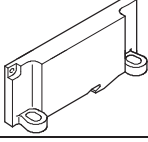
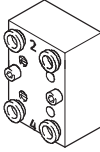
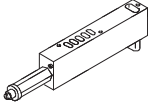

FESTO

Ordering data – Accessories

Ordering data				
	Code	Description	Type	Part No.
Solenoid valves MIDI				
	M/Y	5/2-way valve, single solenoid, pneumatic spring return	MT2H-5/2-4,0-L-S-VI-B	159 452
	L/Z	5/2-way valve, single solenoid, mechanical spring return	MT2H-5/2-4,0-S-VI-B	159 454
	J	5/2-way valve, double solenoid	JMT2H-5/2-4,0-S-VI-B	159 453
	B	5/3-way valve, mid-position pressurised	MT2H-5/3B-4,0-S-VI-B	159 450
	E	5/3-way valve, mid-position exhausted	MT2H-5/3E-4,0-S-VI-B	159 449
	G	5/3-way valve, mid-position closed	MT2H-5/3G-4,0-S-VI-B	159 448
Solenoid valves MAXI				
	M/Y	5/2-way valve, single solenoid, pneumatic spring return	MTH-5/2-7,0-L-S-VI	151 700
	J	5/2-way valve, double solenoid	JMTH-5/2-7,0-S-VI	151 701
	B	5/3-way valve, mid-position pressurised	MTH-5/3B-7,0-S-VI	151 704
	E	5/3-way valve, mid-position exhausted	MTH-5/3E-7,0-S-VI	151 703
	G	5/3-way valve, mid-position closed	MTH-5/3G-7,0-S-VI	151 702
Right-hand end plate				
	R	With regulator MIDI	IEPR-03-4,0-LR	18 781
	H	Without regulator MIDI	IEPR-03-4,0-P	18 645
	H	Without regulator MAXI	IEPR-03-7,0-P	18 744
	E	Without connections MIDI	IEPR-03-4,0	175 205
	E	Without connections MAXI	IEPR-03-7,0	18 749
	One-way flow control valve			
	Q	One-way flow control valve MIDI	IGR-03-AP-A/B-QS-6	164 947
	Q	One-way flow control valve MAXI	IGR-03-AP-A/B-QS-8	164 948
Pressure regulator				
	P	Port P MIDI	ILR-03-ZP-P-4,0	164 941
	P	Port P MAXI	ILR-03-ZP-P-7,0	164 942
	R	Port A MIDI	ILR-03-ZP-A-4,0	164 943
	R	Port A MAXI	ILR-03-ZP-A-7,0	164 944
	T	Port B MIDI	ILR-03-ZP-B-4,0	164 945
	T	Port B MAXI	ILR-03-ZP-B-7,0	164 946

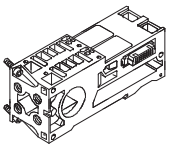
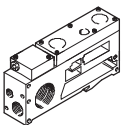
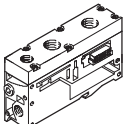
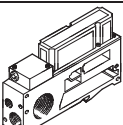
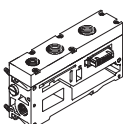
Valve terminals type 03 VIMP-/VIFB-03, multi-functional MIDI/MAXI

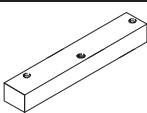
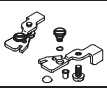
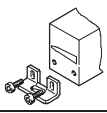
Ordering data – Accessories





Ordering data				
	Code	Description	Type	Part No.
Manifold block				
		Single solenoid MIDI	VIGM-03-4,0	18 652
		Single solenoid MAXI	VIGM-03-7,0	18 742
		Double solenoid MIDI	VIGI-03-4,0	18 653
		Double solenoid MAXI	VIGI-03-7,0	18 743
Adapter plate				
	XX	MIDI/MAXI	VIGP-03-7,0-4,0-LR	18 748
	WW	Without regulator	VIGP-03-7,0-4,0	18 740
	DD	Compressed air supply MIDI	VIGP-03-4,0	18 654
	DD	Compressed air supply MAXI	VIGP-03-7,0	18 741
	HH	Compressed air supply with silencer MIDI	VIGP-03-4,0-U	525 433
	HH	Compressed air supply with silencer MAXI	VIGP-03-7,0-U	525 435
	NN	MIDI/MAXI with silencer	VIGP-03-7,0-4,0-U	525 436
	FF	MIDI/MAXI with regulator and silencer	VIGP-03-7,0-4,0-LR-U	525 437
	UU	Additional pressure zone MIDI	VIGZ-03-4,0	18 638
	VV	Additional pressure zone MIDI with silencer	VIGZ-03-4,0-U	525 434
Flat plate silencer				
		Flat plate silencer MIDI	IU-03-4,0	165 635
		Flat plate silencer MAXI	IU-03-7,0	165 636
Cover				
	C	Cover plate MIDI	IAP-03-4,0	18 648
	A	Cover plate MAXI	IAP-03-7,0	18 745
Mounting				
	B	For H-rail MIDI	IBGH-03-4,0	18 649
	B	For H-rail MAXI	IBGH-03-7,0	18 747
	W	Mounting bracket	IBGW-03	18 678
Small parts				
	S	Isolating disc MAXI	NSC-1/2-03-7,0	18 746
		Inscription labels 9x20 in frames (20 pieces)	IBS-9x20	18 182
		Inscription labels 10x17 in frames (30 pieces)	IBS-10x17	160 238

- 1 - Type to be discontinued
Available until 2012

Valve terminals type 03 VIMP-/VIFB-03, multi-functional MIDI/MAXI

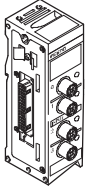
FESTO

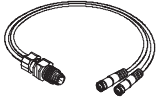
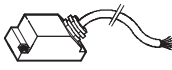
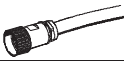
Ordering data – Accessories

Ordering data				
	Code	Description	Type	Part No.
Modules				
	F	Multi-pin input module, 4-valve	VIGE-03-MP-4	18 672
	E	Multi-pin input module, 8-valve	VIGE-03-MP-8	18 657
Plug				
	S	Plug, straight socket, M12, 4-pin, PG7	SEA-GS-7	18 666
	W	4-pin, 2.5 mm ² O.D.	SEA-4GS-7-2,5	192 008
	X	Plug for 2 connecting cables, M12, PG11, 4-pin	SEA-GS-11-DUO	18 779
Cable				
		DUO cable, 2x straight socket	KM12-DUO-M8-GDGD	18 685
		DUO cable, straight/angled socket	KM12-DUO-M8-GDWD	18 688
		DUO cable, 2x angled socket	KM12-DUO-M8-WDWD	18 687
Multi-pin plug connection				
	H	Connecting cable for multi-pin node MP4, with Sub-D connection, 5 m	KEA-1-25P-5	177 413
	J	Connecting cable for multi-pin node MP4, with Sub-D connection, 10 m	KEA-1-25P-10	177 414
		Connecting cable for multi-pin node MP4, with Sub-D connection, x length	KEA-1-25P-X	177 415
		Connecting cable, 26-pin, for inputs, 10 m	KMP2-03-E-10-26	175 665
		Connecting cable, 26-pin, for valves, 10 m	KMP2-03-V-10-26	175 667
	E	Plug socket for multi-pin node MP2, 25-pin	SD-SUB-D-BU25	18 709
	Y	Multi-pin plug socket for multi-pin node MP2, for valves	IMP2-SD-26-V	18 664
	Q	Multi-pin plug socket for multi-pin node MP2, for inputs/outputs	IMP2-SD-26-EA	18 665

- 1 - Type to be discontinued
Available until 2012

Valve terminals type 03 VIMP-/VIFB-03, multi-functional MIDI/MAXI

FESTO

Ordering data – Accessories

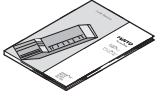
Ordering data					
	Description	Allocation	Language	Type	Part No.
Manual					
	Manual for valve terminals type 03	Type 03 Pneumatics MIDI/MAXI	German	PBE-MIDI/MAXI-03-DE	152 770
			English	PBE-MIDI/MAXI-03-EN	152 771
			Spanish	PBE-MIDI/MAXI-03-ES	163 917
			French	PBE-MIDI/MAXI-03-FR	163 937
			Italian	PBE-MIDI/MAXI-03-IT	165 441
			Swedish	PBE-MIDI/MAXI-03-SV	165 471