

- Flexible and robust design
- Tried and trusted Tiger valves
- Wide choice of variants:
Multi-pin, fieldbus or integrated PLC
- Valve/sensor terminal with electrical inputs and two additional electrical outputs
- Relay outputs, upon request

-  - Type discontinued
Available up until 2010

FESTO

Valve terminal type 02 VIMP/IIMP-02, Tiger 2000

Features

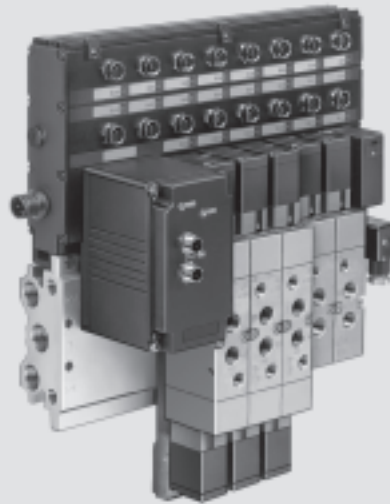

Valve/sensor terminal type 02 with Tiger valves

Reliable, flexible and sturdy:

For many years now the Tiger valve terminal type 02 has been the emblem for the world-wide success of intelligent pneumatics. The invention of valve terminals began with the Tiger series valves and they are still a success.

The success factors are a relatively flexible and sturdy design with many useful detail solutions and an unbeatable range of control variants.

The valve terminals are supplied fully checked and only need to be attached with 4 bolts – ready to go.

- Valve terminals with 4 to 16 valve positions, equipped according to customer requirements.
- Connection sizes:
 - G $\frac{1}{8}$
 - G $\frac{1}{4}$
- Valve/sensor terminal: Valve terminal with two sensor inputs per valve position and two additional universal inputs and two outputs per terminal (24 V/0.5 A).

- Protection class IP 65
- Fully assembled and 100 % tested before shipment.
- Sturdy Tiger valves, proven reliability.
- Long service life, even in aggressive environments.
- LED display and integrated protective circuit for each solenoid

-  - Note

Technical data on fieldbuses and control blocks can be found under Modular electrical peripherals type 03/04.

→ Internet: type 03

Valve terminal type 02 VIMP/IIMP-02, Tiger 2000

Features

General features

Separate voltage supply for electronics and outputs. Outputs can be switched off separately.

There is an option for using relay plates, blanking plates for spare positions and sealing plugs for two different pressure zones.

The manifold contains common lines for compressed air supply, exhaust

and pilot exhaust for all valves. The common lines can be connected on both sides.

Manual override, LED for status display per valve and sensor input, integrated self-test function and diagnosis messages (with fieldbus nodes) allow for simple, fast start-up and convenient diagnostics.

Valve equipment: Valves with or without pilot air supply

Multiple valve functions

- Single solenoid 5/2-way valves,
- 5/2-way double solenoid valves
- 5/3-way valves.

Valves with mechanical spring or pneumatic spring.

Instead of a valve, a relay with 2 floating contacts can be chosen.

The manual overrides of the valves are either pushing or detenting, and can be secured against unauthorised activation.

Multi-pin plug connection

Valve terminal VIMP-02-...

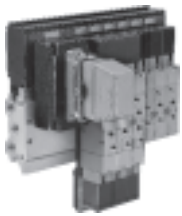

- 4 to 16 valve positions
- Connection via Harting plug 24 V DC
- 4 to 16 solenoid coils G $\frac{1}{8}$, G $\frac{1}{4}$

Can be connected to all control systems

Valve/sensor terminal IIMP-02-...

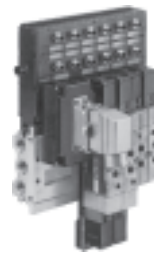

- 4 to 16 valve positions
- Equipped like a valve terminal, but:
 - Two additional sensor connections per valve position
 - Two additional electrical inputs 24 V and two outputs 24 V/0.5 A

Can be connected to all control systems

Fieldbus connection

Valve terminal VIFB-02-...



- 4 to 16 valve positions
- Connection to 24 V DC and fieldbus via special fieldbus plug
- 4 to 16 solenoid coils G $\frac{1}{8}$, G $\frac{1}{4}$

Can be connected to all major fieldbus systems

Valve/sensor terminal IIFB-02-...



- 4 to 14 valve positions
- Equipped like a valve terminal, but:
 - Two additional sensor connections per valve position
 - Two additional electrical inputs 24 V and two outputs 24 V/0.5 A

Can be connected to all major fieldbus systems

Programmable with integrated PLC

Valve/sensor terminal IIFB-02-...-SB-...



- 4 to 16 valve positions
- Connection 24 V DC
- 4 to 16 solenoid coils G $\frac{1}{8}$, G $\frac{1}{4}$
- Two additional sensor connections per valve position
- Two additional electrical inputs 24 V and two outputs 24 V/0.5 A

Autonomous on-site control with integrated Festo PLC and Festo fieldbus connection

- 1 - Type discontinued
Available up until 2010

Valve terminal type 02 VIMP/IIMP-02, Tiger 2000

FESTO

Features

Fieldbus variants

FESTO

DeviceNet

ABB

PROFIBUS

MOELLER 



 Allen-Bradley

Of the more than 20 different fieldbus systems (protocols) available in the market, some have emerged as the most important variants. Festo supports these by means of various fieldbus nodes (FBxx) on its valve terminals.

Fieldbus systems require a powerful, central PLC and a master interface adapted to that particular fieldbus. Fieldbus systems are generally used when several devices with many inputs/outputs, complex functions or high communication levels must be controlled. In this case, the advantages of simple cabling, easy diagnosis and maintenance outweigh the extra outlay for a fieldbus master interface and the necessary know-how.

Festo fieldbus:

A fieldbus developed by Festo with simple prompting, supported by the control systems in the FPC, SF and IPC series (Festo FB5).

A maximum of 98 bus stations can be connected to the Festo fieldbus. The bus can operate with 4 different baud rates. 31.25; 62.5; 187.75 and 375 kbps.

Interbus:

An open fieldbus standard, originally developed by Phoenix Contact and now in world-wide use. Important installation accessories such as bus plugs must be obtained from Phoenix or its partners (Festo FB6).

Profibus-DP:

An open fieldbus standard, originally developed by Siemens and in world-wide use. (Festo FB13 for 12 MBd).

DeviceNet:

An open fieldbus system based on CAN technology originally developed for the automotive sector. DeviceNet was originally sold by Rockwell (Allen-Bradley). Other CAN derivatives are available as well (Festo FB11).

Moeller SUCONET K:

A maximum of 98 bus stations can be connected to the SUCONET K fieldbus. The bus operates with a baud rate of 187.5 or 375 kbps, depending on the design, bus length, etc. The bus interface is based on RS 485 with a master/slave structure (Festo FB5).

ABB CS31:

The fieldbus from ABB connects a maximum of 63 fieldbus stations to the fieldbus master. The data is transferred at a constant baud rate of 187.5 kbps. The protocol is suitable for use in all areas of automation technology (Festo FB5).

Integrated Festo PLC

A powerful mini controller from Festo was integrated into the SF3 valve terminal node. This enables stand alone control of up to 34 inputs and 34 outputs on site with protection class IP65 – no need for a control cabinet. With the Festo fieldbus, additional I/Os and expanded functions can be installed and

controlled – this creates a programmable valve/sensor terminal.

The SF3 control block can be operated as required as a stand-alone, fieldbus master or fieldbus slave. 31 slaves with up to 1,048 inputs and outputs can be controlled via the fieldbus in the master operation mode.

The SF3 node can be used as an intelligent slave within the fieldbus in the slave operation mode. This enables stand alone on site pre-processing or a partial startup.





Start/stop signals to synchronise with other processes or controllers via the

additional electrical inputs and outputs.

The SF3 valve terminal can be programmed with FST 200 or a display and control device can be directly connected on-site via an RS 232 programming interface.

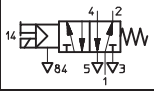
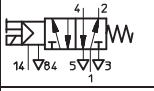
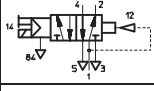
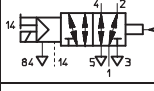
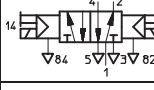
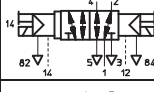
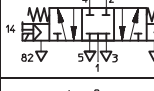
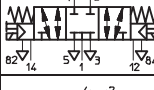
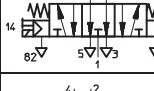
Valve terminal type 02 VIMP/IIMP-02, Tiger 2000

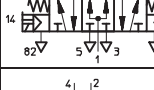
Key features – Pneumatics

Valve function				
Code	Circuit symbols	Connection		Description
		G1/8	G1/4	
M		■	■	5/2-way valve
V		■	■	5/2-way valve with pilot air supply
L		■	■	5/2-way valve with pneumatic spring
P		■	■	5/2-way solenoid valve with pneumatic spring return and pilot air supply
J		■	■	5/2-way double solenoid valve
K		■	■	5/2-way valve with pilot air supply
G		■	■	5/3-way valve Mid-position closed
O		■	■	5/3-way valve Mid-position closed with pilot air supply
E		■	■	5/3-way valve Mid-position exhausted
F		■	■	5/3-way valve Mid-position exhausted with pilot air supply
B		■	■	5/3-way valve Mid-position pressurised
C		■	■	5/3-way valve Mid-position pressurised with pilot air supply

-  - Note

For vacuum operation valves require a filter. This is to avoid that foreign matter is drawn into the valve (e.g. when using a suction cup).

-  - Type discontinued
Available up until 2010

FESTO

Valve terminal type 02 VIMP/IIMP-02, Tiger 2000

Key features – Mounting

Wall mounting, valve terminal

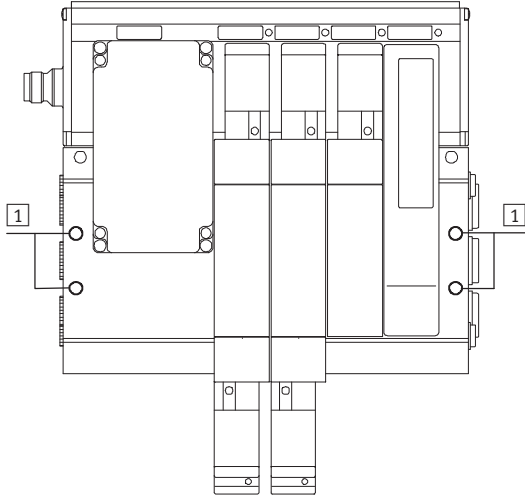

1 Mounting through holes for M6 hexagonal-head bolts

There are 4 through holes positioned on the right and left edges (1) of the connection block to facilitate attachment of the valve/sensor terminal.

- Make four through holes on the mounting surface.
- Attach the valve/sensor terminal to the mounting surface using M6x60 screws.

Valve terminal type 02 VIMP/IIMP-02, Tiger 2000

Key features – Display and operation

Operation and display components

Valve terminal

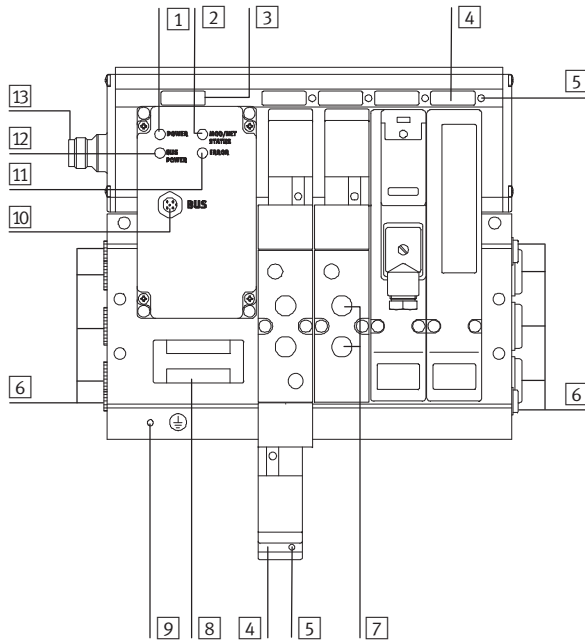

- 1 Green LED (POWER)
- 2 Bus-specific LED
- 3 Inscription field – Valve terminal
- 4 Inscription field – Valve position (per solenoid coil)
- 5 Yellow LED (per valve solenoid coil)
- 6 Common connections
- 7 Working line connections (per valve)
- 8 Rating plate
- 9 Earth terminal (M4 threads)
- 10 Fieldbus interface
- 11 Bus-specific LED
- 12 Bus-specific LED
- 13 Operating voltage connection

Valve/sensor terminal

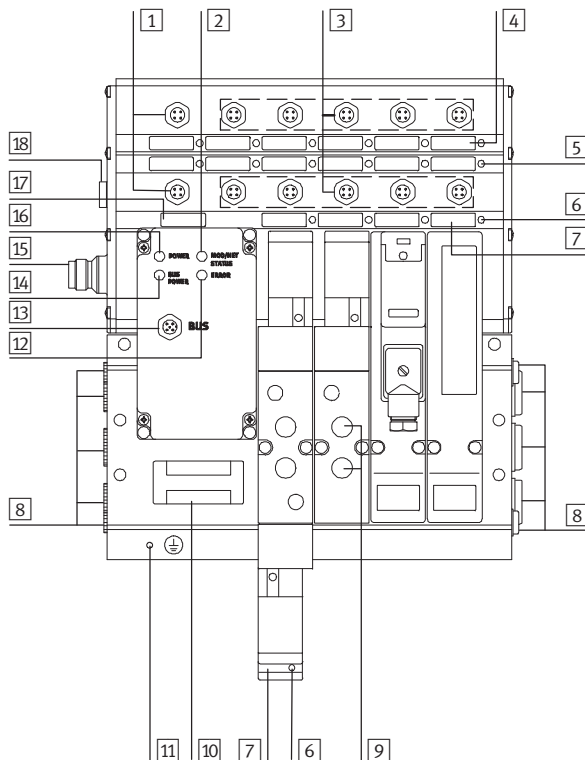

- 1 Connections for additional outputs
- 2 Bus-specific LED
- 3 Connections for inputs (e.g. sensors)
- 4 Inscription field for inputs and/or additional outputs (per connection)
- 5 Yellow or green LED (per input or additional output respectively)
- 6 Yellow LED (per solenoid coil)
- 7 Inscription field – Valve position (per solenoid coil)
- 8 Common connections
- 9 Working line connections (per valve)
- 10 Rating plate
- 11 Earth terminal (M4 threads)
- 12 Bus-specific LED
- 13 Fieldbus interface
- 14 Bus-specific LED
- 15 Operating voltage connection
- 16 Green LED (Power)
- 17 Inscription field – Valve/sensor terminal
- 18 Common fuse for inputs

- 1 - Type discontinued
Available up until 2010

FESTO

Valve terminal type 02 VIMP/IIMP-02, Tiger 2000

Key features – Display and operation

Manual override (MO)

Manual override with automatic return (non-locking)

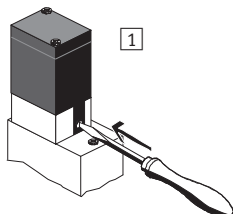

- 1 Press in the stem of the MO with a pin or a screwdriver.
→ Valve and/or process unit is activated.

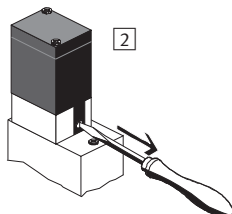

- 2 Remove the pin or screwdriver. The spring force pushes the stem of the MO back.
→ Valve and/or process unit returns to the initial position.

MO with detent

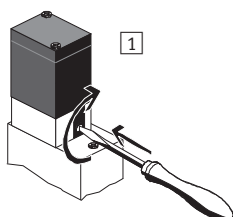

- 1 Press in the stem of the MO with the blade of a screwdriver until the valve switches and then turn to the right (clockwise).
→ Valve and/or process unit remains activated.

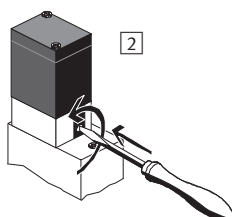

- 2 Press in the stem with the blade of a screwdriver and turn to the left (anti-clockwise). Remove the blade of the screwdriver. The spring force pushes the stem of the MO back.
→ Valve and/or process unit returns to the initial position.

Valve terminal type 02 VIMP/IIMP-02, Tiger 2000

Key features – Electrics

Pin allocation

Sensor inputs PNP (input and/or sensor connection)

Sockets (PNP) type 02

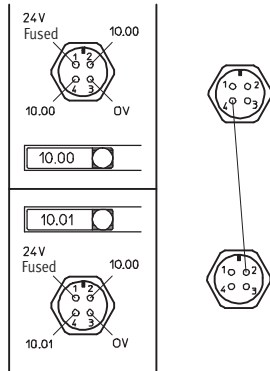

Two inputs (e.g. I0.00 and I0.01) are available on the lower plug, this

- reduces cable requirements (e.g. using DUO cable)
- Enables connection of changeover switch or selector switch

If you use the lower plug for two inputs, the upper socket must remain unused.

Additional outputs

Sockets (PNP)

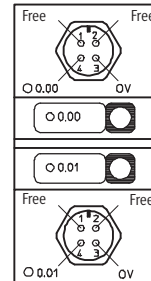

Power supply (only with fieldbus nodes and control blocks)



- Pin1: 24 V supply
Electronics + sensors
Tolerance: $\pm 25\%$
- Pin2: 24 V supply
Outputs
Tolerance: $\pm 10\%$
- Pin3: 0 V
- Pin4: Earth terminal

-  - Type discontinued
Available up until 2010

Valve terminal type 02 VIMP/IIMP-02, Tiger 2000

Key features – Electrics

FESTO

Multi-pin connector plug – Valve terminal

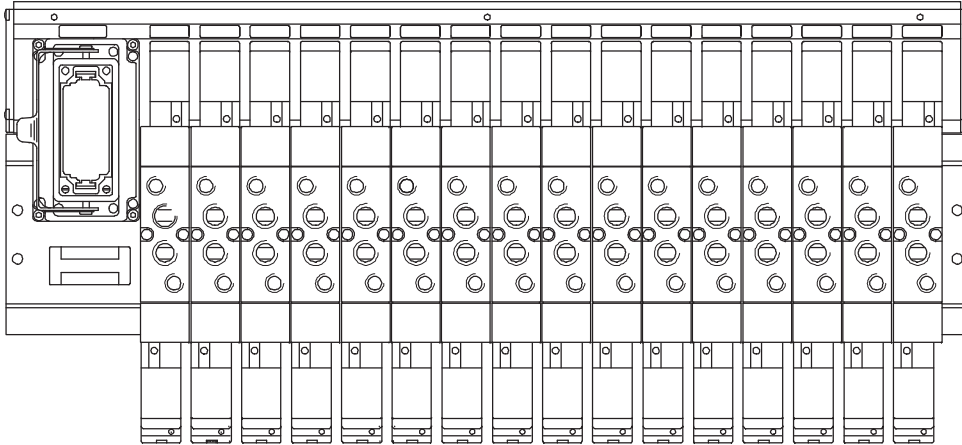

Pin allocation – Multi-pin connector plug - Valve terminal

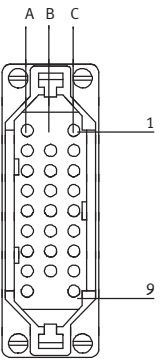
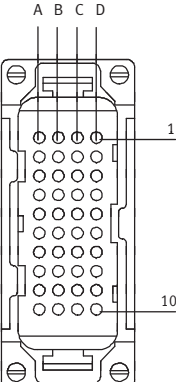
Connector view (top view)		A	B	C	D	Remarks
Multi-pin connector, 25-pin						
	1	0.00		1.00		Max. 12 valve positions 25-pin multi connector plug to DIN 43 652 Connecting cable 12 x 0.75 mm ² (4) 15 x 0.75 mm ² (6) 18 x 0.75 mm ² (8) 25 x 0.75 mm ² (10/12)
	2	0.01	0.09	1.01		
	3	0.02	0.10	1.02		
	4	0.03	0.11	1.03		
	5	0.04	0.12	1.04		
	6	0.05	0.13	1.05		
	7	0.06	0.14	1.06		
	8	0.07	0.15	1.07		
	9	0.08		1) ¹⁾		
	Output (solenoid valve position)					
Multi-pin connector, 40-pin						
	1	0.00	0.10	1.04	1.14	14 to 16 valve positions 40-pin multi connector plug to DIN 43 652 Connecting cable 41 x 0.75 mm ²
	2	0.01	0.11	1.05	1.15	
	3	0.02	0.12	1.06	–	
	4	0.03	0.13	1.07	–	
	5	0.04	0.14	1.08	–	
	6	0.05	0.15	1.09	–	
	7	0.06	1.00	1.10	–	
	8	0.07	1.01	1.11	–	
	9	0.08	1.02	1.12	1) ¹⁾	
	10	0.09	1.03	1.13	1) ¹⁾	
Output (solenoid valve position)						

1) Return line (output)

Valve terminal type 02 VIMP/IIMP-02, Tiger 2000

Key features – Electrics

Multi-pin connector plug, valve/sensor terminal

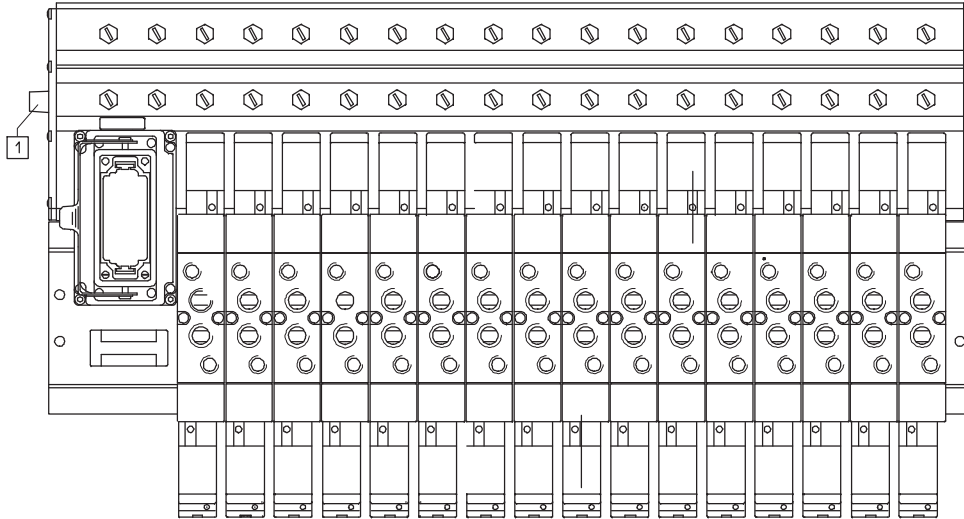

1 Protection T3A/250 V

Pin allocation – Multi-pin connector plug - Valve/sensor terminal

Connector view (top view)	A	B	C	D	Remarks	
Multi-pin connector, 25-pin						
	1	00.00		I0.06	Max. 4 valve positions 25-pin multi connector plug to DIN 43 652 Connecting cable 24 x 0.75 mm ²	
	2	00.01	00.09	I0.07		
	3	00.02	I0.10	I0.08		
	4	00.03	I0.11	I0.09		
	5	00.04	I0.12	-		
	6	00.05	I0.13	-		
	7	00.06	I0.14	24 V		
	8	00.07	I0.15	0 V		
	9	00.08		1)		
	Output (solenoid valve position)	Input				
Multi-pin connector, 40-pin						
	1	00.00	00.10	I0.00	I0.10	6 to 8 valve positions 40 pin multi connector plug Connecting cable 41 x 0.75 mm ²
	2	00.01	00.11	I0.01	I0.11	
	3	00.02	00.12	I0.02	I0.12	
	4	00.03	00.13	I0.03	I0.13	
	5	00.04	00.14	I0.04	I0.14	
	6	00.05	00.15	I0.05	I0.15	
	7	00.06	01.00	I0.06	I1.00	
	8	00.07	01.01	I0.07	I1.01	
	9	00.08	-	I0.08	24 V	
	10	00.09	COMMON	I0.09	0 V	
Output (solenoid valve position)	Input					

1) Return line (output)
24 V, 0 V supply (input, protection T 3.15 A)

-  - Type discontinued
Available up until 2010

Valve terminal type 02 VIMP/IIMP-02, Tiger 2000

FESTO

Key features – Electrics

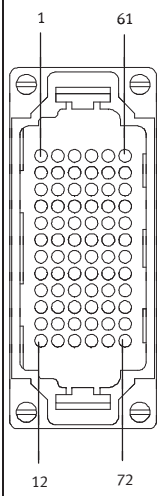
Pin allocation – Multi-pin connector plug - Valve/sensor terminal								
Connector view (top view)		1-12	13-24	25-36	37-48	49-60	61-72	Remarks
Multi-pin connector, 72-pin								
	1	00.00	00.12	01.08	10.00	10.12	11.08	10 to 16 valve positions 72 pin multi connector plug Connecting cable 50 x 0.75 mm ² (10) 65 x 0.75 mm ² (12/14) 80 x 0.75 mm ² (16)
	2	00.01	00.13	01.09	10.01	10.13	11.09	
	3	00.02	00.14	01.10	10.02	10.14	11.10	
	4	00.03	00.15	01.11	10.03	10.15	11.11	
	5	00.04	01.00	01.12	10.04	11.00	11.12	
	6	00.05	01.01	01.13	10.05	11.01	11.13	
	7	00.06	01.02	01.14	10.06	11.02	11.14	
	8	00.07	01.03	01.15	10.07	11.013.0	11.15	
	9	00.08	01.04	02.00	10.08	11.04	12.00	
	10	00.09	01.05	02.01	10.09	11.05	12.01	
	11	00.10	01.06	¹⁾	10.10	11.06	24 V	
	12	00.11	01.07	¹⁾	10.11	11.07	0 V	
Output (solenoid valve position)				Input				

- 1) Return line (output)
24 V, 0 V supply (input, protection T 3.15 A)

Valve terminal type 02 VIMP/IIMP-02, Tiger 2000

Technical data

-  - Flow rate up to
 G $\frac{1}{8}$: 750 l/min
 1,000 l/min
 G $\frac{1}{4}$: 1,300 l/min
 1,600 l/min

-  - Valve width
 G $\frac{1}{8}$ 26 mm
 G $\frac{1}{4}$ 32 mm

-  - Voltage
 24 V DC



General technical data			
Valve terminal		Connection size G $\frac{1}{8}$	Connection size G $\frac{1}{4}$
Design		Poppet valve (5/2-way valves MVH and MVH-S), all others piston spool valves	
Width	[mm]	26	32
Lubrication		<ul style="list-style-type: none"> • Poppet valve: Lubricated for life, PWIS free (free of paint wetting impairment substances) • Piston spool valve: Lubricated for life, PWIS critical (critical for paint wetting impairment substances) 	
Type of mounting		Through-holes on manifold	
Fitting position		Any	
Manual override		Non-detenting, detenting	
Pneumatic connections			
Work air connection	1	G $\frac{3}{8}$	G $\frac{1}{2}$
Exhaust connection	3/5	G $\frac{3}{8}$	G $\frac{1}{2}$
Working lines	2/4	G $\frac{1}{8}$	G $\frac{1}{4}$
Pilot air supply connection	12/14	G $\frac{1}{8}$	G $\frac{1}{8}$
Pilot exhaust air connection	82/84	G $\frac{1}{8}$	G $\frac{1}{8}$

Nominal size [mm]								
Valves	MVH	MVH-S	MVH-L	MVH-L-S	JMVH	JMVH-S	MVH-5/3	MVH-5/3-S
Connection size G $\frac{1}{8}$	5		8					
Connection size G $\frac{1}{4}$	7		10					

Operating pressure [bar]								
Valves	MVH	MVH-S	MVH-L	MVH-L-S	JMVH	JMVH-S	MVH-5/3	MVH-5/3-S
	2 ... 10	0 ... 10	3 ... 10	-0.9 ... +10	2 ... 10	-0.9 ... +10	3 ... 10	-0.9 ... +10

Pilot pressure [bar]								
Valves	MVH	MVH-S	MVH-L	MVH-L-S	JMVH	JMVH-S	MVH-5/3	MVH-5/3-S
Connection size G $\frac{1}{8}$	-	2 ... 10	-	3 ... 10	-	2 ... 10	-	3 ... 10
Connection size G $\frac{1}{4}$	-	1.5 ... 10	-	3 ... 10	-	2 ... 10	-	3 ... 10

- 1 - Type discontinued
Available up until 2010

FESTO

Valve terminal type 02 VIMP/IIMP-02, Tiger 2000

Technical data

Valve response times [ms]									
Valves		MVH	MVH-S	MVH-L	MVH-L-S	JMVH	JMVH-S	MVH-5/3	MVH-5/3-S
Response times (G ^{1/8})	On	20	20	31	31	-	-	30	30
	Off	36	36	18	18	-	-	26	26
	Change-over	-	-	-	-	18	18	-	-
Response times (G ^{1/4})	On	15	15	28	28	-	-	32	32
	Off	36	36	37	37	-	-	28	28
	Change-over	-	-	-	-	16	16	-	-

Operating and environmental conditions									
Valves		MVH	MVH-S	MVH-L	MVH-L-S	JMVH	JMVH-S	MVH-5/3	MVH-5/3-S
Operating medium		filtered compressed air, lubricated or unlubricated							
Grade of filtration	[µm]	40							
Ambient temperature	[°C]	-5 ... +50							

Electrical data									
Valves		MVH	MVH-S	MVH-L	MVH-L-S	JMVH	JMVH-S	MVH-5/3	MVH-5/3-S
Electromagnetic compatibility of the valve terminal		Interference emission tested to EN 61 000-6-4, "Interference emission in industry" Interference immunity tested to EN 61 000-6-2, "Interference immunity in industry"							
Protection against electric shock (protection against direct and indirect contact to EN 60204-1/IEC 204)		Through PELV power supply unit							
Operating voltage	[V]	24 DC (±10%)							
Residual ripple	[V _{SS}]	4							
Electrical power consumption per valve solenoid	[W]	2.9							
Duty cycle		100%							
Protection class to EN 60 529		IP65 (when fitted)							
Sensor inputs and auxiliary inputs		0 ... 30 V DC, positive logic (PNP), ON: 12.5 V, OFF: 7 V Delay time: typ. 5 ms, current consumption typ. 9 mA							
Additional outputs		24 V DC, 0.5 A, positive logic (PNP) Short circuit proof, tripping current max. 1 A, response time max. 1 ms							
Vibration resistance		Tested to DIN/IEC 68/EN 60 068, Parts 2-6 0.35 mm at 10 ... 58 Hz, 5 g at 60 ... 150 Hz							
Resistance to shocks		Tested to DIN/IEC 68/EN 60 068, Parts 2-27 +/- 30 g at 11 ms, 15 cycles							
Endurance resistance to shock		Tested to DIN/IEC 68/EN 60 068, Parts 2-29 +/- 15 g at 6 ms, 1000 cycles							

 Type discontinued
Available up until 2010

FESTO

Valve terminal type 02 VIMP/IIMP-02, Tiger 2000

Technical data

Electrical data, relay plate		
Relay plate IRP1-02-.../IRP2-02-...	NO contact	Relay is controlled like a valve
• Max. switching voltage	250 V AC/125 V AC	
• Max. switching/carrier current	2 A	
• Min. permissible load	5 V DC, 10 mA	
• Permissible electrical load	Resistive load ($\cos\varphi = 1$, L/R = 0 ms)	Inductive load ($\cos\varphi = 0.4$, L/R = 7 ms)
• Nominal load	250 V AC, 2 A 30 V DC, 2 A	250 V AC, 1 A 30 V DC, 1 A
• Max. switching capacity	500 VA, 60 W	250 VA, 30 W

Materials								
Valves	MVH	MVH-S	MVH-L	MVH-L-S	JMVH	JMVH-S	MVH-5/3	MVH-5/3-S
Housing, cover	Die-cast aluminium							
Seals	PU, nitrile rubber (NBR)							

Nominal flow rate [l/min]								
Valves	MVH	MVH-S	MVH-L	MVH-L-S	JMVH	JMVH-S	MVH-5/3	MVH-5/3-S
Connection size G $\frac{1}{8}$	750		1000					
Connection size G $\frac{1}{4}$	1300		1600					

-  - Type discontinued
Available up until 2010

Valve terminal type 02 VIMP/IIMP-02, Tiger 2000

Technical data

FESTO

Dimensions

without inputs

Download CAD data → www.festo.com

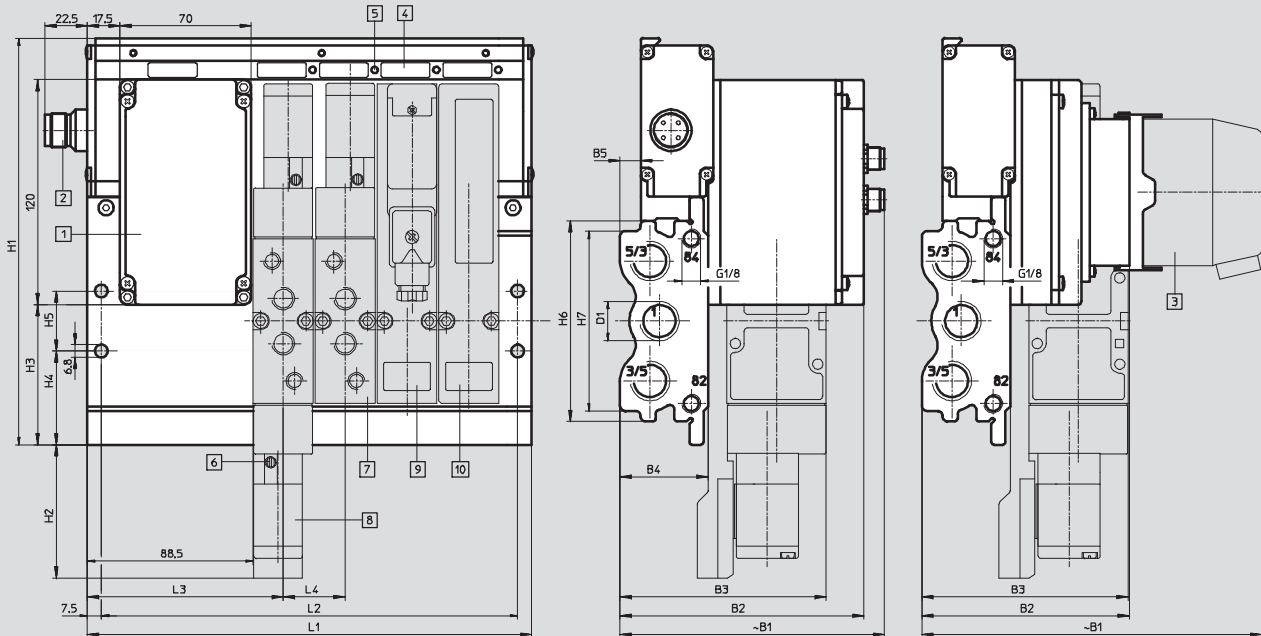

- | | | | |
|---|--|----------------------------------|--|
| 1 Fieldbus nodes, control block or multi-connection nodes | 3 Multi-pin connector plug socket for VIMP | 6 Manual override, non-detenting | 8 Double solenoid valve or 5/3-way valve |
| 2 Power supply for VIFB, VISB | 4 Inscription field | 7 Solenoid valve | 9 Relay plate |
| | 5 LED display, yellow | | 10 Blanking plate |

- 1 - Type discontinued
Available up until 2010

FESTO

Valve terminal type 02 VIMP/IIMP-02, Tiger 2000

Technical data

Type	B1~	B2	B3	B4	B5	D1	H1	H2	H3	H4	H5	H6	H7	L1	L2	L3	L4	L5
VIFB-02-1/8-4	140	128.8	102.5	45.5	8.4	G3/8	205	70.5	62.6	46.2	27.5	95	75	213	198	101.5	27	5
VIMP-02-1/8-4	180	109.2												267	252			
VIFB-02-1/8-6	140	128.5												321	306			
VIMP-02-1/8-6	180	109.2												375	360			
VIFB-02-1/8-8	140	128.5												429	414			
VIMP-02-1/8-8	180	109.2												483	468			
VIFB-02-1/8-10	140	128.5												537	522			
VIMP-02-1/8-10	180	109.2																
VIFB-02-1/8-12	140	128.5																
VIMP-02-1/8-12	180	109.2																
VIFB-02-1/8-14	140	128.5																
VIMP-02-1/8-14	180	109.2																
VIFB-02-1/8-16	140	128.5																
VIMP-02-1/8-16	180	109.2																
VIFB-02-1/4-4	141	130	110	47	11.1	G1/2	217	71	75	50	32	107	96	237	222	104.5	33	6
VIMP-02-1/4-4	182	110.7												303	288			
VIFB-02-1/4-6	141	130												369	354			
VIMP-02-1/4-6	182	110.7												435	420			
VIFB-02-1/4-8	141	130												501	486			
VIMP-02-1/4-8	182	110.7												567	552			
VIFB-02-1/4-10	141	130												633	618			
VIMP-02-1/4-10	182	110.7																
VIFB-02-1/4-12	141	130																
VIMP-02-1/4-12	182	110.7																
VIFB-02-1/4-14	141	130																
VIMP-02-1/4-14	182	110.7																
VIFB-02-1/4-16	141	130																
VIMP-02-1/4-16	182	110.7																

-  - Type discontinued
Available up until 2010

Valve terminal type 02 VIMP/IIMP-02, Tiger 2000

Technical data

FESTO

Dimensions

Download CAD data → www.festo.com

With inputs

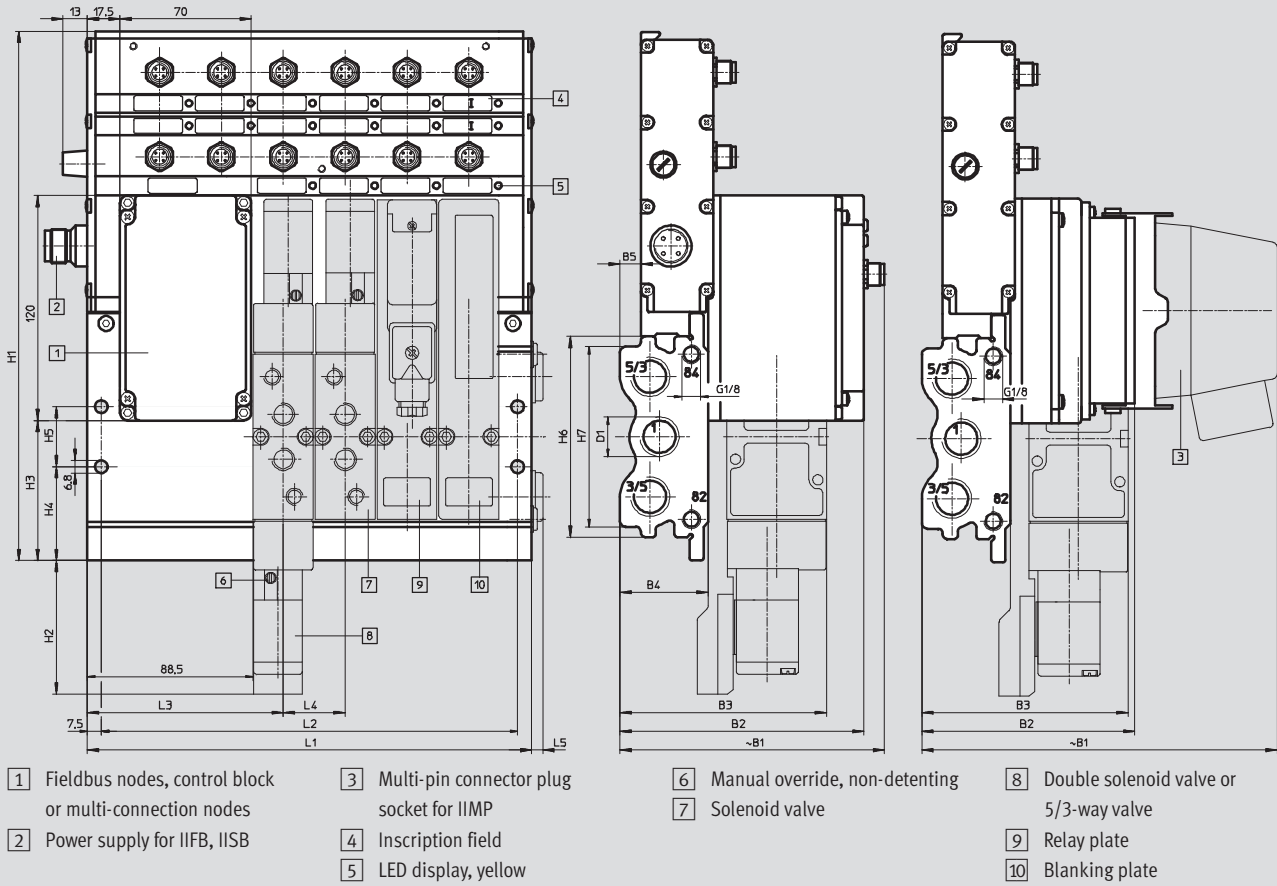

- 2 - Type discontinued
Available up until 2010

FESTO

Valve terminal type 02 VIMP/IIMP-02, Tiger 2000

Technical data

Type	B1~	B2	B3	B4	B5	D1	H1	H2	H3	H4	H5	H6	H7	L1	L2	L3	L4	L5
IIFB-02-1/8-4	140	128.8	102.5	45.5	8.4	G3/8	270.5	70.5	62.6	46.2	27.5	95	75	213	198	101.5	27	5
IIMP-02-1/8-4	188	112												267	252			
IIFB-02-1/8-6	140	128.5												321	306			
IIMP-02-1/8-6	188	112												375	360			
IIFB-02-1/8-8	140	128.5												429	414			
IIMP-02-1/8-8	188	112												483	468			
IIFB-02-1/8-10	140	128.5												537	522			
IIMP-02-1/8-10	188	112																
IIFB-02-1/8-12	140	128.5																
IIMP-02-1/8-12	188	112																
IIFB-02-1/8-14	140	128.5																
IIMP-02-1/8-14	188	112																
IIFB-02-1/8-16	140	128.5																
IIMP-02-1/8-16	188	112																
IIFB-02-1/4-4	141	130	110	47	11.1	G1/2	282.5	71	75	50	32	107	96	237	222	104.5	33	6
IIMP-02-1/4-4	190	113.5												303	288			
IIFB-02-1/4-6	141	130												369	354			
IIMP-02-1/4-6	190	113.5												435	420			
IIFB-02-1/4-8	141	130												501	486			
IIMP-02-1/4-8	190	113.5												567	552			
IIFB-02-1/4-10	141	130												633	618			
IIMP-02-1/4-10	190	113.5																
IIFB-02-1/4-12	141	130																
IIMP-02-1/4-12	190	113.5																
IIFB-02-1/4-14	141	130																
IIMP-02-1/4-14	190	113.5																
IIFB-02-1/4-16 ¹⁾	141	130																
IIMP-02-1/4-16	190	113.5																

1) 16 valve positions are not possible for the fieldbus connection, but are possible for control block SB-.....

Valve terminal type 02 VIMP/IIMP-02, Tiger 2000

Ordering information

Ordering system information

Basic entry

You can order a valve terminal type 02 via an order code (also called ident. code).

First, choose between a basic valve terminal (without sensor inputs) or a valve/sensor terminal with sensor inputs (VI or II).

Then select the required connection types on the valve terminal nodes (MP, FB or SB).

Select the required valve connection size (G $\frac{1}{8}$ or G $\frac{1}{4}$)

Then determine how many valve positions you need.

- A valve terminal type 02 consists of at least 4 valve positions and can be expanded two by two. Vacant positions may also be included to allow for expansion at a later point in time, which can be closed off with inexpensive blanking plates.

Select the nodes you want to equip your valve terminal with. There are various types available, in particular for fieldbuses and control blocks.

With this data, the order code for the example expands as follows:

- VIMP-02- $\frac{1}{8}$ -6-MP1-...
- VIFB-02- $\frac{1}{4}$ -10-FB6-...
- IIFB-02- $\frac{1}{4}$ -16-SF3-...
- IISB-02- $\frac{1}{4}$ -...

Decide which valve (relay/blanking plate) should be assembled on which valve position.

Note that each valve terminal can be fitted with up to 16 valve positions, however a valve/sensor terminal with sensor inputs combined with a fieldbus connection only has 14 valve positions.

Enter the code letters accordingly.

This information provides you with the precise basic data for the order code of the valve terminal, i. e.:

- VIMP-02- $\frac{1}{8}$ -...
- VIFB-02- $\frac{1}{4}$ -...
- IIFB-02- $\frac{1}{4}$ -...
- IISB-02- $\frac{1}{4}$ -...

Accessories

These code letters are followed by entries for any required accessories such as

- Separating plugs for two separate pressure zones
- Plugs for sensors
- Special DUO cable for two sensors on one plug
- Sockets for operating voltage connection, fieldbus connection, control block programming interface or auxiliary outputs.

Please ensure: That you order the correct plug accessories for the fieldbus connections and for the control blocks.

The following applies to accessories: Several identical components can be grouped and ordered by using a prefixed number, i.e. "4S" instead of "SSSS".

Each valve terminal is generally supplied with a comprehensive, user-friendly manual.

If you already have the relevant manuals, you can specify this in the order code (add code "B"). It is also possible to order additionally required manuals, even in other languages if required. Other languages on request.

Individual parts can be ordered via their part numbers for retrofitting and expansion independent of the order code. Use the depicted overview list in addition to the explanations for the ident. code order.

Complete order examples:

VIMP-02- $\frac{1}{8}$ -6-MP1-JJMMMA-C

VIFB-02- $\frac{1}{4}$ -FB6-10-JJMMMAQQQ-CMB

IIFB-02- $\frac{1}{4}$ -16-SF3-JJJMMMMMMQQQ-M4S16J

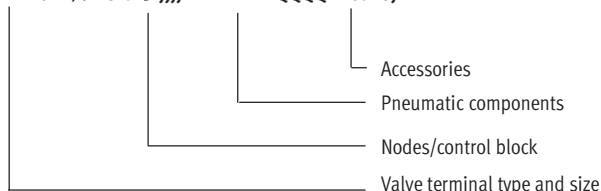



 Type discontinued
Available up until 2010

FESTO

Valve terminal type 02 VIMP/IIMP, Tiger 2000

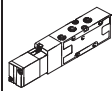
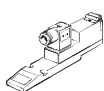
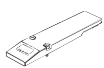
Ordering data – Accessories









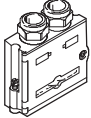

Ordering data					
	Code	Description	Connection	Type	Part No.
Valves					
	M	5/2-way valve	G $\frac{1}{8}$	MVH-5- $\frac{1}{8}$ -B-VI-X	164 564
			G $\frac{1}{4}$	MVH-5- $\frac{1}{4}$ -B-VI-X	164 566
	V	5/2-way valve with pilot air supply	G $\frac{1}{8}$	MVH-5- $\frac{1}{8}$ -S-B-VI	116 001
			G $\frac{1}{4}$	MVH-5- $\frac{1}{4}$ -S-B-VI	116 003
	L	5/2-way valve with pneumatic spring	G $\frac{1}{8}$	MVH-5- $\frac{1}{8}$ -L-B-VI	117 424
			G $\frac{1}{4}$	MVH-5- $\frac{1}{4}$ -L-B-VI	117 428
	P	5/2-way valve with pneumatic spring and pilot air supply	G $\frac{1}{8}$	MVH-5- $\frac{1}{8}$ -L-S-B-VI	117 426
			G $\frac{1}{4}$	MVH-5- $\frac{1}{4}$ -L-S-B-VI	117 430
	J	5/2-way double solenoid valve	G $\frac{1}{8}$	JMVH-5- $\frac{1}{8}$ -B-VI-X	164 565
			G $\frac{1}{4}$	JMVH-5- $\frac{1}{4}$ -B-VI-X	164 567
	K	5/2-way double valve with pilot air supply	G $\frac{1}{8}$	JMVH-5- $\frac{1}{8}$ -S-B-VI	116 005
			G $\frac{1}{4}$	JMVH-5- $\frac{1}{4}$ -S-B-VI	116 007
	G	5/3-way valve Mid-position closed	G $\frac{1}{8}$	MVH-5/3G- $\frac{1}{8}$ -B-VI-X	164 568
			G $\frac{1}{4}$	MVH-5/3G- $\frac{1}{4}$ -B-VI-X	164 571
	O	5/3-way valve Mid-position closed with pilot air supply	G $\frac{1}{8}$	MVH-5/3G- $\frac{1}{8}$ -S-B-VI	118 800
			G $\frac{1}{4}$	MVH-5/3G- $\frac{1}{4}$ -S-B-VI	118 806
	E	5/3-way valve Mid-position exhausted	G $\frac{1}{8}$	MVH-5/3E- $\frac{1}{8}$ -B-VI-X	164 570
			G $\frac{1}{4}$	MVH-5/3E- $\frac{1}{4}$ -B-VI-X	164 573
	F	5/3-way valve Mid-position exhausted with pilot air supply	G $\frac{1}{8}$	MVH-5/3E- $\frac{1}{8}$ -S-B-VI	118 804
			G $\frac{1}{4}$	MVH-5/3E- $\frac{1}{4}$ -S-B-VI	118 810
B	5/3-way valve Mid-position pressurised	G $\frac{1}{8}$	MVH-5/3B- $\frac{1}{8}$ -B-VI-X	164 569	
		G $\frac{1}{4}$	MVH-5/3B- $\frac{1}{4}$ -B-VI-X	164 572	
C	5/3-way valve Mid-position pressurised with pilot air supply	G $\frac{1}{8}$	MVH-5/3B- $\frac{1}{8}$ -S-B-VI	118 802	
		G $\frac{1}{4}$	MVH-5/3B- $\frac{1}{4}$ -S-B-VI	118 808	
Accessories - General					
	R	Relay plate, x1	G $\frac{1}{8}$	IRP1-02- $\frac{1}{8}$	158 476
			G $\frac{1}{4}$	IRP1-02- $\frac{1}{4}$	158 477
	Q	Relay plate, x2	G $\frac{1}{8}$	IRP2-02- $\frac{1}{8}$	152 838
			G $\frac{1}{4}$	IRP2-02- $\frac{1}{4}$	152 839
	A	Blanking plate	G $\frac{1}{8}$	IAP-02- $\frac{1}{8}$	18 067
			G $\frac{1}{4}$	IAP-02- $\frac{1}{4}$	18 068
		Inscription label holder for I/O modules, type 02		IBT-02-E/A	158 968
		Inscription labels (pack of 20)		IBS-9x20	18 182
Pneumatic accessories					
	D	Sealing plug	G $\frac{1}{8}$	PRSV- $\frac{1}{8}$	160 997
			G $\frac{1}{4}$	PRSV- $\frac{1}{4}$	160 996

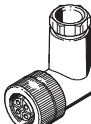
- 1 - Type discontinued
Available up until 2010

Valve terminal type 02 VIMP/IIMP, Tiger 2000

FESTO

Ordering data – Accessories

Ordering data					
	Code	Description	Connection	Type	Part No.
Fieldbus connection					
	V	Plug, sub-D connection	9-pin	FBS-Sub-9-GS-DP-B	532 216
		Bus connection, M12 adapter plug, Reversekey Profibus DP	2x5-pin, M12	FBA-2-M12-5POL-RK	533 118
	Z	Socket, fieldbus, straight, Pg7	4-pin, M12	FBSD-GD-7	18 497
	T	Socket, fieldbus, straight, Pg9	4-pin, M12	FBSD-GD-9	18 495
	U	Socket, fieldbus, straight, Pg13.5	4-pin, M12	FBSD-GD-13,5	18 496
	E	Socket, fieldbus, angled, Pg7	4-pin, M12	FBSD-WD-7	18 524
	F	Socket, fieldbus, angled, Pg9	4-pin, M12	FBSD-WD-9	18 525
		T adapter	4-pin, M12	FB-TA	18 498
			4-pin, M12	FB-TA-1	18 499
			5-pin, M12, DeviceNet	FB-TA-M12-5POL	171 175
		Plug pin adapter	4-pin, M12	SIE-GA	18780
Power supply					
	N	Power supply socket, straight, for 1.5 mm ² , Pg9	4-pin, M18	NTSD-GD-9	18 493
	M	Power supply socket, straight, for 2.5 mm ² , Pg13.5	4-pin, M18	NTSD-GD-13,5	18 526
	I	Power supply socket, angled, for 1.5 mm ² , Pg9	4-pin, M18	NTSD-WD-9	18 527
		Power supply socket, angled, for 2.5 mm ² , Pg11	4-pin, M18	NTSD-WD-11	533 119
Sensor connection					
	S	Plug, for inputs/outputs, straight, Pg7	4-pin, M12	SEA-GS-7	18 666
	J	DUO cable, 2xstraight socket	4-pin, M12, 2xM8	KM12-DUO-M8-GDGD	18 685
	K	DUO cable, straight/angled sockets	4-pin, M12, 2xM8	KM12-DUO-M8-GDWD	18 688
	L	DUO cable, 2xangled socket	4-pin, M12, 2xM8	KM12-DUO-M8-WDWD	18 687
	P	Connection cable, straight plug / straight socket, 2.5 m	4-pin, M12	KM12-M12-GSGD-2,5	18 684
	Q	Connection cable, straight plug / straight socket, 5.0 m	4-pin, M12	KM12-M12-GSGD-5	18 686

- 1 - Type discontinued
Available up until 2010

FESTO

Valve terminal type 02 VIMP/IIMP, Tiger 2000

Ordering data – Accessories

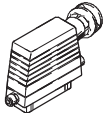
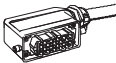
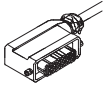
Ordering data					
	Code	Description	Connection	Type	Part No.
Cables and plugs					
	Y	Multi-pin plug socket (contacts 1.5 mm ²)	25-pin	IMP1-SD-25	18 317
			40-pin	IMP1-SD-40	18 318
			72-pin	IMP1-SD-72	18 319
	W	Multi-pin plug socket (contacts 0.75 mm ²)	25-pin	IMP1-SD-25-0,75	18 321
			40-pin	IMP1-SD-40-0,75	18 322
			72-pin	IMP1-SD-72-0,75	18 323
		Prefabricated cable with plug socket, 5 m	4...6 valves	KMP1-02-VI-6-5	175 585
			8...12 valves	KMP1-02-VI-12-5	175 587
			14...16 valves	KMP1-02-VI-16-5	175 589
		Prefabricated cable with plug socket, 10 m	4...6 valves	KMP1-02-VI-6-10	175 586
			8...12 valves	KMP1-02-VI-12-10	175 588
			14...16 valves	KMP1-02-VI-16-10	175 590
		Prefabricated cable with plug socket, for valve/sensor terminal, 5 m	4 valves/inputs	KMP1-02-II-4-5	175 654
			8 valves/inputs	KMP1-02-II-8-5	175 656
			10 valves/inputs	KMP1-02-II-10-5	175 658
			14 valves/inputs	KMP1-02-II-14-5	175 660
			16 valves/inputs	KMP1-02-II-16-5	175 662
		Prefabricated cable with plug socket, for valve/sensor terminal, 10 m	4 valves/inputs	KMP1-02-II-4-10	175 655
			8 valves/inputs	KMP1-02-II-8-10	175 657
			10 valves/inputs	KMP1-02-II-10-10	175 659
			14 valves/inputs	KMP1-02-II-14-10	175 661
			16 valves/inputs	KMP1-02-II-16-10	175 663

- 1 - Type discontinued
Available up until 2010

FESTO

Valve terminal type 02 VIMP/IIMP, Tiger 2000

Ordering data – Accessories

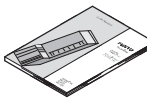
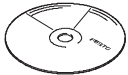
Ordering data						
	Description	Valve terminal	Language	Type	Part No.	
User documentation						
	User documentation for type 02 valve terminals	FB5	German	P.BE-VIFB5-02-DE	18 417	
			English	P.BE-VIFB5-02-EN	18 483	
		FB6	German	P.BE-VIFB6-02-DE	18 418	
			English	P.BE-VIFB6-02-EN	18 484	
		FB8	German	P.BE-VIFB8-02-DE	151 762	
			English	P.BE-VIFB8-02-EN	151 763	
		FB11	German	P.BE-VIFB11-02-DE	164 585	
			English	P.BE-VIFB11-02-EN	164 590	
		FB13	German	P.BE-VIFB13-02-DE	164 587	
			English	P.BE-VIFB13-02-EN	164 592	
		SF3	German	P.BE-VISF3-02-DE	165 480	
			English	P.BE-VISF3-02-EN	165 485	
		User documentation for programmable valve terminals	Programming software SF3	German	P.BE-FST200-AWL/KOP-DE	165 484
				English	P.BE-FST200-AWL/KOP-EN	165 489
Software						
	CD-ROM	Utilities		P.CD-VI-UTILITIES-2	533 500	