

Mini slide EGSC-BS

FESTO



Characteristics

At a glance

[Link ↗ egsc-bs](#)

- Four very compact sizes for precise positioning at up to 600 mm/s to max. 200 mm
- Yoke slide with high load-bearing recirculating ball bearing guide
- Very compact design thanks to integrated coupling
- Very high-quality ball screw with low internal friction
- Rigid, high load-bearing and precise linear guide for absorbing lateral forces and for increased protection against rotation
- Ring magnet for position detection. For simple and cost-effective position sensing
- Suitable for the production of Li-ion batteries

Sealing air connection

- Air is exchanged between the interior of the cylinder and the environment via a sealing air connection. This prevents negative pressure or excess pressure from developing in the cylinder interior.
- Application of slight negative pressure prevents the emission of particles
- Application of slight overpressure prevents the immission of particles

Engineering tools

[Link ↗ engineering tools](#)

Save time with engineering tools: Smart engineering for the optimal solution. Our goal is to increase your productivity. Our engineering tools play an integral part in achieving this goal. They help you size your system correctly, tap into unimagined productivity reserves and generate additional productivity along the entire value chain. In every phase of your project, from the initial contact to the modernisation of your machine, you will come across a number of different tools that will be of use to you.

Electric Motion Sizing

- Create the optimum drive package quickly and reliably. Electric Motion Sizing calculates suitable combinations of electric axis, electric motor and servo drive using just a few application details. It provides all the relevant data including the bill of materials and documentation for your selected combination. This avoids design errors and results in significantly improved energy efficiency for the system. A smooth connection to the Festo Automation Suite also makes commissioning easier for you.

Diagrams

[Link ↗ egsc-bs](#)

The diagrams shown in this document are also available online. These can be used to display precise values.

Drive system

[BS] Ball screw drive

- For applications that require precision
- High reliability and long service life
- For large loads

Guide

- Very sturdy and precise guiding principle for transmitting the drive force and moving additional loads
- The guide can easily absorb high torques and forces

Spindle pitch

The spindle pitch describes the distance travelled by the spindle nut per revolution of the spindle in millimetres.

Characteristics

Overview

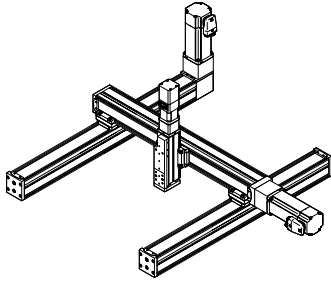

- From the individual axis to the handling system, such as a cantilever system, planar surface gantry or three-dimensional gantry
- The toothed belt and spindle axes ELGC and mini slides EGSC form a scalable modular system for compact automation systems
- The common platform architecture provides an integrated range with matching interfaces. A large number of systems can be implemented completely without adapter plates
- High-performance drive and guide elements ensure a long service life as well as excellent load-bearing capacity and reliability
- The uniform and universal range of accessories reduces warehousing and design costs

Type code

001	Series
EGSC	Mini slide

002	Drive system
BS	Ball screw drive

003	Guide
KF	Recirculating ball bearing guide

004	Size
25	25
32	32
45	45
60	60

005	Stroke [mm]
25	25
50	50
75	75
100	100
125	125
150	150
200	200

006	Spindle pitch
2P	2 mm
3P	3 mm
5P	5 mm
6P	6 mm
8P	8 mm
10P	10 mm
12P	12 mm

Datasheet

General technical data									
Size	25		32		45		60		
Spindle pitch	2	6	3	8	3	10	5	12	
Design	Electric mini slide, With ball screw drive								
Guide	Recirculating ball bearing guide								
Mounting position	optional								
Working stroke	25 mm; 50 mm; 75 mm		25 mm; 50 mm; 75 mm; 100 mm		25 mm; 50 mm; 75 mm; 100 mm; 125 mm; 150 mm		50 mm; 75 mm; 100 mm; 125 mm; 150 mm; 200 mm		
Reference value effective load, horizontal	2 kg		6 kg		12 kg		25 kg		
Reference value effective load, vertical	2 kg		6 kg		12 kg		25 kg		
Max. feed force Fx	20 N		60 N		120 N		250 N		
Idle torque at vmin	0.005 Nm	0.015 Nm	0.013 Nm	0.025 Nm	0.015 Nm	0.03 Nm	0.032 Nm	0.04 Nm	
Idle torque at vmax	0.015 Nm	0.029 Nm	0.044 Nm	0.042 Nm	0.059 Nm	0.1 Nm	0.125 Nm	0.306 Nm	
Max. radial force at drive shaft	30 N		75 N		180 N		230 N		
Max. rotational speed	4,000 rpm		3,750 rpm		3,600 rpm		3,000 rpm		
Max. acceleration	5 m/s ²	15 m/s ²	5 m/s ²	15 m/s ²	5 m/s ²	15 m/s ²	5 m/s ²	15 m/s ²	
Repetition accuracy	±0.015 mm								
Reversing backlash theoretical	150 µm								
Position detection	Via proximity switch								

Operating and environmental conditions	
Ambient temperature ¹⁾	0 ... 50°C
Degree of protection	IP40
Duty cycle	100%
Cleanroom class	Class 9 according to ISO 14644-1
Maintenance interval	Life-time lubrication

1) Note operating range of the proximity switches

Weight								
Size	25		32		45		60	
Basic weight for 0 mm stroke ¹⁾	176 g		331 g		608 g		1,555 g	
Additional weight per 10 mm stroke	19 g		30 g		63 g		95 g	
Moving mass for 0 mm stroke	83 g		149 g		212 g		675 g	
Additional moving mass per 10 mm stroke	9 g		12 g		30 g		40 g	

1) Incl. slide

Spindle								
Size	25		32		45		60	
Spindle diameter	6 mm		8 mm		10 mm		12 mm	
Spindle pitch	2 mm/U; 6 mm/U		3 mm/U; 8 mm/U		3 mm/U; 10 mm/U		5 mm/U; 12 mm/U	

Mass moment of inertia for EGSC-BS-25/32

$$J_A = J_O + J_H \cdot l + J_L \cdot m$$

The mass moment of inertia J of the mini slide is calculated as follows.

l = working stroke

m = moving payload

Size	25		32	
Spindle pitch	2 mm/U		3 mm/U	
Mass moment of inertia J _O	0.00087 kgcm ²		0.00144 kgcm ²	
Mass moment of inertia J _H per metre of stroke	0.00529 kgcm ²		0.01507 kgcm ²	
Mass moment of inertia J _L per kg of working load	0.00101 kgcm ²		0.00912 kgcm ²	

Datasheet

Mass moment of inertia for EGSC-BS-45/60

$$J_A = J_O + J_H \cdot l + J_L \cdot m$$

The mass moment of inertia J of the mini slide is calculated as follows.

l = working stroke

m = moving payload

Size	45		60	
Spindle pitch	3 mm/U	10 mm/U	5 mm/U	12 mm/U
Mass moment of inertia JO	0.01045 kgcm ²	0.01363 kgcm ²	0.06624 kgcm ²	0.08386 kgcm ²
Mass moment of inertia JH per metre of stroke	0.04918 kgcm ²	0.13609 kgcm ²	0.11539 kgcm ²	0.27076 kgcm ²
Mass moment of inertia JL per kg of working load	0.0028 kgcm ²	0.02533 kgcm ²	0.00633 kgcm ²	0.03648 kgcm ²

Homing

Homing can be carried out in two ways:

- against the fixed stop
- via reference switch

The following values must be observed:

Size	25	32	45	60
Impact energy in end positions	0 mJ	0.01 mJ		0.04 mJ

Materials

Material housing	Anodised wrought aluminium alloy
Material yoke plate	Wrought aluminium alloy, Anodised wrought aluminium alloy
Material slide	Anodised wrought aluminium alloy
Material guide rail	Rolled steel
Material guide slide	Rolled steel
Material spindle	Rolled steel
Material spindle nut	Rolled steel
Note on materials	RoHS-compliant
LABS (PWIS) conformity	VDMA24364 zone III
Suitability for the production of Li-ion batteries	Metals with more than 1% by mass of copper, zinc or nickel are excluded from use. Exceptions are nickel in steel, chemically nickel-plated surfaces, printed circuit boards, cables, electrical plug connectors and coils, Suitable for battery production according to the Festo internal definition of the degree of severity F1A with restrictions regarding the use of Cu/Zn/Ni

Permissible forces and torques for the guide calculation with a service life of 5 x 10⁶ cycles and max. stroke

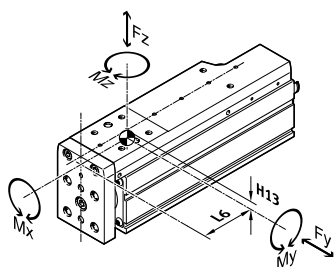

The indicated forces and torques refer to the centre of the guide. The point of application is the intersection of the centre of the guide and the centre of the length of the slide. They must not be exceeded in dynamic operation. Special attention must be paid to the deceleration process.

Distance to the centre of the guide:

Sizes: 25/32/45/60

Dimension H13: 7.3 mm/7.9 mm/10.2 mm/15.9 mm

Dimension L6: 25.1 mm/31.8 mm/37.3 mm/53.4 mm

Size	25	32	45	60
Max. force Fy	669 N	991 N	1,314 N	4,937 N
Max. force Fz	669 N	991 N	1,314 N	4,937 N
Max. moment Mx	2 Nm	3.4 Nm	8.1 Nm	20 Nm
Max. moment My	2.1 Nm	3.2 Nm	7 Nm	30 Nm
Max. moment Mz	2.1 Nm	3.2 Nm	7 Nm	30 Nm

Datasheet

Calculating the load-comparison factor

$$f_v = \frac{|F_{y1}|}{F_{y2}} + \frac{|F_{z1}|}{F_{z2}} + \frac{|M_{x1}|}{M_{x2}} + \frac{|M_{y1}|}{M_{y2}} + \frac{|M_{z1}|}{M_{z2}} \leq 1$$

If the axis is subjected to several of the indicated forces and torques at the same time, the following equation must be satisfied in addition to the indicated maximum loads.

For a guide system to have a service life of 5×10^6 cycles, the load comparison factor must have a value of $f_v < 1$, based on the maximum permissible forces and torques for a service life of 5×10^6 cycles. This formula can be used to calculate a guide value. The sizing software 'Electric Motion Sizing' is available for more precise calculations.

F1 / M1 = dynamic value

F2 / M2 = maximum value

Service life of the guide

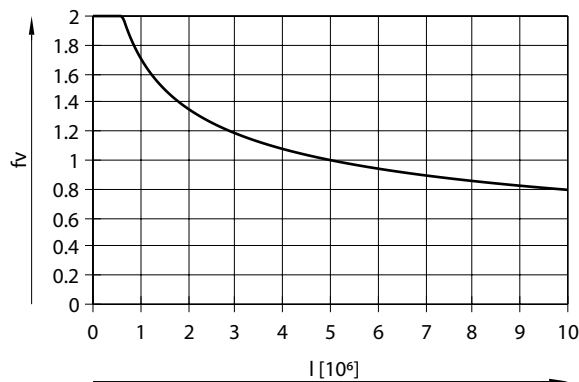

The service life of the guide depends on the load. To be able to provide an indication of the service life, the graph below plots the load comparison factor f_v against the service life.

These values are only theoretical. You must consult your local Festo contact for a load comparison factor f_v greater than 1.

Example:

A user wants to move a load of X kg. The calculation gives a value of 1.5 for the load comparison factor f_v . According to the graph, the guide would have a service life of approx. 1.5×10^6 cycles. Reducing the acceleration reduces the M_z and M_y values. A load comparison factor f_v of 1 now gives a service life of 5×10^6 cycles.

Permissible forces and torques at a theoretical service life of 100 km (pure guide load)

The characteristic load values of the bearing guides are standardised to ISO and JIS using dynamic and static forces and torques. These forces and torques are based on an expected service life of the guide system of 100 km to ISO or 50 km to JIS. As the characteristic load values are dependent on the service life, the maximum permissible forces and torques for a 5000 km service life cannot be compared with the dynamic forces and torques of roller guides to ISO/JIS.

To make it easier to compare the guide capacity of linear axes ELGC with bearing guides, the table below lists the theoretically permissible forces and torques for a calculated service life of 100 km. This corresponds to the dynamic forces and torques to ISO. These 100 km values have been calculated mathematically and are only to be used for comparing with dynamic forces and torques to ISO. The drives must not be loaded with these characteristic values as this could damage the axes.

Size	25	32	45	60
F _y at theoretical life value of 100 km (only guide consideration)	1,310 N	2,135 N	3,240 N	13,400 N
F _z at theoretical life value of 100 km (only guide consideration)	1,310 N	2,135 N	3,240 N	13,400 N
M _x at theoretical life value of 100 km (only guide consideration)	5 Nm	10 Nm	20 Nm	107 Nm
M _y at theoretical life value of 100 km (only guide consideration)	4 Nm	7 Nm	17 Nm	117 Nm
M _z at theoretical life value of 100 km (only guide consideration)	4 Nm	7 Nm	17 Nm	117 Nm

Datasheet

Speed v as a function of stroke l for size 25

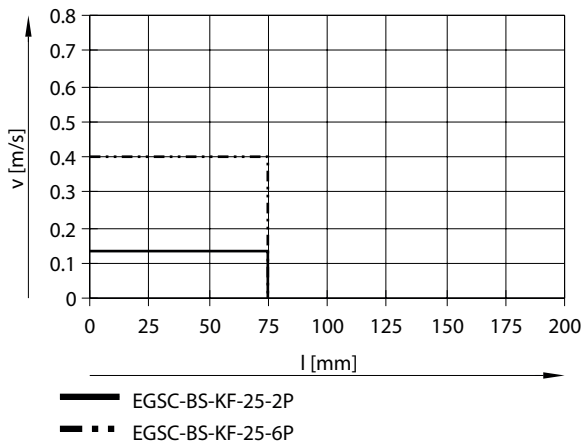

Speed v as a function of stroke l for size 32

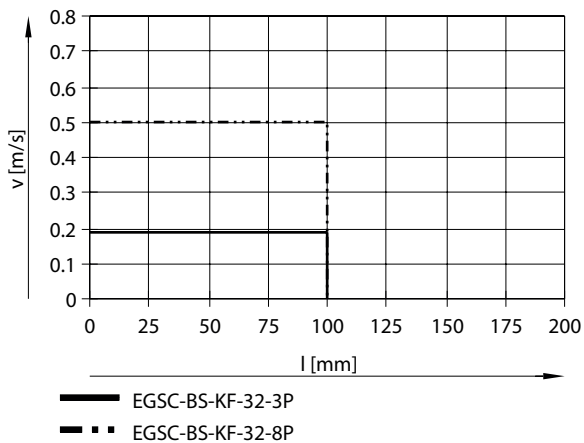

Speed v as a function of stroke l for size 45

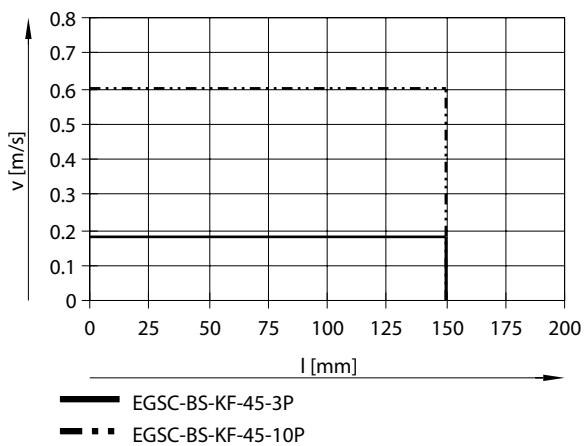

Datasheet

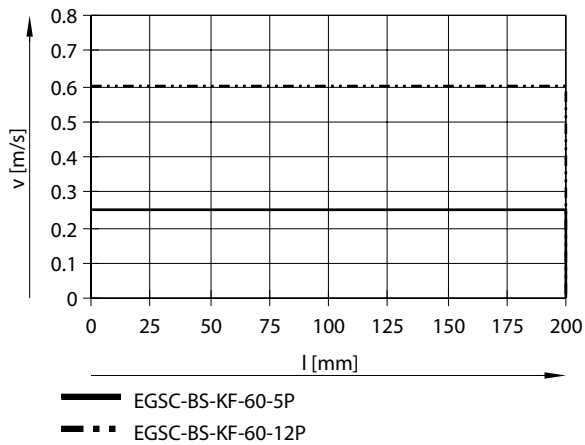
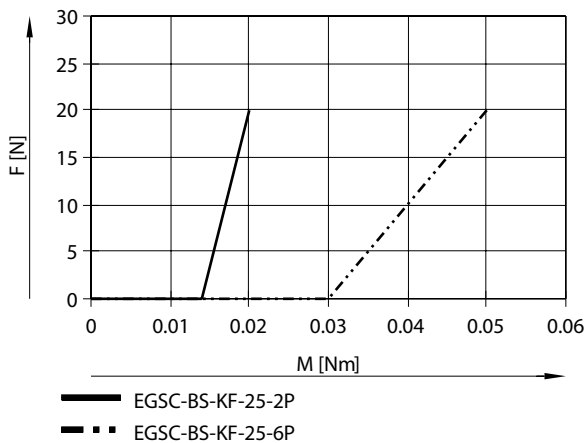
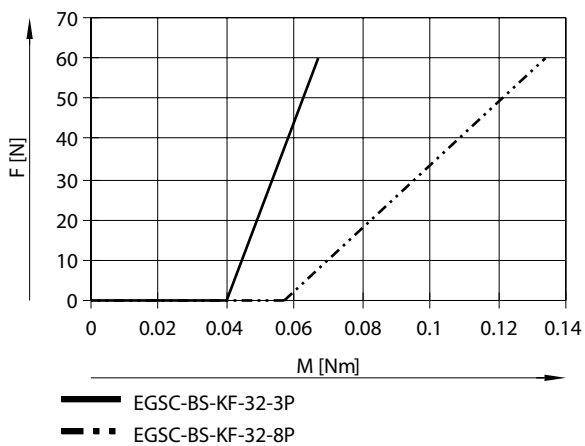
Speed v as a function of stroke l for size 60Feed force F as a function of input torque M for size 25Feed force F as a function of input torque M for size 32

Datasheet

Feed force F as a function of input torque M for size 45

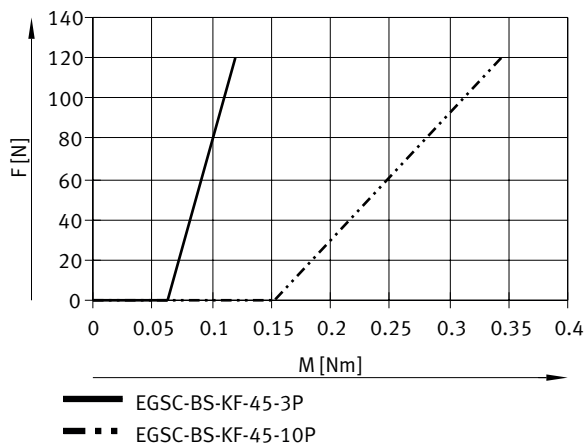

Feed force F as a function of input torque M for size 60

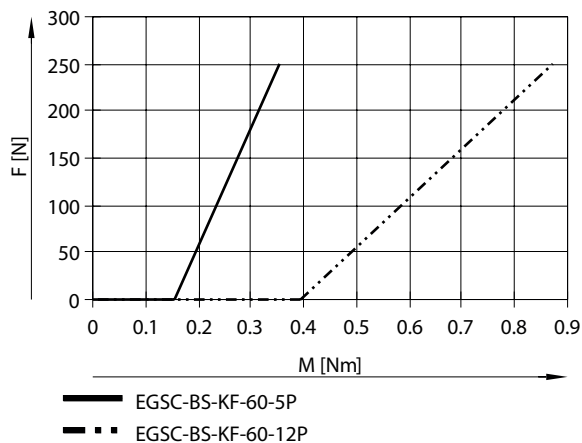

Feed force F as a function of service life l

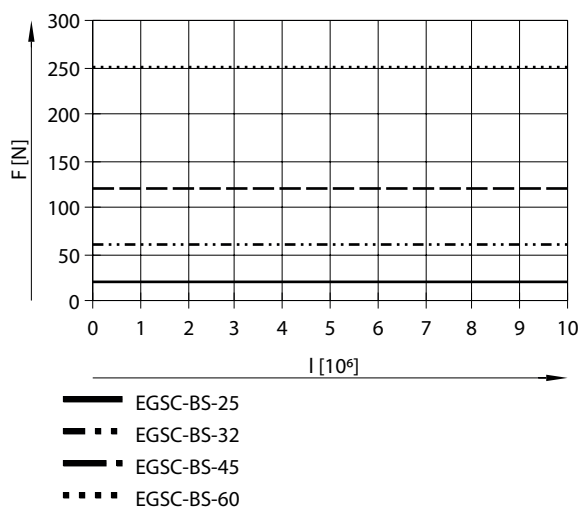

Datasheet

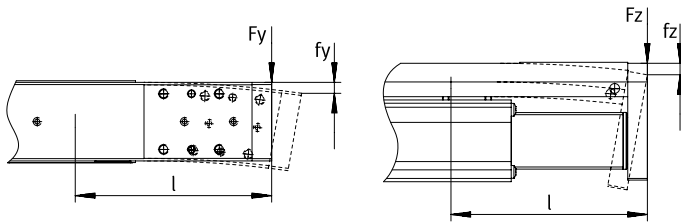
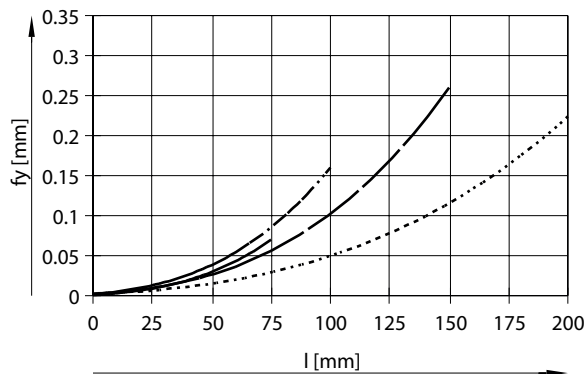
Deflection f on the guide rail as a function of stroke l Deflection f_y 

- EGSC-BS-KF-25-6P
- - - EGSC-BS-KF-32-8P
- · - EGSC-BS-KF-45-10P
- · · EGSC-BS-KF-60-12P

F_y for which the characteristic curves were determined:

- EGSC-BS-25: 10 N
- EGSC-BS-32: 20 N
- EGSC-BS-45: 40 N
- EGSC-BS-60: 60 N

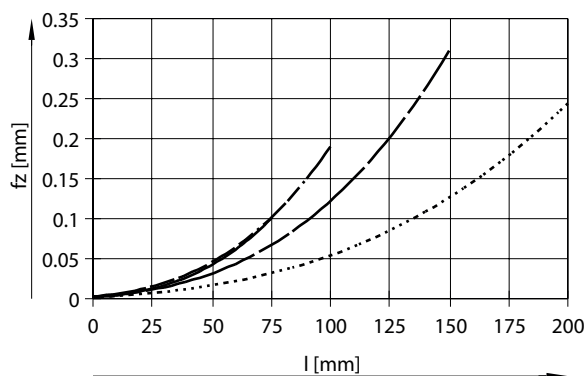
Deflection f_z 

- EGSC-BS-KF-25-6P
- - - EGSC-BS-KF-32-8P
- · - EGSC-BS-KF-45-10P
- · · EGSC-BS-KF-60-12P

F_z for which the characteristic curves were determined:

- EGSC-BS-25: 10 N
- EGSC-BS-32: 20 N
- EGSC-BS-45: 40 N
- EGSC-BS-60: 60 N

Datasheet

Combinations between axis ELGC, ELGS, mini slide EGSC-BS, EGSS-BS, electric cylinder EPCC, EPCS and guide axis ELFC

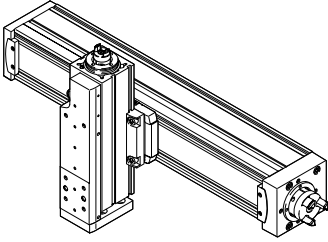

Mounting options with profile mounting EAHF-L2-...-P-D
 - Mounting option: Base axis with next smaller assembly axis

1. Base axis:
 Product: ELGC, ELGS, ELFC
 For size 32, 45, 60, 80
2. Assembly axis:
 Product: ELGC, ELGS, EGSC, EGSS, EPCC, EPCS, ELFC
 For size 25, 32, 45, 60

Combinations between axis ELGC, ELGS, mini slide EGSC-BS, EGSS-BS, electric cylinder EPCC, EPCS and guide axis ELFC

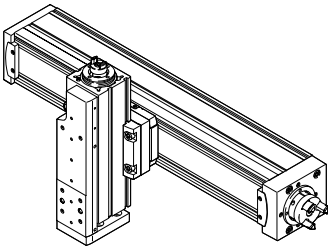

Mounting options with adapter kit EHAA-D-L2
 - Mounting option: Base axis with assembly axis of the same size
 - Mounting option: Base axis with height compensation for the next smaller assembly axis
 - When motors are mounted using parallel kits, interfering contours may occur. In this case, the adapter plate is required for height compensation

1. Base axis:
 Product: ELGC, ELGS, ELFC
 For size 32, 45, 60, 80
2. Assembly axis:
 Product: ELGC, ELGS, EGSC, EGSS, EPCC, EPCS, ELFC
 Sizes 25, 32, 45, 60, 80

Combinations between axis ELGC, ELGS, mini slide EGSC-BS, EGSS-BS, electric cylinder EPCC, EPCS and guide axis ELFC

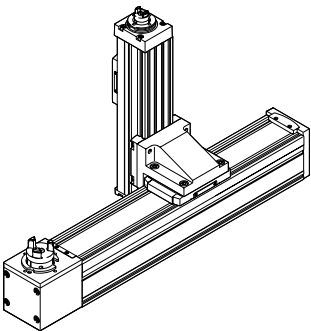

Mounting options with angle kit EHAA-D-L2-...-AP
 - Mounting option: Base axis with next smaller assembly axis

1. Base axis:
 Product: ELGC, ELGS, ELFC
 For size 32, 45, 60, 80
2. Assembly axis:
 Product: ELGC, ELGS, EGSC, EGSS, EPCC, EPCS, ELFC
 For size 25, 32, 45, 60

Combinations between mini slides EGSC-BS, EGSS-BS

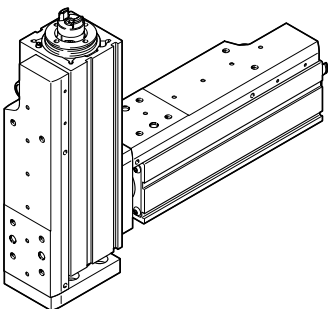

Mounting options with direct fastening
 - Mounting option: Base axis with the same size assembly axis

1. Base axis:
 Product: EGSC, EGSS
 For size 25, 32, 45, 60
2. Assembly axis:
 Product: EGSC, EGSS
 For size 25, 32, 45, 60

Dimensions

Dimensions – Size 25/32/45

Download CAD data www.festo.com

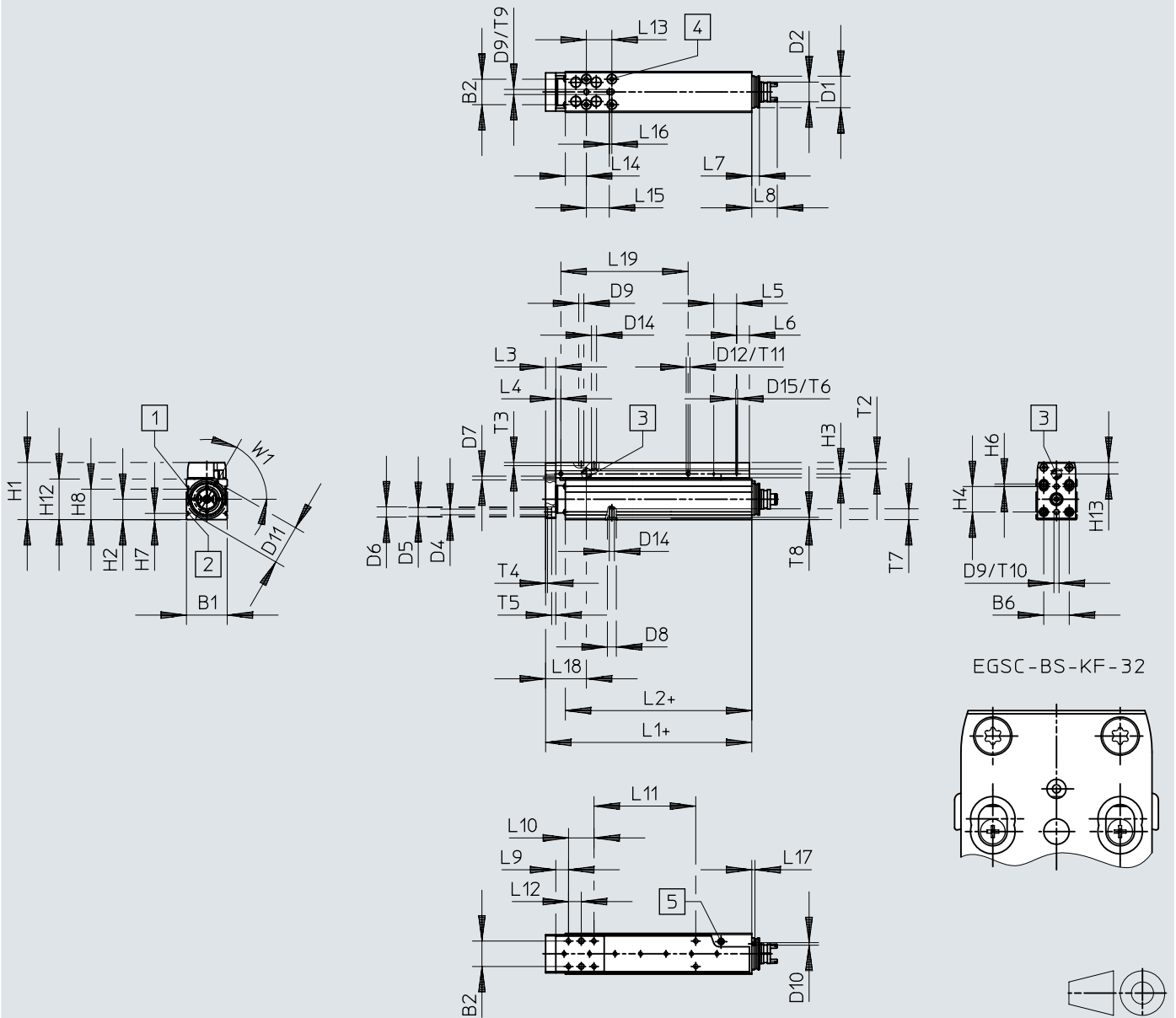

- [1] = Slot for sensor bracket
- [2] = Mounting slot
- [3] Guide centre
- [4] Mounting thread sealed on delivery

EGSC-BS-KF-32

Dimensions

	B1 ±0,15	B2	B6	D1 ∅	D2 ¹⁾ ∅	D4 ∅ H13	D5 ∅ H7	D6 ∅ H13	D7 ∅	D8 ∅ H7	D9 ∅ H8	D10 ∅	D11 ∅	D12 ∅
EGSC-BS-KF-25	25	17	17	20,5	10,8	3,4	5	6	2,5	5	2	2	25	3
EGSC-BS-KF-32	32	20	20	25	15,5	4,5	7	8	3	7	4	2	31	3
EGSC-BS-KF-45	45	25	25	32	16,3	5,5	7	10	3	7	5	3	41	3

	D14	D15	H1	H2	H3	H4	H6	H7	H8	H12 ±0,15	H13	L1	L2	L3 +0,2
EGSC-BS-KF-25	M3	M1,6	36,5	12,5	2,5	17	–	4,9	20,5	25	7,6	53,6	42	6
EGSC-BS-KF-32	M4	M1,6	45	16	3	20	2	4,9	24	32	8,4	62	46,5	8
EGSC-BS-KF-45	M5	M2	60,5	22,5	3	25	–	6,1	28,5	45	10,7	73,8	54,5	10

	L4	L5 ±0,1	L6	L7	L8	L9	L10	L12	L13	L14	L15	L16	L17
EGSC-BS-KF-25	4	18	6	5	15	10	17	8,5	17	13,5	16,5	1	2,5
EGSC-BS-KF-32	4	18	10	6	19,9	10	20	10	20	16,5	18	2	2,5
EGSC-BS-KF-45	4	24	12	6	19,9	15	25	12,5	25	17,5	24	2	2

	L18	T2	T3 +0,1	T4 +0,1	T5	T6	T7	T8 +0,1	T9 +0,1	T10 +0,1	T11 –0,2	W1	≈ 1
EGSC-BS-KF-25	25,1	4,5	2,6	1,3	3,2	2	6	1,3	2,1	3,1	2	60°	6
EGSC-BS-KF-32	31,8	5	2,6	1,6	3,2	1,5	8,5	1,8	2,6	2,6	1,5	60°	6
EGSC-BS-KF-45	37,3	6	1,3	1,6	5,4	4	7	1,8	1,3	1,3	5	60°	12

	L ²⁾	L19	L11
EGSC-BS-KF-25	25	25	0
	50	50	33
	75	75	58
EGSC-BS-KF-32	25	25	0
	50	50	30
	75	75	55
	100	100	80
EGSC-BS-KF-45	25	25	0
	50	50	25
	75	75	50
	100	100	75
	125	125	100
	150	150	125

1) Coupling diameter or interference circuit diameter clamping screw

2) Stroke

Dimensions

Dimensions – Size 60

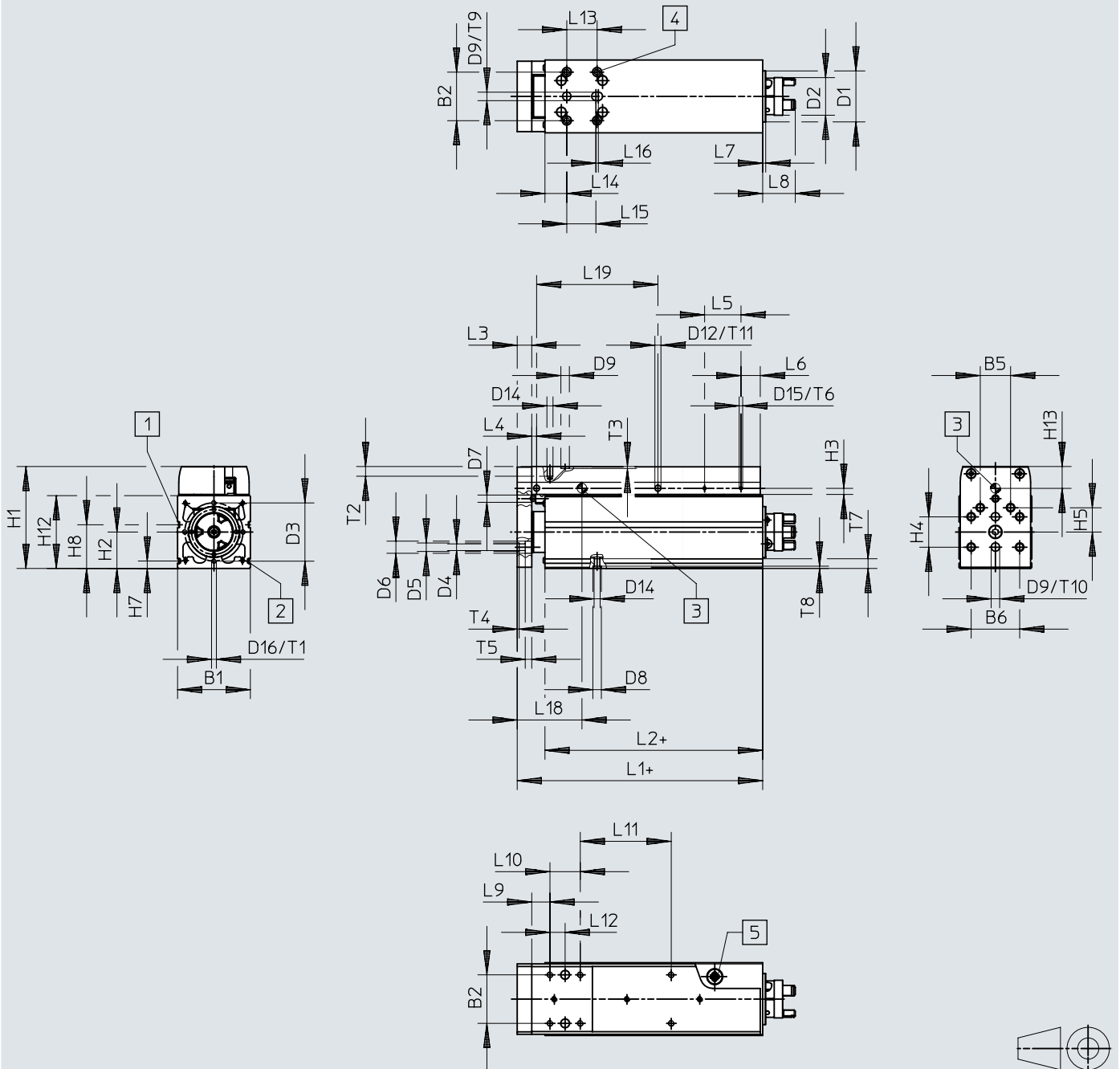
Download CAD data www.festo.com

- [1] = Slot for sensor bracket
- [2] = Mounting slot
- [3] Guide centre
- [4] Mounting thread sealed on delivery

Dimensions

	B1 ±0,15	B2	B5	B6	D1 ∅	D2 ¹⁾ ∅	D3 ∅	D4 ∅ H13	D5 ∅ H7	D6 ∅ H13	D7 ∅	D8 ∅ H7	D9 ∅ H8
EGSC-BS-KF-60	60	40	25	40	42	31,4	48	5,5	7	10	6	7	7

	D12 ∅	D13	D14	D15	D16	H1	H2	H3	H4	H5	H7	H8	H12 ±0,15	H13
EGSC-BS-KF-60	5	M4	M5	M3	M4	84	30	5	25	20	6,1	36	60	16,4

	L1	L2	L3 +0,2	L4	L5 ±0,1	L6	L7	L8	L9	L10	L12	L13	L14	L15
EGSC-BS-KF-60	102,4	79,5	12	4	30	16	2,5	26,9	15	25	12,5	25	30	24

	L16	L18	T1	T2	T3 +0,1	T4 +0,1	T5	T6	T7	T8 +0,1	T9 +0,1	T10 +0,1	T11 -0,2	≈G 1
EGSC-BS-KF-60	2	53,4	10	8	1,6	1,6	5,4	6	8	1,8	1,6	1,6	5	15

	L ²⁾	L19	L11
EGSC-BS-KF-60	50	50	25
	75	75	50
	100	100	75
	125	125	100
	150	150	125
	200	200	175

1) Coupling diameter or interference circuit diameter clamping screw

2) Stroke

Dimensions

Dimensions – Profile mounting EAHF-L2-...-P-S

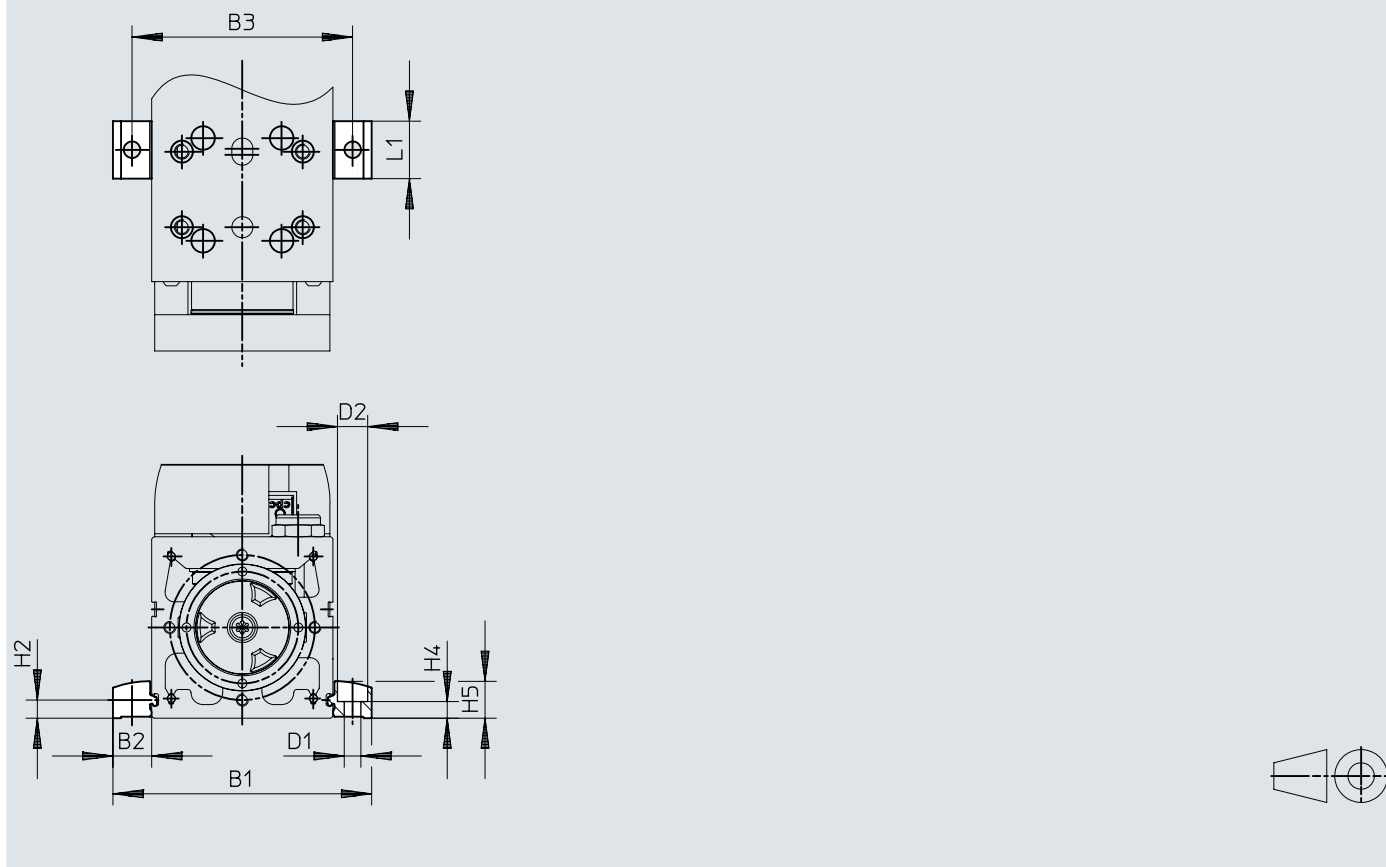
Download CAD data www.festo.com

		B1	B2	B3	D1 ∅ H13	D2 ∅ H13	H2	H4 ±0,1	H5	L1
EAHF-L2-25-P-S	EGSC-BS-KF-25	44,4	9,7	35	4,5	8	4,9	4,2	9	19
	EGSC-BS-KF-32	51,4	9,7	42	4,5	8	4,9	4,2	9	19
EAHF-L2-45-P-S	EGSC-BS-KF-45	70,6	12,8	58	5,5	10	6,1	5,5	12,2	19
	EGSC-BS-KF-60	85,6	12,8	73	5,5	10	6,1	5,5	12,2	19

Dimensions

Dimensions – Profile mounting EAHF-L2-...-P

Download CAD data www.festo.com

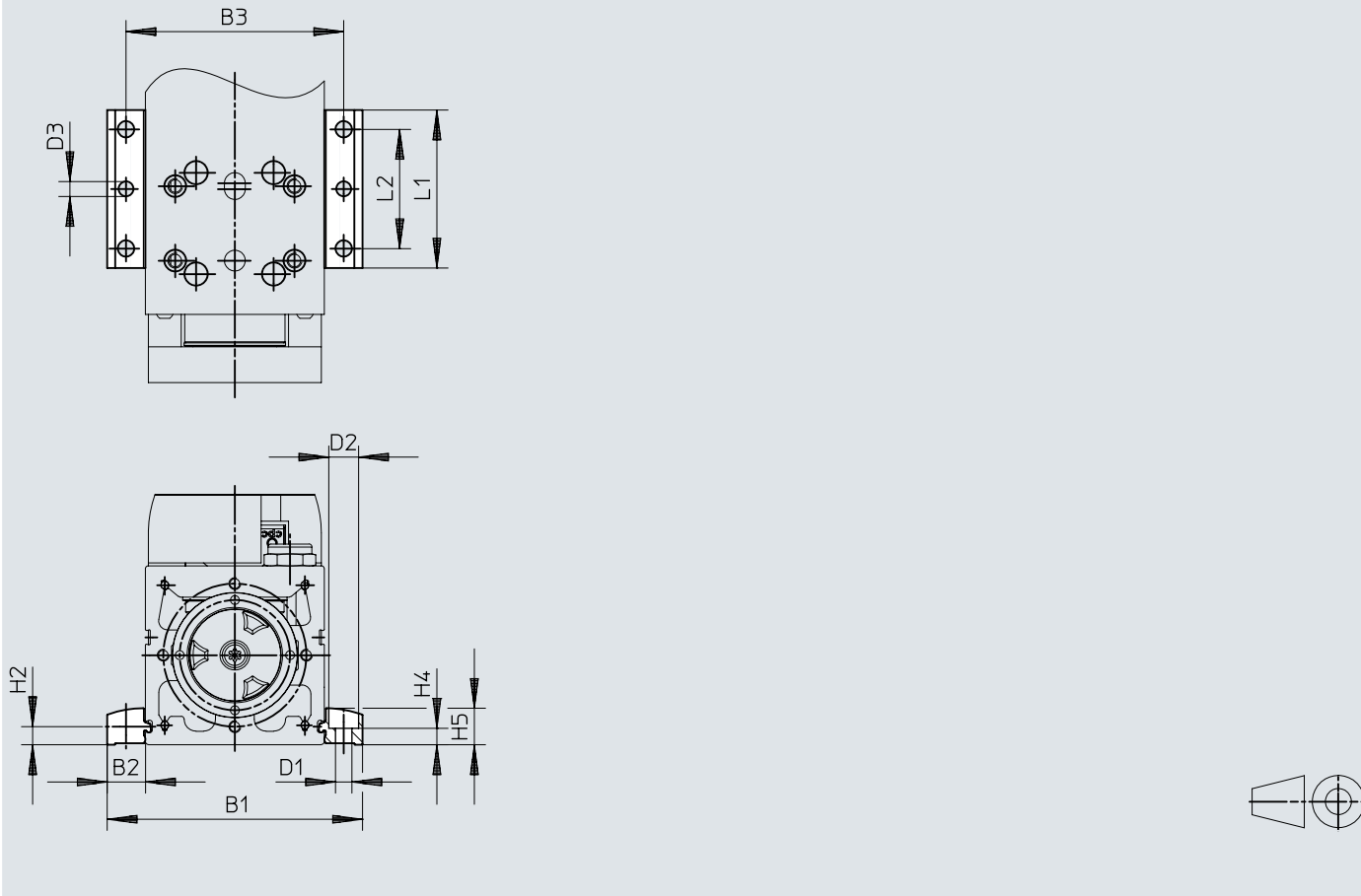

		B1	B2	B3	D1	D2	D3	H2	H4	H5	L1	L2
					∅ H13	∅ H13	∅		±0,1			
EAHF-L2-25-P	EGSC-BS-KF-25	44,4	9,7	35	4,5	8	4	4,9	4,2	9	53	40
	EGSC-BS-KF-32	51,4	9,7	42	4,5	8	4	4,9	4,2	9	53	40
EAHF-L2-45-P	EGSC-BS-KF-45	70,6	12,8	58	5,5	10	5	6,1	5,5	12,2	53	40
	EGSC-BS-KF-60	85,6	12,8	73	5,5	10	5	6,1	5,5	12,2	53	40

Dimensions

Dimensions – Switch lug EAPM-...-SLS

Download CAD data www.festo.com

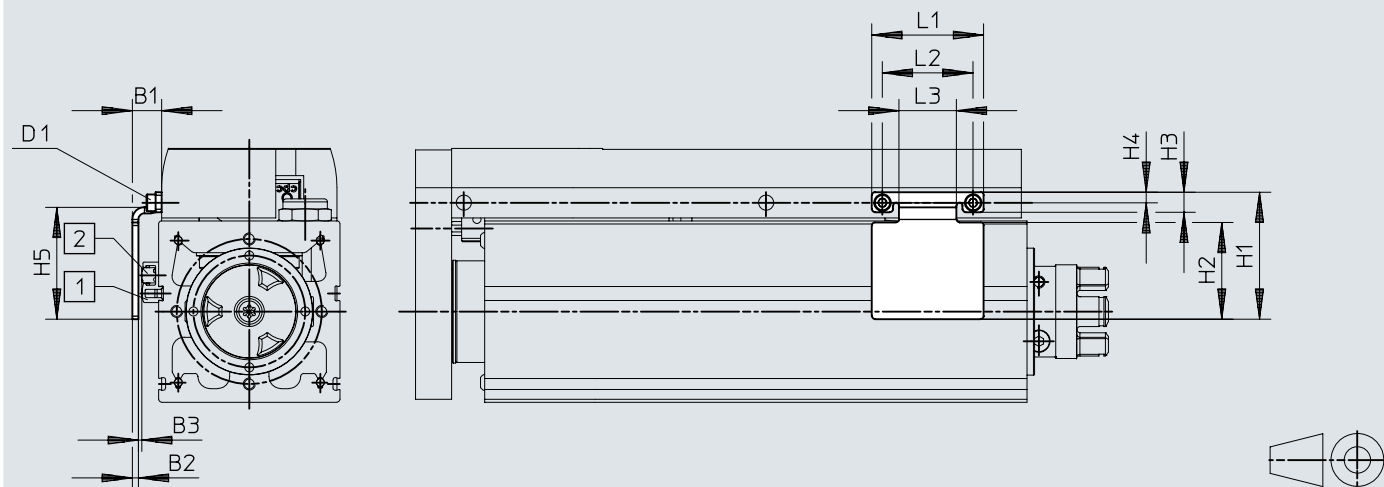

- [1] Sensor bracket
- [2] Proximity switch

		B1	B2	B3	D1	H1	H2	H3	H4	H5	L1	L2	L3
EAPM-E19-25-SLS	EGSC-BS-KF-25	9,2	2	1,0±0,32	M1,6	21	13	4,3	2,5	18	22	18	10
EAPM-L2-32-SLS	EGSC-BS-KF-32	9,2	2	1,0±0,26	M1,6	27	19	4,3	2,5	24	22	18	10
EAPM-L2-45-SLS	EGSC-BS-KF-45	9,4	2	0,7±0,26	M2	37	28	5,5	3,3	33	30	24	14
EAPM-L2-60-SLS	EGSC-BS-KF-60	9,7	2	0,7±0,31	M3	42	32	6,6	3,5	37	37	30	19

Dimensions

Dimensions – Sensor bracket EAPM-L2

Download CAD data www.festo.com

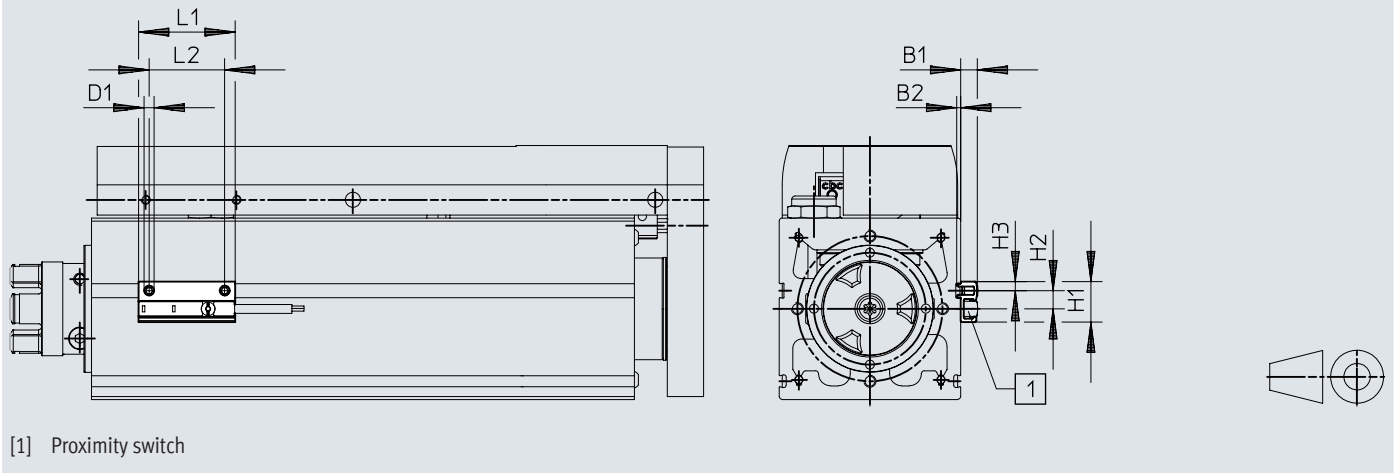

[1] Proximity switch

		B1	B2	D1	H1	H2	H3	L1	L2
EAPM-L2-SH	EGSC-BS-KF-25	5,5	1,3	M4	13,4	6	3	32	25
	EGSC-BS-KF-32								
	EGSC-BS-KF-45								
	EGSC-BS-KF-60								

Ordering data

with recirculating ball bearing guide						
Size	Spindle pitch	Working stroke	Part no.	Type		
25	2 mm/U	25 mm	8162069	EGSC-BS-KF-25-25-2P		
		50 mm	8162070	EGSC-BS-KF-25-50-2P		
		75 mm	8162071	EGSC-BS-KF-25-75-2P		
	6 mm/U	25 mm	★ 8048310	EGSC-BS-KF-25-25-6P		
		50 mm	8048311	EGSC-BS-KF-25-50-6P		
		75 mm	★ 8061280	EGSC-BS-KF-25-75-6P		
32	3 mm/U	25 mm	8162073	EGSC-BS-KF-32-25-3P		
		50 mm	8162074	EGSC-BS-KF-32-50-3P		
		75 mm	8162075	EGSC-BS-KF-32-75-3P		
		100 mm	8162072	EGSC-BS-KF-32-100-3P		
	8 mm/U	25 mm	★ 8048306	EGSC-BS-KF-32-25-8P		
		50 mm	★ 8048307	EGSC-BS-KF-32-50-8P		
		75 mm	★ 8048308	EGSC-BS-KF-32-75-8P		
		100 mm	★ 4356032	EGSC-BS-KF-32-100-8P		
		45	3 mm/U	25 mm	8162079	EGSC-BS-KF-45-25-3P
				50 mm	8162080	EGSC-BS-KF-45-50-3P
75 mm	8162081			EGSC-BS-KF-45-75-3P		
100 mm	8162076			EGSC-BS-KF-45-100-3P		
125 mm	8162077			EGSC-BS-KF-45-125-3P		
150 mm	★ 8162078			EGSC-BS-KF-45-150-3P		
10 mm/U	25 mm	★ 8048300	EGSC-BS-KF-45-25-10P			
	50 mm	★ 8048301	EGSC-BS-KF-45-50-10P			
	75 mm	★ 8048302	EGSC-BS-KF-45-75-10P			
	100 mm	★ 4022926	EGSC-BS-KF-45-100-10P			
	125 mm	★ 8048303	EGSC-BS-KF-45-125-10P			
	150 mm	★ 8048304	EGSC-BS-KF-45-150-10P			
60	5 mm/U	50 mm	★ 8162086	EGSC-BS-KF-60-50-5P		
		75 mm	★ 8162087	EGSC-BS-KF-60-75-5P		
		100 mm	★ 8162082	EGSC-BS-KF-60-100-5P		
		125 mm	8162083	EGSC-BS-KF-60-125-5P		
		150 mm	8162084	EGSC-BS-KF-60-150-5P		
		200 mm	★ 8162085	EGSC-BS-KF-60-200-5P		
	12 mm/U	50 mm	★ 8048362	EGSC-BS-KF-60-50-12P		
		75 mm	★ 8048363	EGSC-BS-KF-60-75-12P		
		100 mm	★ 4356469	EGSC-BS-KF-60-100-12P		
		125 mm	★ 8048364	EGSC-BS-KF-60-125-12P		
		150 mm	★ 8048365	EGSC-BS-KF-60-150-12P		
		200 mm	★ 8048366	EGSC-BS-KF-60-200-12P		

Peripherals

Peripherals overview

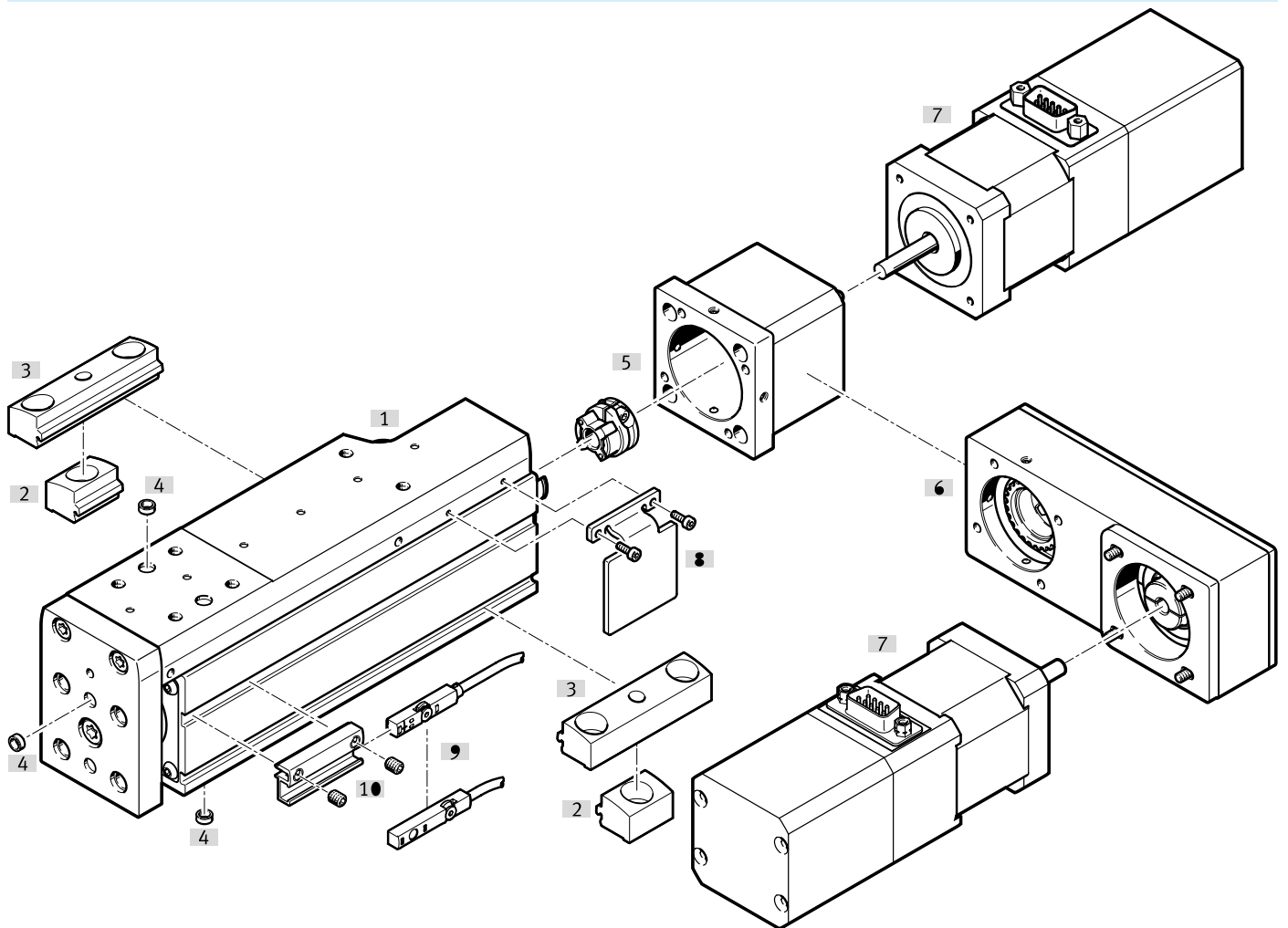

Accessories		→ Link
Type/order code	Description	
[1] Mini slide EGSC-BS	egsc	egsc
[2] Profile mounting EAHF-L2-...-P-S	For mounting the axis on the side of the profile	23
[3] Profile mounting EAHF-L2-...-P	For mounting the axis on the side of the profile. The profile mounting can be attached to the mounting surface using the drilled hole in the centre	23
[4] Centring sleeve ZBS	For centring loads and attachments on the slide	23
[4] Centring pin ZBH	For centring loads and attachments on the slide	24
[5] Axial kit EAMM-A	For axial motor mounting More detailed information → www.festo.com/x/electric-motion-sizing	eamm-a
[6] Parallel kit EAMM-U	For parallel motor mounting More detailed information → www.festo.com/x/electric-motion-sizing	eamm-u
[7] Motor EMMS-ST	Motors specially matched with the axis More detailed information → www.festo.com/x/electric-motion-sizing	emms-st
[8] Switch lug EAPM-L2-...-SLS	For sensing the slide position in conjunction with inductive proximity switches SIES-8M	23
[9] Proximity switch SIES-8M	Inductive proximity sensors, for T-slot	24
[9] Proximity switches SMT-8M	Magnetic proximity switches, for T-slot	24
[10] Sensor bracket EAPM-L2-SH	For mounting the proximity switches on the axis. The proximity switches can only be mounted using the sensor bracket	23

Accessories

Permitted axis/motor combinations for axial and parallel kits

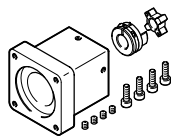

By following these links you will find all the information on:

- Axis/motor combinations
- Permitted third-party motors
- Technical data
- Dimensions

For axial kits → Internet: www.festo.com/catalogue/eamm-a

For parallel kits → Internet: www.festo.com/catalogue/eamm-u

Profile mounting EAHF-L2-...-P-S

	Description	Suitability for the production of Li-ion batteries ¹⁾	Material plate	Product weight	Part no.	Type
	For sizes 25 and 32	F1a	Anodised wrought aluminium alloy	4 g	5183153	EAHF-L2-25-P-S
	For size 45, 60			6 g	5184133	EAHF-L2-45-P-S

1) More information www.festo.com/x/topic/bat

Profile mounting EAHF-L2-...-P

	Description	Suitability for the production of Li-ion batteries ¹⁾	Material plate	Product weight	Part no.	Type
	For sizes 25 and 32	F1a	Anodised wrought aluminium alloy	19 g	4835684	EAHF-L2-25-P
	For size 45, 60			35 g	4835728	EAHF-L2-45-P

1) More information www.festo.com/x/topic/bat

Switch lug EAPM-L2-SLS

	Description	Suitability for the production of Li-ion batteries ¹⁾	Material switch lug	Product weight	Part no.	Type
	For size 25	F1a		8 g	8067258	EAPM-E19-25-SLS
	For size 32			10 g	8067259	EAPM-L2-32-SLS
	For size 45			18 g	8067260	EAPM-L2-45-SLS
	For size 60			27 g	8067261	EAPM-L2-60-SLS

1) More information www.festo.com/x/topic/bat

Sensor bracket EAPM-L2-SH

	Description	Suitability for the production of Li-ion batteries ¹⁾	Material sensor bracket	Product weight	Part no.	Type
	For sizes 25, 32, 45, 60	F1a	Anodised wrought aluminium alloy	4 g	4759852	EAPM-L2-SH

1) More information www.festo.com/x/topic/bat

Centring pin ZBS-2

	Description	Material sleeve	Size of pack	Product weight	Part no.	Type
	For size 25	Steel	10	1 g	525273	ZBS-2

Accessories

Centring pin ZBS-4

	Description	Material sleeve	Size of pack	Product weight	Part no.	Type
	For size 32	High-alloy stainless steel	10	0.5 g	562959	ZBS-4

Centring sleeve ZBH-5

	Description	Material sleeve	Size of pack	Product weight	Part no.	Type
	For size 25, 45	Steel	10	1 g	8146543	ZBH-5-B

Centring sleeve ZBH-7

	Description	Material sleeve	Size of pack	Product weight	Part no.	Type
	For sizes 32, 45, 60	Steel	10	1 g	8146544	ZBH-7-B

Push-in fitting QSM

	Description	Material housing	Size of pack	Product weight	Part no.	Type
	For size 25, 32	Brass, nickel-plated	10	3 g	★ 133004	QSM-M5-4-I-R
				3.2 g	133003	QSM-M5-3-I-R
	For size 45			8.9 g	186266	QSM-G1/8-4-I
				9.5 g	★ 186267	QSM-G1/8-6-I
	For size 60			13 g	★ 186108	QS-G1/4-6-I
				14 g	★ 186110	QS-G1/4-8-I

Proximity switch SIES for T-slot, inductive

Link [sies-8m](#)

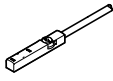
	Switching output	Electrical connection 1, connector system	Switching element function	Cable length	Part no.	Type
	NPN	M8x1, A-coded, to EN 61076-2-104	N/C contact	0.3 m	551402	SIES-8M-NO-24V-K-0,3-M8D
			N/O contact		551397	SIES-8M-NS-24V-K-0,3-M8D
		Open end	N/C contact	7.5 m	551401	SIES-8M-NO-24V-K-7,5-OE
			N/O contact		551396	SIES-8M-NS-24V-K-7,5-OE
	PNP	M8x1, A-coded, to EN 61076-2-104	N/C contact	0.3 m	★ 551392	SIES-8M-PO-24V-K-0,3-M8D
			N/O contact		★ 551387	SIES-8M-PS-24V-K-0,3-M8D
		Open end	N/C contact	7.5 m	★ 551391	SIES-8M-PO-24V-K-7,5-OE
			N/O contact		★ 551386	SIES-8M-PS-24V-K-7,5-OE

Proximity switch SMT for T-slot, magneto-resistive

Link [smt-8m](#)

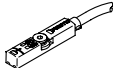
	Type of mounting	Switching output	Electrical connection	Cable length	Part no.	Type
	Screw-clamped, Insertable in the slot from above	3-wire PNP N/C contact	Open end	7.5 m	574340	SMT-8M-A-PO-24V-E-7,5-OE
				2.5 m	★ 574335	SMT-8M-A-PS-24V-E-2,5-OE
		3-wire PNP N/O contact	Plug M8, A-coded	0.3 m	★ 574334	SMT-8M-A-PS-24V-E-0,3-M8D

Connecting cable NEBA, straight

Link [neba](#)

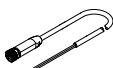
	Electrical connection 1, connector system	Electrical connection 2, connector system	Electrical connection 2, number of connections/cores	Cable length	Part no.	Type
	M8x1, A-coded, to EN 61076-2-104	Open end	3	2.5 m	★ 8078223	NEBA-M8G3-U-2.5-N-LE3

Accessories

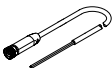
Connecting cable NEBA, straight						Link neba
	Electrical connection 1, connector system	Electrical connection 2, connector system	Electrical connection 2, number of connections/cores	Cable length	Part no.	Type
	M8x1, A-coded, to EN 61076-2-104	Open end	3	5 m	★ 8078224	NEBA-M8G3-U-5-N-LE3

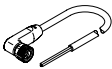
Connecting cable NEBA, angled						Link neba
	Electrical connection 1, connector system	Electrical connection 2, connector system	Electrical connection 2, number of connections/cores	Cable length	Part no.	Type
	M8x1, A-coded, to EN 61076-2-104	Open end	3	2.5 m	★ 8078230	NEBA-M8W3-U-2.5-N-LE3
				5 m	★ 8078231	NEBA-M8W3-U-5-N-LE3