

Pneumatic valves VUWG

FESTO

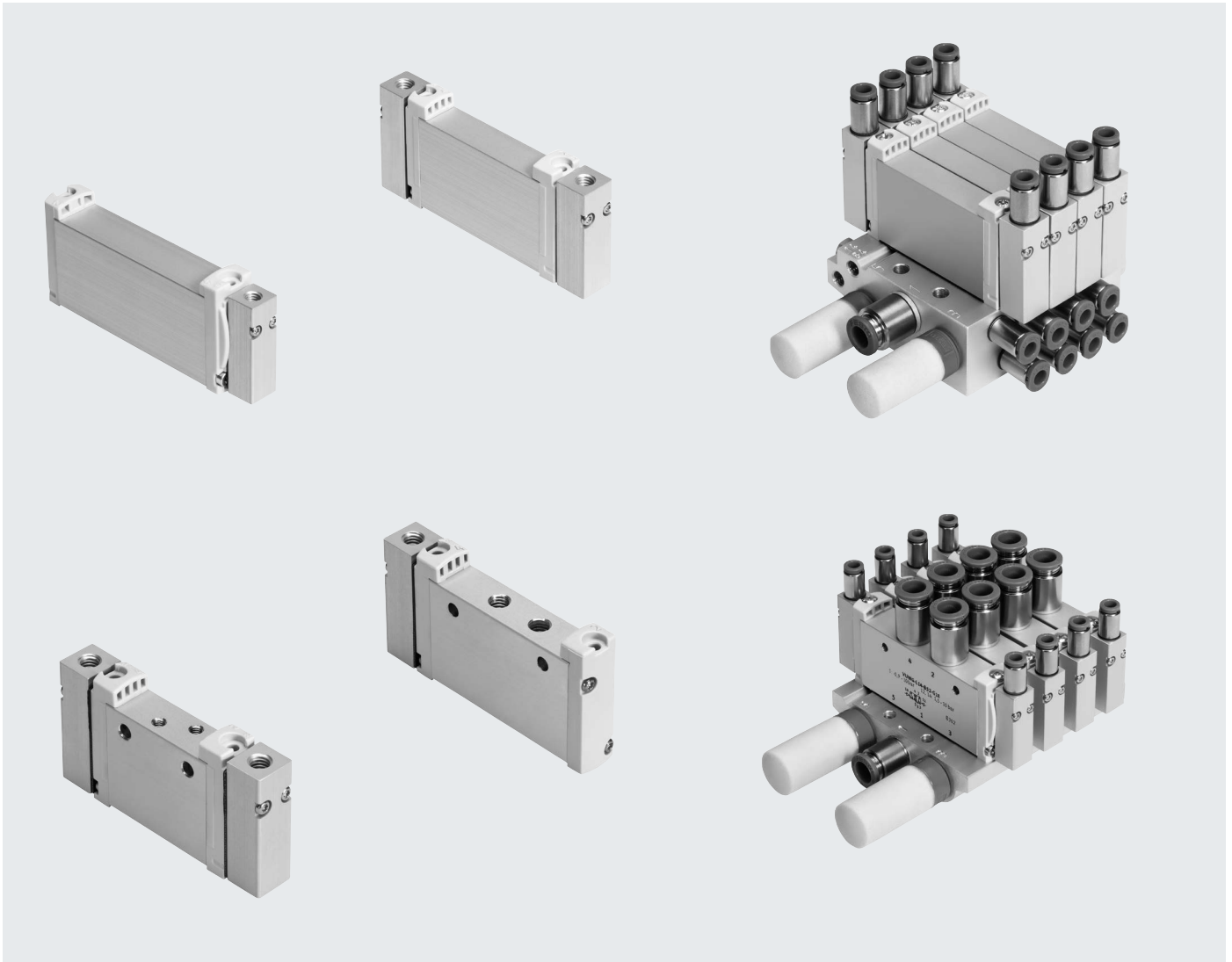

Key features



Innovative

- Various connection sizes (M3, M5, M7, G1/8, G1/4)
- Max. pressure 10 bar
- 2x3/2-way valve in one valve housing

Versatile

- Wide range of valve functions
- In-line valves can be used as individual valves or manifold valves
- M5/ M7 in-line valves can be mixed on one manifold rail
- Identical sub-base valves for M5 or M7 manifold rail
- Manifolds with pressure zones
- Choice of quick push-in connectors

Reliable

- Sturdy and durable metal components
 - Valves
 - Manifold rails
- Reliable servicing thanks to valves that can be replaced quickly and easily

Easy to install

- Solid wall mounting or DIN rail mounting
- Easy installation thanks to captive screws and seals

Key features – Pneumatic components

Individual valves and valve manifold assemblies

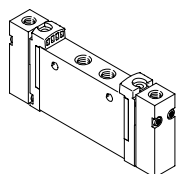

VUWG-L in-line valve as individual valve

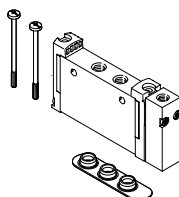

VUWG-S in-line valve for battery assembly

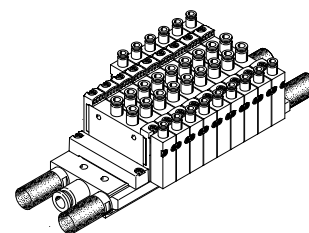

VUWG-S valve manifold assembly consisting of in-line valves

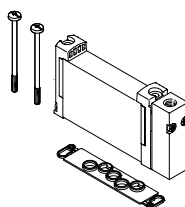

VUWG-B sub-base valve for manifold assembly

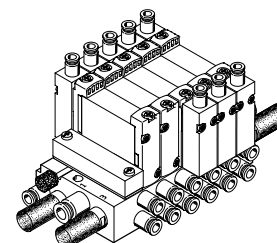

VUWG-B valve manifold assembly using sub-base valves

VUWG basic valves

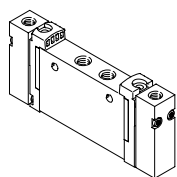

- Width 10, 14 and 18 mm
- 2x 3/2-way, 5/2-way and 5/3-way valves
- In-line valves
- Sub-base valves

Key features – Pneumatic components

Manifold rail for in-line valves

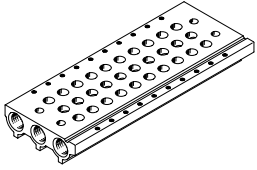

- For in-line valves M3, M5, M7, G1/8 and G1/4, width 10/14/18
- For 2x 3/2-way, 5/2-way and 5/3-way valves
- 2 to 10 and 12, 14, 16 valve positions

Manifold rail for sub-base valves

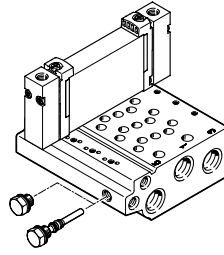

- For sub-base valves 10A, 10, 14 and 18, width 10/14/18
- Manifold rail with M3, M5/M7, G1/8 and G1/4 working ports
- For 2x 3/2-way, 5/2-way and 5/3-way valves
- 2 to 10, 12, 14 and 16 valve positions
- The sub-base valves always have external pneumatic spring supply. The pneumatic spring is supplied via the manifold rail. A short (for internal pneumatic spring supply) and long (for external pneumatic spring supply) blanking plug are included with the manifold rail for this purpose.

 **Note**

Duct 84 must not be sealed by a blanking plug when connecting a sub-base valve.

Cover plate for vacant position



For covering vacant valve positions

Supply plate



For additional air supply and exhaust via a valve position

Separator for pressure zones



For creating multiple pressure zones

Pilot pressure p2 as a function of operating pressure p1

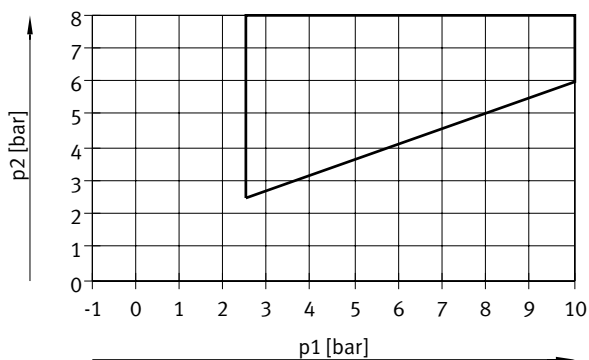

This graph applies to the 2x3/2-way valves and 5/2-way monostable valves with pneumatic spring:

- T32CA, T32UA, T32HA,
- M52A, M52R

 **Note**

The compressed air for the pneumatic springs is supplied from port 1 (operating pressure).

The minimum pressure as per the graph must always be adhered to for the pilot pressure to ensure the valve switches reliably.

Key features – Pneumatic components

Creating pressure zones and separating exhaust air

Compressed air is supplied and exhausted via the manifold rail and supply plates.

The position of the supply plates and duct separations can be freely selected with the VUWG.

Pressure zones are created by isolating the internal supply ducts between the manifold sub-bases by appropriate duct separation.

Pressure zone separation can be used for the following ducts:

- Duct 1
- Duct 3
- Duct 5

 **Note**

- Use separators if the exhaust air pressures are high
- Use at least one supply plate/air supply for each pressure zone

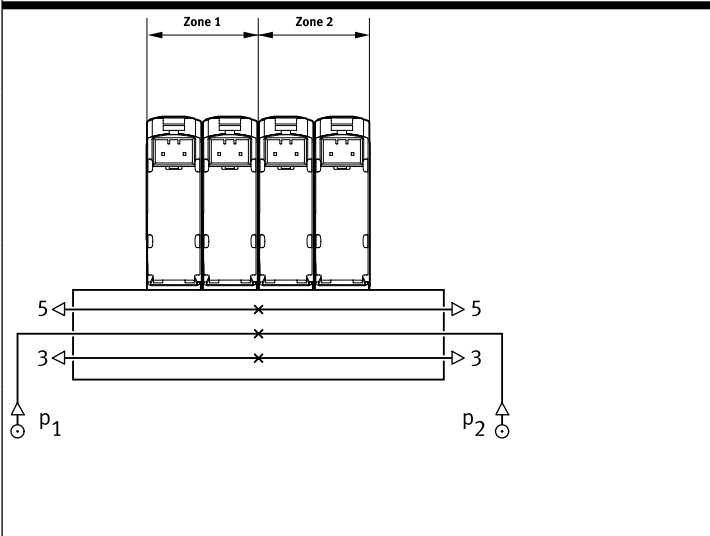
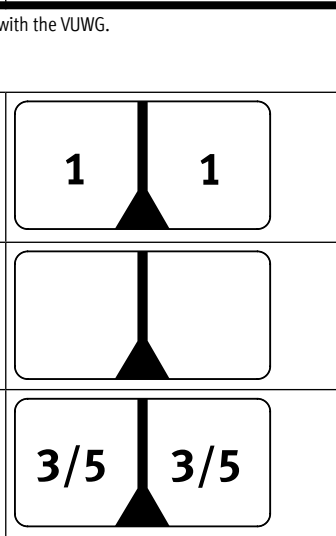
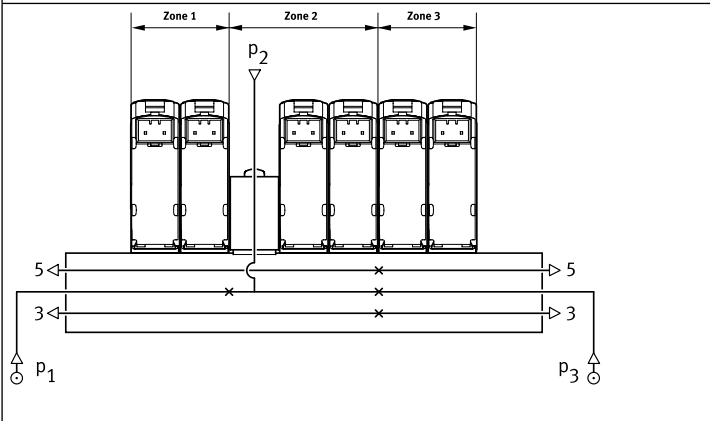
Duct separation	Description	Symbol
	<p>The pressure zones can be freely configured with the VUWG. The following duct separations are possible:</p> <ul style="list-style-type: none"> • Duct 1 closed • Duct 1/3/5 closed • Duct 3/5 closed 	
	<p>The number of pressure zones with the VUWG is only limited by the number of valve positions on the manifold rail. Note that each supply plate occupies one valve position.</p>	

Separator VABD

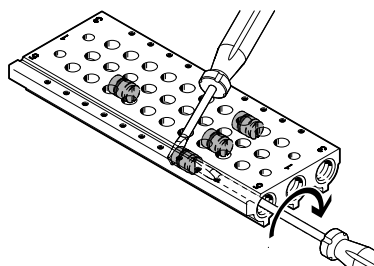

 **Note**

As the separators are fitted from only one side using a slotted screwdriver, several pressure zones can be created in one profile.

Key features – Pneumatic components

Flow restrictor

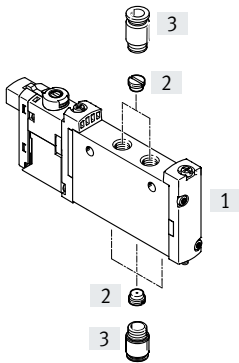

- [1] Valve
- [2] Flow control valve
- [3] Fitting

Flow control valve can be fitted in port 1, 3/5 and/or in port 2/4.

Operation with different pressures

Vacuum operation

The following points need to be observed with vacuum operation:

- M52 in-line valves with pneumatic spring and pneumatic/mechanical spring return (vacuum only at 3/5)
- T32 valves with pneumatic spring return (vacuum only at 3/5)

If external pilot air via duct 14 is used, M52 sub-base valves (B) can be used without restriction.

The remaining valve types can be used without restriction for vacuum.

Reverse operation

The valves with pneumatic spring are not suitable for reverse operation, since at least the minimum pilot pressure must be present in duct 1.

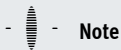

Note

Pressure must be present at port 1.

Pressure divider (internal pilot air)

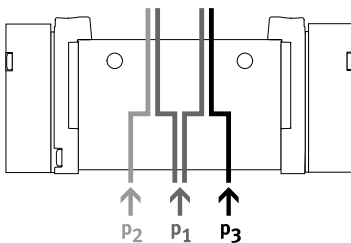

- If two different pressures are required.
- Different pressures can be supplied at duct 1, 3 and 5.



Note

- With internal pilot air, adhere to the minimum pilot pressure in duct 1
- With 2x 3/2-way valves without spring return, adhere to minimum pilot pressure in duct 1

Any pressure or vacuum can be connected at duct 3 and 5 both with external and internal pilot air.

Vacuum, ejector pulse and normal position

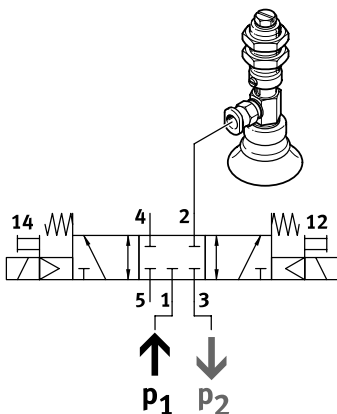

Vacuum, ejector pulse and normal position with internal pilot air can be realised by connecting vacuum at

duct 3 and pressure for the ejector pulse at duct 1.

Product range overview

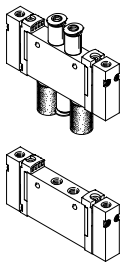
Design	Working port	Valve code	Functions and flow rate [l/min]											→ Page/ Internet	
			T32C	T32U	T32H	T32C/M	T32U/M	T32H/M	M52	M52/M	B52	P53C	P53U		P53E
In-line valve as individual valve, VUWG-L															
	M3	10A	–	–	–	–	–	–	■	■	■	■	■	■	13
	M5	10	■	■	■	■	■	■	■	■	■	■	■	■	17
	M7	10	■	■	■	■	■	■	■	■	■	■	■	■	17
	G1/8	14	■	■	■	■	■	■	■	■	■	■	■	■	26
	G1/4	18	■	■	■	■	■	■	■	■	■	■	■	■	32

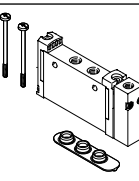
In-line valve for manifold assembly, VUWG-S															
	M3	10A	–	–	–	–	–	–	■	■	■	■	■	■	15
	M5	10	■	■	■	■	■	■	■	■	■	■	■	■	23
	M7	10	■	■	■	■	■	■	■	■	■	■	■	■	23
	G1/8	14	■	■	■	■	■	■	■	■	■	■	■	■	29
	G1/4	18	■	■	■	■	■	■	■	■	■	■	■	■	35

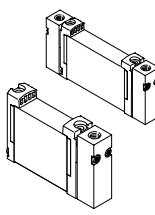
Design	Working port	Type code	Functions and flow rate [l/min]											→ Page/ Internet	
			T32C	T32U	T32H	T32C/M	T32U/M	T32H/M	M52	M52/M	B52	P53C	P53U		P53E
Sub-base valve, VUWG-B															
	–	10A	–	–	–	–	–	–	■	■	■	■	■	■	37
	–	10	■	■	■	■	■	■	■	■	■	■	■	■	41
	–	10	■	■	■	■	■	■	■	■	■	■	■	■	41
	–	14	■	■	■	■	■	■	■	■	■	■	■	■	45
	–	18	■	■	■	■	■	■	■	■	■	■	■	■	49

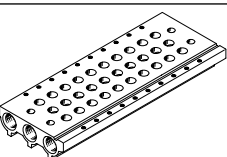
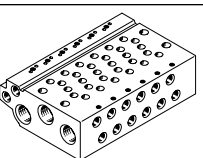
Design	Working port	Type code	Description	→ Page/ Internet
Manifold rail VABM- ... -S- ..., for in-line valves (manifold assembly)				
	–	–	Valve size M3, M5, M7, G1/8, G1/4	vabm
Manifold rail VABM, for sub-base valves				
	–	10AW	Connection size M3	vabm
	–	10W	Connection size M5	
	–	10HW	Connection size M7	
	–	14W	Connection size G1/8	
	–	18W	Connection size G1/4	

Overview of valve functions

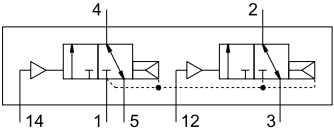
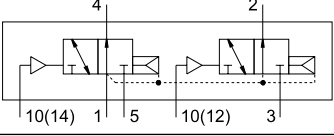
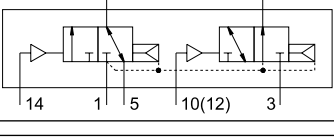
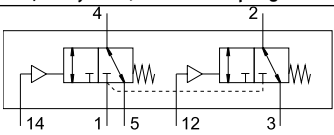
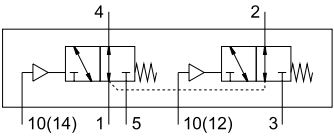
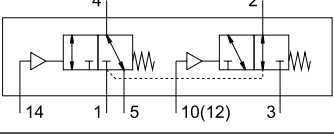
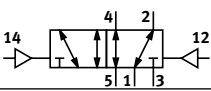
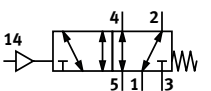
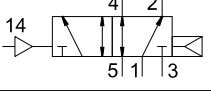
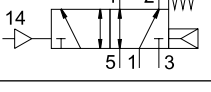
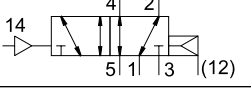
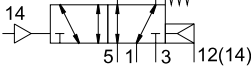
Valve	Valve code	Description	Valve terminal/ position function order code	Size			
				M3	M5/M7	G1/8	G1/4
2x 3/2-way valve, pneumatic spring							
	T32C-A	<ul style="list-style-type: none"> • Normally closed • Pneumatic spring return 	K	–	■	■	■
	T32U-A	<ul style="list-style-type: none"> • Normally open • Pneumatic spring return 	N	–	■	■	■
	T32H-A	<ul style="list-style-type: none"> • 1x normally open • 1x normally closed • Pneumatic spring return 	H	–	■	■	■
2x 3/2-way valve, mechanical spring							
	T32C-M	<ul style="list-style-type: none"> • Normally closed • Mechanical spring return 	VK	–	■	■	■
	T32U-M	<ul style="list-style-type: none"> • Normally open • Mechanical spring return 	VN	–	■	■	■
	T32H-M	<ul style="list-style-type: none"> • 1x normally open • 1x normally closed • Mechanical spring return 	VH	–	■	■	■
5/2-way valve, bistable							
	B52	–	J	■	■	■	■
5/2-way valve, monostable							
	M52-M	<ul style="list-style-type: none"> • Mechanical spring return 	A	■	■	■	■
	M52-A	<ul style="list-style-type: none"> • In-line valve • Pneumatic spring return 	M	–	–	■	–
	M52-R	<ul style="list-style-type: none"> • In-line valve • Pneumatic/mechanical spring return 	P	■	■	–	■
5/2-way monostable valve, sub-base valve							
	M52-A	<ul style="list-style-type: none"> • Pneumatic spring return 	M	–	–	■	–
	M52-R	<ul style="list-style-type: none"> • Pneumatic/mechanical spring return 	P	■	■	–	■

Overview of valve functions

Valve	Valve code	Description	Valve terminal/ position function order code	Size			
				M3	M5/M7	G1/8	G1/4
5/3-way valve							
	P53C	<ul style="list-style-type: none"> • Mid-position closed • Mechanical spring return 	G	■	■	■	■
	P53U	<ul style="list-style-type: none"> • Mid-position pressurised • Mechanical spring return 	B	■	■	■	■
	P53E	<ul style="list-style-type: none"> • Mid-position exhausted • Mechanical spring return 	E	■	■	■	■

Sample system overview – VUWG-L10 and VUWG-S10, in-line valves M5/M7

Manifold assembly

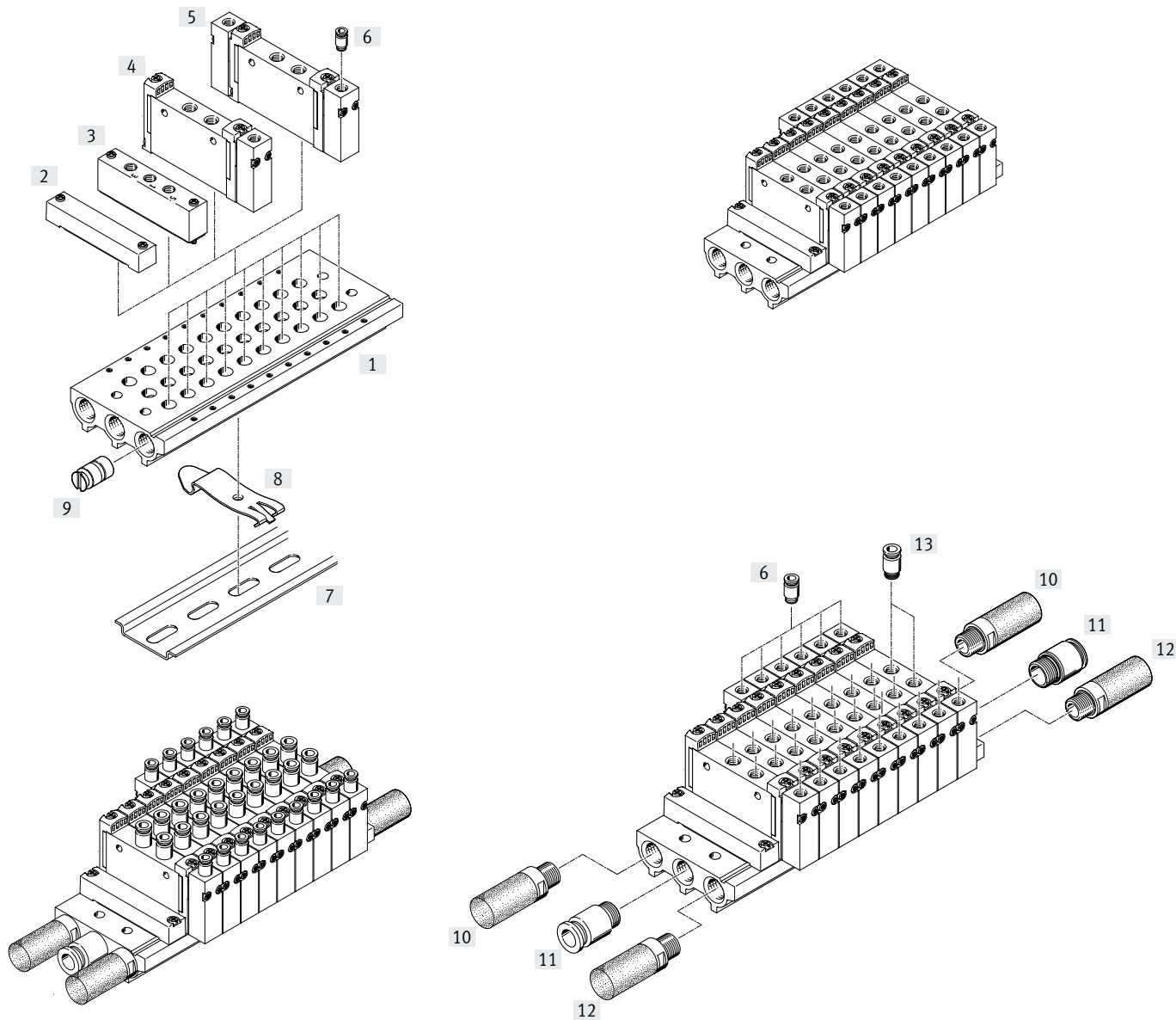

Manifold assembly and accessories

	Type	Brief description	→ Page/Internet	
[1]	Manifold rail	VABM-L1-10S-G18	For 2 to 10, 12, 14 and 16 valve positions	24
[2]	Cover plate	VABB-L1-10-S	For covering a vacant position	25
[3]	Supply plate	VABF-L1-10-P3A4	For air supply at port 1 and ports 3 and 5	25
[4]	Pneumatic valve	VUWG	Pneumatic valve, monostable	17
[5]	Pneumatic valve	VUWG	Pneumatic valve, bistable	17
[6]	Push-in fitting	QS	For adapter plate for port 12 or 14	53
[7]	DIN rail	NRH-35-2000	For mounting the valve manifold assembly	54
[8]	DIN rail mounting	VAME-T-M4	2 pieces for attaching the valve manifold to the DIN rail	54
[9]	Separator	VABD-8-B	For creating pressure zones	25
[10]	Silencer	U	For port 3	53
[11]	Push-in fitting	QS	For port 1	53
[12]	Silencer	U	For port 5	53
[13]	Push-in fitting	QS	For port 2 and 4	53

Sample system overview – VUWG-B10, sub-base valves

Manifold assembly

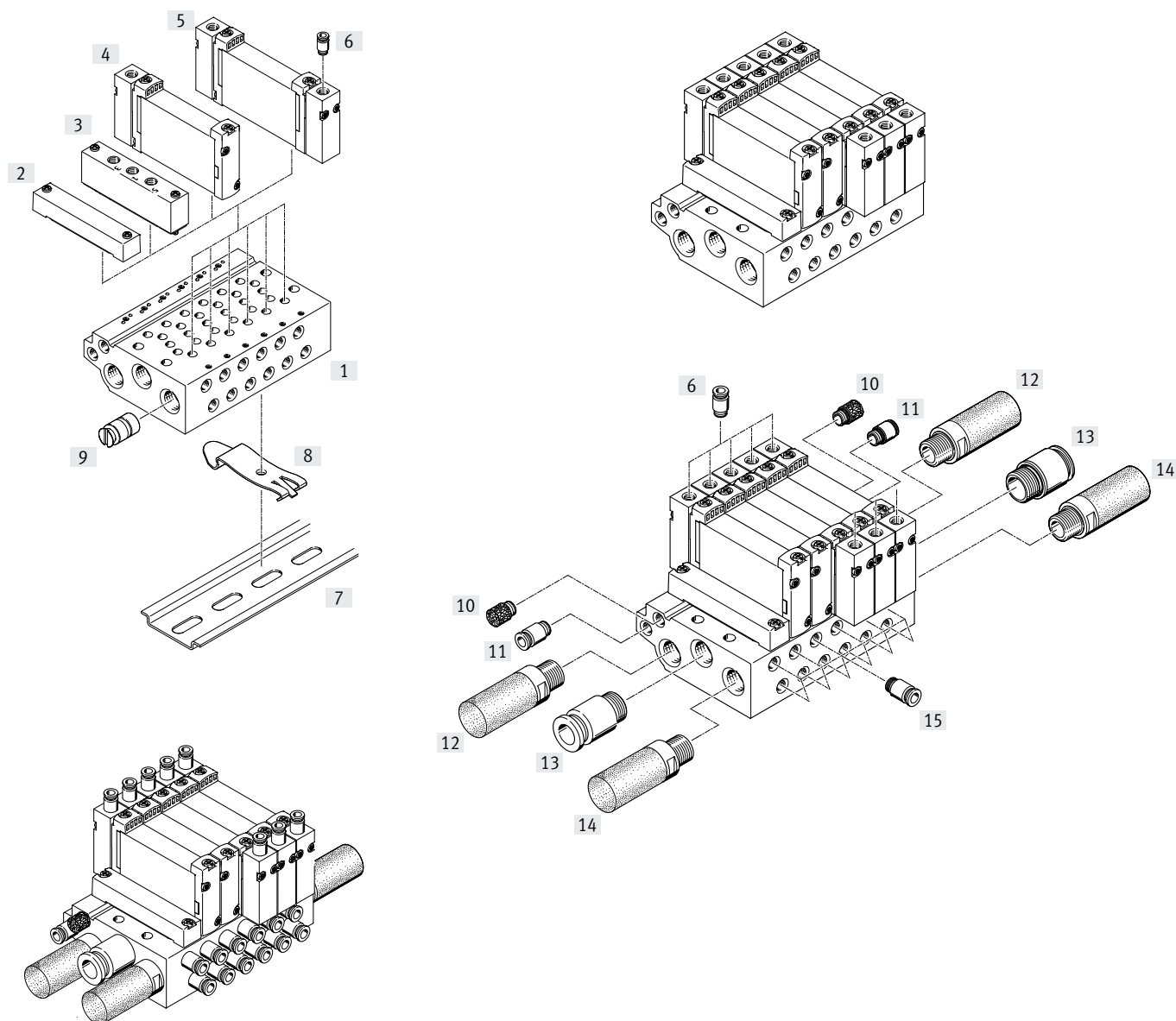

Manifold assembly and accessories

	Type	Brief description	→ Page/Internet
[1]	Manifold rail	VABM-L1-10W-G18	For 2 to 10, 12, 14 and 16 valve positions
[2]	Cover plate	VABB-L1-10-W	For covering a vacant position
[3]	Supply plate	VABF-L1-10-P3A4-M5	For air supply at port 1 and ports 3 and 5
[4]	Pneumatic valve	VUWG	Pneumatic valve, monostable
[5]	Pneumatic valve	VUWG	Pneumatic valve, bistable
[6]	Push-in fitting	QS	For adapter plate for port 12 or 14
[7]	DIN rail	NRH-35-2000	For mounting the valve manifold assembly
[8]	DIN rail mounting	VAME-T-M4	2 pieces for attaching the valve manifold to the DIN rail
[9]	Separator	VABD-6-B	For creating pressure zones
[10]	Silencer	U	For port 84
[11]	Push-in fitting	QS	For port 14
[12]	Silencer	U	For port 5
[13]	Push-in fitting	QS	For port 1
[14]	Silencer	U	For port 3
[15]	Push-in fitting	QS	For port 2 and 4

Type codes – Pneumatic valves VUWG

001	Series	
VUWG	Pneumatic valve	

002	Directional control valve type	
L	In-line valve	
S	Semi-inline valve	
B	Sub-base valve	

003	Size	
10A	Size 10, deviating flow	
10	Size 10	
14	Size 14	
18	Size 18	

004	Valve function	
T32U	2x3/2-way valve, normally open	
T32C	2x3/2-way valve, normally closed	
T32H	2x3/2-way valve, 1x normally closed, 1x normally open	
M52	5/2-way valve, monostable	
B52	5/2-way valve, bistable	
P53U	5/3-way valve, mid-position pressurised	
P53E	5/3-way valve, mid-position exhausted	
P53C	5/3-way valve, mid-position closed	

005	Reset method for monostable/single solenoid valves	
	None	
A	Pneumatic spring	
E	Pneumatic spring, external	
M	Mechanical spring	
R	Mixed, pneumatic/mechanical spring	
X	Mixed, pneumatic/mechanical spring, external	

006	Pneumatic connection	
F	Flange/sub-base	
M3	M3	
M5	M5	
M7	M7	
G18	G1/8	
G14	G1/4	
Q3	Push-in connector 3 mm	
Q4	Push-in connector 4 mm	
Q4H	Push-in connector 4 mm, with connecting thread M7	
Q6	Push-in connector 6 mm	
Q6H	Push-in connector 6 mm, with connecting thread M7	
Q8	Push-in connector 8 mm	
Q10	Push-in connector 10 mm	
T18	Push-in connector 1/8"	
T532	Push-in connector 5/32"	
T316	Push-in connector 3/16"	
T316H	Push-in connector for 3/16", M7	
T14	Push-in connector 1/4"	
T14H	Push-in connector for 1/4", M7	
T38	Push-in connector 3/8"	
T516	Push-in connector 5/16"	

007	Exhaust	
	No fitting	
QN	With fitting	
U	Silencer	

Datasheet

Function
 5/2-way, monostable
 5/2-way, bistable
 5/3C, 5/3U, 5/3E

-  - Width 10 mm

-  - Flow rate
 80 ... 100 l/min



General technical data						
Valve function	M52-R	B52	M52-M	P53		
Normal position	–	–	–	C ¹⁾	U ²⁾	E ³⁾
Pneumatic spring return	Yes ⁴⁾	–	No	No		
Mechanical spring return	Yes ⁴⁾	–	Yes	Yes		
Vacuum operation at port 1	No	Yes	Yes	Yes		
Vacuum operation at port 3/5	Yes					
Design	Piston spool					
Overlap	Positive overlap				Indeterminate overlap	
Sealing principle	Soft					
Actuation type	Pneumatic					
Type of control	Direct					
Flow direction	Reversible with restrictions	Reversible	Reversible	Reversible	Reversible	Reversible
Exhaust air function	Can be throttled					
Type of mounting	Optionally via through-holes ⁶⁾ or on manifold rail					
Mounting position	Any					
Standard nominal flow rate	[l/min]	100	80	90		
Switching time on/off	[ms]	5/11	–	5/16	7/19	
Switching time changeover	[ms]	–	5	–	9	
Width	[mm]	10				
Connection	1, 2, 3, 4, 5	M3				
	12, 14	M5				
Product weight	[g]	37	40	34	40	
Corrosion resistance class CRC ⁵⁾	2					

- 1) C = Normally closed
- 2) U = Normally open/mid-position pressurised
- 3) E = Normally exhausted
- 4) Combined reset method
- 5) Corrosion resistance class CRC 2 to Festo standard FN 940070
 Moderate corrosion stress. Indoor applications in which condensation can occur. External visible parts with primarily decorative surface requirements that are in direct contact with a normal industrial environment.
- 6) If several valves are to be screwed together via the through-holes to form a block, a minimum distance of 0.3 mm must be ensured by inserting spacers.

Operating and environmental conditions					
Valve function	M52-R ³⁾	B52	M52-M ²⁾	P53	
Operating medium	Compressed air to ISO 8573-1:2010 [7:4:4]				
Note on the operating/pilot medium	Lubricated operation possible (in which case lubricated operation will always be required)				
Operating pressure	[bar]	2.5 ... 10	–0.9 ... 10	–0.9 ... 8	–0.9 ... 10
Pilot pressure ¹⁾	[bar]	2.5 ... 10	1.5 ... 10	3 ... 10	
Ambient temperature	[°C]	–5 ... +60			
Temperature of medium	[°C]	–5 ... +50			
Cleanroom class	ISO class 5				

- 1) Note operating pressure/pilot pressure graph → page 4
- 2) Mechanical spring
- 3) Mixed, pneumatic/mechanical spring

Datasheet

Information on materials	
Housing	Anodised aluminium
Seals	HNBR, NBR
Note on materials	RoHS-compliant

Dimensions Download CAD data → www.festo.com

5/2- and 5/3-way valves

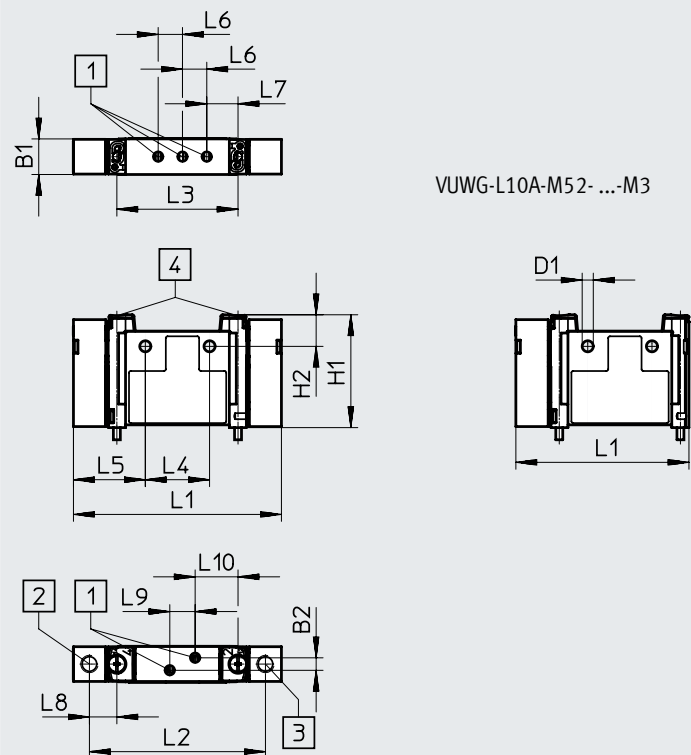

- [1] Ports 1, 2, 3, 4, 5: M3 [2] Port 14: M5 [3] Port 12: M5 [4] Retaining screw M2.5

Type	B1	B2	D1 ø	H1	H2	L1	L2	L3	L4	L5	L6	L7	L8	L9	L10
VUWG-L10A-...	10.3	3.6	3.2	32.5	9.1	59.9	50.7	34.9	18.5	20.7	7	9	7.9	7.3	12.4
VUWG-L10A-M52-...						49.9									

Ordering data			
	Description	Part no.	Type
In-line valve M3			
	5/2-way valve, monostable		
	Pneumatic/mechanical spring return, internal pneumatic spring supply	573795	VUWG-L10A-M52-R-M3
	Mechanical spring return	574250	VUWG-L10A-M52-M-M3
	5/2-way valve, bistable		
	–	573796	VUWG-L10A-B52-M3
	5/3-way valve		
	Mid-position closed, mechanical spring return	573797	VUWG-L10A-P53C-M3
	Mid-position exhausted, mechanical spring return	573798	VUWG-L10A-P53E-M3
	Mid-position pressurised, mechanical spring return	573799	VUWG-L10A-P53U-M3

Manifold assembly

In-line valves for manifold assembly

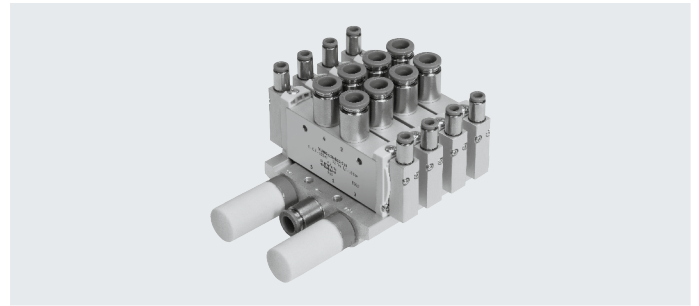

Dimensions

Download CAD data → www.festo.com

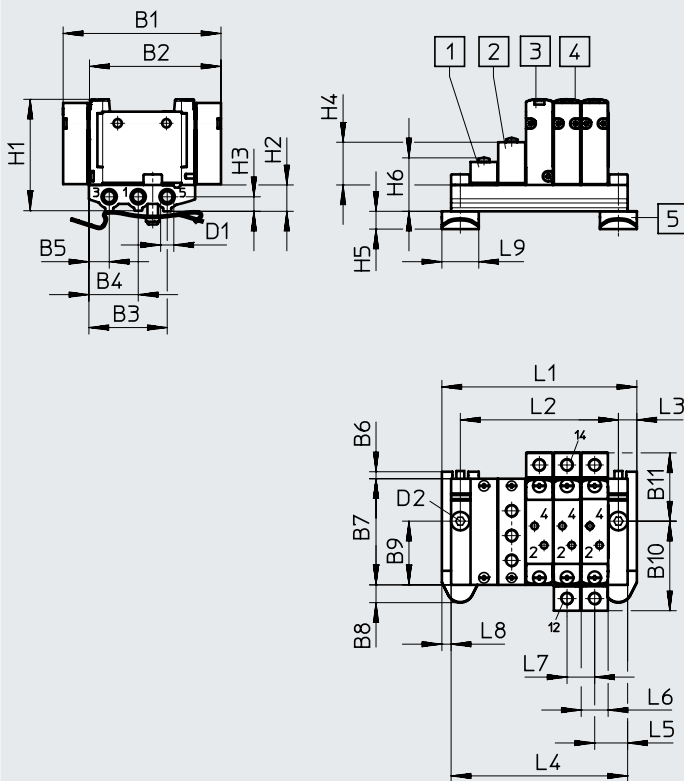

- [1] Cover plate
VABB-L1-10A-S
- [2] Supply plate
VABF-L1-10A-P3A4-M5
- [3] Pneumatic valve, monostable
- [4] Pneumatic valve, bistable
- [5] DIN rail mounting (two M4x15 screws to DIN 912 are required for mounting)

Type	B1	B2	B3	B4	B5	B6	B7	B8	B9	B10	B11	D1
VABM-L1-10AS-M5	59.9	49.9	29.7	18.7	7.7	2.95	40.3	6.75	24.2	34	25.9	M5

Type	D2	H1	H2	H3	H4	H5	H6	L3	L5	L6	L7	L8	L9
VABM-L1-10AS-M5	∅ 4.5	42.5	10	5.5	16.2	6.8	20.3	7	12.5	10.3	10.5	3.5	14

Valve positions	2	3	4	5	6	7	8	9	10	12	14	16
L1 [mm]	42.5	53	63.5	74	84.5	95	105.5	116	126.5	147.5	168.5	189.5
L2 [mm]	28.5	39	49.5	60	70.5	81	91.5	102	112.5	133.5	154.5	175.5
L4 [mm]	35.5	46	56.5	67	77.5	88	98.5	109	119.5	140.5	161.5	182.5



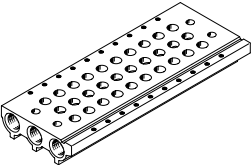

Ordering data

Technical data – Manifold rails							
	Connection 1, 3, 5	CRC ¹⁾	Material ²⁾	Operating pressure [bar]	Max. tightening torque for assembly [Nm]		
					Valve	DIN rail	Wall
	M5	2	Wrought aluminium alloy	-0.9 ... 10	0.45	1.5	3

1) Corrosion resistance class CRC 2 to Festo standard FN 940070

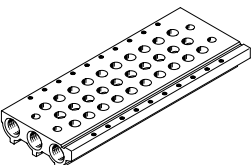
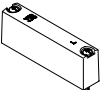

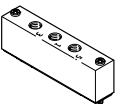
Moderate corrosion stress. Indoor applications in which condensation can occur. External visible parts with primarily decorative surface requirements that are in direct contact with a normal industrial environment.

2) Information on materials: RoHS-compliant

Ordering data – Accessories				
	Description		Part no.	Type
Manifold rail for in-line valves (manifold assembly)				
	For valve size M3	2 valve positions	566522	VABM-L1-10AS-M5-2
		3 valve positions	566523	VABM-L1-10AS-M5-3
		4 valve positions	566524	VABM-L1-10AS-M5-4
		5 valve positions	566525	VABM-L1-10AS-M5-5
		6 valve positions	566526	VABM-L1-10AS-M5-6
		7 valve positions	566527	VABM-L1-10AS-M5-7
		8 valve positions	566528	VABM-L1-10AS-M5-8
		9 valve positions	566529	VABM-L1-10AS-M5-9
		10 valve positions	566530	VABM-L1-10AS-M5-10
		12 valve positions	566531	VABM-L1-10AS-M5-12
14 valve positions	566532	VABM-L1-10AS-M5-14		
16 valve positions	566533	VABM-L1-10AS-M5-16		
Cover plate Datasheets → Internet: vabb				
	For manifold rail for M3 in-line valves	including screws and seal	569986	VABB-L1-10A
Separator Datasheets → Internet: vabd				
	For manifold rail for M3 in-line valves	Separator for pressure zones	570872	VABD-4.2-B
Supply plate Datasheets → Internet: vabf				
	For manifold rail for M3 in-line valves	including screws and seal	569990	VABF-L1-10A-P3A4-M5
Seals for in-line valves Datasheets → Internet: vabd				
	M3	Delivery quantity: 10 sets (each with 2 screws and 1 seal)	566670	VABD-L1-10AX-S-M3

Datasheet

Function
 2x3/2C, 2x3/2U, 2x3/2H
 5/2-way, monostable
 5/2-way, bistable
 5/3C, 5/3U, 5/3E

 - Width 10 mm
 - Flow rate
 125 ... 220 l/min



General technical data												
Valve function	T32-A			T32-M			M52-R	B52	M52-M	P53		
Normal position	C ¹⁾	U ²⁾	H ⁴⁾	C ¹⁾	U ²⁾	H ⁴⁾	-	-	-	C ¹⁾	U ²⁾	E ³⁾
Pneumatic spring return	Yes			No			Yes ⁵⁾	-	No	No		
Mechanical spring return	No			Yes			Yes ⁵⁾	-	Yes	Yes		
Vacuum operation at port 1	No			Yes			No	Yes				
Vacuum operation at port 3/5	Yes											
Design	Piston spool											
Overlap	Positive overlap										Indeterminate overlap	
Sealing principle	Soft											
Actuation type	Pneumatic											
Type of control	Direct											
Flow direction	Reversible with restrictions			Reversible			Reversible with restrictions	Reversible	Reversible	Reversible		
Exhaust air function	Can be throttled											
Type of mounting	Optionally via through-holes ⁷⁾ or on manifold rail											
Mounting position	Any											
Standard nominal flow rate	[l/min]			150	135	125	220		190	210		
Switching time on/off	[ms]			4/9		6/7		6/12	-	7/16		8/25
Switching time changeover	[ms]			-			5		-	11		
Width	[mm]			10								
Connection	1, 2, 3, 4, 5			M5								
	12, 14			M5								
Product weight	[g]			48		51		45	48	41	48	
Corrosion resistance class CRC ⁶⁾	2											

1) C = Normally closed

2) U=Normally open/mid-position pressurised

3) E = Normally exhausted

4) H=2x 3/2-way valve in one housing with 1x normally closed and 1x normally open

5) Combined reset method

6) Corrosion resistance class CRC 2 to Festo standard FN 940070

Moderate corrosion stress. Indoor applications in which condensation can occur. External visible parts with primarily decorative surface requirements that are in direct contact with a normal industrial environment.

7) If several valves are to be screwed together via the through-holes to form a block, a minimum distance of 0.3 mm must be ensured by inserting spacers.

Datasheet

Operating and environmental conditions							
Valve function		T32-A ²⁾	T32-M ³⁾	M52-R ⁴⁾	B52	M52-M ³⁾	P53
Operating medium	Compressed air to ISO 8573-1:2010 [7:4:4]						
Note on the operating/pilot medium	Lubricated operation possible (in which case lubricated operation will always be required)						
Operating pressure	[bar]	1.5 ... 10	-0.9 ... 10	2.5 ... 10	-0.9 ... 10	-0.9 ... 8	-0.9 ... 10
Pilot pressure ¹⁾	[bar]	1.5 ... 10	3 ... 10	2.5 ... 10	1.5 ... 10	3 ... 10	
Ambient temperature	[°C]	-5 ... +60					
Temperature of medium	[°C]	-5 ... +50					
Cleanroom class	ISO class 5						

1) Note operating pressure/pilot pressure graph → page 4

2) Pneumatic spring

3) Mechanical spring

4) Mixed, pneumatic/mechanical spring

Information on materials	
Housing	Wrought aluminium alloy
Seals	HNBR, NBR
Note on materials	RoHS-compliant

Dimensions

Download CAD data → www.festo.com

2x3/2-way, 5/2-way and 5/3-way valve

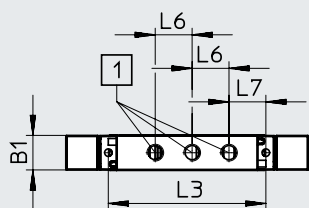

VUWG-L10-M52-....

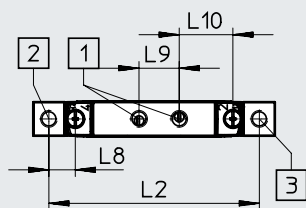
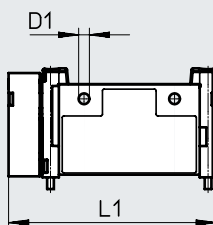
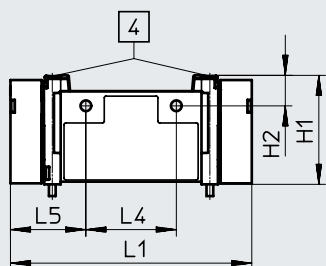

[1] Port 1, 2, 3, 4, 5: M5

[2] Port 14: M5

[4] Retaining screw M2.5

[3] Port 12: M5

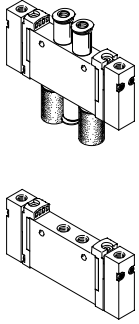

Type	B1	D1 ø	H1	H2	L1	L2	L3	L4	L5	L6	L7	L8	L9	L10
VUWG-L10-...	10.2	3.2	32.5	9.1	72	62.8	47	27	22.5	11	11	7.9	12	16
VUWG-L10-M52-...					62									

Ordering data

Ordering data	Description	Part no.	Type
In-line valve M5			
	2x3/2-way valve		
	Normally closed, pneumatic spring return, internal pneumatic spring supply	573805	VUWG-L10-T32C-A-M5
	Normally open, pneumatic spring return, internal pneumatic spring supply	573806	VUWG-L10-T32U-A-M5
	1x normally open, 1x normally closed, Pneumatic spring return, Internal pneumatic spring supply	573807	VUWG-L10-T32H-A-M5
	Normally closed, mechanical spring return	574251	VUWG-L10-T32C-M-M5
	Normally open, mechanical spring return	574252	VUWG-L10-T32U-M-M5
	1x normally open, 1x normally closed, mechanical spring return	574253	VUWG-L10-T32H-M-M5
	5/2-way valve, monostable		
	Pneumatic/mechanical spring return, internal pneumatic spring supply	573808	VUWG-L10-M52-R-M5
	Mechanical spring return	574254	VUWG-L10-M52-M-M5
	5/2-way valve, bistable		
	–	573809	VUWG-L10-B52-M5
	5/3-way valve		
	Mid-position closed, mechanical spring return	573810	VUWG-L10-P53C-M5
Mid-position exhausted, mechanical spring return	573811	VUWG-L10-P53E-M5	
Mid-position pressurised, mechanical spring return	573812	VUWG-L10-P53U-M5	

Datasheet

Function
 2x3/2C, 2x3/2U, 2x3/2H
 5/2-way, monostable
 5/2-way, bistable
 5/3C, 5/3U, 5/3E

 Width 10 mm
 Flow rate
 140 ... 380 l/min



General technical data

Valve function	T32-A			T32-M			M52-R	B52	M52-M	P53		
Normal position	C ¹⁾	U ²⁾	H ⁴⁾	C ¹⁾	U ²⁾	H ⁴⁾	–	–	–	C ¹⁾	U ²⁾	E ³⁾
Pneumatic spring return	Yes			No			Yes ⁵⁾	–	No	No		
Mechanical spring return	No			Yes			Yes ⁵⁾	–	Yes	Yes		
Vacuum operation at port 1	No			Yes			No	Yes				
Vacuum operation at port 3/5	Yes											
Design	Piston spool											
Overlap	Positive overlap										Indeterminate overlap	
Sealing principle	Soft											
Actuation type	Pneumatic											
Type of control	Direct											
Flow direction	Reversible with restrictions			Reversible			Reversible with restrictions		Reversible	Reversible	Reversible	
Exhaust air function	Can be throttled											
Type of mounting	Optionally via through-holes ⁷⁾ or on manifold rail											
Mounting position	Any											
Standard nominal flow rate	[l/min]	190			150	140	380			320		
Switching time on/off	[ms]	4/9			6/7			6/12		–	7/16	8/25
Switching time changeover	[ms]	–										
Width	[mm]	10										
Connection	1, 2, 3, 4, 5	M7										
	12, 14	M5										
Product weight	[g]	48			51			45	48	41	48	
Corrosion resistance class CRC ⁶⁾	2											

1) C = Normally closed

2) U = Normally open/mid-position pressurised

3) E = Normally exhausted

4) H = 2x 3/2-way valve in one housing with 1x normally closed and 1x normally open

5) Combined reset method

6) Corrosion resistance class CRC 2 to Festo standard FN 940070

Moderate corrosion stress. Indoor applications in which condensation can occur. External visible parts with primarily decorative surface requirements that are in direct contact with a normal industrial environment.

7) If several valves are to be screwed together via the through-holes to form a block, a minimum distance of 0.3 mm must be ensured by inserting spacers.

Datasheet

Operating and environmental conditions						
Valve function	T32-A ²⁾	T32-M ³⁾	M52-R ⁴⁾	B52	M52-M ³⁾	P53
Operating medium	Compressed air to ISO 8573-1:2010 [7:4:4]					
Note on the operating/pilot medium	Lubricated operation possible (in which case lubricated operation will always be required)					
Operating pressure	[bar]	1.5 ... 10	-0.9 ... 10	2.5 ... 10	-0.9 ... 10	-0.9 ... 8
Pilot pressure ¹⁾	[bar]	1.5 ... 10	3 ... 10	2.5 ... 10	1.5 ... 10	3 ... 10
Ambient temperature	[°C]	-5 ... +60				
Temperature of medium	[°C]	-5 ... +50				
Cleanroom class	ISO class 5					

- 1) Note operating pressure/pilot pressure graph → page 4
- 2) Pneumatic spring
- 3) Mechanical spring
- 4) Mixed, pneumatic/mechanical spring

Information on materials	
Housing	Wrought aluminium alloy
Seals	HNBR, NBR
Note on materials	RoHS-compliant

Dimensions

Download CAD data → www.festo.com

2x3/2-way, 5/2-way and 5/3-way valve

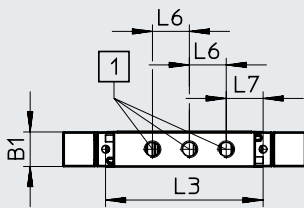

VUWG-L10-M52-....

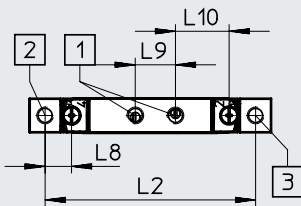
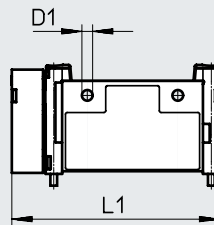
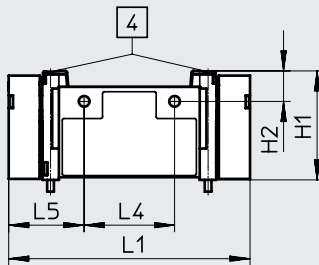

- [1] Port 1, 2, 3, 4, 5: M7
- [2] Port 14: M5
- [4] Retaining screw M2.5
- [3] Port 12: M5

Type	B1	D1 ø	H1	H2	L1	L2	L3	L4	L5	L6	L7	L8	L9	L10
VUWG-L10-...	10.2	3.2	32.5	9.1	72	62.8	47	27	22.5	11	11	7.9	12	16
VUWG-L10-M52-...					62									

Ordering data

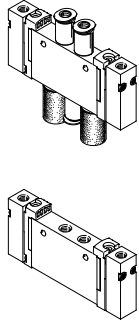
Ordering data	Description	Part no.	Type
In-line valve M7			
	2x3/2-way valve		
	Normally closed, pneumatic spring return, internal pneumatic spring supply	573821	VUWG-L10-T32C-A-M7
	Normally open, pneumatic spring return, internal pneumatic spring supply	573822	VUWG-L10-T32U-A-M7
	1x normally open, 1x normally closed, pneumatic spring return, internal pneumatic spring supply	573823	VUWG-L10-T32H-A-M7
	Normally closed, mechanical spring return	574255	VUWG-L10-T32C-M-M7
	Normally open, mechanical spring return	574256	VUWG-L10-T32U-M-M7
	1x normally open, 1x normally closed, mechanical spring return	574257	VUWG-L10-T32H-M-M7
	5/2-way valve, monostable		
	Pneumatic/mechanical spring return, internal pneumatic spring supply	573824	VUWG-L10-M52-R-M7
	Mechanical spring return	574258	VUWG-L10-M52-M-M7
	5/2-way valve, bistable		
	–	573825	VUWG-L10-B52-M7
	5/3-way valve		
	Mid-position closed, mechanical spring return	573826	VUWG-L10-P53C-M7
	Mid-position exhausted, mechanical spring return	573827	VUWG-L10-P53E-M7
	Mid-position pressurised, mechanical spring return	573828	VUWG-L10-P53U-M7

Manifold assembly

In-line valves for manifold assembly

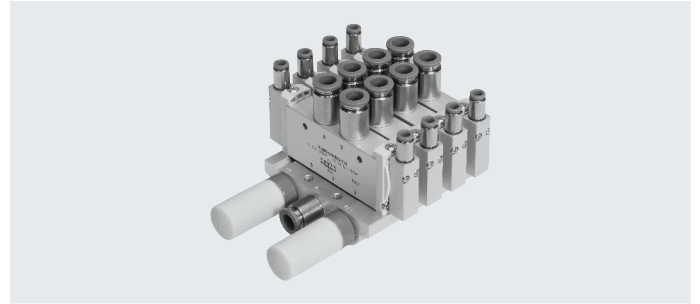

Dimensions

Download CAD data → www.festo.com

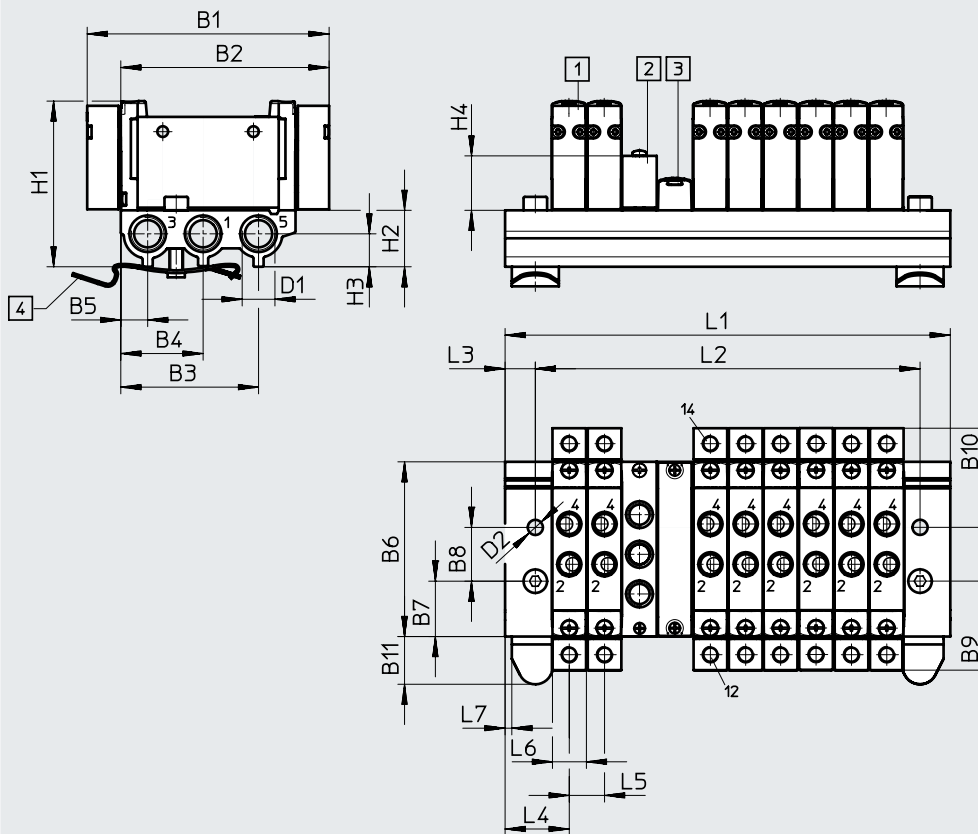

- [1] Pneumatic valve
- [2] Supply plate M5 or M7 for 1, 3, 5
- [3] Cover plate VABB-L1-10-S
- [4] DIN rail mounting (two M4x20 screws to DIN 912 are required)

Type	B1	B2	B3	B4	B5	B6	B7	B8	B9	B10	B11
VABM-L1-10S-G18	72	62	41	24.5	8	52	16.5	16	26.5	29.5	14.45

Type	D1	D2	H1	H2	H3	H4	H4	L3	L4	L5	L6	L7
VABM-L1-10S-G18	G1/8	4.5	49.3	16.8	7	16.2	16.2	9	19	10.5	10.3	2

Valve positions	2	3	4	5	6	7	8	9	10	12	14	16	22
L1 [mm]	48.5	59	69.5	80	90.5	101	111.5	122	132.5	153.5	174.5	195.5	258.5
L2 [mm]	30.5	41	51.5	62	72.5	83	93.5	104	114.5	135.5	156.5	177.5	240.5



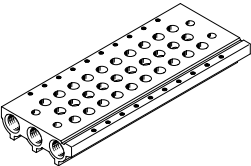

Ordering data

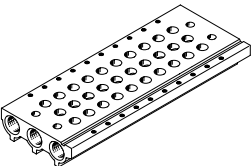
Technical data – Manifold rails	Connection 1, 3, 5	CRC ¹⁾	Material ²⁾	Operating pressure [bar]	Max. tightening torque for assembly [Nm]		
					Valve	DIN rail	Wall
	G1/8	2	Wrought aluminium alloy	-0.9 ... 10	0.45	1.5	3

- 1) Corrosion resistance class CRC 2 to Festo standard FN 940070
Moderate corrosion stress. Indoor applications in which condensation can occur. External visible parts with primarily decorative surface requirements that are in direct contact with a normal industrial environment.
- 2) Information on materials: RoHS-compliant

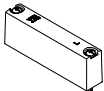

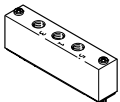
Ordering data – Manifold rail			
	Description	Part no.	Type
Manifold rail for in-line valve (manifold assembly)			
	For valve size M5/M7	2 valve positions	566558 VABM-L1-10S-G18-2
		3 valve positions	566559 VABM-L1-10S-G18-3
		4 valve positions	566560 VABM-L1-10SG18-4
		5 valve positions	566561 VABM-L1-10S-G18-5
		6 valve positions	566562 VABM-L1-10S-G18-6
		7 valve positions	566563 VABM-L1-10S-G18-7
		8 valve positions	566564 VABM-L1-10S-G18-8
		9 valve positions	566565 VABM-L1-10S-G18-9
		10 valve positions	566566 VABM-L1-10S-G18-10
		12 valve positions	566567 VABM-L1-10S-G18-12
14 valve positions	566568 VABM-L1-10S-G18-14		
16 valve positions	566569 VABM-L1-10S-G18-16		

Ordering data

Ordering data – Accessories			
	Description	Part no.	Type
Cover plate Datasheets → Internet: vabb			
	For manifold rail for M5/M7 in-line valves	including screws and seal	566462 VABB-L1-10-S
Separator Datasheets → Internet: vabd			
	For manifold rail for M5/M7 in-line valves	Separator for pressure zones	569995 VABD-8-B
Supply plate Datasheets → Internet: vabf			
	For manifold rail for M5 in-line valves	including screws and seal	569991 VABF-L1-10-P3A4-M5
	For manifold rail for M7 in-line valves		569992 VABF-L1-10-P3A4-M7
Seals for in-line valves Datasheets → Internet: vabd			
	M5	Delivery quantity: 10 sets (each with 2 screws and 1 seal)	566672 VABD-L1-10X-S-M5
	M7		566673 VABD-L1-10X-S-M7

Datasheet

Function
 2x3/2C, 2x3/2U, 2x3/2H
 5/2-way, monostable
 5/2-way, bistable
 5/3C, 5/3U, 5/3E

 - Width 14 mm
 - Flow rate
 500 ... 780 l/min

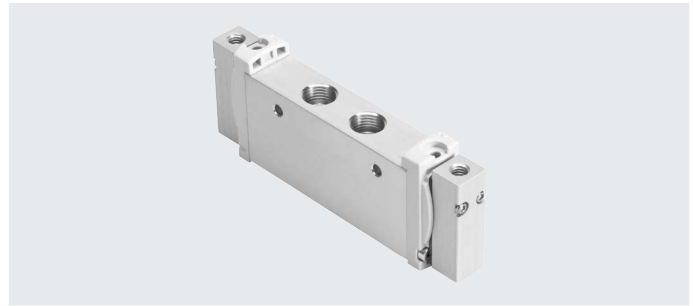

General technical data													
Valve function	T32-A			T32-M			M52-A	B52	M52-M	P53			
Normal position	C ¹⁾	U ²⁾	H ⁴⁾	C ¹⁾	U ²⁾	H ⁴⁾	–	–	–	C ¹⁾	U ²⁾	E ³⁾	
Pneumatic spring return	Yes			No			Yes	–	No	No			
Mechanical spring return	No			Yes			No	–	Yes	Yes			
Vacuum operation at port 1	No			Yes			No	Yes					
Vacuum operation at port 3/5	Yes												
Design	Piston spool												
Overlap	Positive overlap												
Sealing principle	Soft												
Actuation type	Pneumatic												
Type of control	Direct												
Flow direction	Reversible with restrictions			Reversible			Reversible with restrictions	Reversible	Reversible	Reversible			
Exhaust air function	Can be throttled												
Type of mounting	Optionally via through-holes ⁶⁾ or on manifold rail												
Mounting position	Any												
Standard nominal flow rate	[l/min]	650	600	650	550	500	780			650	600		
Switching time on/off	[ms]	6/19			9/13			1 2/22		–	1 2/32		8/30
Switching time changeover	[ms]	–											
Width	[mm]	14											
Connection	1, 2, 3, 4, 5	G1/8											
	12, 14	M5											
Product weight	[g]	81			77			75	81	67	81		
Corrosion resistance class CRC ⁵⁾	2												

1) C = Normally closed

2) U = Normally open/mid-position pressurised

3) E = Normally exhausted

4) H = 2x 3/2-way valve in one housing with 1x normally closed and 1x normally open

5) Corrosion resistance class CRC 2 to Festo standard FN 940070

Moderate corrosion stress. Indoor applications in which condensation can occur. External visible parts with primarily decorative surface requirements that are in direct contact with a normal industrial environment.

6) If several valves are to be screwed together via the through-holes to form a block, a minimum distance of 0.3 mm must be ensured by inserting spacers.

Datasheet

Operating and environmental conditions						
Valve function		T32-A ²⁾	T32-M ³⁾	M52-A ²⁾	B52	M52-M ³⁾ P53
Operating medium	Compressed air to ISO 8573-1:2010 [7:4:4]					
Note on the operating/pilot medium	Lubricated operation possible (in which case lubricated operation will always be required)					
Operating pressure	[bar]	1.5 ... 10	-0.9 ... 10	2.5 ... 10	-0.9 ... 10	-0.9 ... 10
Pilot pressure ¹⁾	[bar]	1.5 ... 10	3 ... 10	2.5 ... 10	1.5 ... 10	3 ... 10
Ambient temperature	[°C]	-5 ... +60				
Temperature of medium	[°C]	-5 ... +50				
Cleanroom class	ISO class 5					

- 1) Note operating pressure/pilot pressure graph → page 4
- 2) Pneumatic spring
- 3) Mechanical spring

Information on materials	
Housing	Wrought aluminium alloy
Seals	HNBR, NBR
Note on materials	RoHS-compliant

Dimensions Download CAD data → www.festo.com

2x3/2-way, 5/2-way and 5/3-way valve

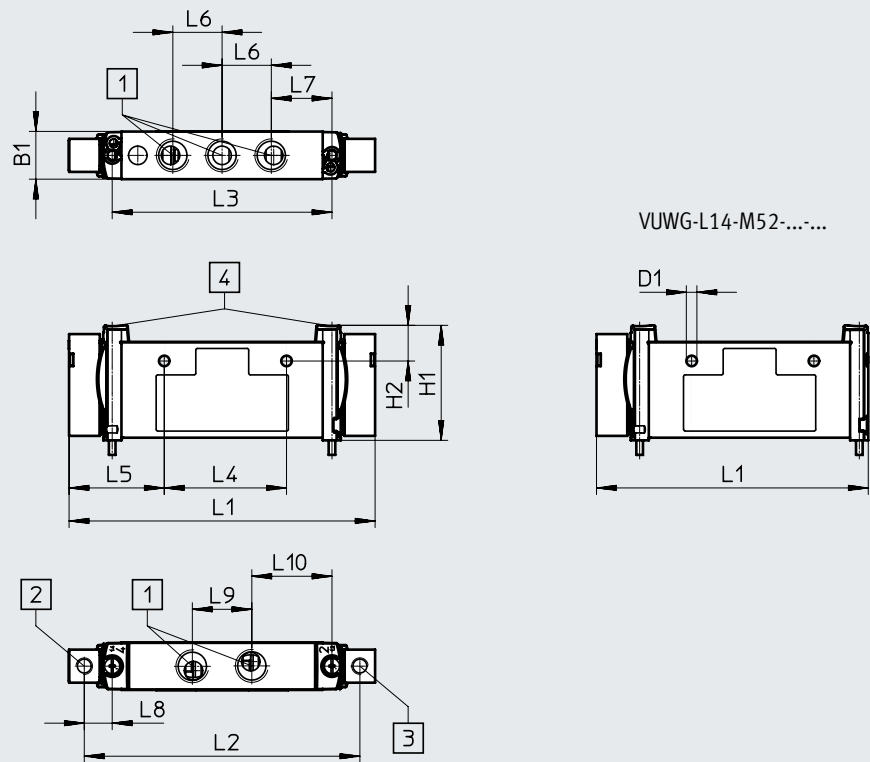

- [1] Ports 1, 2, 3, 4, 5: G1/8
- [2] Port 14: M5
- [3] Port 12: M5
- [4] Retaining screw M2.5

Type	B1	D1 ø	H1	H2	L1	L2	L3	L4	L5	L6	L7	L8	L9	L10
VUWG-L14-...	14.4	3.2	34.8	10.8	92.6	83.4	66.5	37	28.8	14.9	18.35	8.45	18	24.25
VUWG-L14-M52-...					82.25									

Ordering data

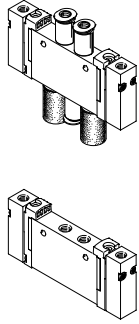
Ordering data	Description	Part no.	Type
In-line valve G1/8			
	2x3/2-way valve		
	Normally closed, pneumatic spring return, internal pneumatic spring supply	573829	VUWG-L14-T32C-A-G18
	Normally open, Pneumatic spring return, internal pneumatic spring supply	573830	VUWG-L14-T32U-A-G18
	1x normally open, 1x normally closed, pneumatic spring return, internal pneumatic spring supply	573831	VUWG-L14-T32H-A-G18
	Normally closed, mechanical spring return	574259	VUWG-L14-T32C-M-G18
	Normally open, Mechanical spring return	574260	VUWG-L14-T32U-M-G18
	1x normally open, 1x normally closed, mechanical spring return	574261	VUWG-L14-T32H-M-G18
	5/2-way valve, monostable		
	Pneumatic/mechanical spring return, internal pneumatic spring supply	573832	VUWG-L14-M52-A-G18
	Mechanical spring return	574262	VUWG-L14-M52-M-G18
	5/2-way valve, bistable		
	–	573833	VUWG-L14-B52-G18
	5/3-way valve		
	Mid-position closed, mechanical spring return	573834	VUWG-L14-P53C-G18
	Mid-position exhausted, mechanical spring return	573835	VUWG-L14-P53E-G18
Mid-position pressurised, mechanical spring return	573836	VUWG-L14-P53U-G18	

Manifold assembly

In-line valves for manifold assembly

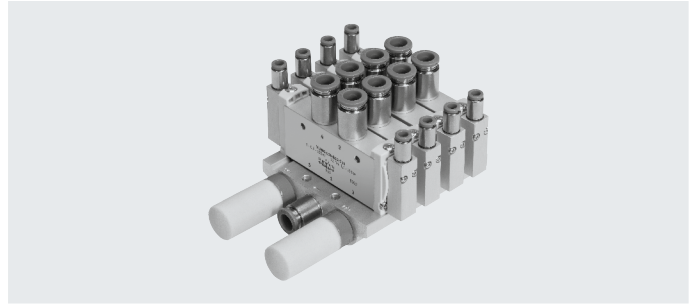

Dimensions

Download CAD data → www.festo.com

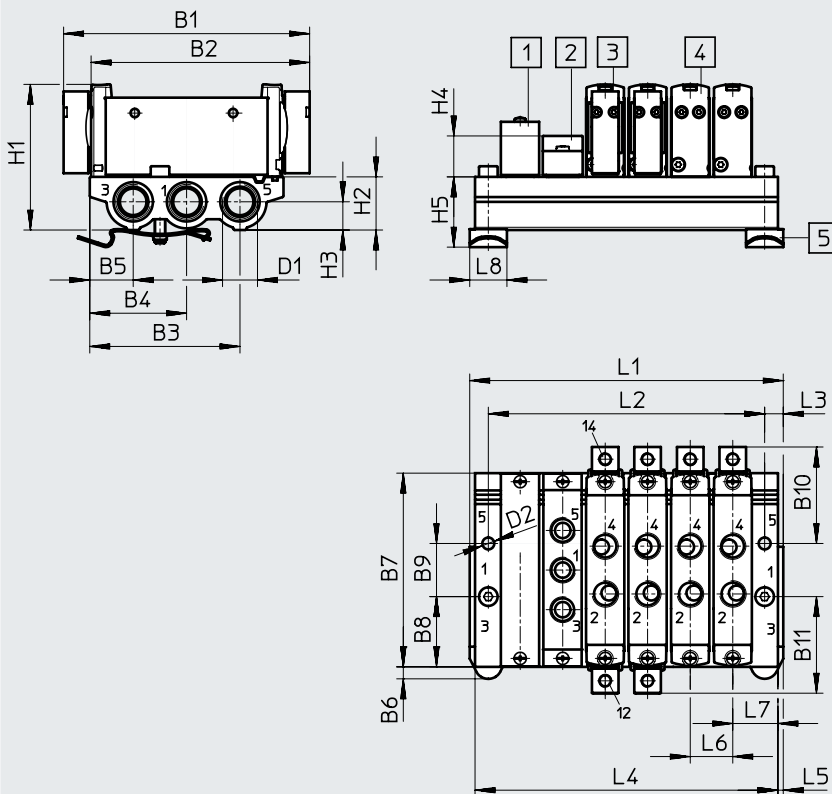

[1] Cover plate VABB-L1-14
[2] Supply plate
VABF-L1-14-P3A4-G18

[3] Pneumatic valve, bistable
[4] Pneumatic valve, monostable

[5] DIN rail mounting
(two M4x25 screws to DIN 912
are required for mounting)

Type	B1	B2	B3	B4	B5	B6	B7	B8	B9	B10	B11	D1
VABM-L1-14S-G14	92.6	82.3	56.6	36.5	16.4	4.5	72.9	26.45	20	36.3	36.3	G1/4

Type	D2	H1	H2	H3	H4	H5	L3	L5	L6	L7
VABM-L1-14S-G14	∅ 4.5	54.8	20	10.6	15.4	26.4	7	2	16	17

Valve positions	2	3	4	5	6	7	8	9	10	12	14	16
L1 [mm]	54	70	86	98	118	134	150	166	182	214	246	278
L2 [mm]	40	56	72	88	104	120	136	152	168	200	232	264
L4 [mm]	50	66	82	98	114	130	146	162	178	210	242	274

Ordering data

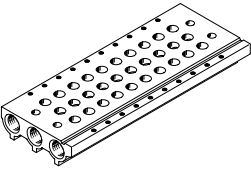
Technical data – Manifold rails	Connection 1, 3, 5	CRC ¹⁾	Material ²⁾	Operating pressure [bar]	Max. tightening torque for assembly [Nm]		
					Valve	DIN rail	Wall
	G1/4	2	Wrought aluminium alloy	-0.9 ... 10	0.65	1.5	3



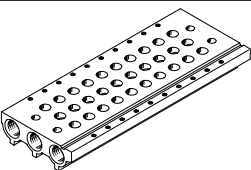

1) Corrosion resistance class CRC 2 to Festo standard FN 940070

Moderate corrosion stress. Indoor applications in which condensation can occur. External visible parts with primarily decorative surface requirements that are in direct contact with a normal industrial environment.

2) Information on materials: RoHS-compliant

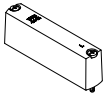

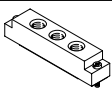
Ordering data – Manifold rail		Description	Part no.	Type
Manifold rail for in-line valves (manifold assembly)				
	For valve size G1/8	2 valve positions	566618	VABM-L1-14S-G14-2
		3 valve positions	566619	VABM-L1-14S-G14-3
		4 valve positions	566620	VABM-L1-14S-G14-4
		5 valve positions	566621	VABM-L1-14S-G14-5
		6 valve positions	566622	VABM-L1-14S-G14-6
		7 valve positions	566623	VABM-L1-14S-G14-7
		8 valve positions	566624	VABM-L1-14S-G14-8
		9 valve positions	566625	VABM-L1-14S-G14-9
		10 valve positions	566626	VABM-L1-14S-G14-10
		12 valve positions	566627	VABM-L1-14S-G14-12
		14 valve positions	566628	VABM-L1-14S-G14-14
16 valve positions	566629	VABM-L1-14S-G14-16		

Ordering data

Ordering data – Accessories			
	Description	Part no.	Type
Cover plate Datasheets → Internet: vabb			
	For manifold rail for G1/8 in-line valves	including screws and seal	569989 VABB-L1-14
Separator Datasheets → Internet: vabd			
	For manifold rail for G1/8 in-line valves	Separator for pressure zones	569996 VABD-10-B
Supply plate Datasheets → Internet: vabf			
	For manifold rail for G1/8 in-line valves	including screws and seal	569993 VABF-L1-14-P3A4-G18
Seals for in-line valves Datasheets → Internet: vabd			
	G1/8	Delivery quantity: 10 sets (each with 2 screws and 1 seal)	566675 VABD-L1-14X-S-G18

Datasheet

Function
 2x3/2C, 2x3/2U, 2x3/2H
 5/2-way, monostable
 5/2-way, bistable
 5/3C, 5/3U, 5/3E

 - Width 18 mm
 - Flow rate
 1000 ... 1380 l/min

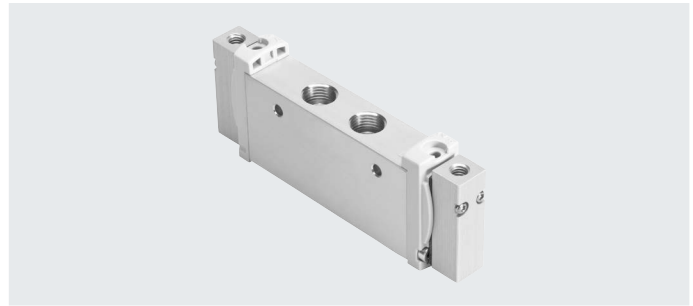

General technical data													
Valve function	T32-A			T32-M			M52-R	B52	M52-M	P53			
Normal position	C ¹⁾	U ²⁾	H ⁴⁾	C ¹⁾	U ²⁾	H ⁴⁾	–	–	–	C ¹⁾	U ²⁾	E ³⁾	
Pneumatic spring return	Yes			No			Yes ⁵⁾	–	No	No			
Mechanical spring return	No			Yes			Yes ⁵⁾	–	Yes	Yes			
Vacuum operation at port 1	No			Yes			No	Yes					
Vacuum operation at port 3/5	Yes												
Design	Piston spool												
Overlap	Positive overlap						Indeterminate overlap	Positive overlap	Indeterminate overlap	Positive overlap	Indeterminate overlap		
Sealing principle	Soft												
Actuation type	Pneumatic												
Type of control	Direct												
Flow direction	Reversible with restrictions			Reversible			Reversible with restrictions	Reversible	Reversible	Reversible			
Exhaust air function	Can be throttled												
Type of mounting	Optionally via through-holes ⁷⁾ or on manifold rail												
Mounting position	Any												
Standard nominal flow rate	[l/min]	1000						1300	1380	1300	1200		
Switching time on/off	[ms]	1 2/36			1 7/25			1 6/40	–	1 2/59	1 7/69		
Switching time changeover	[ms]	–											
Width	[mm]	18											
Connection	1, 2, 3, 4, 5	G1/4											
	12, 14	M5											
Product weight	[g]	160						152	160	152			
Corrosion resistance class CRC ⁶⁾		2											

1) C = Normally closed

2) U = Normally open/mid-position pressurised

3) E = Normally exhausted

4) H = 2x 3/2-way valve in one housing with 1x normally closed and 1x normally open

5) Combined reset method

6) Corrosion resistance class CRC 2 to Festo standard FN 940070

Moderate corrosion stress. Indoor applications in which condensation can occur. External visible parts with primarily decorative surface requirements that are in direct contact with a normal industrial environment.

7) If several valves are to be screwed together via the through-holes to form a block, a minimum distance of 0.3 mm must be ensured by inserting spacers.

Datasheet

Operating and environmental conditions						
Valve function		T32-A ²⁾	T32-M ³⁾	M52-R ⁴⁾	B52	M52-M ³⁾ P53
Operating medium	Compressed air to ISO 8573-1:2010 [7:4:4]					
Note on the operating/pilot medium	Lubricated operation possible (in which case lubricated operation will always be required)					
Operating pressure	[bar]	1.5 ... 10	-0.9 ... 10	2.5 ... 10	-0.9 ... 10	-0.9 ... 10
Pilot pressure ¹⁾	[bar]	1.5 ... 10	3 ... 10	2.5 ... 10	1.5 ... 10	3 ... 10
Ambient temperature	[°C]	-5 ... +60				
Temperature of medium	[°C]	-5 ... +50				
Cleanroom class		ISO class 5				

- 1) Note operating pressure/pilot pressure graph → page 4
- 2) Pneumatic spring
- 3) Mechanical spring
- 4) Mixed, pneumatic/mechanical spring

Information on materials	
Housing	Wrought aluminium alloy
Seals	HNBR, NBR
Note on materials	RoHS-compliant

Dimensions

Download CAD data → www.festo.com

2x3/2-way, 5/2-way and 5/3-way valve

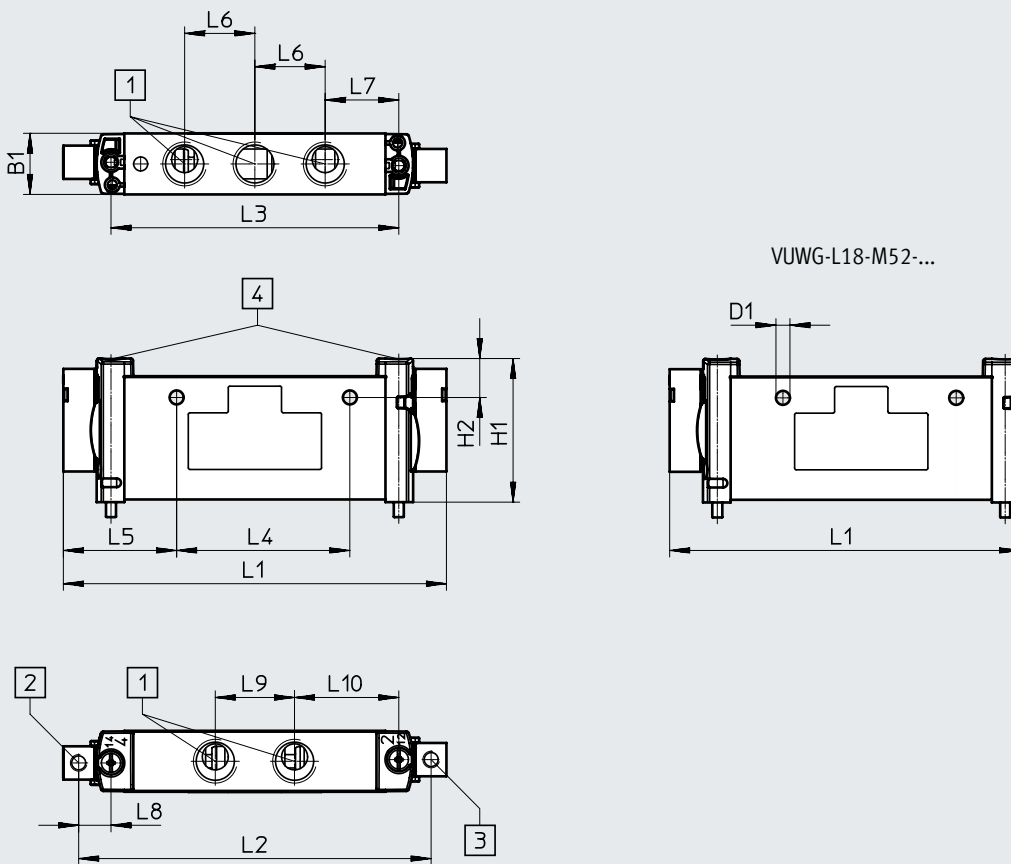

- [1] Ports 1, 2, 3, 4, 5: G1/4
- [2] Port 14: M5
- [3] Port 12: M5
- [4] Mounting screw M3

Type	B1	D1 ø	H1	H2	L1	L2	L3	L4	L5	L6	L7	L8	L9	L10
VUWG-L18-...	18.3	4.2	43.1	6.4	115	96.1	86.4	52	34	21.1	22.1	9.7	23.8	31.3
VUWG-L18-M52-...					105									

Ordering data

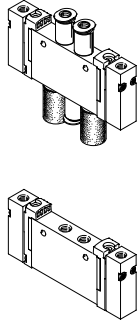
Ordering data	Description	Part no.	Type
In-line valve G1/4			
	2x3/2-way valve		
	Normally closed, pneumatic spring return, internal pneumatic spring supply	574263	VUWG-L18-T32C-A-G14
	Normally open, Pneumatic spring return, internal pneumatic spring supply	574264	VUWG-L18-T32U-A-G14
	1x normally open, 1x normally closed, pneumatic spring return, internal pneumatic spring supply	574265	VUWG-L18-T32H-A-G14
	Normally closed, pneumatic spring return, internal pneumatic spring supply	574266	VUWG-L18-T32C-M-G14
	Normally open, mechanical spring return	574267	VUWG-L18-T32U-M-G14
	1x normally open, 1x normally closed, mechanical spring return	574268	VUWG-L18-T32H-M-G14
	5/2-way valve, monostable		
	Pneumatic/mechanical spring return, internal pneumatic spring supply	574269	VUWG-L18-M52-R-G14
	Mechanical spring return	574270	VUWG-L18-M52-M-G14
	5/2-way valve, bistable		
	–	574271	VUWG-L18-B52-G14
	5/3-way valve		
	Mid-position closed, mechanical spring return	574272	VUWG-L18-P53C-G14
	Mid-position exhausted, mechanical spring return	574273	VUWG-L18-P53E-G14
Mid-position pressurised, mechanical spring return	574274	VUWG-L18-P53U-G14	

Manifold assembly

In-line valves for manifold assembly

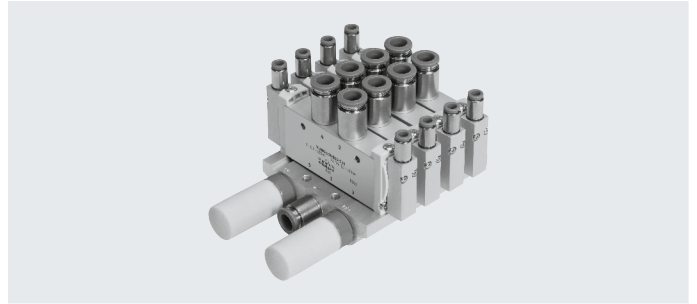

Dimensions

Download CAD data → www.festo.com

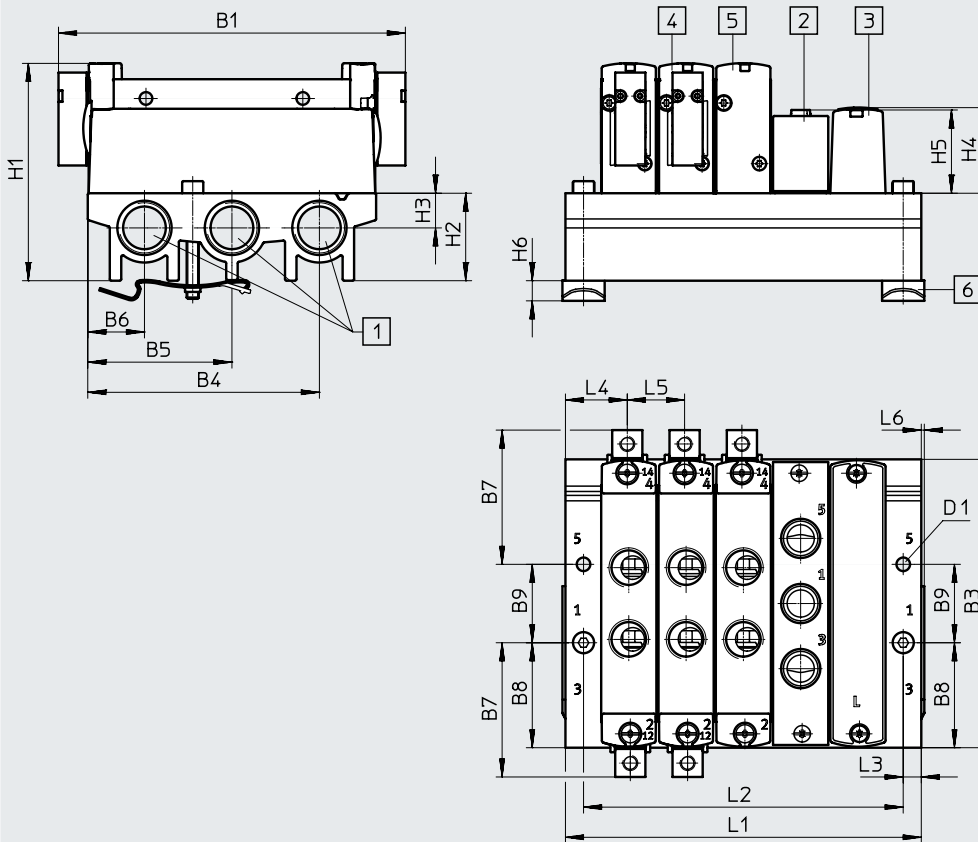

- [1] Ports 1.3 and 5: G3/8
- [2] Cover plate VABB-L1-18
- [3] Supply plate VABF-L1-18-P3A4-G14
- [4] Pneumatic valve, bistable
- [5] Pneumatic valve, monostable
- [6] DIN rail mounting (two M4x35 screws to DIN 912 are required)

Type	B1	B3	B4	B5	B6	B7	B8	B9	D1	H1	H2
VABM-L1-18S-G38	115	95.6	76.8	47.8	18.8	44.5	34.8	26	4.5	72.1	29

Type	H3	H4	H5	H6	L3	L4	L5	L6
VABM-L1-18S-G38	11.5	28.4	27.6	6.5	6	20.5	19	1

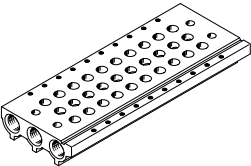

Valve positions	2	3	4	5	6	7	8	9	10	12	14	16
L1 [mm]	61	80	99	118	137	156	175	194	213	251	289	327
L2 [mm]	49	68	87	106	125	144	163	182	201	239	277	315

Ordering data

Technical data – Manifold rails	Connection 1, 3, 5	CRC ¹⁾	Material ²⁾	Operating pressure [bar]	Max. tightening torque for assembly [Nm]		
					Valve	DIN rail	Wall
	G3/8	2	Wrought aluminium alloy	-0.9 ... 10	0.65	1.5	3

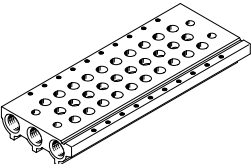
- 1) Corrosion resistance class CRC 2 to Festo standard FN 940070
Moderate corrosion stress. Indoor applications in which condensation can occur. External visible parts with primarily decorative surface requirements that are in direct contact with a normal industrial environment.
- 2) Information on materials: RoHS-compliant.

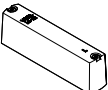
Ordering data – Manifold rail				
	Description		Part no.	Type
Manifold rail for in-line valve				
	For valve size G1/4	2 valve positions	574455	VABM-L1-18S-G38-2
		3 valve positions	574456	VABM-L1-18S-G38-3
		4 valve positions	574457	VABM-L1-18S-G38-4
		5 valve positions	574458	VABM-L1-18S-G38-5
		6 valve positions	574459	VABM-L1-18S-G38-6
		7 valve positions	574460	VABM-L1-18S-G38-7
		8 valve positions	574461	VABM-L1-18S-G38-8
		9 valve positions	574462	VABM-L1-18S-G38-9
		10 valve positions	574463	VABM-L1-18S-G38-10
		12 valve positions	574464	VABM-L1-18S-G38-12
	14 valve positions	574465	VABM-L1-18S-G38-14	
	16 valve positions	574466	VABM-L1-18S-G38-16	

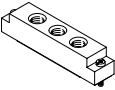
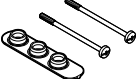
Ordering data – Accessories				
	Description		Part no.	Type
Cover plate Datasheets → Internet: vabb				
	For manifold rail for G1/4 in-line valves	including screws and seal	574482	VABB-L1-18
Separator Datasheets → Internet: vabd				
	For manifold rail for G1/4 in-line valves	Separator for pressure zones	574483	VABD-14-B
Supply plate Datasheets → Internet: vabf				
	For manifold rail for G1/4 in-line valves	including screws and seal	574481	VABF-L1-18-P3A4-G14
Seals for in-line valves Datasheets → Internet: vabd				
	G1/4	Delivery quantity: 10 sets (each with 2 screws and 1 seal)	574479	VABD-L1-18X-S-G14

 **Note**

Connect supply plate at port 1 with compressed air. Reverse operation (pressure at port 3/5) is not permissible.

Datasheet

Function
5/2-way, monostable
5/2-way, bistable
5/3C, 5/3U, 5/3E

-  - Width 10 mm

-  - Flow rate
80 ... 100 l/min

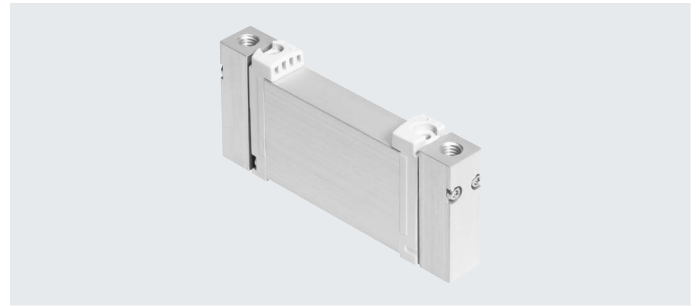

General technical data

Valve function	M52-R	B52	M52-M	P53
Normal position	–	–	–	C ¹⁾ U ²⁾ E ³⁾
Pneumatic spring return	Yes ⁴⁾	–	No	No
Mechanical spring return	Yes ⁴⁾	–	Yes	Yes
Vacuum operation at port 1	No	Yes		
Vacuum operation at port 3/5	Yes			
Design	Piston spool			
Sealing principle	Soft			
Actuation type	Pneumatic			
Type of control	Direct			
Pneumatic spring supply	External	–	–	–
Exhaust air function	Can be throttled			
Type of mounting	On manifold rail			
Mounting position	Any			
Standard nominal flow rate	[l/min]	100	80	90
Switching time on/off	[ms]	5/11	–	5/16
Switching time changeover	[ms]	–	5	–
Width	[mm]	10		
Connection	1, 3, 5	M7 in manifold rail		
	2, 4	M5 in manifold rail		
	12, 14	M5		
Product weight	[g]	37	40	34
Corrosion resistance class CRC ⁵⁾		2		

1) C = Normally closed

2) U = Normally open/mid-position pressurised

3) E = Normally exhausted

4) Combined reset method

5) Corrosion resistance class CRC 2 to Festo standard FN 940070

Moderate corrosion stress. Indoor applications in which condensation can occur. External visible parts with primarily decorative surface requirements that are in direct contact with a normal industrial environment.

Datasheet

Operating and environmental conditions					
Valve function		M52-R ³⁾	B52	M52-M ²⁾	P53
Operating medium		Compressed air to ISO 8573-1:2010 [7:4:4]			
Note on the operating/pilot medium		Lubricated operation possible (in which case lubricated operation will always be required)			
Operating pressure	[bar]	2.5 ... 10	-0.9 ... 10	-0.9 ... 8	-0.9 ... 10
Pilot pressure ¹⁾	[bar]	2.5 ... 10	1.5 ... 10	3 ... 10	
Ambient temperature	[°C]	-5 ... +60			
Temperature of medium	[°C]	-5 ... +50			

1) Note operating pressure/pilot pressure graph → page 4

2) Mechanical spring

3) Mixed, pneumatic/mechanical spring

Information on materials	
Housing	Anodised aluminium
Seals	HNBR, NBR
Note on materials	RoHS-compliant

Dimensions

Download CAD data → www.festo.com

5/2- and 5/3-way valves

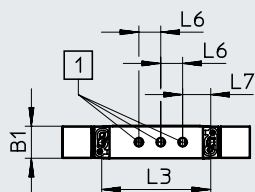

VUWG-L10A-M52-...-M3

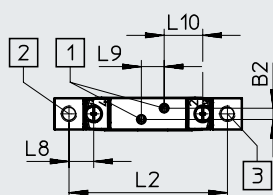
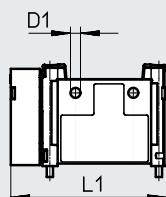
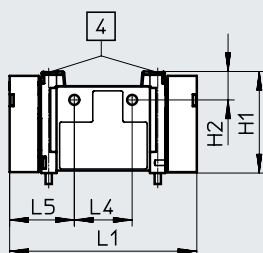

[1] Ports 1, 2, 3, 4, 5

[2] Port 14: M5

[3] Port 12: M5

[4] Retaining screw M2.5

Type	B1	H1	L1	L2	L3	L8
VUWG-B10A-...	10.3	32.5	59.9	50.7	34.9	7.9
VUWG-B10A-M52-...			49.9			

Manifold assembly

Sub-base valve for manifold assembly
Connection M5

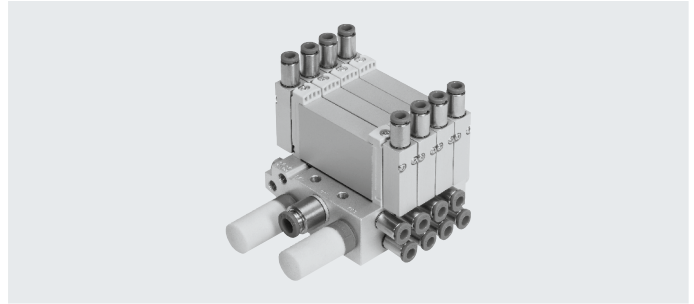

Dimensions

Download CAD data → www.festo.com

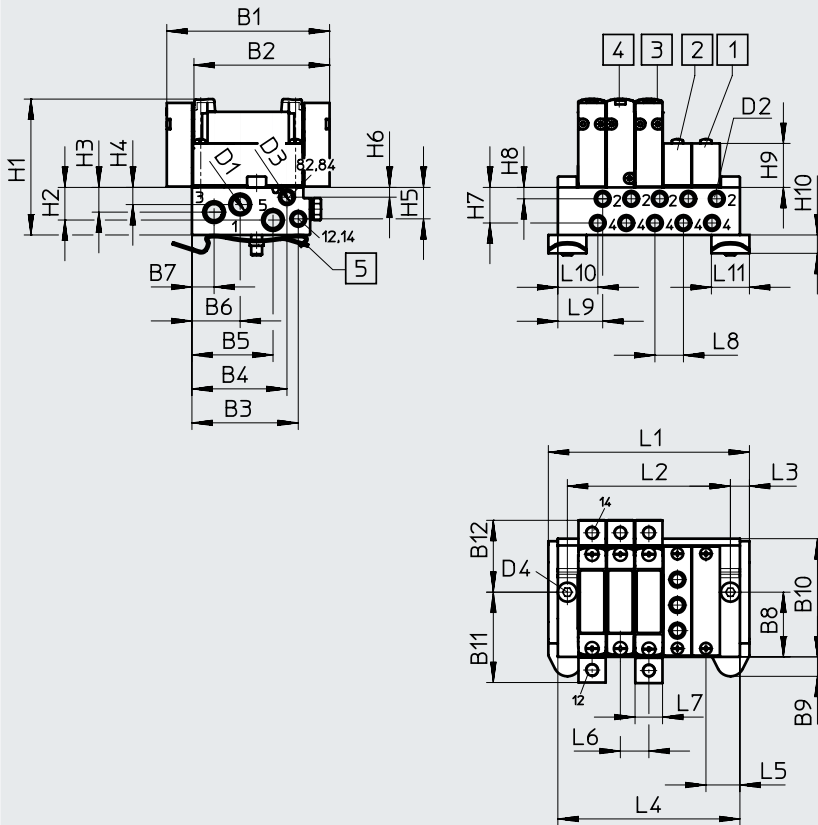

- [1] Cover plate VABB-L1-10A
- [2] Supply plate VABF-L1-10A-P3A4-M5
- [3] Pneumatic valve, bistable
- [4] Pneumatic valve, monostable
- [5] DIN rail mounting (two M4x25 screws to DIN 912 are required)

Type	B1	B2	B3	B4	B5	B6	B7	B8	B9	B10	B11	B12
VABM-L1-10AW-M7	59.9	49.9	39.1	35	29.8	17.8	8.2	24	7.15	43.5	33.45	26.45

Type	H1	H2	H3	H4	H5	H6	H7	H8	H9	H10	D1	D2
VABM-L1-10AW-M7	50	12	9.1	6.3	11.6	3.6	13.1	4.2	16.2	6.8	M7	M5



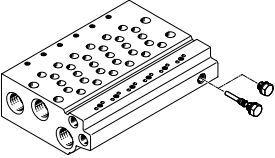

Type	D3	D4	L3	L5	L6	L7	L8	L9	L10	L11
VABM-L1-10AW-M7	M5	∅ 4.5	7	12.5	10.5	10.2	10.5	16.5	14.7	11

Valve positions	2	3	4	5	6	7	8	9	10	12	14	16
L1 [mm]	42.5	53	63.5	74	84.5	96	106.5	116	126.5	147.5	168.5	189.5
L2 [mm]	28.5	39	49.5	60	70.5	81	91.5	102	112.5	133.5	154.5	175.5
L4 [mm]	35.5	46	56.5	67	77.5	89	99.5	109	119.5	140.5	161.5	182.5

Ordering data

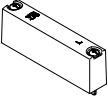
Technical data – Manifold rails ¹⁾	Connection			CRC ²⁾	Material ³⁾	Operating pressure [bar]	Max. tightening torque for assembly [Nm]		
	2, 4	1, 3, 5	1 2/14, 8 2/84				Valve	DIN rail	Wall
	M5	M7	M5	2	Wrought aluminium alloy	-0.9 ... 10	0.45	1.5	1.5

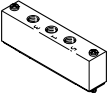
- 1) Blanking plugs are included with the manifold rail.
- 2) Corrosion resistance class CRC 2 to Festo standard FN 940070
Moderate corrosion stress. Indoor applications in which condensation can occur. External visible parts with primarily decorative surface requirements that are in direct contact with a normal industrial environment.
- 3) Information on materials: RoHS-compliant.

Ordering data – Accessories				
	Description		Part no.	Type
Cover plate Datasheets → Internet: vabb				
	For manifold rail 10AW	including screws and seal	569986	VABB-L1-10A
Separator Datasheets → Internet: vabd				
	For manifold rail 10AW	Separator for pressure zones	570872	VABD-4.2-B
Supply plate Datasheets → Internet: vabf				
	For manifold rail 10AW	including screws and seal	569990	VABF-L1-10A-P3A4-M5
Seals Datasheets → Internet: vabd				
	For sub-base valves B10A	Delivery quantity: 10 sets (each with 2 screws and 1 seal)	566671	VABD-L1-10AB-S-M3

Datasheet

Function

2x3/2C, 2x3/2U, 2x3/2H
 5/2-way, monostable
 5/2-way, bistable
 5/3C, 5/3U, 5/3E

-  - Width 10 mm

-  - Flow rate
 120 ... 270 l/min

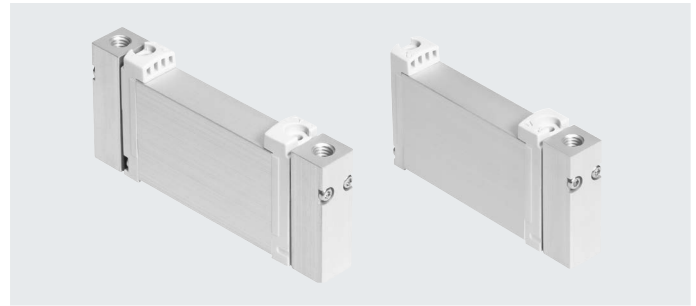

General technical data

Valve function	T32-A			T32-M			M52-R	B52	M52-M	P53		
Normal position	C ¹⁾	U ²⁾	H ⁴⁾	C ¹⁾	U ²⁾	H ⁴⁾	-	-	-	C ¹⁾	U ²⁾	E ³⁾
Pneumatic spring return	Yes			No			Yes ⁵⁾	-	No	No		
Mechanical spring return	No			Yes			Yes ⁵⁾	-	Yes	Yes		
Vacuum operation at port 1	No			Yes			Yes ⁷⁾	Yes				
Vacuum operation at port 3/5	Yes											
Design	Piston spool											
Sealing principle	Soft											
Actuation type	Pneumatic											
Type of control	Direct											
Pneumatic spring supply	External			-			External	-	-	-		
Exhaust air function	Can be throttled											
Type of mounting	On manifold rail											
Mounting position	Any											
Standard nominal flow rate M5	[l/min]	150			130	120	210		180		200	
Standard nominal flow rate M7	[l/min]	160			140	130	270		230		250	
Switching time on/off	[ms]	4/9			6/7		6/12		-	7/16		8/25
Switching time changeover	[ms]	-			-		-		5	-		11
Width	[mm]	10										
Connection	1, 3, 5	G1/8 in manifold rail										
	2, 4	M5/M7 in manifold rail										
	12, 14	M5										
Product weight	[g]	48			51		45		48	41		48
Corrosion resistance class CRC ⁶⁾	2											

- 1) C = Normally closed
- 2) U = Normally open/mid-position pressurised
- 3) E = Normally exhausted
- 4) H = 2x 3/2-way valve in one housing with 1x normally closed and 1x normally open
- 5) Combined reset method
- 6) Corrosion resistance class CRC 2 to Festo standard FN 940070
 Moderate corrosion stress. Indoor applications in which condensation can occur. External visible parts with primarily decorative surface requirements that are in direct contact with a normal industrial environment.
- 7) Only with external pneumatic spring supply

Datasheet

Operating and environmental conditions							
Valve function		T32-A ²⁾	T32-M ³⁾	M52-R ⁴⁾	B52	M52-M ²⁾	P53
Operating medium		Compressed air to ISO 8573-1:2010 [7:4:4]					
Note on the operating/pilot medium		Lubricated operation possible (in which case lubricated operation will always be required)					
Operating pressure	[bar]	1.5 ... 10	-0.9 ... 10	2.5 ... 10	-0.9 ... 10	-0.9 ... 8	-0.9 ... 10
Pilot pressure ¹⁾	[bar]	1.5 ... 10	3 ... 10	2.5 ... 10	1.5 ... 10	3 ... 10	
Ambient temperature	[°C]	-5 ... +60					
Temperature of medium	[°C]	-5 ... +50					

- 1) Note operating pressure/pilot pressure graph → page 4
- 2) Pneumatic spring
- 3) Mechanical spring
- 4) Mixed, pneumatic/mechanical spring

Information on materials	
Housing	Wrought aluminium alloy
Seals	HNBR, NBR
Note on materials	RoHS-compliant

Dimensions

Download CAD data → www.festo.com

2x3/2-way, 5/2-way and 5/3-way valve

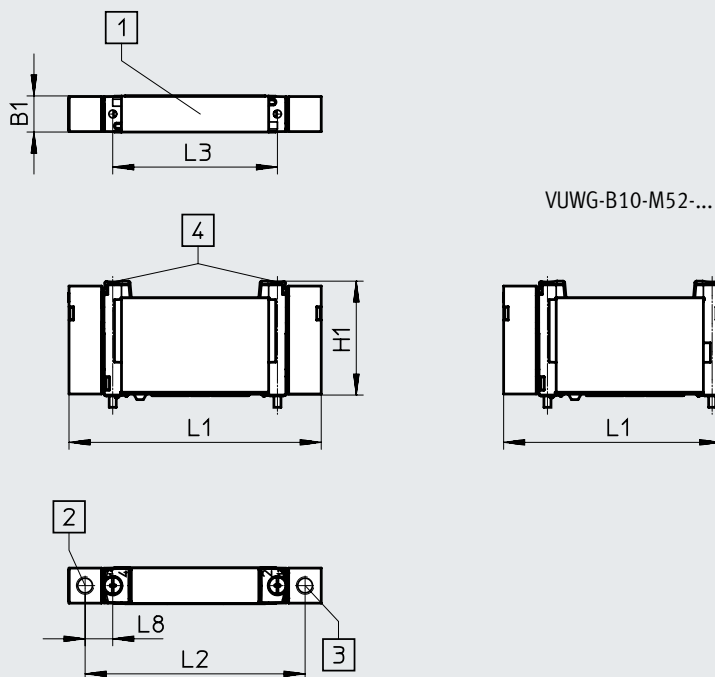

[1] Ports 1, 2, 3, 4, 5

[2] Port 14: M5

[4] Retaining screw M2.5

[3] Port 12: M5

Type	B1	H1	L1	L2	L3	L8
VUWG-B10-...	10.3	32.5	72	62.8	47	7.9
VUWG-B10-M52-...			62			

Manifold assembly

Sub-base valve for manifold assembly
M5 or M7 connection

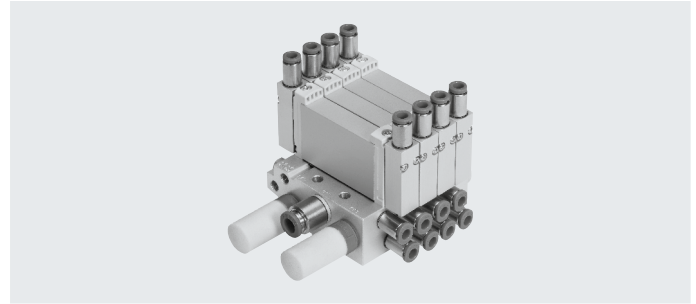

Dimensions

Download CAD data → www.festo.com

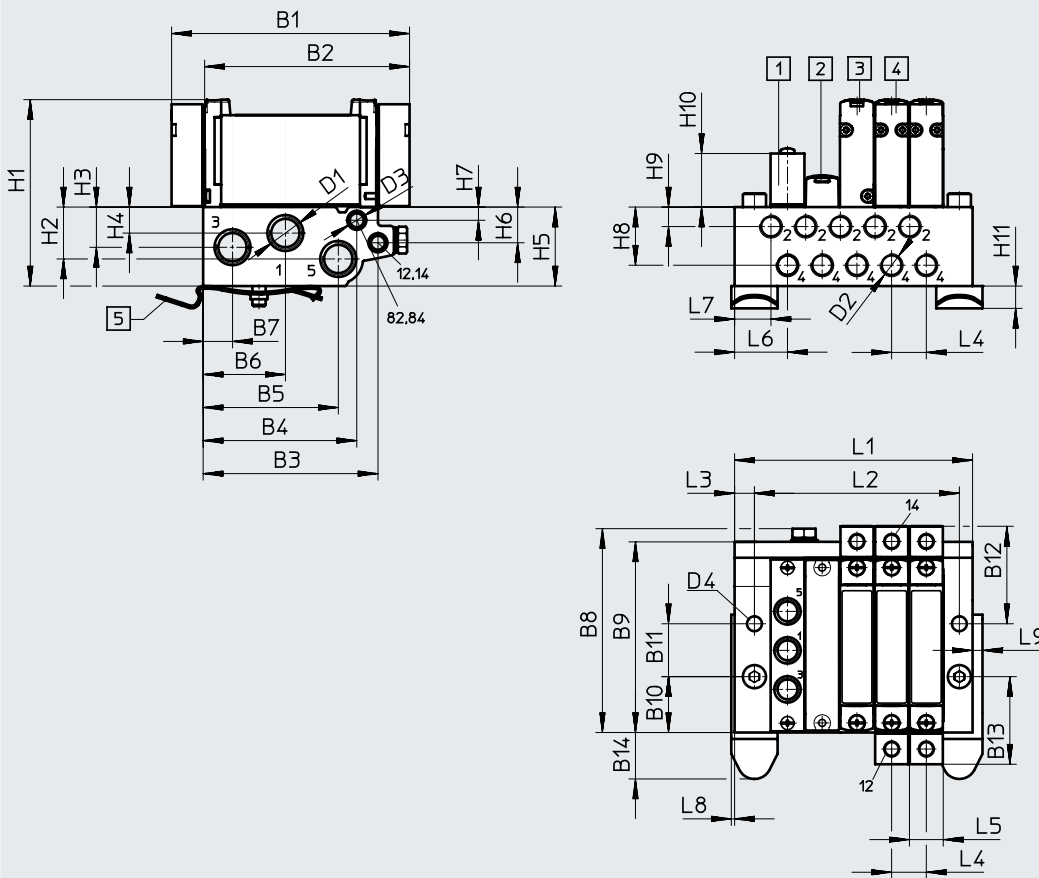

- [1] Supply plate
VABF-L1-10-P3A4-M5
- [2] Cover plate
VABB-L1-10-W
- [3] Pneumatic valve, monostable,
VUWG-B10-M52
- [4] Pneumatic valve, bistable,
VUWG-B10
- [5] DIN rail mounting (two M4x30
screws to DIN 912 are required)

Type	B1	B2	B3	B4	B5	B6	B7	B8	B9	B10	B11	B12
VABM-L1-...G18	72	62	52.9	46.5	40.9	24.9	8.9	62	57.7	16.9	16	29.5

Type	B13	B14	D1	D2	D3	D4	H1	H2	H3	H4	H5	H6
VABM-L1-...G18	26.5	14.1	G1/8	M5	M5	4.5	56.4	15.7	12.2	7.9	23.9	10.8



Type	H7	H8	H9	H10	H11	L3	L4	L5	L6	L7	L8	L9	L15
VABM-L1-...G18	4	17.6	5.9	16.2	6.8	4	10.5	10.3	16	11	1	3	10

Valve positions	2	3	4	5	6	7	8	9	10	12	14	16	22
L1 [mm]	48.5	59	69.5	80	90.5	101	111.5	122	132.5	153.5	174.5	195.5	258.5
L2 [mm]	30.5	41	51.5	62	72.5	83	93.5	104	114.5	135.5	156.5	177.5	240.5

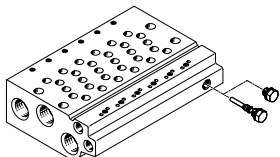
Ordering data

Technical data – Manifold rails ¹⁾	Connection			CRC ²⁾	Material ³⁾	Operating pressure [bar]	Max. tightening torque for assembly [Nm]		
	2, 4	1, 3, 5	1 2/14, 8 2/84				Valve	DIN rail	Wall
	M5 or M7	G1/8	M5	2	Wrought aluminium alloy	-0.9 ... 10	0.45	1.5	3

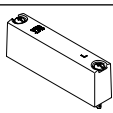
- 1) Blanking plugs are included with the manifold rail.
- 2) Corrosion resistance class CRC 2 to Festo standard FN 940070
Moderate corrosion stress. Indoor applications in which condensation can occur. External visible parts with primarily decorative surface requirements that are in direct contact with a normal industrial environment.
- 3) Information on materials: RoHS-compliant.

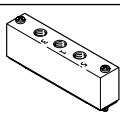
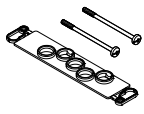
Ordering data – Accessories				
	Description	Part no.	Type	
Cover plate Datasheets → Internet: vabb				
	For manifold rail 10W/10HW, Sub-base valves	including screws and seal	566495	VABB-L1-10-W
Separator Datasheets → Internet: vabd				
	For manifold rail 10W and 10HW, Sub-base valves	Separator for pressure zones	569994	VABD-6-B
Supply plate Datasheets → Internet: vabf				
	For manifold rail 10W	including screws and seal	569991	VABF-L1-10-P3A4-M5
	For manifold rail 10HW		569992	VABF-L1-10-P3A4-M7
Seals Datasheets → Internet: vabd				
	For sub-base valves B10	Delivery quantity: 10 sets (each with 2 screws and 1 seal)	566674	VABD-L1-10B-S-M7

Datasheet

Function

2x3/2C, 2x3/2U, 2x3/2H

5/2-way, monostable

5/2-way, bistable

5/3C, 5/3U, 5/3E

-  - Width 14 mm

-  - Flow rate
410 ... 580 l/min

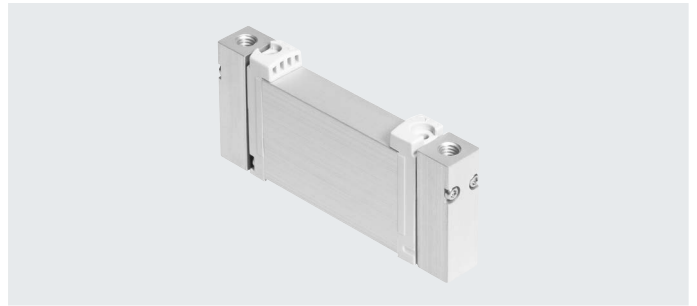

General technical data

Valve function	T32-A			T32-M			M52-A	B52	M52-M	P53			
	C ¹⁾	U ²⁾	H ⁴⁾	C ¹⁾	U ²⁾	H ⁴⁾	-	-	-	C ¹⁾	U ²⁾	E ³⁾	
Normal position	C ¹⁾	U ²⁾	H ⁴⁾	C ¹⁾	U ²⁾	H ⁴⁾	-	-	-	C ¹⁾	U ²⁾	E ³⁾	
Pneumatic spring return	Yes			No			Yes	-	No	No			
Mechanical spring return	No			Yes			No	-	Yes	Yes			
Vacuum operation at port 1	No			Yes			No	Yes					
Vacuum operation at port 3/5	Yes												
Design	Piston spool												
Sealing principle	Soft												
Actuation type	Pneumatic												
Type of control	Direct												
Pneumatic spring supply	External			-			External	-	-	-			
Exhaust air function	Can be throttled												
Type of mounting	On manifold rail												
Mounting position	Any												
Standard nominal flow rate	[l/min]	540	510	540	430	410	580			540	510		
Switching time on/off	[ms]	6/19			9/13			1 2/22	-	1 2/32	8/30		
Switching time changeover	[ms]	-			-			6		-	16		
Width	[mm]	14											
Connection	1, 3, 5	G1/4 in manifold rail											
	2, 4	G1/8 in manifold rail											
	12, 14	M5											
Product weight	[g]	83			83			75	81				
Corrosion resistance class CRC ⁵⁾	2												

1) C = Normally closed

2) U = Normally open/mid-position pressurised

3) E = Normally exhausted

4) H = 2x 3/2-way valve in one housing with 1x normally closed and 1x normally open

5) Corrosion resistance class CRC 2 to Festo standard FN 940070

Moderate corrosion stress. Indoor applications in which condensation can occur. External visible parts with primarily decorative surface requirements that are in direct contact with a normal industrial environment.

Datasheet

Operating and environmental conditions							
Valve function		T32-A ²⁾	T32-M ³⁾	M52-A ²⁾	B52	M52-M ³⁾	P53
Operating medium		Compressed air to ISO 8573-1:2010 [7:4:4]					
Note on the operating/pilot medium		Lubricated operation possible (in which case lubricated operation will always be required)					
Operating pressure	[bar]	1.5 ... 10	-0.9 ... 10	2.5 ... 10	-0.9 ... 10	-0.9 ... 8	-0.9 ... 10
Pilot pressure ¹⁾	[bar]	1.5 ... 10	3 ... 10	2.5 ... 10	1.5 ... 10	3 ... 10	
Ambient temperature	[°C]	-5 ... +60					
Temperature of medium	[°C]	-5 ... +50					

1) Note operating pressure/pilot pressure graph → page 4

2) Pneumatic spring

3) Mechanical spring

Information on materials	
Housing	Wrought aluminium alloy
Seals	HNBR, NBR
Note on materials	RoHS-compliant

Dimensions

Download CAD data → www.festo.com

2x3/2-way, 5/2-way and 5/3-way valve

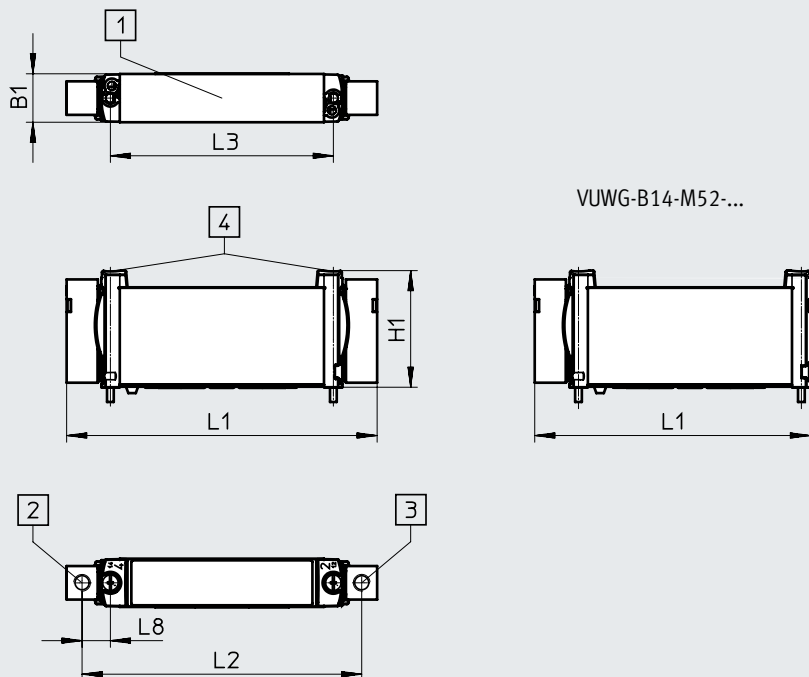

[1] Ports 1, 2, 3, 4, 5

[2] Port 14: M5

[4] Retaining screw M2.5

[3] Port 12: M5

Type	B1	H1	L1	L2	L3	L8
VUWG-B14-...	14.4	34.8	92.6	83.4	66.5	8.5
VUWG-B14-M52-...			82.3			

Manifold assembly

Sub-base valve for manifold assembly
Connection G1/8

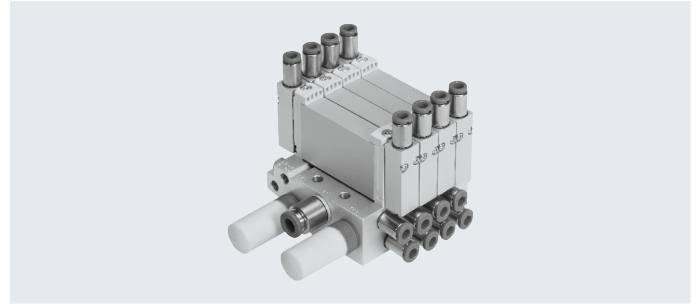

Dimensions

Download CAD data → www.festo.com

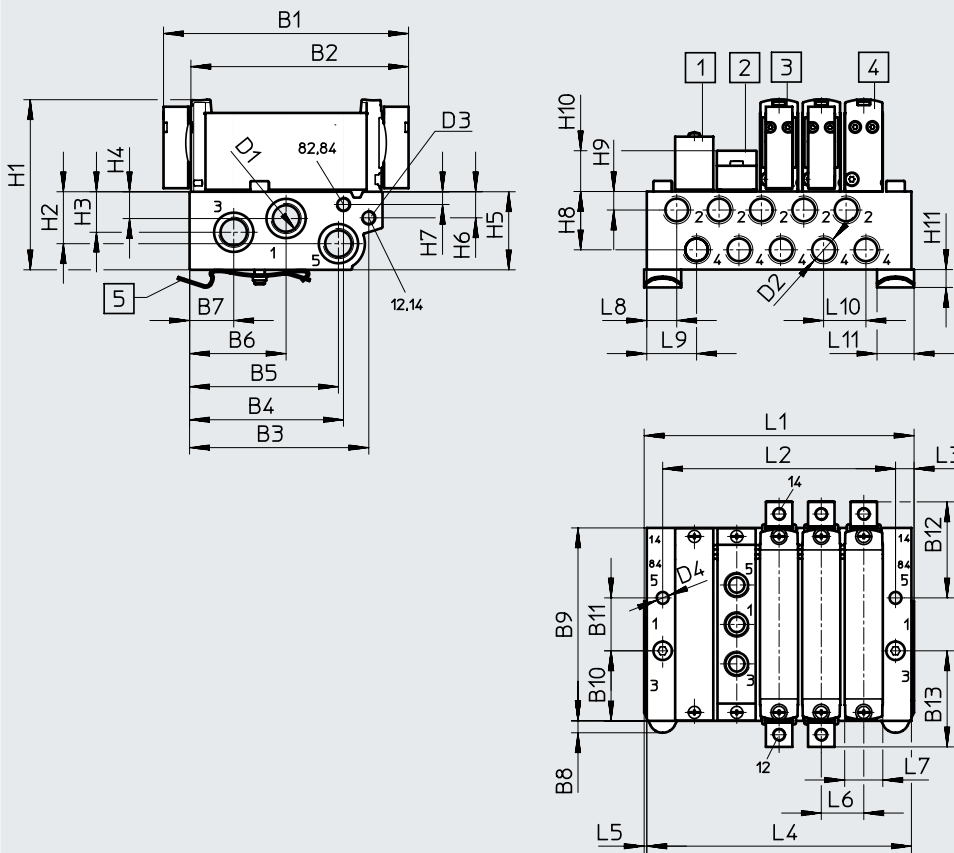

- [1] Cover plate VABB-L1-14
- [2] Supply plate VABF-L1-14-P3A4-G18
- [3] Pneumatic valve, bistable
- [4] Pneumatic valve, monostable
- [5] DIN rail mounting (two M4x25 screws to DIN 912 are required)

Type	B1	B2	B3	B4	B5	B6	B7	B8	B9	B10	B11	B12
VUWG-B14 -...-F ...	92.6	82.3	67.7	58.2	56.3	36.6	16.7	4.5	72.9	26.5	20	36.3

Type	B13	D1	D2	D3	D4	H1	H2	H3	H4	H5	H6	H7
VUWG-B14 -...-F ...	36.3	G1/4	G1/8	M5	∅4.5	64.3	19.6	15.3	10.1	29.5	9.8	4.8



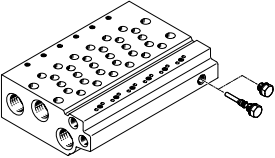

Type	H8	H9	H10	H11	L3	L5	L6	L7	L8	L9	L10	L11
VUWG-B14 -...-F ...	22.1	7	15.4	6.8	6	1	16	14.4	11.3	18.5	16	14

Valve positions	2	3	4	5	6	7	8	9	10	12	14	16
L1 [mm]	56.3	72.3	88.3	104.3	120.3	136.3	152.3	168.3	184.3	216.3	248.3	280.3
L2 [mm]	40	56	72	88	104	120	136	152	168	200	232	264
L4 [mm]	54.3	70.3	86.3	102.3	118.3	134.3	150.3	166.3	182.3	214.3	246.6	278.3

Ordering data

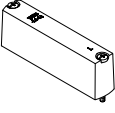
Technical data – Manifold rails ¹⁾	Connection			CRC ²⁾	Material ³⁾	Operating pressure [bar]	Max. tightening torque for assembly [Nm]		
	2, 4	1, 3, 5	1 2/14, 8 2/84				Valve	DIN rail	Wall
	G1/8	G1/4	M5	2	Wrought aluminium alloy	-0.9 ... 10	0.65	1.5	3

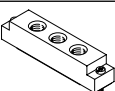
- 1) Blanking plugs are included with the manifold rail.
- 2) Corrosion resistance class CRC 2 to Festo standard FN 940070
Moderate corrosion stress. Indoor applications in which condensation can occur. External visible parts with primarily decorative surface requirements that are in direct contact with a normal industrial environment.
- 3) Information on materials: RoHS-compliant.

Ordering data – Accessories				
	Description		Part no.	Type
Cover plate Datasheets → Internet: vabb				
	For manifold rail 14W, Sub-base valves	including screws and seal	569989	VABB-L1-14
Separator Datasheets → Internet: vabd				
	For manifold rail 14W, Sub-base valves	Separator for pressure zones	569996	VABD-10-B
Supply plate Datasheets → Internet: vabf				
	For manifold rail 14W	including screws and seal	569993	VABF-L1-14-P3A4-G18
Seals Datasheets → Internet: vabd				
	For sub-base valves B14	Delivery quantity: 10 sets (each with 2 screws and 1 seal)	566676	VABD-L1-14B-S-G18

Datasheet

Function
 2x3/2C, 2x3/2U, 2x3/2H
 5/2-way, monostable
 5/2-way, bistable
 5/3C, 5/3U, 5/3E

-  - Width 18 mm

-  - Flow rate
 900 ...1000 l/min

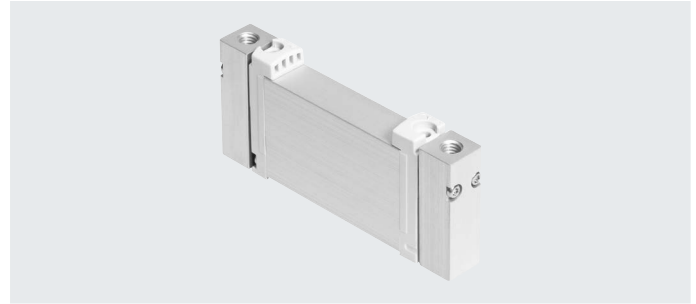

General technical data

Valve function	T32-A			T32-M			M52-R	B52	M52-M	P53			
Normal position	C ¹⁾	U ²⁾	H ⁴⁾	C ¹⁾	U ²⁾	H ⁴⁾	-	-	-	C ¹⁾	U ²⁾	E ³⁾	
Pneumatic spring return	Yes			No			Yes ⁵⁾	-	No	No			
Mechanical spring return	No			Yes			Yes ⁵⁾	-	Yes	Yes			
Vacuum operation at port 1	No			Yes			No	Yes					
Vacuum operation at port 3/5	Yes												
Design	Piston spool												
Sealing principle	Soft												
Actuation type	Pneumatic												
Type of control	Direct												
Pneumatic spring supply	External			-			External	-	-	-			
Exhaust air function	Can be throttled												
Type of mounting	On manifold rail												
Mounting position	Any												
Standard nominal flow rate	[l/min] 900						1000			950			
Switching time on/off	[ms] 1 2/36			1 7/25			1 6/40			-		1 2/59	1 7/69
Switching time changeover	[ms] -									12		-	34
Width	[mm] 18												
Connection	1, 3, 5			G3/8 in manifold rail									
	2, 4			G1/4 in manifold rail									
	12, 14			M5									
Product weight	[g] 83			83			75		81				
Corrosion resistance class CRC ⁶⁾	2												

- 1) C = Normally closed
- 2) U=Normally open/mid-position pressurised
- 3) E = Normally exhausted
- 4) H=2x 3/2-way valve in one housing with 1x normally closed and 1x normally open
- 5) Combined reset method
- 6) Corrosion resistance class CRC 2 to Festo standard FN 940070
 Moderate corrosion stress. Indoor applications in which condensation can occur. External visible parts with primarily decorative surface requirements that are in direct contact with a normal industrial environment.

Datasheet

Operating and environmental conditions						
Valve function		T32-A ²⁾	T32-M ³⁾	M52-R ⁴⁾	B52	M52-M ³⁾ P53
Operating medium		Compressed air to ISO 8573-1:2010 [7:4:4]				
Note on the operating/pilot medium		Lubricated operation possible (in which case lubricated operation will always be required)				
Operating pressure	[bar]	1.5 ... 10	-0.9 ... 10	2.5 ... 10	-0.9 ... 10	-0.9 ... 8 -0.9 ... 10
Pilot pressure ¹⁾	[bar]	1.5 ... 10	3 ... 10	2.5 ... 10	1.5 ... 10	3 ... 10
Ambient temperature	[°C]	-5 ... +60				
Temperature of medium	[°C]	-5 ... +50				

- 1) Note operating pressure/pilot pressure graph → page 4
- 2) Pneumatic spring
- 3) Mechanical spring
- 4) Mixed, pneumatic/mechanical spring

Information on materials	
Housing	Wrought aluminium alloy
Seals	HNBR, NBR
Note on materials	RoHS-compliant

Dimensions

Download CAD data → www.festo.com

2x3/2-way, 5/2-way and 5/3-way valve

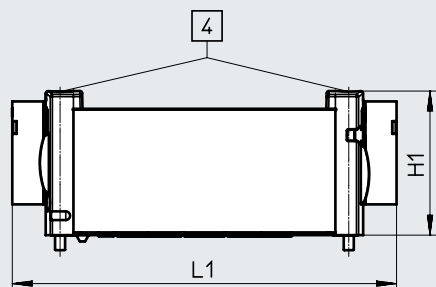
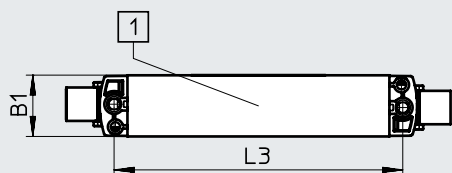

VUWG-B18-M52-...

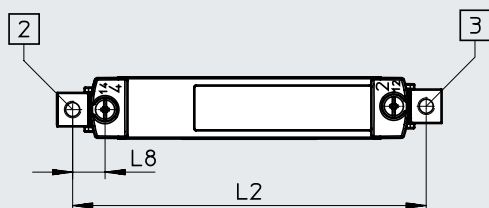
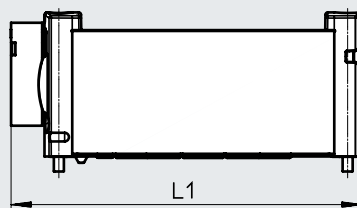

[1] Ports 1, 2, 3, 4, 5

[2] Port 14: M5

[3] Port 12: M5

[4] Retaining screw M3

Type	B1	H1	L1	L2	L3	L8
VUWG-B18-...	18.3	43.1	115	96.1	86.4	9.7
VUWG-B18-M52-...			105			

Manifold assembly

Sub-base valve for manifold assembly
Connection G1/8

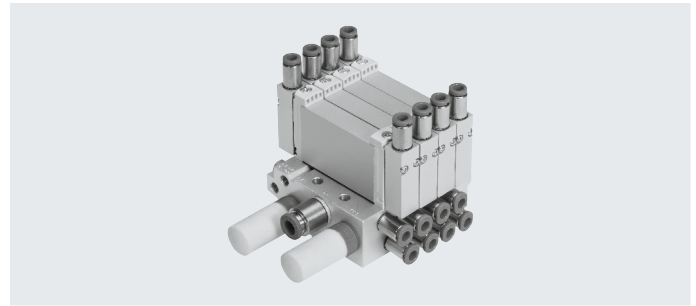

Dimensions

Download CAD data → www.festo.com

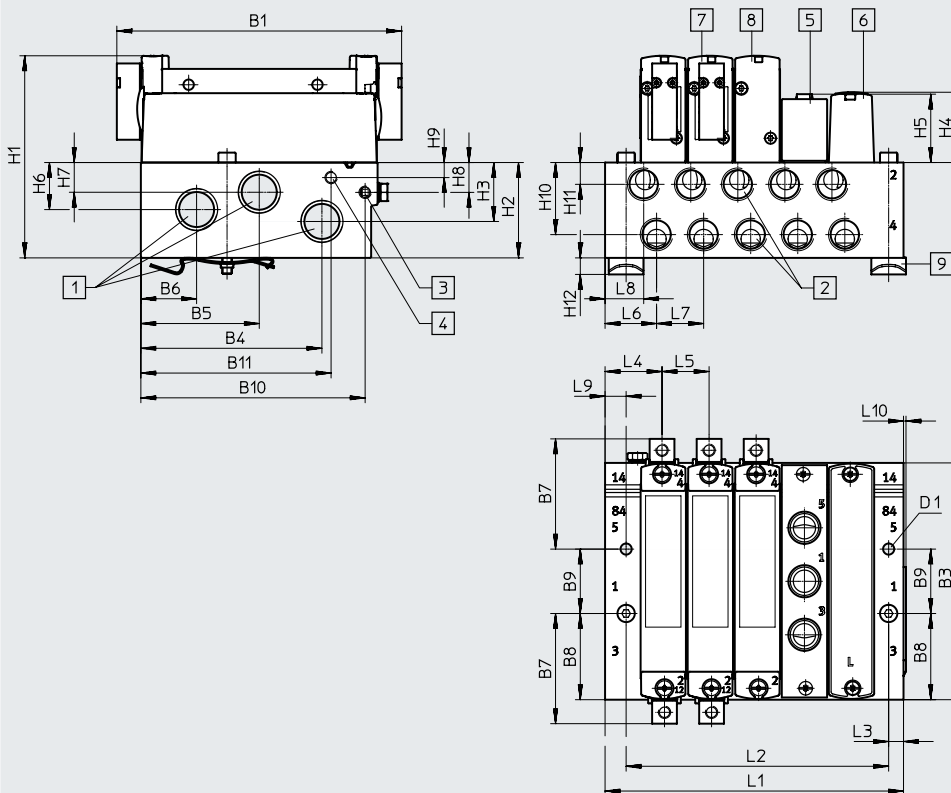

- | | | | |
|--|--|---|---|
| [1] Ports 1, 3 and 5:
G3/8 (at both ends) | [3] Port 12/14 for external pilot air:
M5 | [5] Supply plate
VABF-L1-18-P3A4-G14 | [8] Pneumatic valve
Single solenoid |
| [2] Ports 2 and 4:
G1/4 | [4] Port 82/84 for external pilot air:
M5 | [6] Blanking plate
VABB-L1-18 | [9] DIN rail mounting
(two M4x40 screws to DIN 912
are required for mounting) |
| | | [7] Pneumatic valve, bistable | |

Type	B1	B3	B4	B5	B6	B7	B8	B9	B10	B11	D1	H1
VUWG-B14 -...-F ...	115	95.6	73.1	47.8	22.5	51.7	34.8	26	90.6	76.8	4.5	81.6

Type	H2	H3	H4	H5	H6	H7	H8	H9	H10	H11	H12	L3
VUWG-B14 -...-F ...	38.5	23.8	28.4	27.6	19	12	12.1	6.1	29.1	8.8	6.5	6



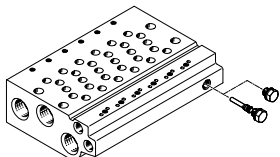

Type	L4	L5	L6	L7	L8	L9	L10
VUWG-B14 -...-F ...	23	19	20.8	19	15.6	8.5	1

Valve positions	2	3	4	5	6	7	8	9	10	12	14	16
L1 [mm]	63.5	82.5	101.5	120.5	139.5	158.5	177.5	196.5	215.5	253.5	291.5	329.5
L2 [mm]	49	68	87	106	125	144	163	182	201	239	277	315



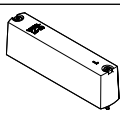

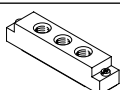
Ordering data

Technical data – Manifold rails ¹⁾	Connection			CRC ²⁾	Material ³⁾	Operating pressure [bar]	Max. tightening torque for assembly [Nm]		
	2, 4	1, 3, 5	1 2/14, 8 2/84				Valve	DIN rail	Wall
	G1/4	G3/8	M5	2	Wrought aluminium alloy	-0.9 ... 10	0.65	1.5	3

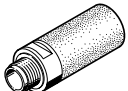

- 1) Blanking plugs are included with the manifold rail.
- 2) Corrosion resistance class CRC 2 to Festo standard FN 940070
Moderate corrosion stress. Indoor applications in which condensation can occur. External visible parts with primarily decorative surface requirements that are in direct contact with a normal industrial environment.
- 3) Information on materials: RoHS-compliant.

Ordering data – Accessories				
	Description	Part no.	Type	
Cover plate Datasheets → Internet: vabb				
	For manifold rail 18W, Sub-base valves	including screws and seal	574482	VABB-L1-18
Separator Datasheets → Internet: vabd				
	For manifold rail 18W, Sub-base valves	Separator for pressure zones	574483	VABD-14-B
Supply plate Datasheets → Internet: vabf				
	For manifold rail 18W	including screws and seal	574481	VABF-L1-18-P3A4-G14
Seals Datasheets → Internet: vabd				
	For sub-base valves B18	Delivery quantity: 10 sets (each with 2 screws and 1 seal)	574480	VABD-L1-18B-S-G14

Accessories

Ordering data		Description	Part no.	Type
Silencer				Datasheets → Internet: u
	For M5 thread	Pack of 1	165003	UC-M5
	For M7 thread		161418	UC-M7
	For G1/8 thread	Pack of 50	534222	U-1/8-50
		1 pieces	161419	UC-1/8
	For G1/4 thread	20 pieces	534220	UC-1/4-20
534223			U-1/4-20	
Fittings				Datasheets → Internet: qs
	For tubing Ø 3 mm	10 pieces	133003	QSM-M5-3-I-R
	For tubing Ø 4 mm		133004	QSM-M5-4-I-R
	For tubing Ø 6 mm		133005	QSM-M5-6-I-R
	For tubing Ø 6 mm		133007	QSM-M7-6-I-R
	For tubing Ø 3 mm	10 pieces	153313	QSM-M5-3-I
	For tubing Ø 4 mm		153315	QSM-M5-4-I
	For tubing Ø 4 mm		153319	QSM-M7-4-I
	For tubing Ø 4 mm	10 pieces	186106	QS-G1/8-4-I
	For tubing Ø 6 mm		186107	QS-G1/8-6-I
	For tubing Ø 8 mm		186109	QS-G1/8-8-I
	For tubing Ø 8 mm	20 pieces	130995	QS-B-1/4-8-I-20
	For tubing Ø 10 mm		132152	QS-B-1/4-10-I-20
	For tubing Ø 12 mm		132153	QS-B-1/4-12-I-20
	For tubing Ø 10 mm		132151	QS-B-1/8-10-I-20
	For tubing Ø 6 mm	10 pieces	186117	QSL-G1/8-6
	For tubing Ø 8 mm		186119	QSL-G1/8-8
	For tubing Ø 8 mm	20 pieces	130931	QSL-B-1/4-8-20
	For tubing Ø 10 mm		132127	QSL-B-1/4-10-20
	For tubing Ø 12 mm		132128	QSL-B-1/4-12-20
	For tubing Ø 10 mm		132126	QSL-B-1/8-10-20
	For tubing Ø 6 mm	10 pieces	186128	QSL-G1/8-6
	For tubing Ø 8 mm		186130	QSL-G1/8-8
	For tubing Ø 3 mm	10 pieces	153331	QSM-L-M5-3
	For tubing Ø 4 mm		153333	QSM-L-M5-4
	For tubing Ø 4 mm		186352	QSM-L-M7-4
	For tubing Ø 3 mm	10 pieces	130838	QSM-L-L-M5-3
	For tubing Ø 4 mm		153339	QSM-L-L-M5-4
	For tubing Ø 4 mm		186354	QSM-L-L-M7-4
	For tubing Ø 4 mm			
	Blanking plug			
	For M5 thread	Pack of 10	174308	B-M5-B
	For M7 thread		174309	B-M7
	For G1/8 thread		3568	B-1/8
	For G1/4 thread		3569	B-1/4
Compact blanking plug, for valve				Datasheets → Internet: b
	For sealing a connection (valve requires a blanking plug with a low screw-in depth)	For valve size 14 (G1/8), 10 pieces	578406	NPQH-BK-G18-P10
		For valve size 18 (G1/4), 10 pieces	578407	NPQH-BK-G14-P10

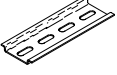
Accessories

Ordering data		Description	Part no.	Type		
DIN rail Datasheets → Internet: nrh						
	To EN 60715, 35 x 7.5 (WxH)	2 m	35430	NRH-35-2000		
DIN rail mounting Datasheets → Internet: vame						
	–	2 pieces	569998	VAMET-M4		
Flow control valve						
	For M5 valves, for setting the flow rate during pressurisation and exhausting (10 pieces)	Flow rate: 9.6 l/min	b value: 0.5	C value: 0.04	8025709	VFFG-T-M5-5
		Flow rate: 14.6 l/min	b value: 0.5	C value: 0.05	8025710	VFFG-T-M5-6
		Flow rate: 19.1 l/min	b value: 0.5	C value: 0.07	8025711	VFFG-T-M5-7
		Flow rate: 26.1 l/min	b value: 0.5	C value: 0.10	8025712	VFFG-T-M5-8
		Flow rate: 40.8 l/min	b value: 0.5	C value: 0.14	8025713	VFFG-T-M5-10
		Flow rate: 45.4 l/min	b value: 0.5	C value: 0.16	8025714	VFFG-T-M5-12
		Flow rate: 67.4 l/min	b value: 0.5	C value: 0.25	8025715	VFFG-T-M5-15