

# Solenoid valves VUVS/valve manifold assembly VTUS, NPT

**FESTO**

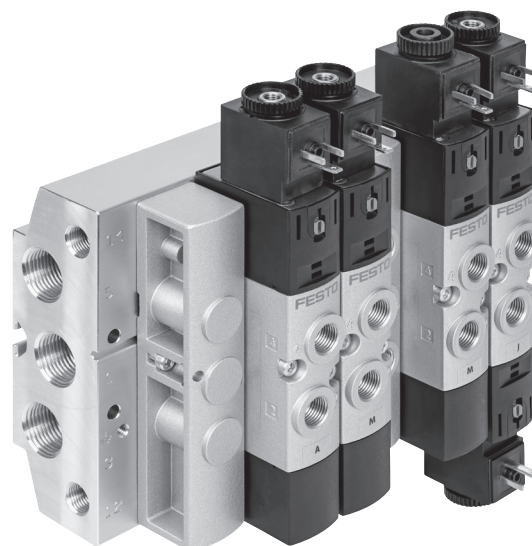

## Key features

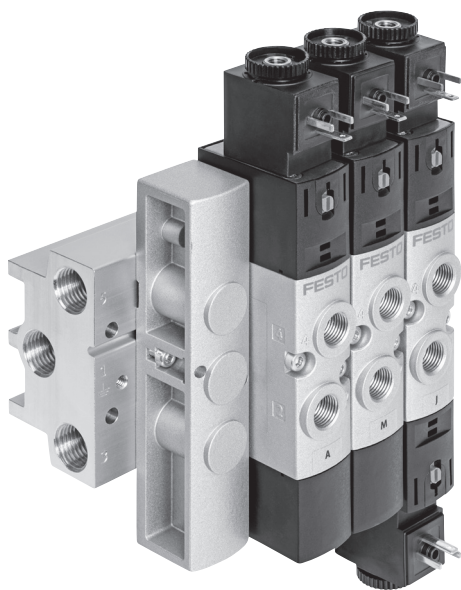

### Innovative

- A reliable, sturdy valve with a long service life
- Design principle:
  - Poppet seat, soft-sealing (VUVS-LT)
  - Piston spool with sealing cartridge (VUVS-L)
- Flow rate up to 1800 l/min with VUVS-LT
- Flow rate up to 2300 l/min with VUVS-L
- Wide range of valve functions

### Versatile

- Operating voltage can be easily altered by changing the solenoid coil
- In-line valves can be used as individual valves or manifold valves
- Flexible pressure zones
- Wide range of mounting options

### Reliable

- Ergonomic and safe operation
- Reliable servicing thanks to valves that can be replaced quickly and easily

### Easy to install

- Pre-assembled units on rails
- Individual valves assembled ready for installation
- Common supply manifolds for mounting on both sides
- Solid wall mounting or DIN rail mounting

### Ordering data – Product options

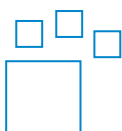

Configurable product  
This product and all its product options can be ordered using the configurator.

The configurator can be found at  
→ [www.festo.com/catalogue/...](http://www.festo.com/catalogue/...)  
Enter the part number or the type.

Part no.	Type
576516	VUVS-20
8022014	VUVS-25
8022017	VUVS-30
577304	VTUS-20
8022016	VTUS-25
8022019	VTUS-30

## Key features

### Solenoid valves VUVS

In-line valve VUVS-L as individual valve (piston spool valve)

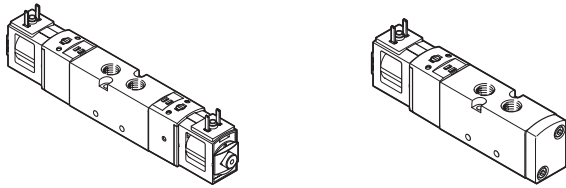

In-line valve VUVS-LT as individual valve (poppet valve)

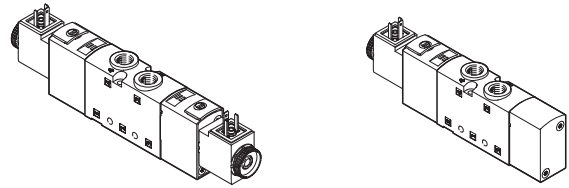

In-line valves are designed to be used without common pneumatic links. All pneumatic connections are on the valve and can be equipped with fittings/tubing. By using a special seal set, the in-line valves can also be

mounted on a manifold rail (pneumatic links) as semi in-line valves.

### VTUS valve manifold assembly

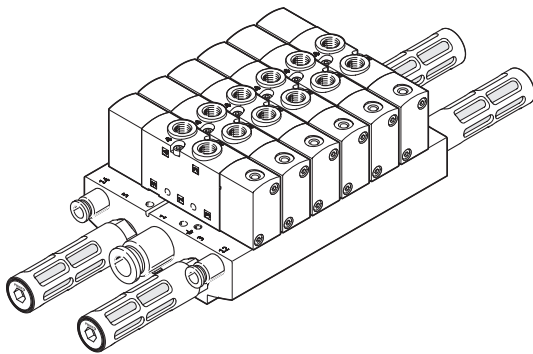

## Key features

### Equipment options

VUVS-LT

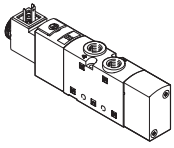

- 3/2-, 2x 3/2- and 5/2-way valves, with or without solenoid coil
- Size 20 (21 mm), size 25 (26.5 mm) and size 30 (31 mm)

### Valve functions

3/2-way valve, normally open, single solenoid:

- Internal/external pilot air supply
- Mechanical spring return
- Flow direction not reversible

3/2-way valve, normally closed, single solenoid:

- Internal/external pilot air supply
- Mechanical spring return
- flow direction not reversible

2x 3/2-way valve, normally open, single solenoid:

- Internal/external pilot air supply
- Mechanical spring return
- Flow direction not reversible

2x 3/2-way valve, normally closed, single solenoid:

- Internal/external pilot air supply
- Mechanical spring return
- Flow direction not reversible

2x 3/2-way valve, 1x normally open, 1x normally closed, single solenoid:

- Internal/external pilot air supply
- Mechanical spring return
- Flow direction not reversible

5/2-way valve, single solenoid

- Internal/external pilot air supply
- Mechanical spring return
- Flow direction not reversible

5/2-way valve, double solenoid

- Internal/external pilot air supply
- Flow direction not reversible

## Key features

## Equipment options

## VUVS-L

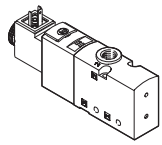

- 3/2-, 5/2- and 5/3-way valves, with or without solenoid coil
- Size 20 (21 mm), size 25 (26.5 mm) and size 30 (31 mm)

## Valve functions

3/2-way valve, normally open, single solenoid:

- Internal/external pilot air supply
- Pneumatic/mechanical spring return
- Flow direction can be reversed when using external pilot air supply

3/2-way valve, normally closed, single solenoid:

- Internal/external pilot air supply
- Pneumatic/mechanical spring return
- Flow direction can be reversed when using external pilot air supply

5/2-way valve, single solenoid

- Internal/external pilot air supply
- Pneumatic/mechanical spring return
- Flow direction can be reversed when using external pilot air supply

5/2-way valve, double solenoid

- Internal/external pilot air supply
- Flow direction can be reversed when using external pilot air supply

5/3-way valve, mid-position exhausted, pressurised or closed:

- Internal/external pilot air supply
- Mechanical spring return
- Flow direction can be reversed when using external pilot air supply

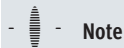

## Note

The operating voltage of valves VUVS-L and VUVS-LT can be varied by changing the solenoid coil on the armature tube.

## Key features

- A maximum of 16 valve positions can be configured in the standard version
- A maximum of 12 valve positions can be configured in the compact version
- Valve positions 2 ... 10 in increments of 1, valve positions 10 ... 16 in increments of 2
- Manifold block with a maximum of 10 valve positions
- Common supply manifold with a maximum of 10 valve positions
- Creation of pressure zones (maximum 9 pressure zones for a valve manifold assembly with 16 valve positions)

## Design

## Replacing valves

Each valve is attached to the manifold block using two screws. The appropriate seal is mounted on the valve.

This means that the valves can be easily replaced.

## Extension

Valve positions covered with cover plates can be replaced with valves at a later date. The dimensions, mounting points and existing pneumatic

installation remain unchanged.

## Key features

### Standard manifold block

For 3/2-way valves

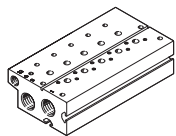

- Connection  
Size 20: 3/8 NPT  
Size 25: 1/2 NPT  
Size 30: 3/4 NPT
- For valves with external pilot air supply
- Maximum 10 valve positions

For 5/2-way and 5/3-way valves

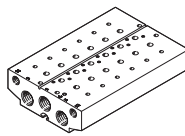

- Connection  
Size 20: 3/8 NPT  
Size 25: 1/2 NPT  
Size 30: 3/4 NPT
- For valves with external pilot air supply
- Maximum 10 valve positions

### Compact manifold block

For 3/2-way valves

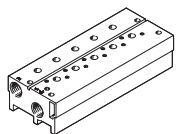

- Connection  
Size 20: 1/4 NPT  
Size 25: 3/8 NPT  
Size 30: 1/2 NPT
- Maximum 10 valve positions

For 5/2-way and 5/3-way valves

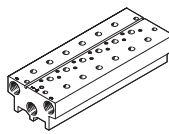

- Connection  
Size 20: 1/4 NPT  
Size 25: 3/8 NPT  
Size 30: 1/2 NPT
- Maximum 10 valve positions

### Common supply manifold

Mounting on both sides

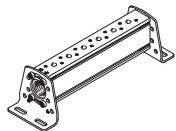

- Connection  
Size 20: 3/8 NPT  
Size 25: 1/2 NPT  
Size 30: 3/4 NPT
- Maximum 10 valve positions

### Cover plate for vacant position

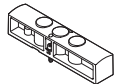

For covering vacant valve positions

### Supply plate

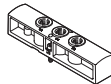

For additional air supply and exhaust via a valve position

### Separator for pressure zones



For creating pressure zones (maximum 9 pressure zones permitted)

### Note

A filter must be installed upstream of valves operated in vacuum mode. This prevents any foreign matter in the intake air getting into the valve (e.g. when operating a suction cup).

## Key features – Pneumatic components

## Creating pressure zones and separating exhaust air

Compressed air is supplied and exhausted via the manifold block/common supply manifold and via supply plates.

The position of the supply plates and duct separations can be freely selected with the VTUS.

A pressure zone is created by isolating the internal ducts between the valve positions with an appropriate separator.

The separator can be used in the following ducts:

- Duct 1
- Duct 3
- Duct 5

**Note**

- Use a separator if the exhaust air pressures are high
- Use at least one supply plate/air supply for each pressure zone
- Pressure zone separation is not possible in ducts 12 and 14 (pilot air supply)

Duct separation	Description	
	<p>The pressure zones can be freely configured with the VTUS. The following duct separations are possible:</p>	
	<ul style="list-style-type: none"> <li>• Duct 1 closed</li> </ul>	
	<ul style="list-style-type: none"> <li>• Duct 1/3/5 closed</li> </ul>	
	<ul style="list-style-type: none"> <li>• Duct 3/5 closed</li> </ul>	
	<p>The number of pressure zones with the VTUS is limited by the number of valve positions on the manifold block/common supply manifold. Note that each supply plate occupies one valve position. There must always be at least two valve positions between two separators. In the case of a maximum extension of 16 valve positions, a maximum of 9 pressure zones can be created.</p>	

## Key features – Pneumatic components, VUVS-LT

### Size 20 – Standard nominal flow rate $q_{nN}$ , with several valves $n$ switched in parallel

For 3/2-way valves

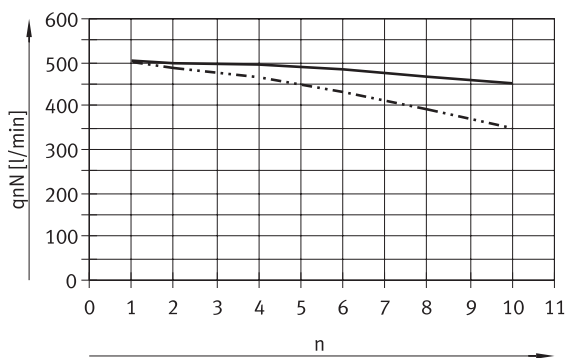

- Standard nominal flow rate per valve on manifold rail Standard
- - - Standard nominal flow rate per valve on manifold rail Compact

For 5/2-way valves, flow direction 1 → 2

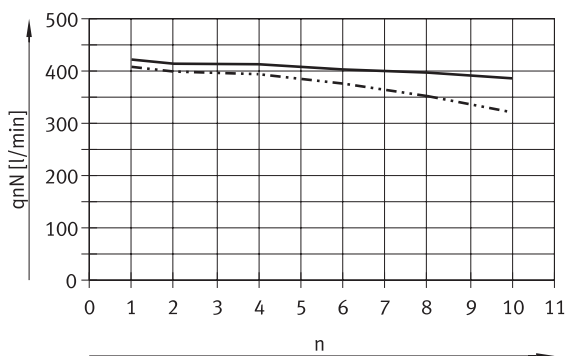

- Standard nominal flow rate per valve on manifold rail Standard
- - - Standard nominal flow rate per valve on manifold rail Compact

For 5/2-way valves, flow direction 1 → 4

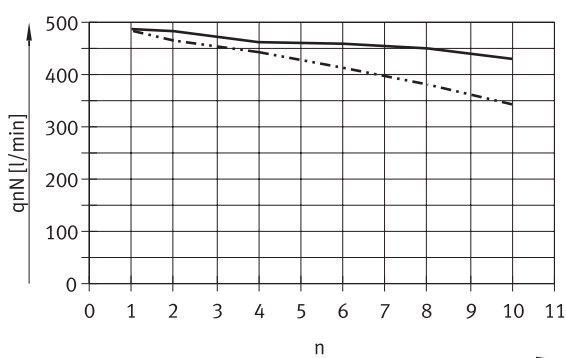

- Standard nominal flow rate per valve on manifold rail Standard
- - - Standard nominal flow rate per valve on manifold rail Compact



## Key features – Pneumatic components, VUVS-LT

### Size 20 – Standard nominal flow rate $q_{nN}$ , with several valves $n$ switched in parallel

For 2x 3/2-way valves

One valve function per valve position in open switching position

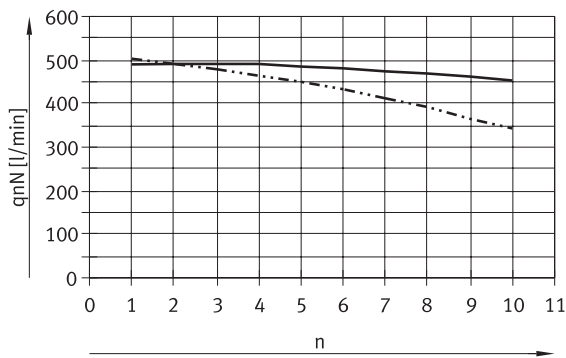

- Standard nominal flow rate per valve on manifold rail Standard
- - - Standard nominal flow rate per valve on manifold rail Compact

For 2x 3/2-way valves

Both valve functions per valve position simultaneously in open switching position

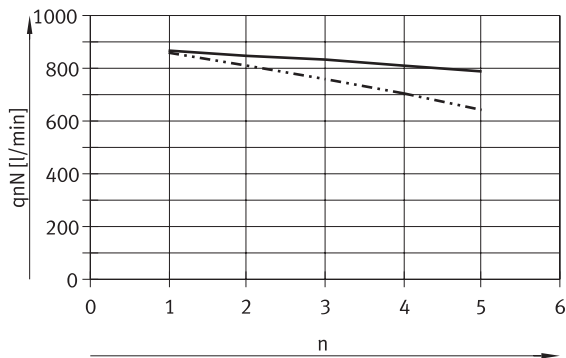

- Standard nominal flow rate per valve on manifold rail Standard
- - - Standard nominal flow rate per valve on manifold rail Compact

Key features – Pneumatic components, VUVS-LT

Size 25 – Standard nominal flow rate  $q_{nN}$ , with several valves  $n$  switched in parallel

For 3/2-way valves

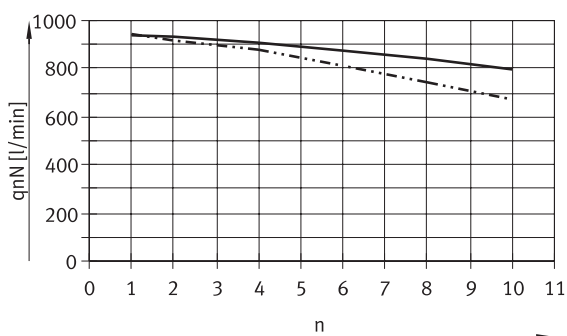

- Standard nominal flow rate per valve on manifold rail Standard
- - - Standard nominal flow rate per valve on manifold rail Compact

For 5/2-way valves, flow direction 1 → 2

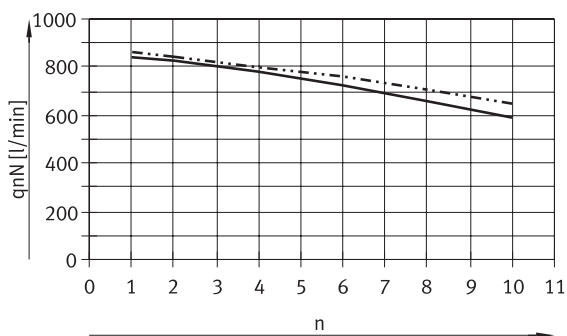

- Standard nominal flow rate per valve on manifold rail Standard
- - - Standard nominal flow rate per valve on manifold rail Compact

For 5/2-way valves, flow direction 1 → 4

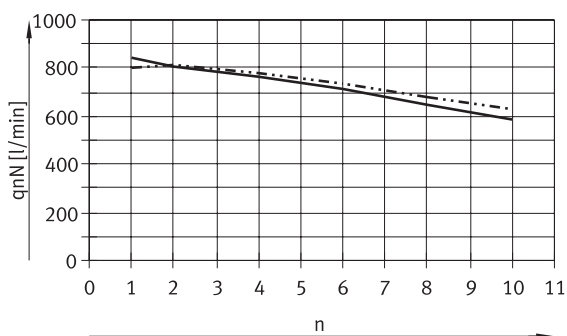

- Standard nominal flow rate per valve on manifold rail Standard
- - - Standard nominal flow rate per valve on manifold rail Compact

## Key features – Pneumatic components, VUVS-LT

### Size 25 – Standard nominal flow rate $q_{nN}$ , with several valves $n$ switched in parallel

For 2x 3/2-way valves

One valve function per valve position in open switching position

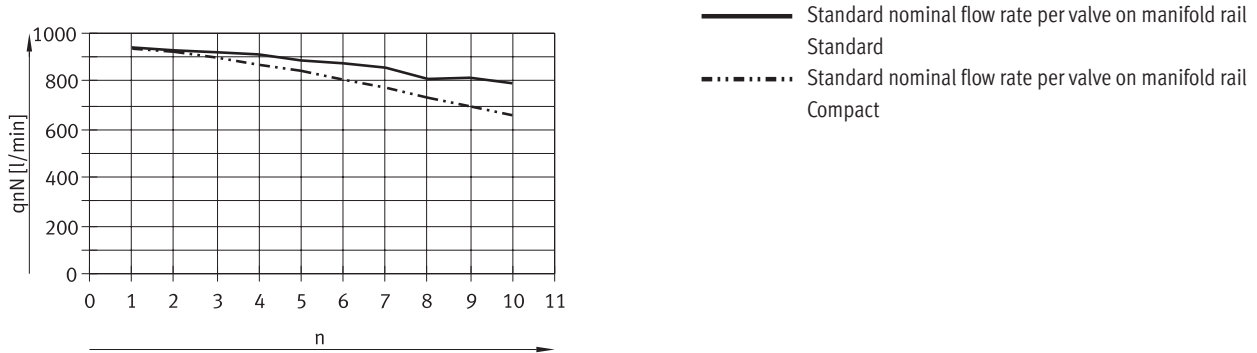

For 2x 3/2-way valves

Both valve functions per valve position simultaneously in open switching position

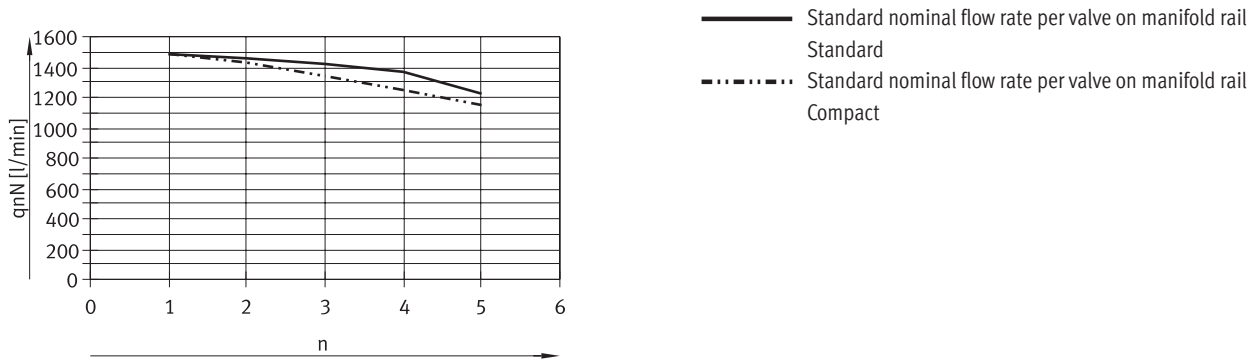

## Key features – Pneumatic components, VUVS-LT

### Size 30 – Standard nominal flow rate $q_{nN}$ , with several valves $n$ switched in parallel

For 3/2-way valves

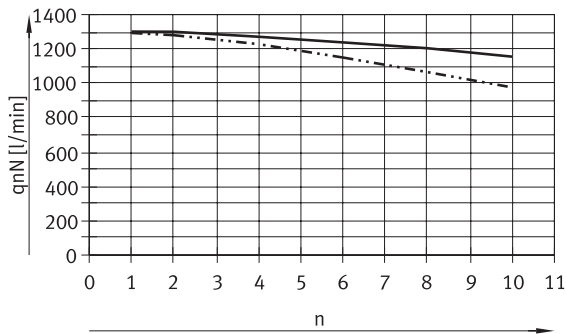

- Standard nominal flow rate per valve on manifold rail Standard
- - - Standard nominal flow rate per valve on manifold rail Compact

For 5/2-way valves, flow direction 1 → 2

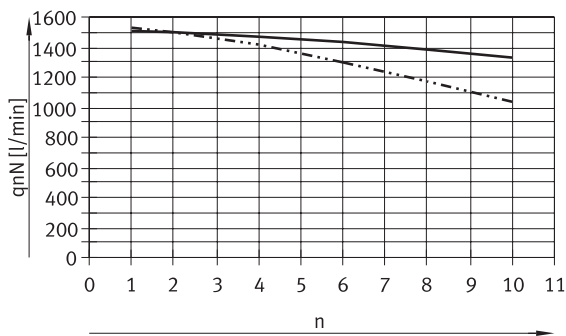

- Standard nominal flow rate per valve on manifold rail Standard
- - - Standard nominal flow rate per valve on manifold rail Compact

For 5/2-way valves, flow direction 1 → 4

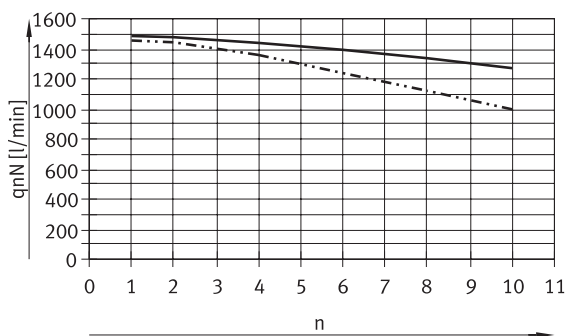

- Standard nominal flow rate per valve on manifold rail Standard
- - - Standard nominal flow rate per valve on manifold rail Compact

## Key features – Pneumatic components, VUVS-LT

### Size 30 – Standard nominal flow rate $q_{nN}$ , with several valves $n$ switched in parallel

For 2x 3/2-way valves

One valve function per valve position in open switching position

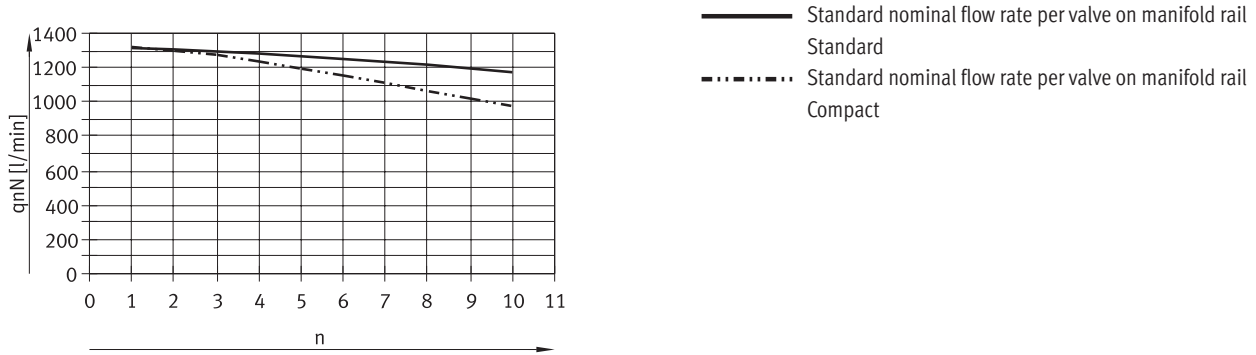

For 2x 3/2-way valves

Both valve functions per valve position simultaneously in open switching position

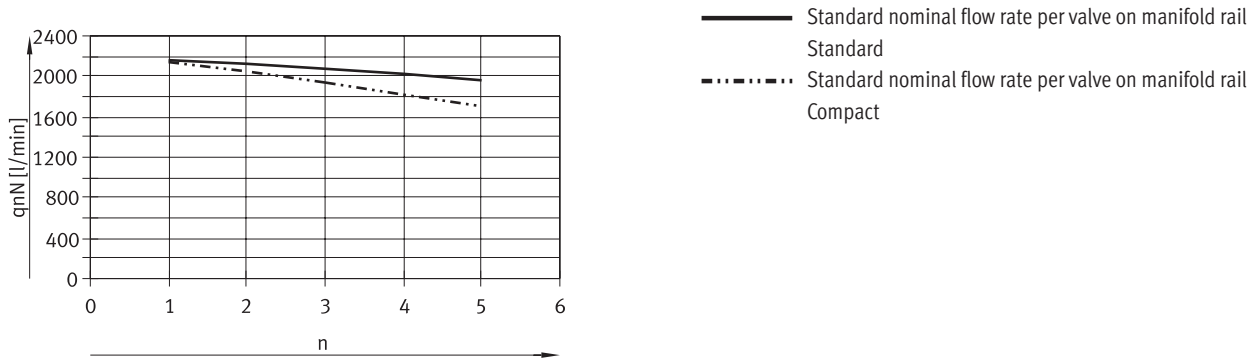

Key features – Pneumatic components, VUVS-L

**Size 20 – Standard nominal flow rate  $q_{nN}$ , with several valves  $n$  switched in parallel**

For 3/2-way valves

For 5/2- and 5/3-way valves

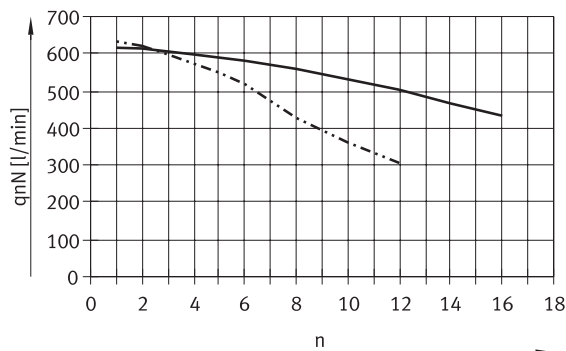
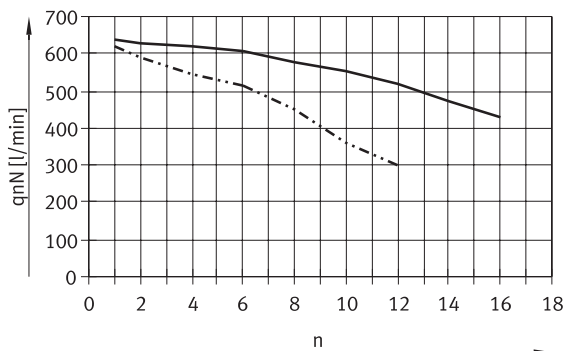

- Standard nominal flow rate per valve on manifold rail Standard
- - - Standard nominal flow rate per valve on manifold rail Compact

- Standard nominal flow rate per valve on manifold rail Standard
- - - Standard nominal flow rate per valve on manifold rail Compact

**Size 25 – Standard nominal flow rate  $q_{nN}$ , with several valves  $n$  switched in parallel**

For 3/2-way valves

For 5/2- and 5/3-way valves

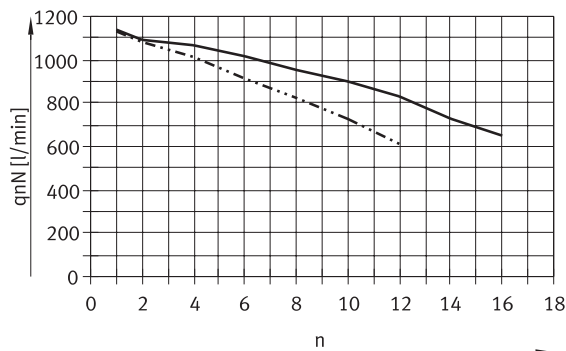
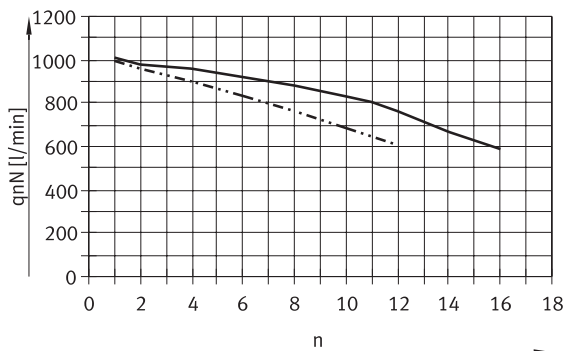

- Standard nominal flow rate per valve on manifold rail Standard
- - - Standard nominal flow rate per valve on manifold rail Compact

- Standard nominal flow rate per valve on manifold rail Standard
- - - Standard nominal flow rate per valve on manifold rail Compact

Key features – Pneumatic components, VUVS-L

**Size 30 – Standard nominal flow rate  $q_{nN}$ , with several valves  $n$  switched in parallel**

For 3/2-way valves

For 5/2- and 5/3-way valves

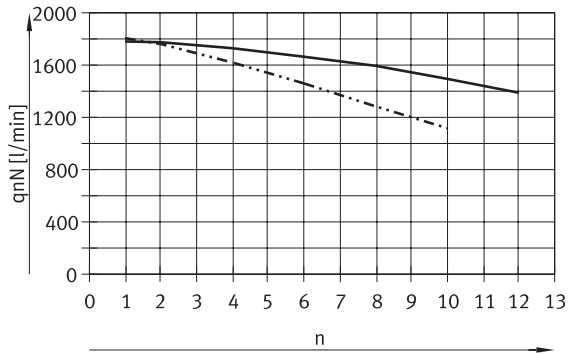

- Standard nominal flow rate per valve on manifold rail Standard
- · - · - Standard nominal flow rate per valve on manifold rail Compact

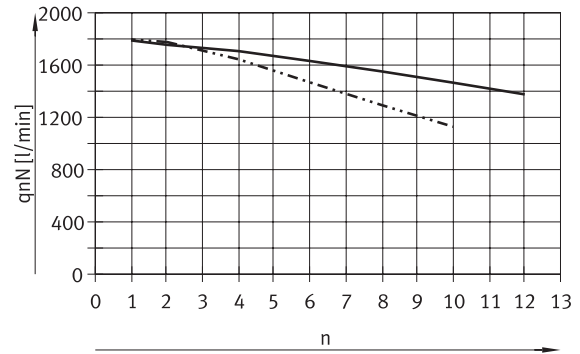

- Standard nominal flow rate per valve on manifold rail Standard
- · - · - Standard nominal flow rate per valve on manifold rail Compact

Key features – Pneumatic components, VUVS-LT

Size 20 – Pilot pressure  $p_2$  as a function of working pressure  $p_1$  with external pilot air supply

For 3/2-way valves

For 5/2-way valves, single solenoid

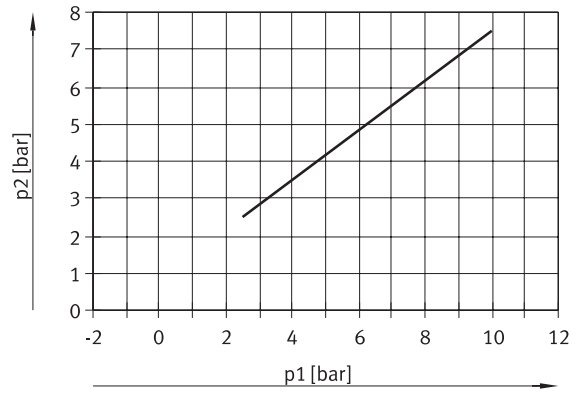
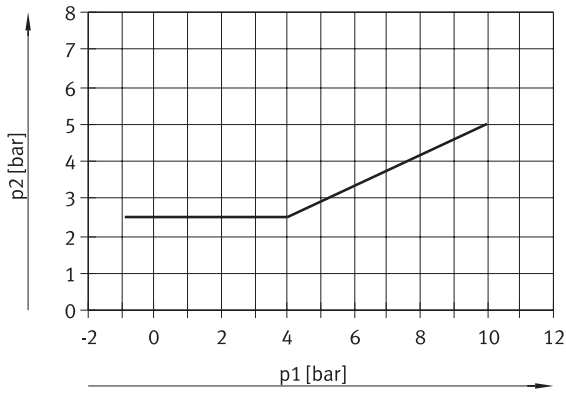

For 5/2-way valves, double solenoid

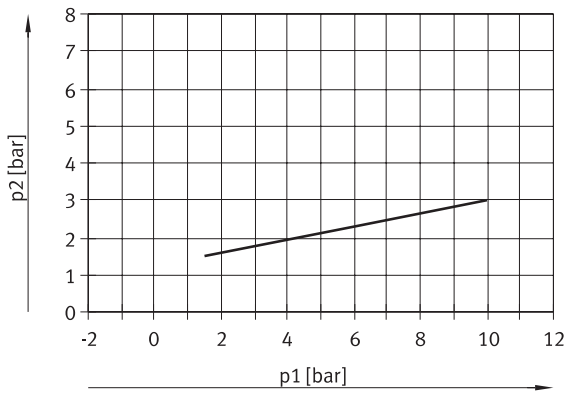



## Key features – Pneumatic components, VUVS-LT

Size 25 – Pilot pressure  $p_2$  as a function of working pressure  $p_1$  with external pilot air supply

For 3/2-way valves

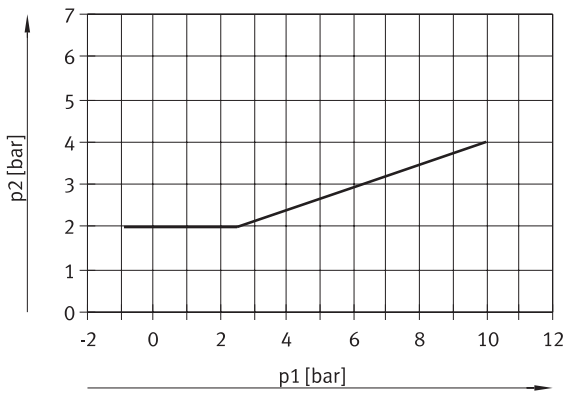

For 5/2-way valves, single solenoid

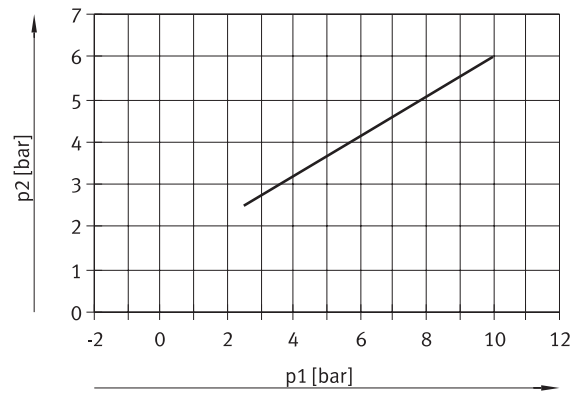

For 5/2-way valves, double solenoid

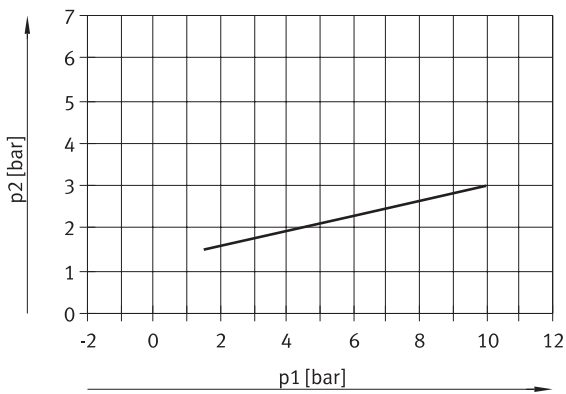

Key features – Pneumatic components, VUVS-LT

Size 30 – Pilot pressure p2 as a function of working pressure p1 with external pilot air supply

For 3/2-way valves

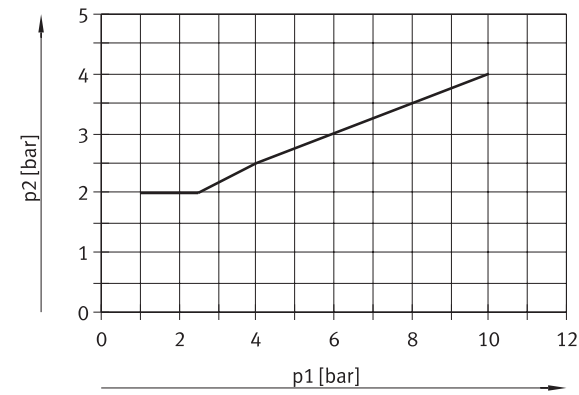

For 5/2-way valves, double solenoid

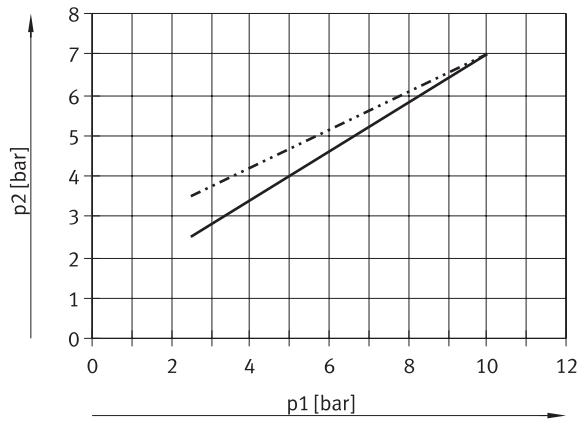

For 5/2-way valves, single solenoid

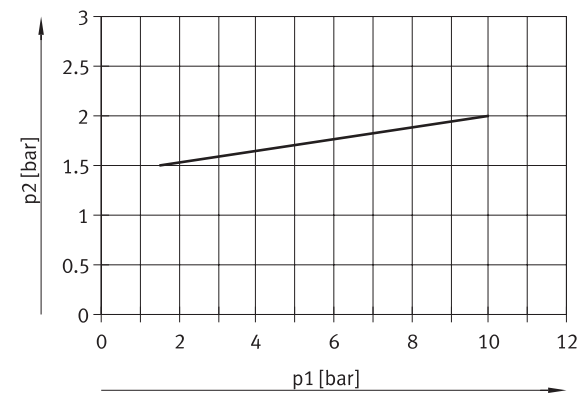

- VUVS-LT30-M52-MZD (0-60 °C)
- - - VUVS-LT30-M52-MZD (-10-0 °C)

## Key features – Pneumatic components

## Mounting – Valve manifold assembly VTUS

Sturdy manifold assembly thanks to:

- Four through-holes for wall mounting
- DIN rail mounting



Use the thread M4/M5 provided on the manifold block for earthing the valve manifold assembly.

## Wall mounting

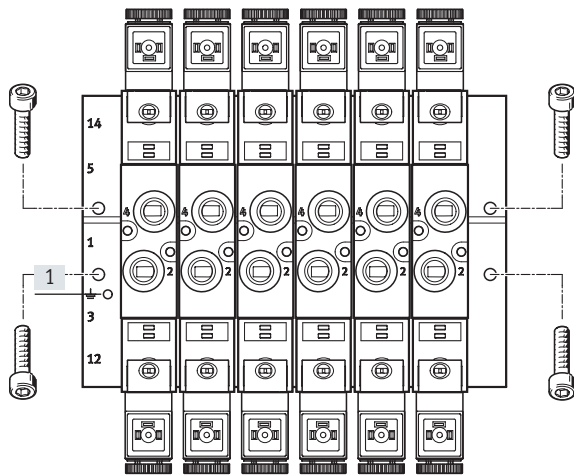

Sturdy wall mounting of the manifold block using four through-holes.

[1] Earth connection

## DIN rail mounting

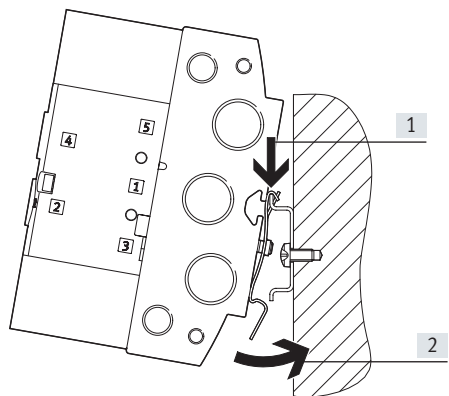

[1] Arrow A

[2] Arrow B

The DIN rail mounting VAME-T-M... consists of two mounting clips. These are screwed to the manifold block on the left and right.

The valve manifold assembly VTUS is then lowered onto the DIN rail from above (arrow A) and clipped into the DIN rail at the bottom (arrow B).



- Note the max. tightening torque of the screws for DIN rail mounting.
- Only horizontal DIN rail mounting permitted
- Mounting only permissible on DIN rail TH 35-... to EN 60715
- Vibration/shock loads are not permitted for DIN rail mounting.
- Additional note on assembly → Assembly instructions for DIN rail mounting VAME-T-M...

## Key features – Mounting

### Mounting – Individual valve VUVS

#### Wall mounting

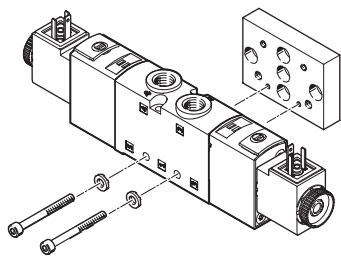

For mounting individual valves on a flat surface, e.g. aluminium profile systems.

The solenoid valves are provided with two through-holes for attaching to the wall mounting VAME-B10-20-W.

The relevant screw set is included when the wall mounting VAME-B10-20-W is ordered.

The wall mounting VAME-B10-20-W can be used for sizes 20, 25 and 30.

#### Foot mounting

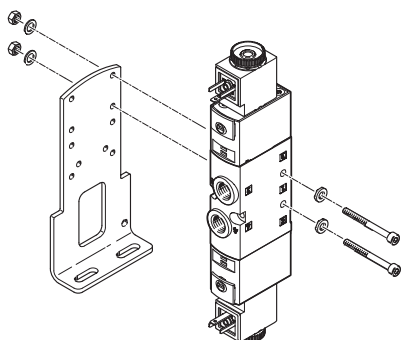

For mounting individual valves on a flat surface, e.g. aluminium profile systems.

The solenoid valves are provided with two through-holes for attaching to the foot mounting VAME-B10-...-A.

The relevant screw set is included when the foot mounting VAME-B10-...-A is ordered.

#### Note

Additional mounting options for foot mounting VAME-B10-...

→ Datasheet – Solenoid valves, dimensions

#### Cylinder mounting

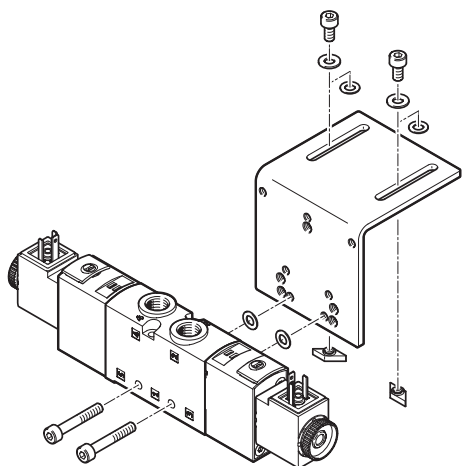

For mounting individual valves directly on a drive.

The solenoid valves are provided with two through-holes for attaching to the cylinder mounting DAVM-MW-V1...-V. Mounting is only possible on the side on which the pneumatic connections are located.

The relevant screw set is included when the cylinder mounting DAVM-MW-V1...-V is ordered.

## Product range overview

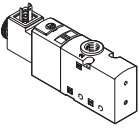
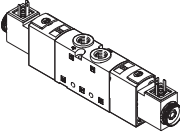
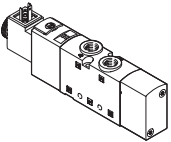
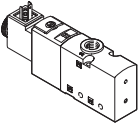
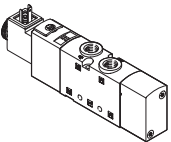
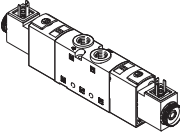
Valve	Size	Working port	Order code for valves and flow rate [l/min]										→ Page/Internet	
			M32C	M32U	T32C	T32U	T32H	M52	B52	P53C	P53U	P53E		
<b>3/2-way valve VUUS-LT</b>														
	20	1/8 NPT	■ 600	■ 600	-	-	-	-	-	-	-	-	-	44
	25	1/4 NPT	■ 1000	■ 1000	-	-	-	-	-	-	-	-	-	54
	30	3/8 NPT	■ 1600	■ 1600	-	-	-	-	-	-	-	-	-	65
<b>2x 3/2-way valve VUUS-LT</b>														
	20	1/8 NPT	-	-	■ 600	■ 600	■ 600	-	-	-	-	-	-	44
	25	1/4 NPT	-	-	■ 1000	■ 1000	■ 1000	-	-	-	-	-	-	54
	30	3/8 NPT	-	-	■ 1600	■ 1600	■ 1600	-	-	-	-	-	-	65
<b>5/2-way valve VUUS-LT</b>														
	20	1/8 NPT	-	-	-	-	-	■ 500	■ 500	-	-	-	-	44
	25	1/4 NPT	-	-	-	-	-	■ 1000	■ 1000	-	-	-	-	54
	30	3/8 NPT	-	-	-	-	-	■ 1800	■ 1800	-	-	-	-	65
<b>3/2-way valve VUUS-L</b>														
	20	1/8 NPT	■ 700	■ 700	-	-	-	-	-	-	-	-	-	76
	25	1/4 NPT	■ 1000	■ 1000	-	-	-	-	-	-	-	-	-	88
	30	3/8 NPT	■ 2300	■ 2300	-	-	-	-	-	-	-	-	-	100
<b>5/2-way valve VUUS-L</b>														
	20	1/8 NPT	-	-	-	-	-	■ 700	■ 700	-	-	-	-	76
	25	1/4 NPT	-	-	-	-	-	■ 1300	■ 1300	-	-	-	-	88
	30	3/8 NPT	-	-	-	-	-	■ 2300	■ 2300	-	-	-	-	100
<b>5/3-way valve VUUS-L</b>														
	20	1/8 NPT	-	-	-	-	-	-	-	■ 700	■ 600	■ 600	-	76
	25	1/4 NPT	-	-	-	-	-	-	-	■ 1200	■ 1000	■ 1000	-	88
	30	3/8 NPT	-	-	-	-	-	-	-	■ 2000	■ 1600	■ 1600	-	100

## Product range overview

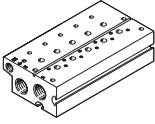
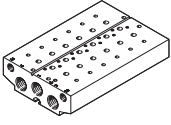
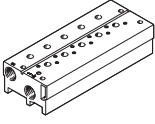
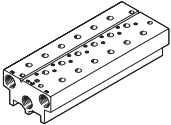
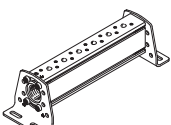
Design	Size	Description		→ Page/Internet
<b>Manifold block for 3/2-way valves, standard</b>				
	20	VABM-B10-20E-N38- ... P3	Connection size 3/8 NPT	112
	25	VABM-B10-25E-N12- ... P3	Connection size 1/2 NPT	122
	30	VABM-B10-30E-N34- ... P3	Connection size 3/4 NPT	132
<b>Manifold block for 5/2- and 5/3-way valves, standard</b>				
	20	VABM-B10-20E-N38- ...	Connection size 3/8 NPT	112
	25	VABM-B10-25E-N12- ...	Connection size 1/2 NPT	122
	30	VABM-B10-30E-N34- ...	Connection size 3/4 NPT	132
<b>Manifold block for 3/2-way valves, compact</b>				
	20	VABM-B10-20S-N14- ... P3	Connection size 1/4 NPT	112
	25	VABM-B10-25S-N38- ... P3	Connection size 3/8 NPT	122
	30	VABM-B10-30S-N12- ... P3	Connection size 1/2 NPT	132
<b>Manifold block for 5/2- and 5/3-way valves, compact</b>				
	20	VABM-B10-20S-N14- ...	Connection size 1/4 NPT	112
	25	VABM-B10-25S-N38- ...	Connection size 3/8 NPT	122
	30	VABM-B10-30S-N12- ...	Connection size 1/2 NPT	132
<b>Common supply manifold, for mounting on both sides</b>				
	20	VABM-B10-20-N38- ... -P53	Connection size 3/8 NPT	112
	25	VABM-B10-25-N12- ... -P53	Connection size 1/2 NPT	122
	30	VABM-B10-30-N34- ... -P53	Connection size 3/4 NPT	132

## Overview of valve functions

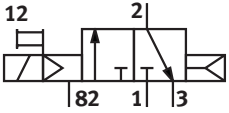
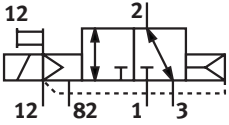
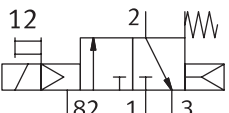
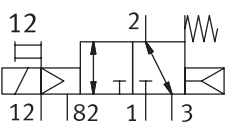
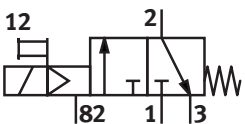
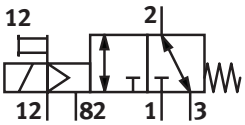
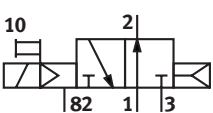
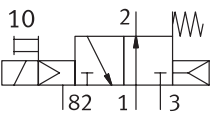
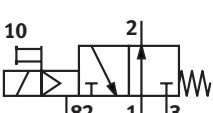

Valve	Order code for valves	Description	VUVS-LT			VUVS-L		
			Size			Size		
			20	25	30	20	25	30
<b>3/2-way valve, normally closed, pneumatic spring</b>								
	M32C-A	Internal pilot air supply, not reversible	-	-	-	■	■	■
		External pilot air supply, reversible	-	-	-	■	■	-
<b>3/2-way valve, normally closed, pneumatic/mechanical spring</b>								
	M32C-M	<ul style="list-style-type: none"> <li>Internal pilot air supply, not reversible</li> <li>Reset: mechanical spring, supported internally by pneumatic spring</li> </ul>	-	-	-	■	-	-
		<ul style="list-style-type: none"> <li>External pilot air supply, reversible</li> <li>Reset: mechanical spring, supported internally by pneumatic spring</li> </ul>	-	-	-	■	-	-
<b>3/2-way valve, normally closed, mechanical spring</b>								
	M32C-M	Internal pilot air supply, not reversible	■	■	■	■	■	■
		External pilot air supply, reversible	-	-	-	■	■	-
<b>3/2-way valve, normally open, pneumatic spring</b>								
	M32U-A	Internal pilot air supply, not reversible	-	-	-	■	■	■
<b>3/2-way valve, normally open, pneumatic/mechanical spring</b>								
	M32C-M	<ul style="list-style-type: none"> <li>Internal pilot air supply, not reversible</li> <li>Reset: mechanical spring, supported internally by pneumatic spring</li> </ul>	-	-	-	■	-	-
<b>3/2-way valve, normally open, mechanical spring</b>								
	M32U-M	Internal pilot air supply, not reversible	■	■	■	-	■	■

## Overview of valve functions

Valve	Order code for valves	Description	VUVS-LT			VUVS-L		
			Size			Size		
			20	25	30	20	25	30
<b>2x 3/2-way valve, normally closed, mechanical spring</b>								
	T32C	Internal pilot air supply, not reversible	■	■	■	-	-	-
<b>2x 3/2-way valve, normally open, mechanical spring</b>								
	T32U	Internal pilot air supply, not reversible	■	■	■	-	-	-
<b>2x 3/2-way valve, 1x normally open, 1x normally closed, mechanical spring</b>								
	T32H	Internal pilot air supply, not reversible	■	■	■	-	-	-

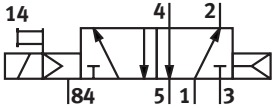
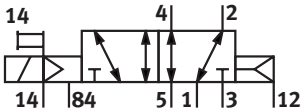
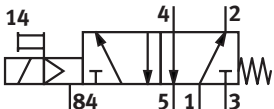

## Overview of valve functions

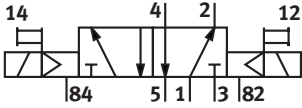
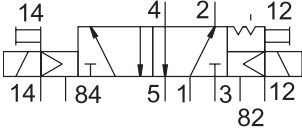
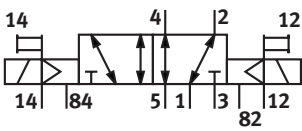
Valve	Order code for valves	Description	VUVS-LT			VUVS-L		
			Size			Size		
			20	25	30	20	25	30
<b>5/2-way valve, monostable, pneumatic spring</b>								
	M52-A	Internal pilot air supply, not reversible	-	-	-	■	■	■
	M52-AZ	External pilot air supply, reversible	-	-	-	■	■	-
<b>5/2-way valve, monostable, mechanical spring</b>								
	M52-M	Internal pilot air supply, not reversible	■	■	■	■	■	■
	M52-MZ	External pilot air supply, reversible	-	-	-	■	■	-
<b>5/2-way valve, double solenoid</b>								
	B52	Internal pilot air supply, not reversible	-	-	■	■	■	■
		<ul style="list-style-type: none"> <li>• Internal pilot air supply, not reversible</li> <li>• Holding the switching position via a latch</li> </ul>	■	■	-	-	-	-
	B52-Z	External pilot air supply, reversible	-	-	-	■	■	-

Overview of valve functions

Valve	Order code for valves	Description	VUVS-L		
			Size		
			20	25	30
<b>5/3-way valve, mechanical spring, closed</b>					
	P53C-M	Internal pilot air supply, not reversible	■	■	■
	P53C-MZ	External pilot air supply, reversible	■	■	-
<b>5/3-way valve, mechanical spring, pressurised</b>					
	P53U	Internal pilot air supply, not reversible	■	■	■
<b>5/3-way valve, mechanical spring, exhausted</b>					
	P53E	Internal pilot air supply, not reversible	■	■	■

## Peripherals overview VUVS-LT, VUVS-L

## Manifold block for 3/2-way valves

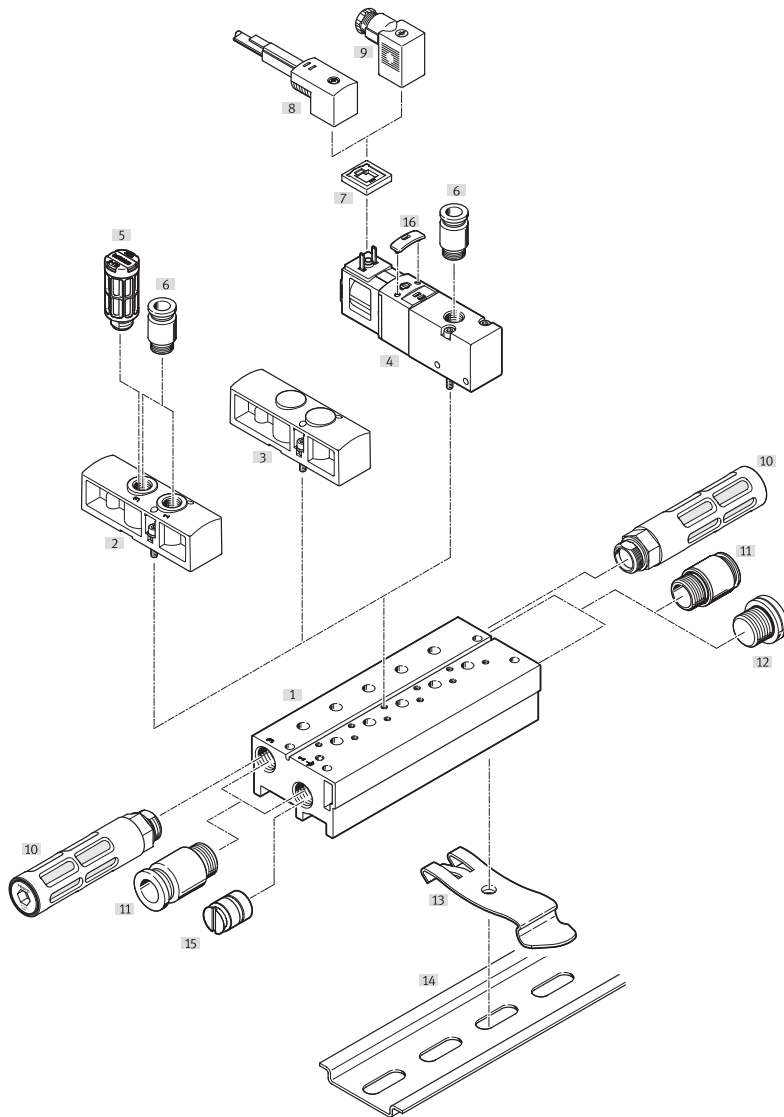

Designation	Description	→ Page/Internet
[1] Compact manifold block	For 3/2-way valves, no port for external pilot air supply	117
[2] Supply plate	For additional air supply and exhaust via a valve position	118
[3] Cover plate	For covering vacant valve positions	118
[4] Solenoid valve	3/2-way valve (without solenoid coil)	61
[5] Silencer	For port 3, exhaust	120
[6] Push-in fitting	For ports 1 and 3, supply and exhaust ports with supply plate, for port 2, working port, on the valve	118
[7] Illuminating seal	For indicating the switching status	86
[8] Plug socket with cable	For solenoid valves VUVS	86
[9] Plug socket	For solenoid valves VUVS	85
[10] Silencer	For port 3, exhaust	120
[11] Push-in fitting	For ports 1 and 3, supply and exhaust ports	118
[12] Blanking plug	For ports 1 and 3, supply and exhaust ports	121
[13] DIN rail mounting	For DIN rail mounting	121
[14] DIN rail	–	–
[15] Separator	For creating pressure zones in ports 1 and 3	121
[16] Cover cap	For manual override, non-detenting or covered	51

Peripherals overview VUVS-LT, VUVS-L

Manifold block for 5/2- and 5/3-way valves

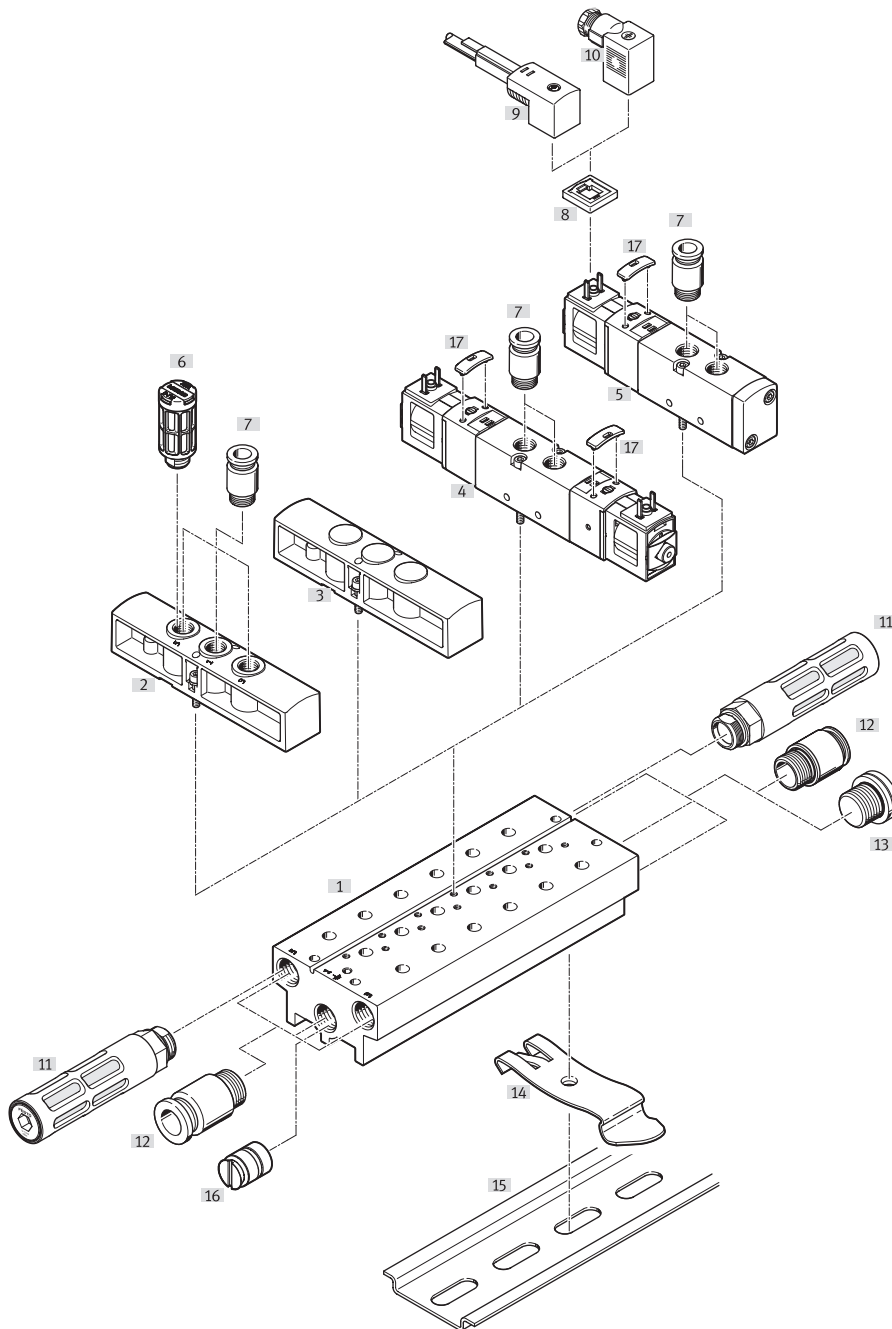

Designation	Description	→ Page/Internet
[1] Compact manifold block	For 5/2- and 5/3-way valves, no port for external pilot air supply	117
[2] Supply plate	For additional air supply and exhaust via a valve position	118
[3] Cover plate	For covering vacant valve positions	118
[4] Solenoid valve	5/3-way valve and 5/2-way valve, double solenoid (without solenoid coil)	61
[5] Solenoid valve	5/2-way valve, single solenoid (without solenoid coil)	61
[6] Silencer	For ports 3 and 5, exhaust	120
[7] Push-in fitting	For ports 1, 3 and 5, supply and exhaust ports with supply plate, for ports 2 and 4, working port, on the valve	118
[8] Illuminating seal	For indicating the switching status	86

## Peripherals overview VUVS-LT, VUVS-L

Designation	Description	→ Page/Internet
[9] Plug socket with cable	For solenoid valves VUVS	86
[10] Plug socket	For solenoid valves VUVS	85
[11] Silencer	For ports 3 and 5, exhaust	120
[12] Push-in fitting	For ports 1, 3 and 5, supply and exhaust ports	118
[13] Blanking plug	For ports 1, 3 and 5, supply and exhaust ports	121
[14] DIN rail mounting	For DIN rail mounting	121
[15] DIN rail	–	–
[16] Separator	For creating pressure zones in ports 1, 3 and 5	121
[17] Cover cap	For manual override, non-detenting or covered	51

Peripherals overview VUVS-LT, VUVS-L

Common supply manifold for mounting on both sides

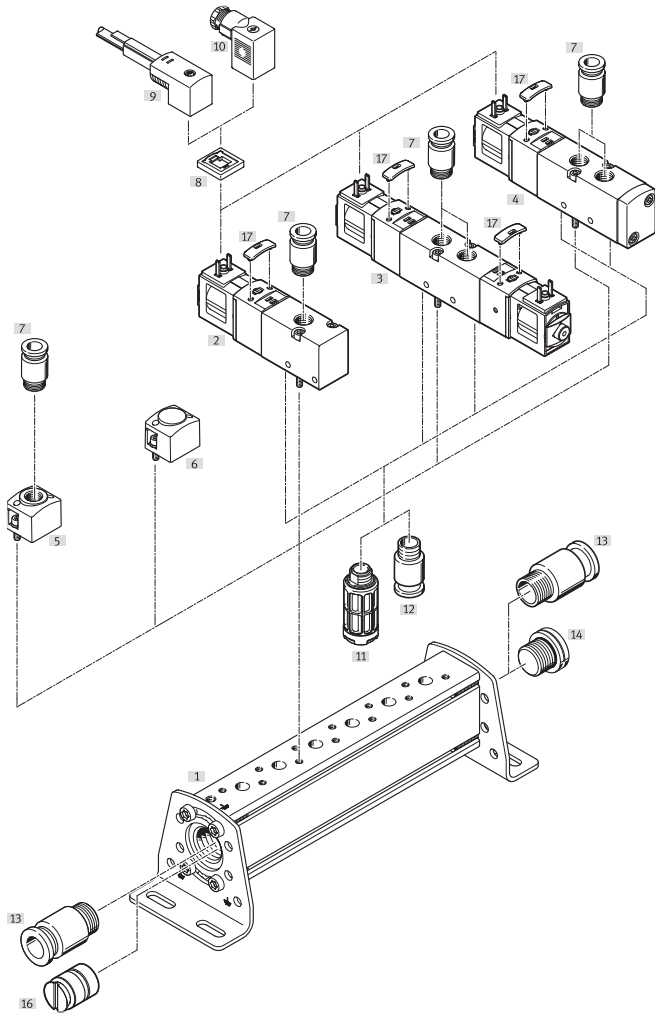

Designation	Description	→ Page/Internet
[1] Common supply manifold	–	117
[2] Solenoid valve	3/2-way valve (without solenoid coil)	61
[3] Solenoid valve	5/3-way valve and 5/2-way double solenoid valve (without solenoid coil) 2x 3/2-way valve (without solenoid coil)	61
[4] Solenoid valve	5/2-way valve, single solenoid (without solenoid coil)	84
[5] Supply plate	For additional air supply via a valve position	118
[6] Cover plate	For covering vacant valve positions	118
[7] Push-in fitting	For port 1, working port	118
[8] Illuminating seal	For indicating the switching status	86
[9] Plug socket with cable	For solenoid valves VUVS	86
[10] Plug socket	For solenoid valves VUVS	85
[11] Silencer	For ports 3 and 5, exhaust, on the valve	120
[12] Push-in fitting	For ports 3 and 5, exhaust, on the valve	118
[13] Push-in fitting	For port 1, supply port	118
[14] Blanking plug	For port 1, supply port	121
[16] Separator	For creating pressure zones	121
[17] Cover cap	For manual override, non-detenting or covered	51

## Datasheet – Valve manifold assembly

-  - Flow rate  
 Size 20:  
 up to 700 l/min  
 Size 25:  
 up to 1300 l/min  
 Size 30  
 up to 2300 l/min

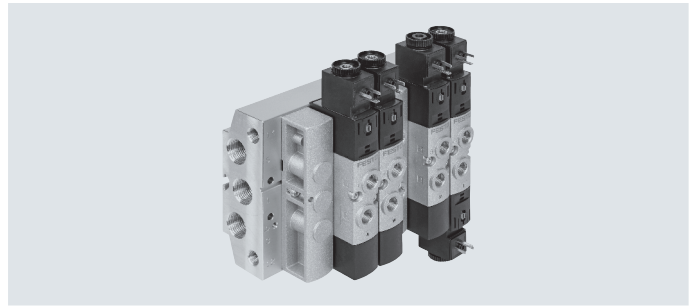

General technical data		20	25	30
Size		20	25	30
Valve manifold design		Fixed grid		
Valve width	[mm]	21	26.5	31
Valve design	VUVS-L	Piston spool with sealing cartridge		
	VUVS-LT	Poppet seat		
Electrical control		Individual connection		
Reset method for valves	VUVS-L	Pneumatic or mechanical spring		
	VUVS-LT	Mechanical spring		
Pilot air supply		Internal or external		
Flow direction	VUVS-L	Reversible with restrictions		
	VUVS-LT	Not reversible		
Suitable for vacuum	VUVS-L	Yes, with external pilot air supply		
	VUVS-LT	No		
Overlap	VUVS-L	Positive overlap		
	VUVS-LT	Negative overlap		
Sealing principle		Soft		
Max. number of valve positions		16 (a maximum of 18 valve positions with extension for standard manifold block)		
Max. no. of pressure zones		9		
Exhaust air function		Can be throttled		
Actuation type		Electrical		
Nominal operating voltage	[V DC]	12, 24		
	[V AC]	24, 110, 120, 230, 240		
Standard nominal flow rate qnN	[l/min]	500 ... 700	1000 ... 1300	1600 ... 2300
Pilot air connection	Standard manifold block	1 2/14	1/8 NPT	1/8 NPT
	Compact manifold block	1 2/14	On the valve	On the valve
	Common supply manifold	1 2/14	On the valve	On the valve
Pilot exhaust air port	8 2/84	10-32 UNF-2B		
Mounting position		Any		
Degree of protection		IP65, IP67		
		With plug socket, to IEC 60529		
Permissible voltage fluctuations	[%]	± 10		
<b>Materials</b>				
Seals	VUVS-L	HNBR, NBR		
	VUVS-LT	HNBR, NBR, TPE-U(PU)		
Note on materials		RoHS-compliant		

Datasheet – Valve manifold assembly

ATEX			
Size	20	25	30
ATEX category for gas	II 3G		
Type of (ignition) protection for gas	Ex ec IICT4 Gc X		
ATEX category for dust	II 3D		
Type of ignition protection for dust	Ex tc IIIC T115°C Dc X	Ex mb IIIC T80°C Db	Ex tc IIIC T115°C Dc X
Explosion-proof ambient temperature [°C]	-10 ≤ Ta ≤ +50		
CE marking (see declaration of conformity) <sup>1)</sup>	To EU Explosion Protection Directive (ATEX)		
UKCA marking (see declaration of conformity) <sup>1)</sup>	To UK explosion regulations		
Explosion protection certification outside the EU	EPL Dc (GB)		
	EPL Gc (GB)		
Certificate-issuing authority	–	DNV 15.0189X/02	–

1) For information about the area of use, see the declaration of conformity at: [www.festo.com/catalogue/...](http://www.festo.com/catalogue/...) → Support/Downloads.  
If the devices are subject to usage restrictions in residential, commercial or light-industrial environments, further measures for the reduction of the emitted interference may be necessary.

Operating and environmental conditions			
Valve design		Piston spool	Poppet seat
Operating medium		Compressed air to ISO 8573-1:2010 [7:4:4]	
Pilot medium		Compressed air to ISO 8573-1:2010 [7:4:4]	
Note on the operating/pilot medium		Lubricated operation possible (in which case lubricated operation will always be required)	
Cleanroom class		ISO class 6	
Operating pressure			
With external pilot air	[bar]	-0.9 ... +10	+1.5 ... +10 (B52) +2.5 ... +10 (M52)
With internal pilot air	[bar]	+1.5 ... +10 +2.5 ... +10 (M32...-A, M32...-M, M52-A)	+1.5 ... +10 (B52) +2.5 ... +10 (M52, M32, T32)
Pilot pressure	[bar]	+1.5 ... +10 (B52) +2.5 ... +10	+1.5 ... +10 (B52) +2.5 ... +10 (M52)
Ambient temperature	[°C]	-10 ... +60	-5 ... +60 (M32, T32) -10 ... +60 (B52, M52)
Temperature of medium	[°C]	-10 ... +60	-5 ... +60 (M32, T32) -10 ... +60 (B52, M52)
Certification		c UL us - Recognized (OL)	
Corrosion resistance class CRC <sup>1)</sup>		2	

1) More information [www.festo.com/x/topic/crc](http://www.festo.com/x/topic/crc)



## Datasheet – Valve manifold assembly

## Dimensions – Valve manifold assembly

Download CAD data → [www.festo.com](http://www.festo.com)

With 3/2-way valves, standard manifold block

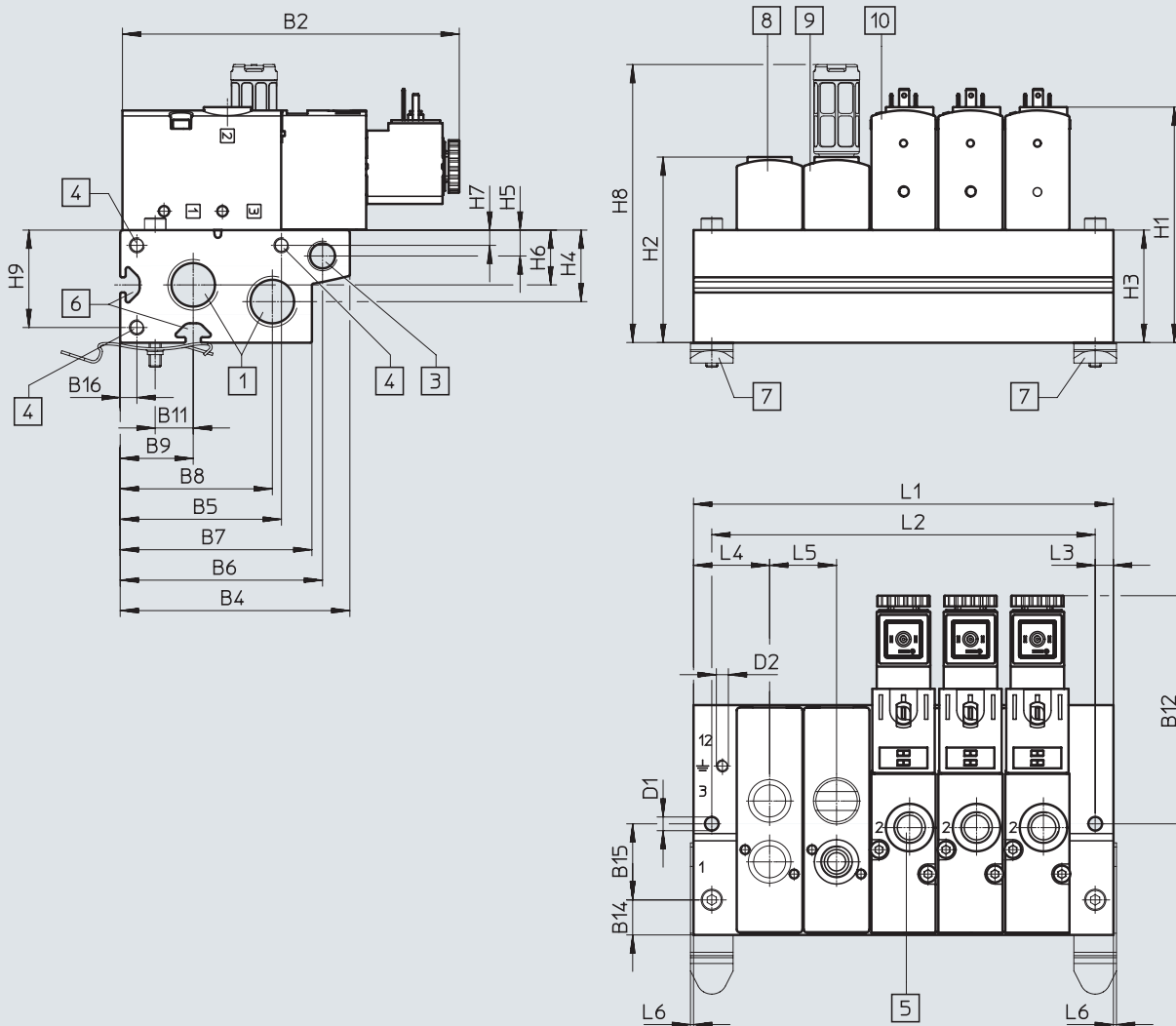

- |   |   |  |  |
|---|---|--|--|
| [1] Port 1 and 3<br>(on both sides):<br>3/8 NPT for VTUS-20<br>1/2 NPT for VTUS-25<br>3/4 NPT for VTUS-30 | [4] Thread for extension module:<br>M5x15.5 for VTUS-20<br>M5x18 for VTUS-25<br>M5x18 for VTUS-30 | [6] Profile slot IPM-05 system 5 for<br>VTUS-20 and VTUS-25, profile<br>slot IPM-08 system 8 for VTUS-<br>30 | [9] Supply plate,<br>port 1 and 3:<br>G1/8 for VTUS-20<br>G1/4 for VTUS-25<br>G3/8 for VTUS-30 |
| [3] Port 12 (on both sides): 1/8 NPT<br>for VTUS-20<br>1/8 NPT for VTUS-25<br>1/8 NPT for VTUS-30         | [5] Port 2:<br>1/8 NPT for VTUS-20<br>1/4 NPT for VTUS-25<br>3/8 NPT for VTUS-30                  | [7] DIN rail mounting VAME-T-M4 for<br>VTUS-20<br>VAME-T-M5 for VTUS-25<br>VAME-T-M6 for VTUS-30             | [10] 3/2-way valve   |
|   |   | [8] Cover plate  |  |

Datasheet – Valve manifold assembly

Type	B2	B4	B5	B6	B7	B8	B9	B11	B12	B14	B15	B16
VTUS-20	110.7	75.5	53	66.5	63	50	24	12.5	75	11.5	25	5.5
VTUS-25	129.2	93	67.5	80.5	78	62	30	16	84.2	14	32	6
VTUS-30	144.9	108.2	79	93.2	94.7	75.7	36.2	19	91.2	17.2	38	6.5

Type	D1 ø	D2	H1	H2	H3	H4	H5	H6	H7	H8	H9	L3	L4	L5	L6
VTUS-20	4.5	M4x6.5	77.4	61	37	23.5	8.5	18	5	91.4	32	6	25	22	1
VTUS-25	5.5	M4x9	95.5	71	45	25	9	22	5	123.4	39	6	29.8	27.5	1
VTUS-30	4.5	M5x11	118	91	61	35	9	28.5	6.5	170.1	54.5	7.5	34	32	–

Type	Valve positions	2	3	4	5	6	7	8	9	10
VTUS-20	L1 [mm]	72	94	116	138	160	182	204	226	248
	L2 [mm]	60	82	104	126	148	170	192	214	236
VTUS-25	L1 [mm]	87	114.5	142	169.5	197	224.5	252	279.5	307
	L2 [mm]	75	102.5	130	157.5	185	212.5	240	267.5	295
VTUS-30	L1 [mm]	100	132	164	196	228	260	292	324	356
	L2 [mm]	85	117	149	181	213	245	277	309	341

## Datasheet – Valve manifold assembly

### Dimensions – Valve manifold assembly

Download CAD data → [www.festo.com](http://www.festo.com)

With 3/2-way valves, compact manifold block

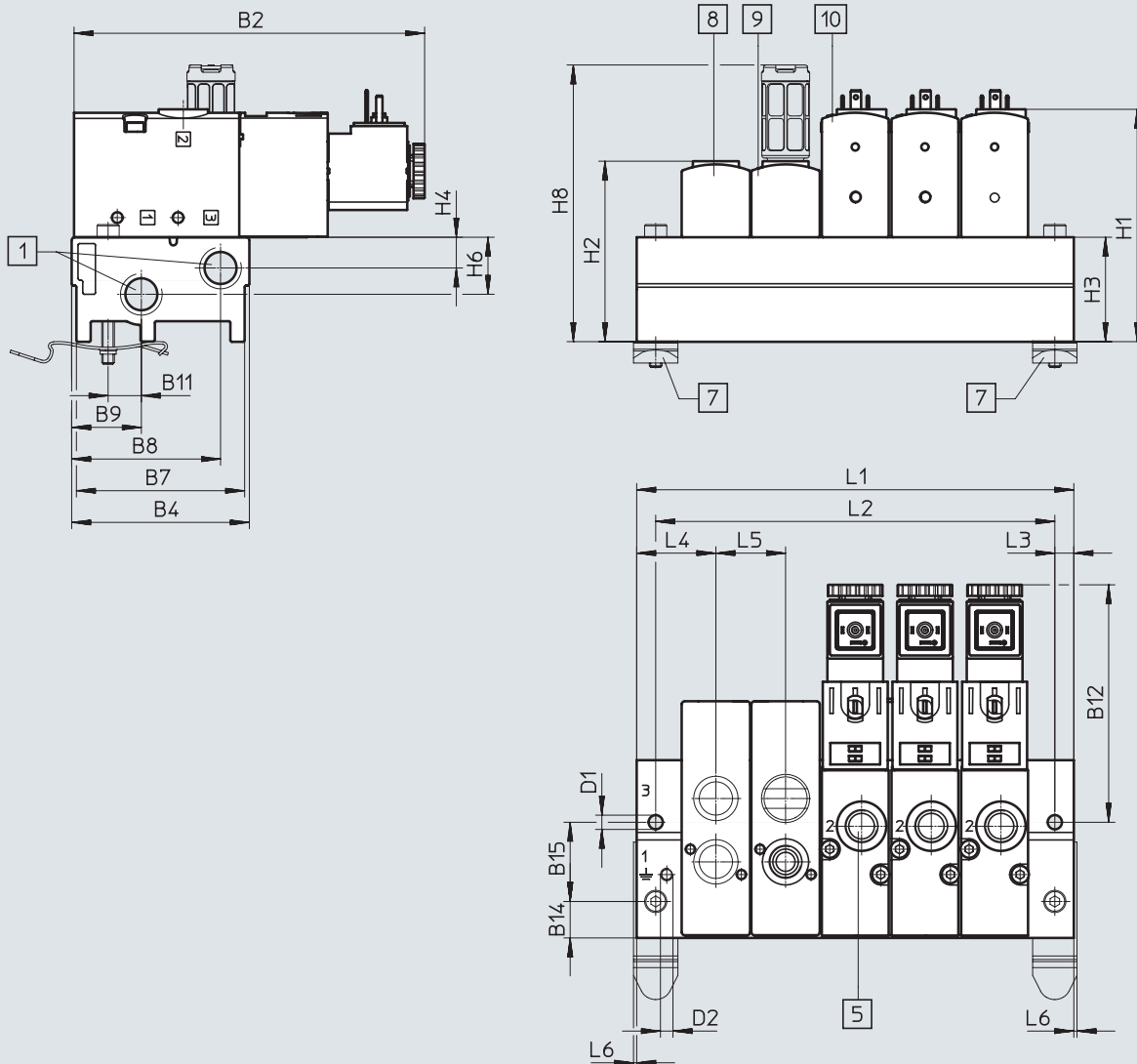

- |  |  |   |   |
|--|--|---|---|
| <p>[1] Port 1 and 3<br/>(on both sides):<br/>1/4 NPT for VTUS-20<br/>3/8 NPT for VTUS-25<br/>1/2 NPT for VTUS-30</p> | <p>[5] Port 2:<br/>1/8 NPT for VTUS-20<br/>1/4 NPT for VTUS-25<br/>3/8 NPT for VTUS-30</p> | <p>[7] DIN rail mounting VAME-T-M4 for VTUS-20<br/>VAME-T-M5 for VTUS-25<br/>VAME-T-M6 for VTUS-30</p> <p>[8] Cover plate</p> | <p>[9] Supply plate,<br/>port 1 and 3:<br/>G1/8 for VTUS-20<br/>G1/4 for VTUS-25<br/>G3/8 for VTUS-30</p> <p>[10] 3/2-way valve</p> |
|--|--|---|---|

Datasheet – Valve manifold assembly

Type	B2	B4	B7	B8	B9	B11	B12	B14	B15
VTUS-20	110.7	56.1	53.1	47	22	10.5	75	11.5	25
VTUS-25	129.2	70.3	67.3	58.8	30	16	84	14	32
VTUS-30	144.9	83	80	69.4	36	19	91.2	17	38

Type	D1 ø	D2	H1	H2	H3	H4	H6	H8	L3	L4	L5	L6
VTUS-20	4.5	M4x6.5	73.4	57	33	9.7	18	87.4	6	25	22	1
VTUS-25	5.5	M4x9	84.5	60	34	13.5	20	112.4	6	29.8	27.5	1
VTUS-30	6.3	M5x11	99.5	72.5	42.5	17.5	26	151.6	7.5	38	32	–

Type	Valve positions	2	3	4	5	6	7	8	9	10
VTUS-20	L1 [mm]	72	94	116	138	160	182	204	226	248
	L2 [mm]	60	82	104	126	148	170	192	214	236
VTUS-25	L1 [mm]	87	114.5	142	169.5	197	224.5	252	279.5	307
	L2 [mm]	75	102.5	130	157.5	185	212.5	240	267.5	295
VTUS-30	L1 [mm]	100	132	164	196	228	260	292	324	356
	L2 [mm]	85	117	149	181	213	245	277	309	341

## Datasheet – Valve manifold assembly

### Dimensions – Valve manifold assembly

Download CAD data → [www.festo.com/de/engineering](http://www.festo.com/de/engineering)

With 5/2-, 5/3-, and 2x 3/2-way valves, standard manifold block

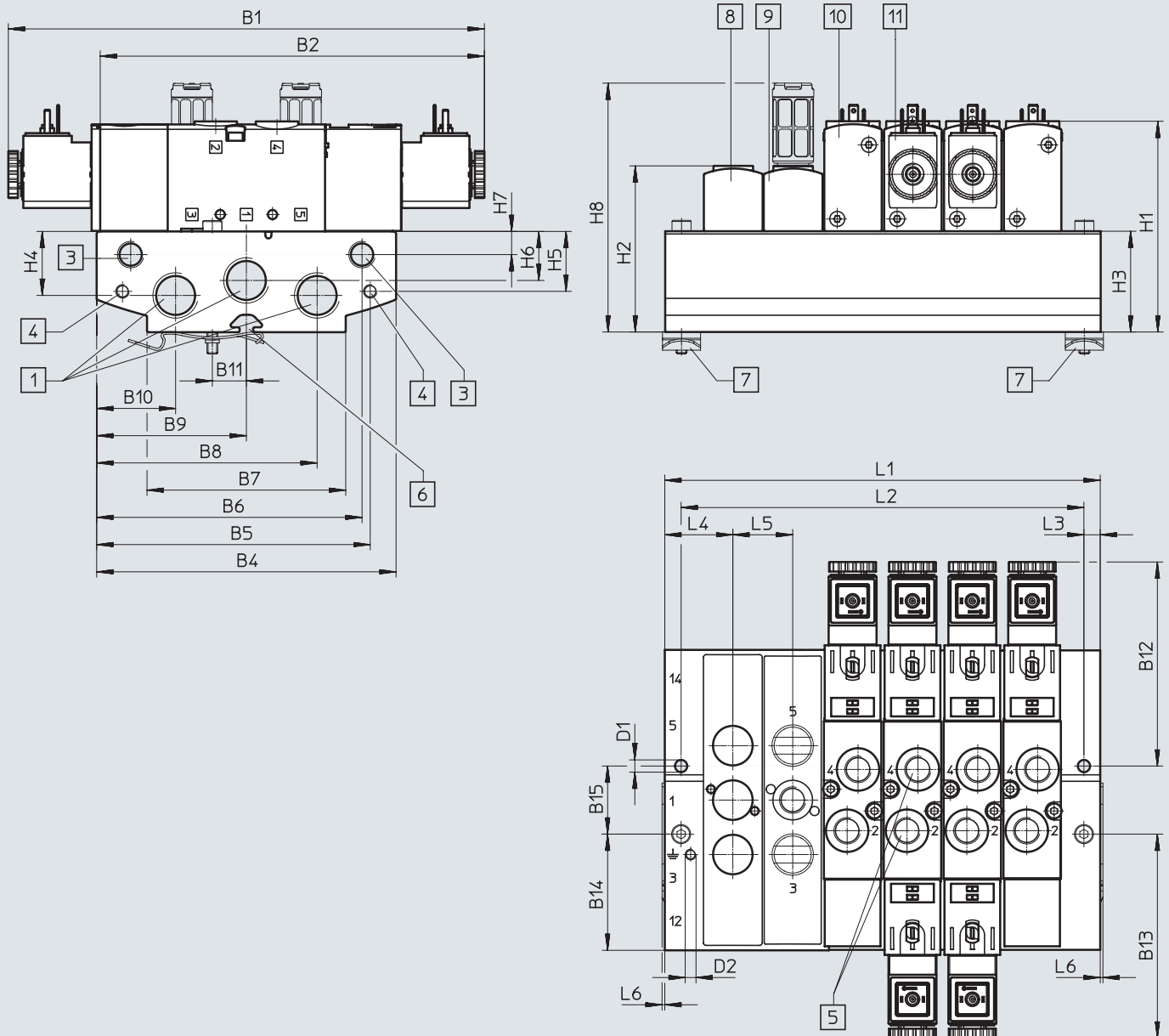

- |  |  |  |   |
|--|--|--|---|
| <p>[1] Port 1, 3 and 5<br/>(on both sides):<br/>3/8 NPT for VTUS-20<br/>1/2 NPT for VTUS-25<br/>3/4 NPT for VTUS-30</p> <p>[3] Port 12 and 14<br/>(on both sides):<br/>1/8 NPT for VTUS-20<br/>1/8 NPT for VTUS-25<br/>1/8 NPT for VTUS-30</p> | <p>[4] Thread for extension module:<br/>M5x15.5 for VTUS-20<br/>M5x18 for VTUS-25<br/>M5x18 for VTUS-30</p> <p>[5] Port 2 and 4:<br/>1/8 NPT for VTUS-20<br/>1/4 NPT for VTUS-25<br/>3/8 NPT for VTUS-30</p> <p>[6] Profile slot IPM-08 system 8</p> | <p>[7] DIN rail mounting VAME-T-M4 for VTUS-20<br/>VAME-T-M5 for VTUS-25<br/>VAME-T-M6 for VTUS-30</p> <p>[8] Cover plate</p> <p>[9] Supply plate.<br/>Port 1, 3 and 5:<br/>G1/8 for VTUS-20<br/>G1/4 for VTUS-25<br/>G3/8 for VTUS-30</p> | <p>[10] 5/2-way valve, single solenoid</p> <p>[11] 5/2-way double solenoid valve<br/>or 5/3-way valve or 2x 3/2-way valve</p> |
|--|--|--|---|

Datasheet – Valve manifold assembly

Type	B1	B2	B4	B5	B6	B7	B8	B9	B10	B11	B12	B13	B14	B15
VTUS-20	174.9	141.2	110	100.5	97.5	73	81	55	29	12.5	75	75	42.5	25
VTUS-25	200.3	162.2	126	119	113.5	80	95	63	31	16	84.2	84.2	47	32
VTUS-30	220.3	180.7	144	137	129	104	111.5	72	32.5	19	91.2	91.2	38	25

Type	D1 ø	D2	H1	H2	H3	H4	H5	H6	H7	H8	L3	L4	L5	L6
VTUS-20	4.5	M4x6.5	77.4	61	37	23.5	22	18	8.5	91.4	6	25	22	1
VTUS-25	5.5	M4x9	95.5	71	45	25	22	22	9	123.4	6	29.8	27.5	1
VTUS-30	6.3	M5x11	118	91	61	35	22	28.5	9	170.1	7.5	34	32	–

Type	Valve positions	2	3	4	5	6	7	8	9	10
VTUS-20	L1 [mm]	72	94	116	138	160	182	204	226	248
	L2 [mm]	60	82	104	126	148	170	192	214	236
VTUS-25	L1 [mm]	87	114.5	142	169.5	197	224.5	252	279.5	307
	L2 [mm]	75	102.5	130	157.5	185	212.5	240	267.5	295
VTUS-30	L1 [mm]	100	132	164	196	228	260	292	324	356
	L2 [mm]	85	117	149	181	213	245	277	309	341

## Datasheet – Valve manifold assembly

### Dimensions – Valve manifold assembly

Download CAD data → [www.festo.com](http://www.festo.com)

With 5/2-, 5/3-, and 2x 3/2-way valve, compact manifold block

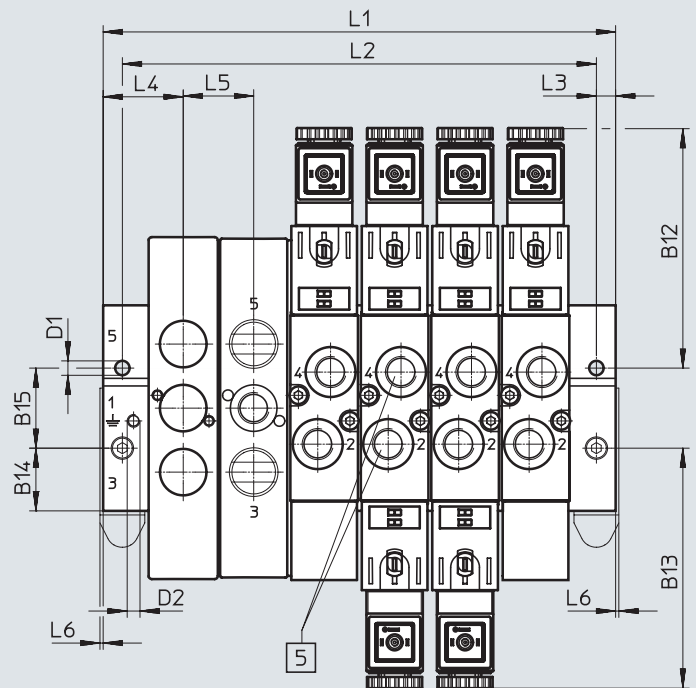
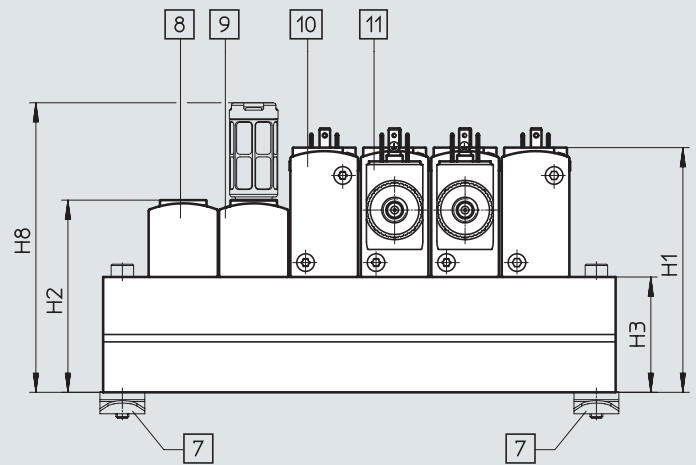
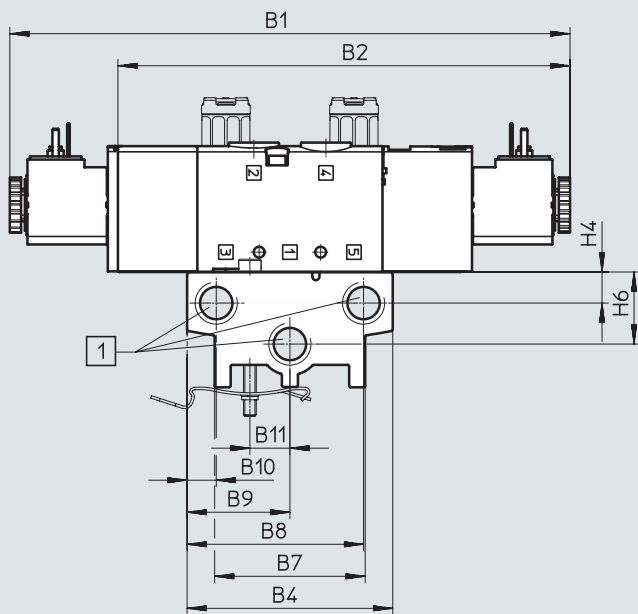

- [1] Port 1, 3 and 5:  
1/4 NPT for VTUS-20  
3/8 NPT for VTUS-25  
1/2 NPT for VTUS-30
- [5] Port 2 and 4:  
1/8 NPT for VTUS-20  
1/4 NPT for VTUS-25  
3/8 NPT for VTUS-30

- [7] DIN rail mounting VAME-T-M4 for VTUS-20  
VAME-T-M5 for VTUS-25  
VAME-T-M6 for VTUS-30
- [8] Cover plate

- [9] Supply plate,  
Port 1, 3 and 5:  
G1/8 for VTUS-20  
G1/4 for VTUS-25  
G3/8 for VTUS-30

- [10] 5/2-way valve, single solenoid
- [11] 5/2-way double solenoid valve  
or 5/3-way valve or 2x 3/2-way valve

Datasheet – Valve manifold assembly

Type	B1	B2	B4	B7	B8	B9	B10	B11	B12	B13	B14	B15
VTUS-20	174.9	141.2	64.2	47	55.1	32.1	9.1	12.5	75	75	19.6	25
VTUS-25	200.3	162.2	80.5	61.5	69	40.3	11.5	16	84.2	84.2	24.3	32
VTUS-30	220.3	180.7	94	77	80.4	47	13.6	19	91.2	91.2	28	38

Type	D1 ø	D2	H1	H2	H3	H4	H6	H8	L3	L4	L5	L6
VTUS-20	4.5	M4x6.5	76.4	60	36	9.7	22.5	90.4	6	25	22	1
VTUS-25	5.5	M4x9	84.5	60	34	13.5	20	112.4	6	29.8	27.5	1
VTUS-30	6.3	M5x11	99.5	72.5	42.5	17.5	26	151.6	7.5	34	32	–

Type	Valve positions	2	3	4	5	6	7	8	9	10
VTUS-20	L1 [mm]	72	94	116	138	160	182	204	226	248
	L2 [mm]	60	82	104	126	148	170	192	214	236
VTUS-25	L1 [mm]	87	114.5	142	169.5	197	224.5	252	279.5	307
	L2 [mm]	75	102.5	130	157.5	185	212.5	240	267.5	295
VTUS-30	L1 [mm]	100	132	164	196	228	260	292	324	356
	L2 [mm]	85	117	149	181	213	245	277	309	341



Datasheet – Valve manifold assembly

Dimensions – Common supply manifold

Download CAD data → [www.festo.com](http://www.festo.com)

Mounting on both sides

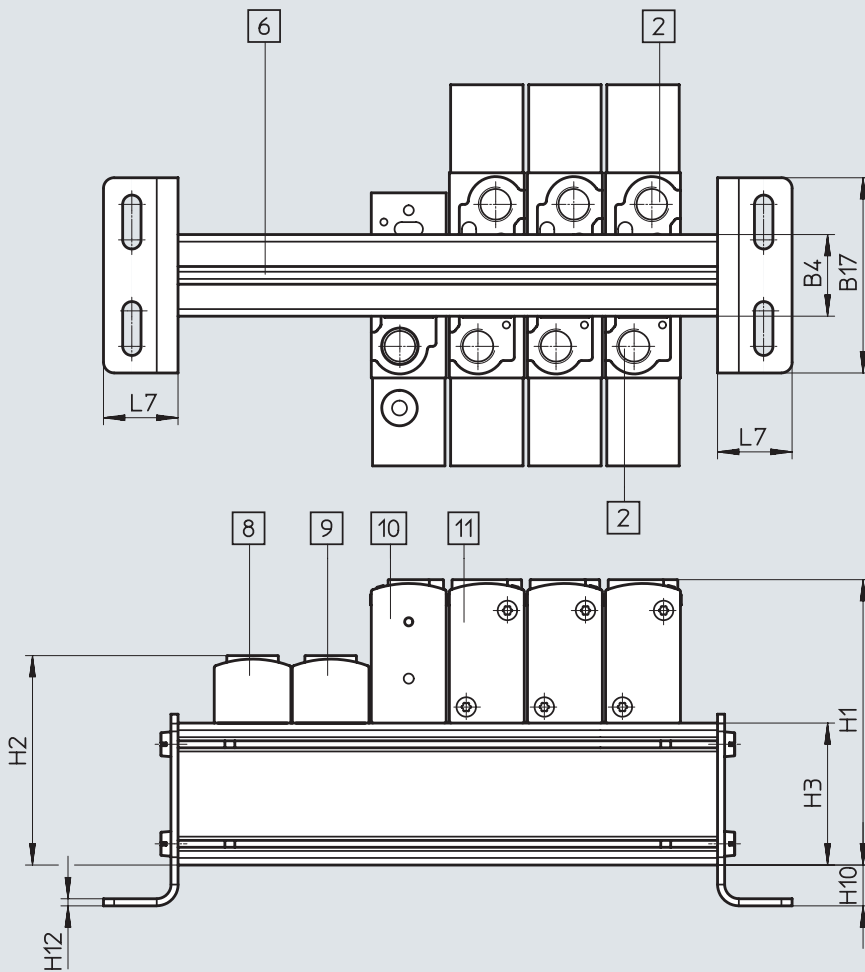

- [2] Port 3 and 5:  
1/8 NPT for VTUS-20  
1/4 NPT for VTUS-25  
3/4 NPT for VTUS-30
- [3] Port 12/14:  
10-32 UNF-2B for VTUS-20  
10-32 UNF-2B for VTUS-25  
1/8 NPT for VTUS-30
- [6] Profile slot IPM-08 system 8
- [8] Cover plate
- [9] Air supply plate,  
port 1:  
G1/8 for VTUS-20  
G1/4 for VTUS-25  
G3/8 for VTUS-30
- [10] 3/2-way valve
- [11] 5/2-way valve, single solenoid
- [12] 5/2-way double solenoid valve  
or 5/3-way valve or 2x 3/2-way  
valve

Type	B4	B17	H1	H2	H3	H10	H11	H12	L7
VTUS-20	23	55	80.4	59	40	11.5	6.3	2	21
VTUS-25	28.7	75	102.5	78	52	18	6.7	2	24
VTUS-30	34	85	122	95	65	17.5	6.7	2.5	26

Datasheet – Valve manifold assembly

Dimensions – Common supply manifold

Download CAD data → [www.festo.com](http://www.festo.com)

Mounting on both sides

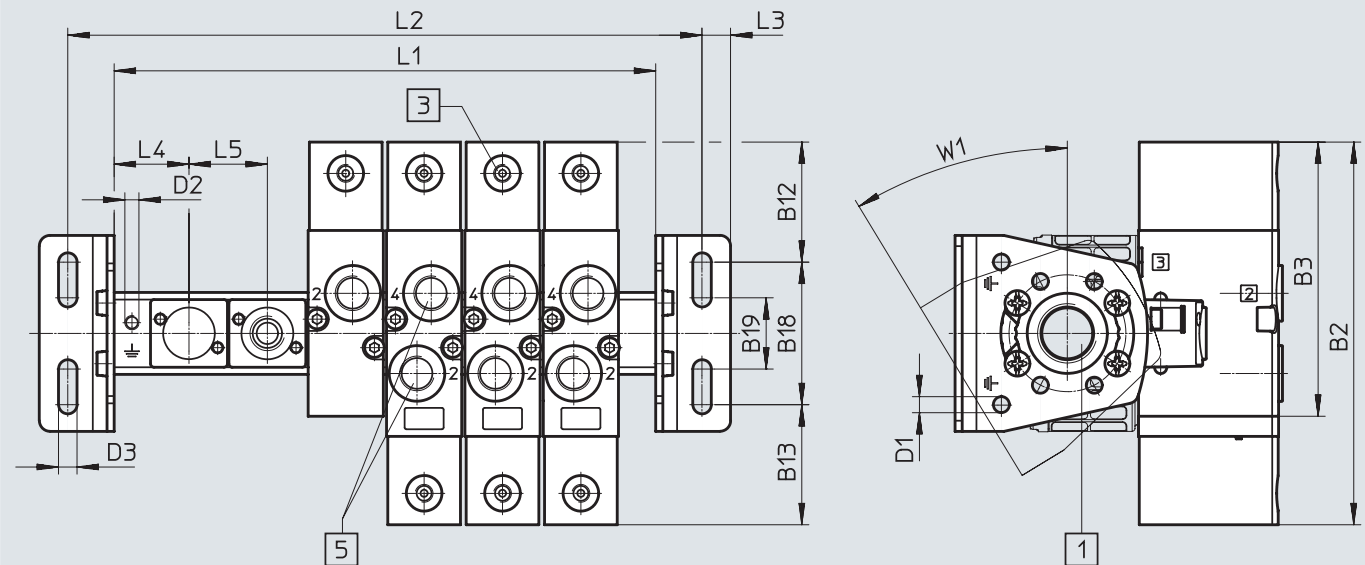

[1] Port 1 (on both sides):  
 3/8 NPT for VTUS-20  
 1/2 NPT for VTUS-25  
 3/4 NPT for VTUS-30

[5] Port 2 and 4:  
 1/8 NPT for VTUS-20  
 1/4 NPT for VTUS-25  
 3/8 NPT for VTUS-30

**Note**  
 Mounting bracket can be adjusted by ±30°.

Type	B1	B2	B3	B12	B13	B18	B19
VTUS-20	174.9	141.2	110.7	67.5	67.5	40	20
VTUS-25	200.3	162.2	129.2	70.2	70.2	60	35
VTUS-30	220.3	180.7	144.9	77.7	77.7	65	35

Type	D1 ø	D2	D3 ø	L3	L4	L5	W1
VTUS-20	4.5	M4x6.5	5.2	8	21	22	30°
VTUS-25	4.5	M4x9	6.6	8	29.8	27.5	30°
VTUS-30	5.5	M5x11	8.6	9	34	32	30°



Type	Valve positions	2	3	4	5	6	7	8	9	10
VTUS-20	L1 [mm]	64	86	108	130	152	174	196	218	240
	L2 [mm]	90	112	134	156	178	200	222	244	266
VTUS-25	L1 [mm]	87	114.5	142	169.5	197	224.5	252	279.5	307
	L2 [mm]	119	146.5	174	201.5	229	256.5	284	311.5	339
VTUS-30	L1 [mm]	100	132	164	196	228	260	292	324	356
	L2 [mm]	134	166	198	230	262	294	326	358	390

## Type codes – Solenoid valves

001	Series
VUVS	Solenoid valve, universal
002	Directional control valve type
L	In-line valve
003	Design principle
	Piston spool
K	Piston spool with sealing ring
T	Poppet valve
004	Size
20	Size 20
25	Size 25
30	Size 30
005	Valve function
M32U	3/2-way valve, normally open
T32U	2x3/2-way valve, normally open
T32C	2x3/2-way valve, normally closed
T32H	2x3/2-way valve, 1x normally closed, 1x normally open
B52	5/2-way valve, double solenoid/bistable
M52	5/2-way valve, single solenoid/monostable
M32C	3/2-way valve, normally closed
P53U	5/3-way valve, mid-position pressurised
P53E	5/3-way valve, mid-position exhausted
P53C	5/3-way valve, mid-position closed
006	Reset method for monostable/single solenoid valves
	None
A	Pneumatic spring
M	Mechanical spring
007	Pilot air
	Internal
Z	External
008	Manual override
D	Non-detenting, detenting
H	Non-detenting
S	Covered
009	Pneumatic connection
G18	G1/8
G14	G1/4
G38	G3/8
N18	1/8 NPT
N14	1/4 NPT
N38	3/8 NPT
Q4	Push-in connector 4 mm
Q6	Push-in connector 6 mm
Q8	Push-in connector 8 mm
Q10	Push-in connector 10 mm
Q12	Push-in connector 12 mm
T38	Push-in connector 3/8"
T14	Push-in connector 1/4"
T12	Push-in connector 1/2"
T532	Push-in connector 5/32"
T516	Push-in connector 5/16"

010	Exhaust
	No fitting
QN	With fitting
U1	Silencer with metallic housing
U3	Silencer with polymer housing
U5	Sintered silencer, long
011	Valve pilot control interface
	Standard
F8	With armature tube 8 mm, long
F7	With armature tube 8 mm, short
FN	With armature tube 9 mm
012	Nominal operating voltage
	None
1	24 V DC
1A	24 V AC/50-60 Hz
3A	230 V AC/50-60 Hz
3W	230 V AC/240 V AC/50-60 Hz
5	12 V DC
16B	120 V AC/60 Hz and 110V AC/50-60 Hz
013	Electrical connection
	None
A1	Plug pattern type A, to EN 175301-803
B2	Connection pattern type B, industry standard
C1	Plug pattern type C, to EN 175301-803
K1	Cable
014	Degree of protection, electrical system
	Standard
S1	IP65
S8	IP67
015	EU certification
	None
EX2	II 3GD
EX4	II 2GD
016	Electrical valve accessories
	None
G	Connector socket, without LED
GL	Connector socket, with LED
GS	Connector socket, with protective circuit
017	Version
	Expanded properties
S	Focused properties

## Datasheet

-  - Flow rate  
up to 600 l/min
-  - Valve width  
21 mm
-  - Voltage  
24 V DC

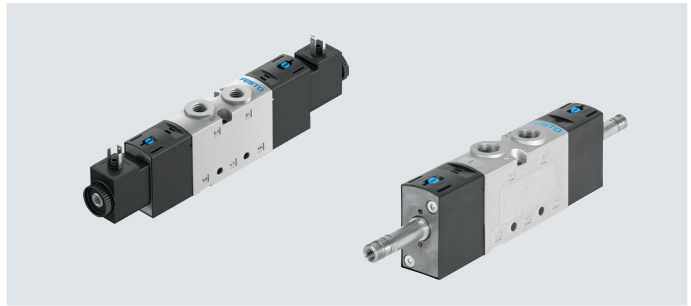

General technical data								
Valve function	3/2-way valve						5/2-way valve	
Order code for valves	M32C	M32U	T32C	T32U	T32H	M52	B52	
Valve width [mm]	21							
Nominal width [mm]	5.2	5.2	5.2	5.2	5.2	5	5	
Design	Poppet seat							
Flow direction	Not reversible							
Pilot air supply	Internal							
Type of control	Piloted							
Manual override	Non-detenting, detenting							
Sealing principle	Soft							
Overlap	Negative overlap							
Type of mounting	Optionally via through-hole or on manifold rail							
Standard nominal flow rate qnN [l/min]	600						500	
Actuation type	Electrical							
Mounting position	Any							
Exhaust air function	Can be throttled							
Connection for venting hole	Not ducted							
b value	0.39	0.29	0.39	0.29	0.34	0.31	0.27	
c value	2.3	2.3	2.3	2.3	2.3	2.1	2.1	
Pneumatic port	1, 2, 3	1/8 NPT	1/8 NPT	1/8 NPT	1/8 NPT	1/8 NPT	1/8 NPT	1/8 NPT
	4, 5	-	-	1/8 NPT	1/8 NPT	1/8 NPT	1/8 NPT	1/8 NPT
Pilot exhaust air port 82, 84	10-32 UNF-2B							
Corrosion resistance <sup>1)</sup>	2							

1) More information [www.festo.com/x/topic/crc](http://www.festo.com/x/topic/crc)

ATEX	
Type	VUVS-LT-...-EX2
ATEX category for gas	II 3G
Type of (ignition) protection for gas	Ex ec IICT4 Gc X
ATEX category for dust	II 3D
Type of ignition protection for dust	Ex tc IIIC T115°C Dc X
Explosion-proof ambient temperature [°C]	10 °C ≤ Ta ≤ +60 °C
CE marking (see declaration of conformity) <sup>1)</sup>	To EU Explosion Protection Directive (ATEX)
UKCA marking (see declaration of conformity) <sup>1)</sup>	To UK explosion regulations
Explosion protection certification outside the EU	EPL Dc (GB)
	EPL Gc (GB)

1) For information about the area of use, see the declaration of conformity at: [www.festo.com/catalogue/...](http://www.festo.com/catalogue/...) → Support/Downloads.  
If the devices are subject to usage restrictions in residential, commercial or light-industrial environments, further measures for the reduction of the emitted interference may be necessary.

## Datasheet

Technical data		M32C	M32U	T32C	T32U	T32H	M52	B52
Order code for valves		M32C	M32U	T32C	T32U	T32H	M52	B52
Normal position		Closed	Open	2x normally closed	2x normally open	1x open/ 1x closed	–	–
Stable position		Monostable	Monostable	Monostable	Monostable	Monostable	Monostable	Bistable
Reset method		Mechanical spring		Mechanical spring			Mechanical spring	–
Switching times in [ms]	On	9	10	9	9	9	15	–
	Off	23	24	25	23	23	19	–
	Change-over	–	–	–	–	–	–	8
Product weight (without solenoid coil)	[g]	112	112	180	180	180	167	181

Safety characteristics		
Max. positive test pulse with logic 0	[µs]	1900 (valves with VACS)
Max. negative test pulse with logic 1	[µs]	2700 (valves with VACS)
Shock resistance		Shock test with severity level 2 to FN 942017-5 and EN 60068-2-27
Vibration resistant		Transport application test with severity level 2 to FN 942017-4 and EN 60068-2-6

Operating and environmental conditions		M32C	M32U	T32C	T32U	T32H	M52	B52	
Order code for valves		M32C	M32U	T32C	T32U	T32H	M52	B52	
Operating medium		Compressed air to ISO 8573-1:2010 [7:4:4]							
Pilot medium		Compressed air to ISO 8573-1:2010 [7:4:4]							
Note on the operating/pilot medium		Lubricated operation possible (in which case lubricated operation will always be required)							
Cleanroom class		ISO class 6							
Operating pressure	[MPa]	0.25 ... 1				0.3 ... 1		0.15 ... 1	
	[bar]	2.5 ... 10				3 ... 10		1.5 ... 10	
Ambient temperature	[°C]	–5 ... +60				–10 ... +60			
Temperature of medium	[°C]	–10 ... +60				–10 ... +60			
Certification		c UL us - Recognized (OL)							
Corrosion resistance class CRC <sup>1)</sup>		2							

1) More information [www.festo.com/x/topic/crc](http://www.festo.com/x/topic/crc)

Electrical data		
Electrical connection		Via solenoid coil
Operating voltage	[V DC]	→ Internet: vacs
Permitted voltage fluctuations	[%]	
Power	[W]	
Duty cycle	[%]	
Degree of protection to EN 60529		

Materials		
Housing		Die-cast aluminium (painted)
Seals		HNBR, NBR, TPE-U(PU)
Screws		Galvanised steel
Note on materials		RoHS-compliant

Datasheet

Dimensions

Download CAD data → [www.festo.com](http://www.festo.com)

3/2-way valves, with solenoid coil

3/2-way valves, without solenoid coil

VUVS-LT20-M32 . . . -M3D- . . .

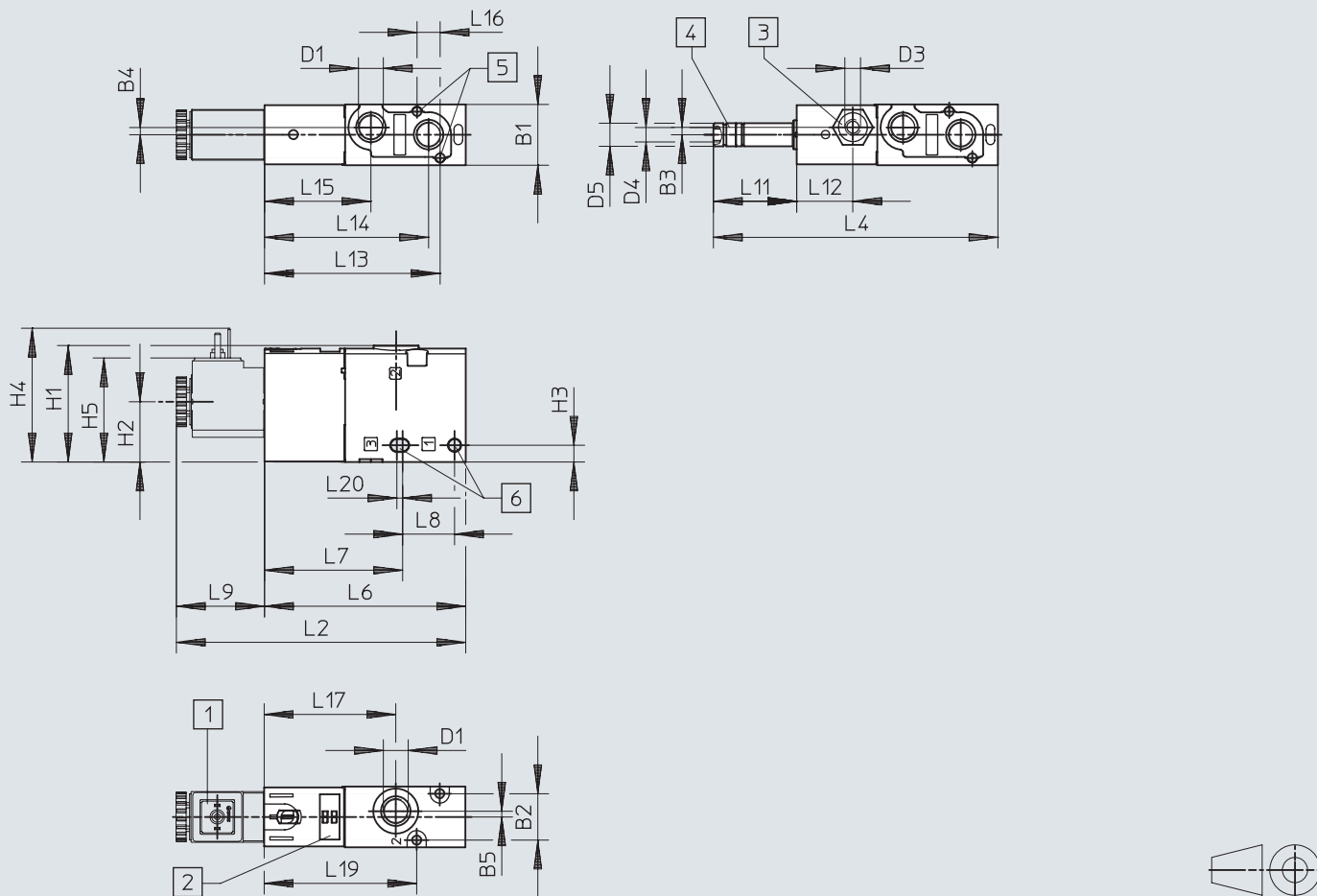

- [1] Solenoid coil interface type C
- [2] Space for inscription label
- [4] Port 10/12 for pilot air supply
- [6] Port 82 for pilot exhaust air
- [7] For screw M3

Type	B1	B2	B3	B4	B5	D1	D3	D4	D5 ∅	H1	H2	H3	H4	H5
VUVS-LT20-M32...MD-N18-...	21.1	16.1	-	2.5	2	1/8 NPT	-	10-32 UNF-2B	8	40.4	20.9	6.2	46.7	36.4

Type	L2	L4	L6	L7	L8	L9	L11	L12	L13	L14	L15	L16	L17	L19
VUVS-LT20-M32...MD-N18-...	100.4	98.8	69.8	47.3	19.2	30.6	29	-	60.9	56.9	36.9	8	45.6	52.9

Datasheet

Dimensions

Download CAD data → [www.festo.com](http://www.festo.com)

5/2-way single solenoid valves, with solenoid coil

5/2-way single solenoid valves, without solenoid coil

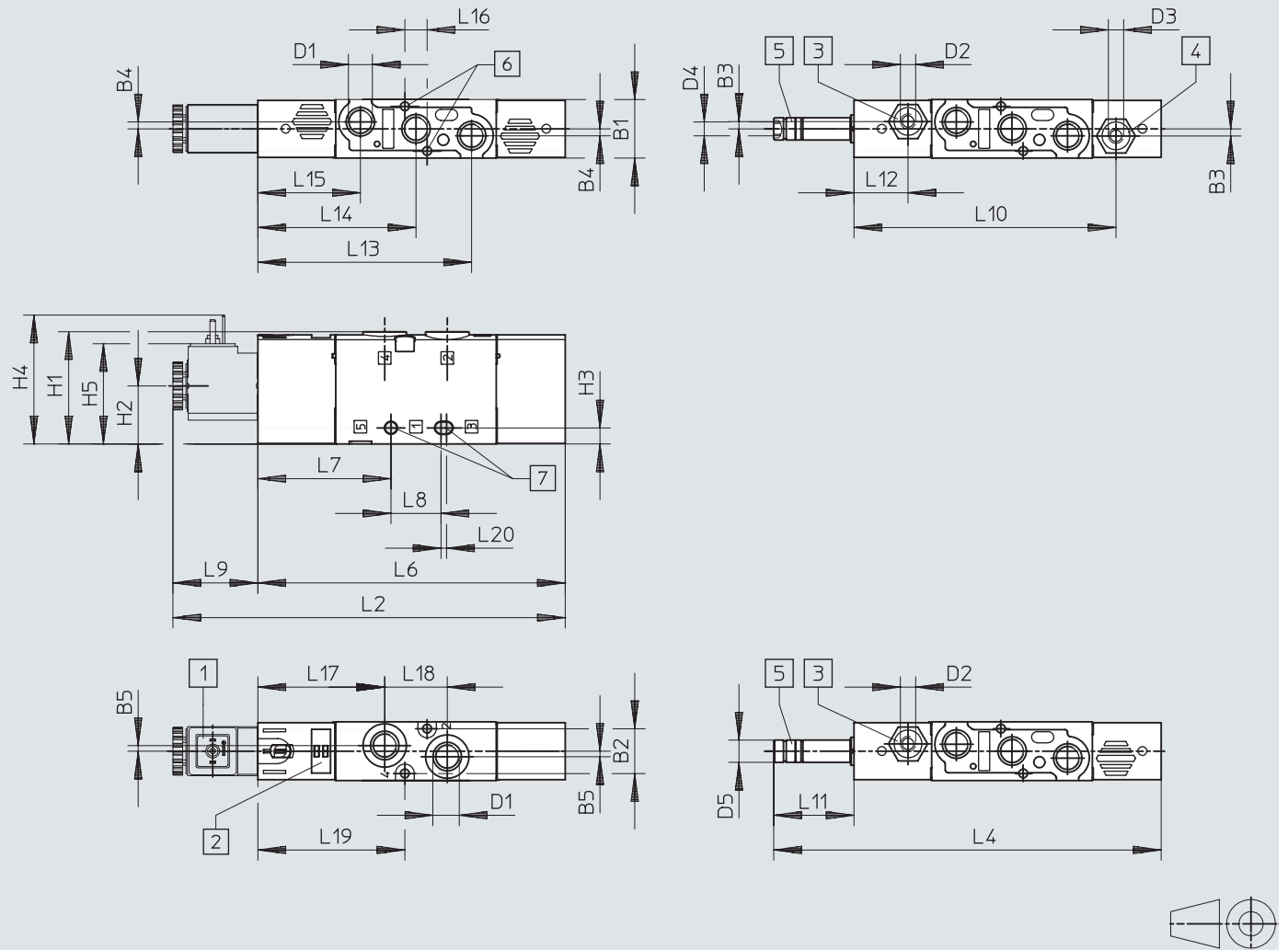

- [1] Solenoid coil for interface type C
- [2] Space for inscription label
- [3] Port 14 for pilot air supply
- [4] Port 12 for pilot air supply (pneumatic spring)
- [5] Port 84 for pilot exhaust air
- [6] For screw M3
- [7] For screw M4

Type	B1	B2	B3	B4	B5	D1	D2	D3	D4	D5 ∅	H1	H2	H3	H4	H5
VUVS-LT20-M52-...MD-N18-...	21.1	16.1	-	2.5	2	1/8 NPT	-	-	10-32 UNF-2B	8	40.4	20.9	5.8	46.7	36.4

Type	L2	L4	L6	L7	L8	L9	L10	L11	L12	L13	L14	L15	L16	L17	L18	L19	L20
VUVS-LT20-M52-...MD-N18-...	141.2	139.6	110.6	47.9	18	30.6	-	29	-	76.9	56.9	36.9	8	45.6	22.5	52.9	2

Datasheet

Dimensions

Download CAD data → [www.festo.com](http://www.festo.com)

2x 3/2-way valves and 5/2-way double solenoid valves, with solenoid coil

2x 3/2-way valves and 5/2-way double solenoid valves, without solenoid coil

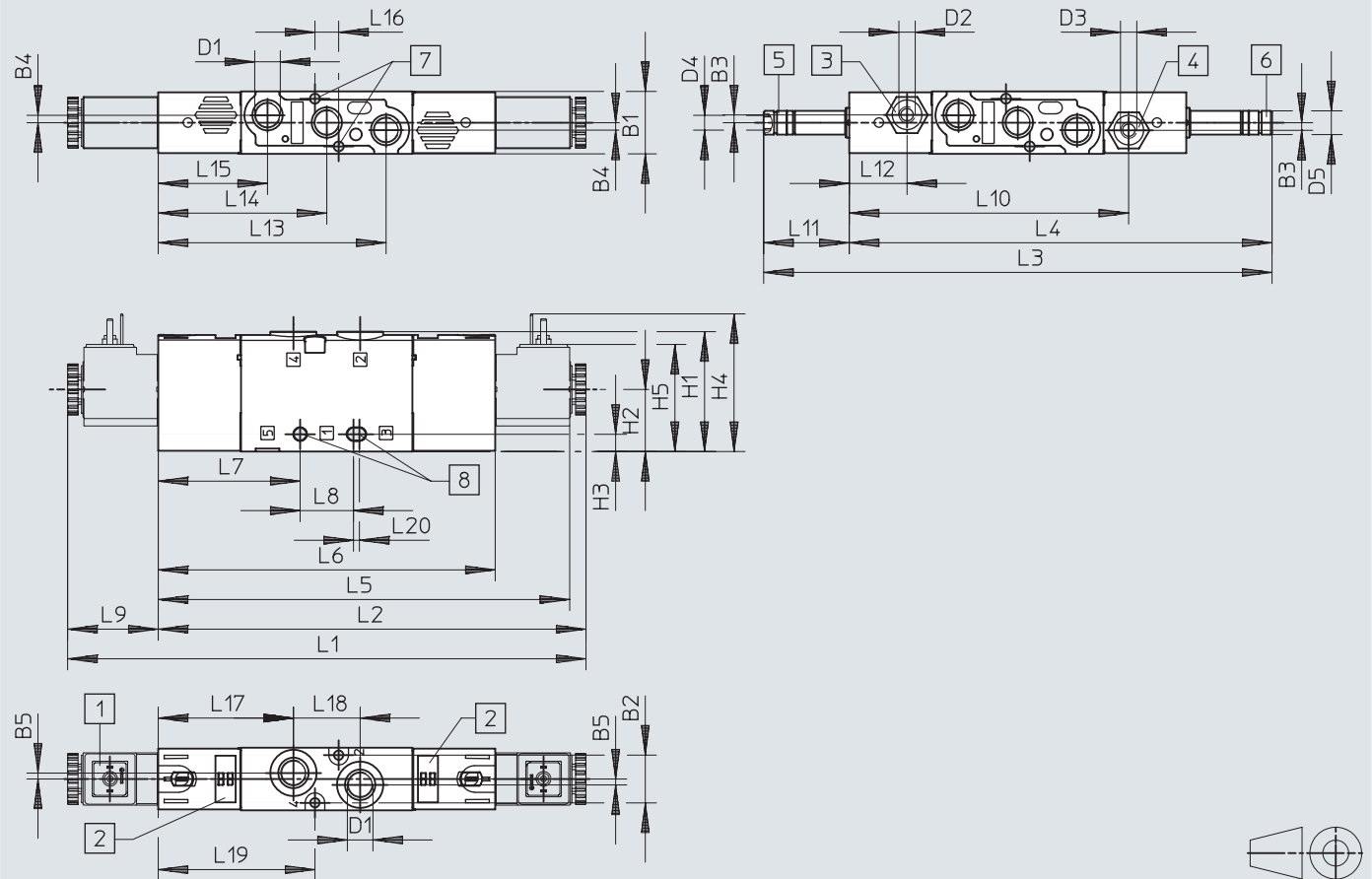

- [1] Solenoid coil interface type C
- [2] Space for inscription label
- [3] Port 14 for pilot air supply
- [4] Port 12 for pilot air supply
- [5] Port 84 for pilot exhaust air
- [6] Port 82 for pilot exhaust air
- [7] For screw M3
- [8] For screw M4

Type	B1	B2	B3	B4	B5	D1	D2	D3	D4	D5	H1
VUVS-LT20-B52-D-N18-...	21.1	16.1	-	2.5	2	1/8 NPT	-	-	10-32 UNF-2B	8	40.4
VUVS-LT20-T32...-MD-N18-...											

Type	H2	H3	H4	H5	L1	L2	L3	L4	L5	L6	L7	L8
VUVS-LT20-B52-D-N18-...	20.9	5.8	46.7	36.4	174.9	144.3	171.7	142.7	139.1	113.7	47.9	18
VUVS-LT20-T32...-MD-N18-...												

Type	L9	L10	L11	L12	L13	L14	L15	L16	L17	L18	L19	L20
VUVS-LT20-B52-D-N18-...	30.6	-	29	-	76.9	56.9	36.9	8	45.6	22.5	52.9	2
VUVS-LT20-T32...-MD-N18-...												



Accessories

Dimensions

Download CAD data → [www.festo.com](http://www.festo.com)

Foot mounting

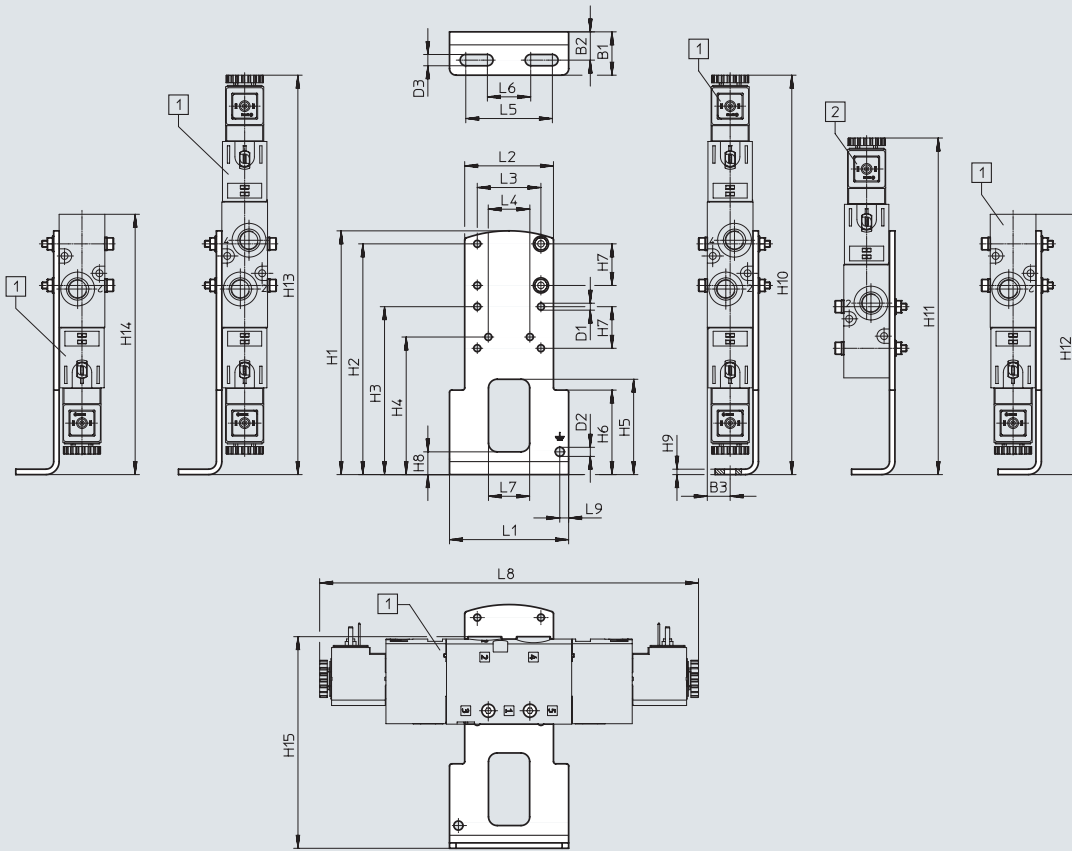

[1] VUVS-LT20-B52/T32  
 VUVS-LT20-M52  
 VUVS-LT20-M32

[2] VUVS-LT20-M52  
 VUVS-LT20-M32

Type		B1	B2	B3	D1 ∅	D2 ∅	D3	H1	H2	H3	H4
VAME-B10-20-A	VUVS-LT20-B52/T32	20	13.1	10.6	3.2	4.2	5.2	112.5	106.5	77.5	63.5
	VUVS-LT20-M52										
	VUVS-LT20-M32										

Type		H5	H6	H7	H8	H9	H10	H11	H12	H13	H14
VAME-B10-20-A	VUVS-LT20-B52/T32	44	39	19.2	10.5	2.5	184.4	–	184.4	184.4	184.4
	VUVS-LT20-M52							155.4	150.6		150.6
	VUVS-LT20-M32								109.8		109.8

Type		H15	L1	L2	L3	L4	L5	L6	L7	L8	L9
VAME-B10-20-A	VUVS-LT20-B52/T32	97.7	55	41	29.4	19.2	40	20	19	174.9	4.1
	VUVS-LT20-M52									141.2	
	VUVS-LT20-M32									100.4	

Accessories

Dimensions

Download CAD data → [www.festo.com](http://www.festo.com)

Wall mounting

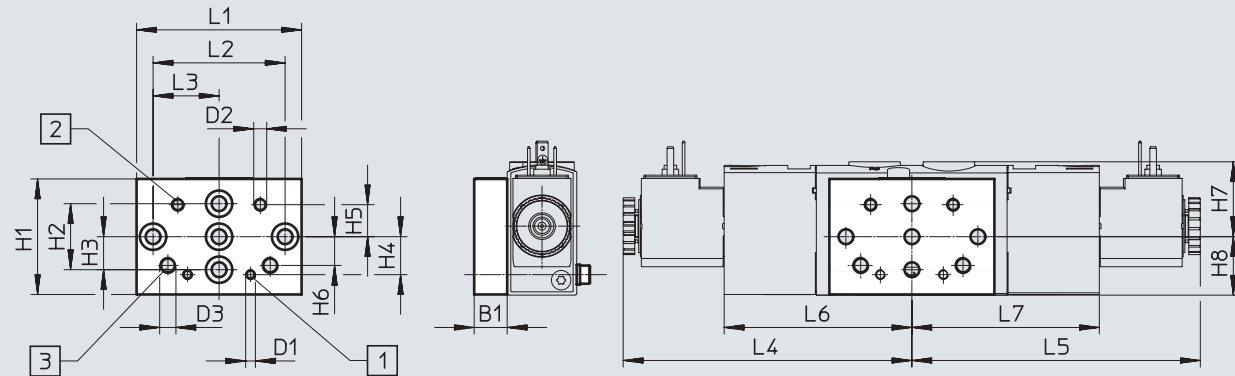

[1] Mounting hole for size 20

[2] Mounting hole for size 25





[3] Mounting hole for size 30

Type		B1	D1	D2	D3	H1	H2	H3	H4	H5	H6
VAME-B10-20-W	VUVS-LT20-B52/T32	10	M3	M4	M5	35	20	10	11.5	9.7	8.7
	VUVS-LT20-M52										
	VUVS-LT20-M32										

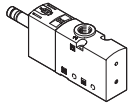
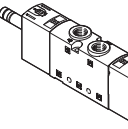
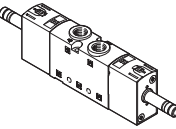
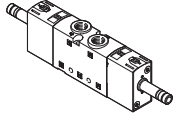

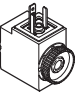

Type		H7	H8	L1	L2	L3	L4	L5	L6	L7
VAME-B10-20-W	VUVS-LT20-B52/T32	22.7	17.7	50	40	20	87.5	87.5	56.9	56.9
	VUVS-LT20-M52							53.7		-
	VUVS-LT20-M32							12.9		-

## Accessories

Ordering data		Code	Valve function	Part no.	Type
<b>3/2-way valve without solenoid coil</b>					
	<b>Single solenoid, normally closed</b>				
	M32C-M	Mechanical spring return, internal pilot air supply, flow direction not reversible	577504	VUVS-LT20-M32C-MD-N18-F7	
	<b>Single solenoid, normally open</b>				
	M32U-M	Mechanical spring return, internal pilot air supply, flow direction not reversible	577505	VUVS-LT20-M32U-MD-N18-F7	
<b>2x 3/2-way valve without solenoid coil</b>					
	<b>Single solenoid, normally closed</b>				
	T32C	Mechanical spring return, internal pilot air supply, flow direction not reversible	577508	VUVS-LT20-T32C-MD-N18-F7	
	<b>Single solenoid, normally open</b>				
	<b>Double solenoid</b>				
	B52	Internal pilot air supply, flow direction not reversible	577507	VUVS-LT20-B52-D-N18-F7	



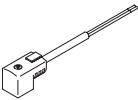

Ordering data		Description	Part no.	Type
<b>Solenoid coils for valves</b>				
	Plug pattern type C, to DIN EN 175301-803	12 V DC	8025331	VACS-C-C1-5
		24 V DC	8025330	VACS-C-C1-1
		48 V DC	8025336	VACS-C-C1-7
		24 V AC/50-60 Hz	8025335	VACS-C-C1-1A
		48 V AC/50-60 Hz	8025337	VACS-C-C1-7A
		110/120 V AC/50-60 Hz	8025334	VACS-C-C1-16B
	Plug pattern type C, industry standard	24 V DC	8153948	VACS-C-E1-1
	M8 individual plug, 3-pin	24 V DC	8135909	VACS-C-R8-1RAL
	Single plug M8, 4-pin	24 V DC	8135910	VACS-C-R1-1RAL
	Single plug M12, A-coded, to EN 61076-2-101	24 V DC	8194567	VACS-C-R3-1RAL
	Single plug M12, A-coded, pin assignment to DESINA	24 V DC	8135911	VACS-C-R4-1RAL
<b>Seal set</b>				
	For solenoid coil to guarantee degree of protection IP67		2643771	VAMC-B10-C-B-S8
<b>Cover cap</b>				
	For manual override, non-detenting or covered		8028240	VAMC-B10-20-CH2

## Accessories

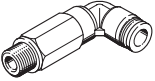
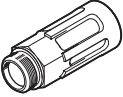

Ordering data		Description	Part no.	Type		
<b>Plug socket</b>						
	<b>Plug pattern type C, to EN 175301-803</b>					
	3-pin, screw terminal	Cable connector M12	0 ... 250 V AC/DC	IP65	<b>539712</b>	<b>MSSD-EB-M12</b>
		Cable connector Pg7			<b>151687</b>	<b>MSSD-EB</b>
3-pin, angled socket	Cable connector M12	0 ... 24 V DC	IP65	<b>570367</b>	<b>MSSD-EB-M12-24VDC-SD-EX</b>	
<b>Adapter</b>						
	Socket type C, to EN 175301-803	Plug M12x1, 2-pin, A-coded	12 ... 24 V AC/DC	IP65	<b>188024</b>	<b>MSSD-EB-M12-MONO</b>
<b>Plug socket with cable</b>						
	<b>Plug pattern type C, to EN 175301-803</b>					
	Angled socket, 3-pin Cable, open end, 3-core	24 V DC	LED	2.5 m	<b>151688</b>	<b>KMEB-1-24-2.5-LED</b>
				5 m	<b>151689</b>	<b>KMEB-1-24-5-LED</b>
				10 m	<b>193457</b>	<b>KMEB-1-24-10-LED</b>
	230 V AC <sup>1)</sup>	–	2.5 m	<b>151690</b>	<b>KMEB-1-230AC-2.5</b>	
5 m			<b>151691</b>	<b>KMEB-1-230AC-5</b>		
<b>Illuminating seal</b>						
	Plug pattern type C, to DIN EN 175301-803		24 V DC	<b>151717</b>	<b>MEB-LD-12-24DC</b>	
			230 V AC	<b>151718</b>	<b>MEB-LD-230AC</b>	

1) Plug socket 230 V AC can be used for 24 V DC without LED configuration.

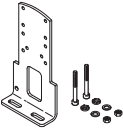
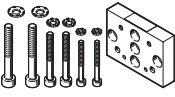
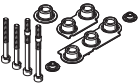

## Accessories

Ordering data		Description	Part no.	Type	PU <sup>1)</sup>
<b>Push-in fitting with internal hex</b>					
	Connecting thread 10-32 UNF for tubing O.D.	5/32 "	572312	QBM-10-32-UNF-5/32-I-U	10
	Connecting thread 1/8 NPT for tubing O.D.	5/32 "	572317	QB-1/8-5/32-I-U	10
		1/4 "	572318	QB-1/8-1/4-I-U	10
		5/16 "	572319	QB-1/8-5/16-I-U	10
<b>Angled push-in fitting, with external hex</b>					
	Connecting thread 1/8 NPT for tubing O.D.	5/32 "	533290	QBL-1/8-5/32-U	10
		1/4 "	533292	QBL-1/8-1/4-U	10
		5/16 "	533293	QBL-1/8-5/16-U	10
<b>Angled push-in fitting, long, with external hex</b>					
	Connecting thread 1/8 NPT for tubing O.D.	5/32 "	564668	QBLL-1/8-5/32-U	10
		1/4 "	564670	QBLL-1/8-1/4-U	10
		5/16 "	564671	QBLL-1/8-5/16-U	10
<b>Silencer</b>					
	With connecting thread NPT, metal design	1/8 NPT	12638	U-1/8-B-NPT	1
	With connecting thread NPT, sintered design, long	1/8 NPT	1206989	AMTE-M-LH-N18	20

1) Packaging unit

Ordering data		Description	Weight [g]	Part no.	Type
<b>Foot mounting</b>					
	With screw set for attaching the valve to the foot mounting	130	576412	VAME-B10-20-A	
<b>Wall mounting</b>					
	With screw set for attaching the valve to the wall mounting	53	576413	VAME-B10-20-W	
<b>Assortment of spare parts</b>					
	Set comprising seals and screws	12	8026203	VAME-B10-20-MK	
<b>Inscription label</b>					
	Frame with 40 labels	-	565306	ASLR-C-E4	

## Datasheet

-  - Flow rate  
up to 1000 l/min ( $\pm 20\%$ )
-  - Valve width  
26.5 mm
-  - Voltage  
24 V DC

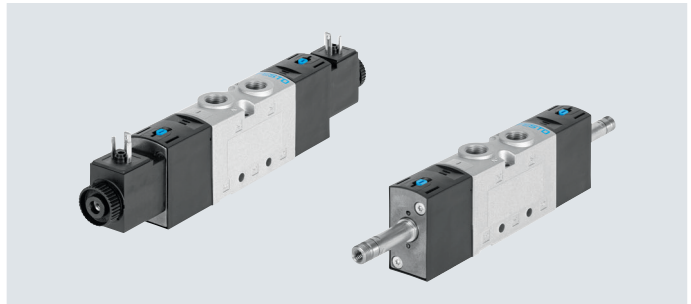

General technical data								
Valve function	3/2-way valve						5/2-way valve	
Order code for valves	M32C	M32U	T32C	T32U	T32H	M52	B52	
Valve width [mm]	26.5							
Nominal width [mm]	6.9	6.6	6.9	6.6	6.9	6.6	6.6	
Design	Poppet seat							
Flow direction	Not reversible							
Pilot air supply	Internal							
Type of control	Piloted							
Manual override	Non-detenting, detenting							
Overlap	Negative overlap							
Sealing principle	Soft							
Type of mounting	Optionally via through-hole or on manifold rail							
Standard nominal flow rate qnN [l/min]	1000							
Actuation type	Electrical							
Mounting position	Any							
Exhaust air function	Can be throttled							
Connection for venting hole	Not ducted							
b value	0.4	0.3	0.4	0.3	0.4	0.3	0.2	
c value [l/sbar]	4.4	4.2	4.5	4.4	4.4	4.5	4.6	
Pneumatic port	1, 2, 3	1/4 NPT	1/4 NPT	1/4 NPT	1/4 NPT	1/4 NPT	1/4 NPT	1/4 NPT
	4, 5	–	–	1/4 NPT	1/4 NPT	1/4 NPT	1/4 NPT	1/4 NPT
Pilot exhaust air port 82, 84	10-32 UNF-2B							

ATEX	
Type	VUVS-LT-...-EX2
ATEX category for gas	II 3G
Type of (ignition) protection for gas	Ex ec IICT4 Gc X
ATEX category for dust	II 3D
Type of ignition protection for dust	Ex tc IIIC T115°C Dc X
Explosion-proof ambient temperature [°C]	10 °C ≤ Ta ≤ +60 °C
CE marking (see declaration of conformity) <sup>1)</sup>	To EU Explosion Protection Directive (ATEX)
UKCA marking (see declaration of conformity) <sup>1)</sup>	To UK explosion regulations
Explosion protection certification outside the EU	EPL Dc (GB)
	EPL Gc (GB)

1) For information about the area of use, see the declaration of conformity at: [www.festo.com/catalogue/...](http://www.festo.com/catalogue/...) → Support/Downloads.  
If the devices are subject to usage restrictions in residential, commercial or light-industrial environments, further measures for the reduction of the emitted interference may be necessary.

## Datasheet

Technical data								
Order code for valves	M32C	M32U	T32C	T32U	T32H	M52	B52	
Normal position	Closed	Open	2x normally closed	2x normally open	1x open/ 1x closed	–	–	
Stable position	Monostable	Monostable	Monostable	Monostable	Monostable	Monostable	Bistable	
Reset method	Mechanical spring		Mechanical spring			Mechanical spring	–	
Switching times in [ms]	On	10	10	10	10	10	13	–
	Off	23	27	25	25	25	22	–
	Change-over	–	–	–	–	–	–	10
Product weight without solenoid coil	[g]	208	208	312	312	312	299	310

Safety characteristics		
Max. positive test pulse with logic 0	[µs]	2000 (valves with VACF)
Max. negative test pulse with logic 1	[µs]	3600 (valves with VACF)
Shock resistance	Shock test with severity level 2 to FN 942017-5 and EN 60068-2-27	
Vibration resistant	Transport application test with severity level 2 to FN 942017-4 and EN 60068-2-6	

Operating and environmental conditions									
Order code for valves	M32C	M32U	T32C	T32U	T32H	M52	B52		
Operating medium	Compressed air to ISO 8573-1:2010 [7:4:4]								
Pilot medium	Compressed air to ISO 8573-1:2010 [7:4:4]								
Note on the operating/pilot medium	Lubricated operation possible (in which case lubricated operation will always be required)								
Cleanroom class	ISO class 6								
Operating pressure	[MPa]	0.25 ... 1				0.25 ... 1		0.15 ... 1	
	[bar]	2.5 ... 10				2.5 ... 10		1.5 ... 10	
Pilot pressure	[MPa]	0.25 ... 1				0.25 ... 1		0.15 ... 1	
	[bar]	2.5 ... 10				2.5 ... 10		1.5 ... 10	
Ambient temperature	[°C]	–5 ... +60				–10 ... +60			
Temperature of medium	[°C]	–5 ... +60				–10 ... +60			
Certification	c UL us - Recognized (OL)								
Corrosion resistance class CRC <sup>1)</sup>	2								

1) More information [www.festo.com/x/topic/crc](http://www.festo.com/x/topic/crc)

Electrical data		
Electrical connection	Via solenoid coil	
Operating voltage	[V DC]	→ Internet: vacf
Permitted voltage fluctuations	[%]	
Power	[W]	
Duty cycle	[%]	
Degree of protection to EN 60529		

Materials	
Housing	Die-cast aluminium (painted)
Seals	HNBR, NBR, TPE-U(PU)
Screws	Galvanised steel
Note on materials	RoHS-compliant

Datasheet

Dimensions

Download CAD data → [www.festo.com](http://www.festo.com)

3/2-way valves, with solenoid coil

3/2-way valves, without solenoid coil

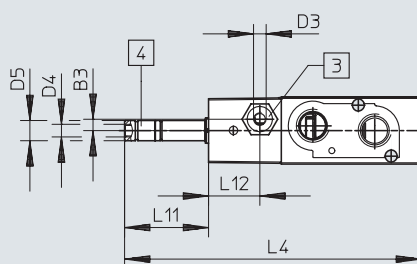
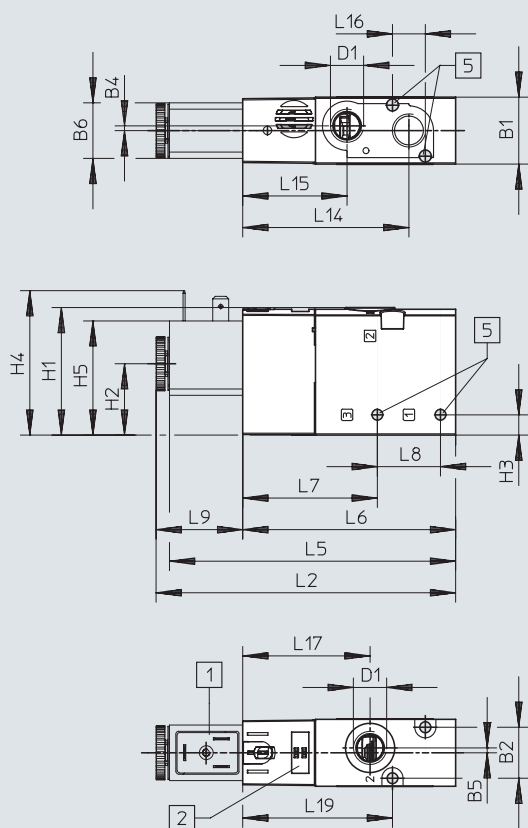

- [1] Solenoid coil interface type B/ type C
- [2] Space for inscription label
- [4] Port 10/12 for pilot air supply
- [6] Port 82 for pilot exhaust air
- [7] For screw M4



Type	B1	B2	B3	B4	B5	B6	D1	D3	D4	D5 ∅	H1	H2	H3	H4	H5
VUVS-LT25-M32...D-N14-...	26.5	20.2	-	1.9	1.9	22	1/4 NPT	-	10-32 UNF-2B	8	50.5	28.2	8	57.2	45.2

Type	L2	L4	L5	L6	L7	L8	L9	L11	L12	L14	L15	L16	L17	L19
VUVS-LT25-M32...D-N14-...	118.7	117.6	113.3	84.3	53.3	25	34.4	33.3	-	65.8	41.3	13	50.4	59.3



Datasheet

Dimensions

Download CAD data → [www.festo.com](http://www.festo.com)

5/2-way single solenoid valves, with solenoid coil

5/2-way single solenoid valves, without solenoid coil

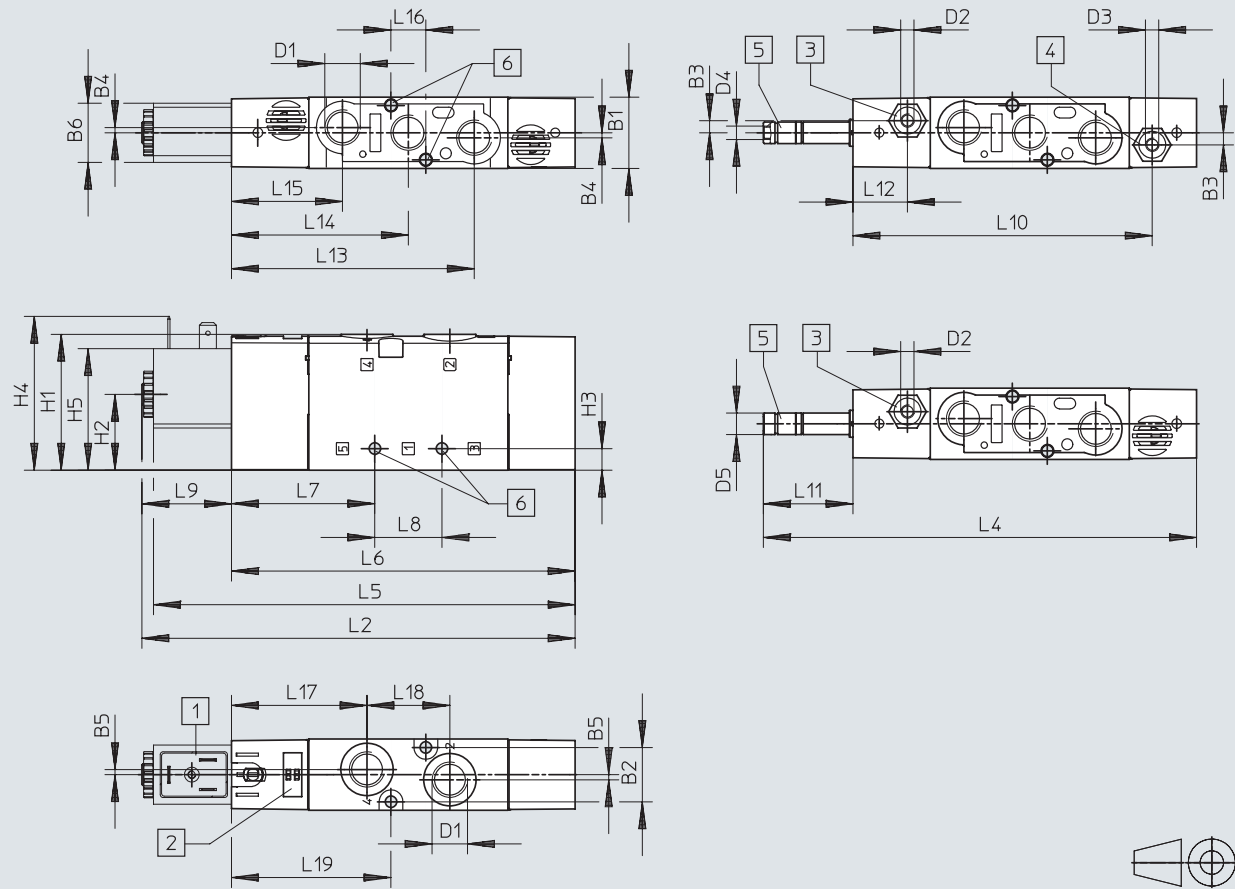

- [1] Solenoid coil
- [2] Space for inscription label
- [3] Port 14 for pilot air supply
- [4] Port 12 for pilot air supply
- [5] Port 84 for pilot exhaust air
- [7] For screw M4

Type	B1	B2	B3	B4	B5	B6	D1	D2	D3	D4	D5	H1	H2	H3	H4	H5
VUVS-LT25-M52...D-N14-...	26.5	20.2	-	1.9	1.9	22	1/4 NPT	-	-	10-32 UNF-2B	8	50.5	28.2	8	57.2	45.2

Type	L2	L4	L5	L6	L7	L8	L9	L10	L11	L12	L13	L14	L15	L16	L17	L18	L19
VUVS-LT25-M52...D-N14-...	162.2	161.1	156.8	127.8	53.3	25	34.4	-	33.3	-	90.3	65.8	41.3	13	50.4	30.8	59.3

Datasheet

Dimensions

Download CAD data → [www.festo.com](http://www.festo.com)

2x 3/2-way valves and 5/2-way double solenoid valves, with solenoid coil

2x 3/2-way valves and 5/2-way double solenoid valves, without solenoid coil

VUVS-L25-P53 . . . . . Z . . . . .  
 VUVS-L25-B52-Z . . . . .

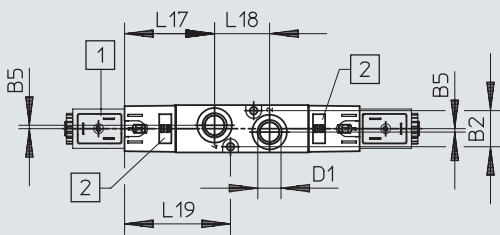
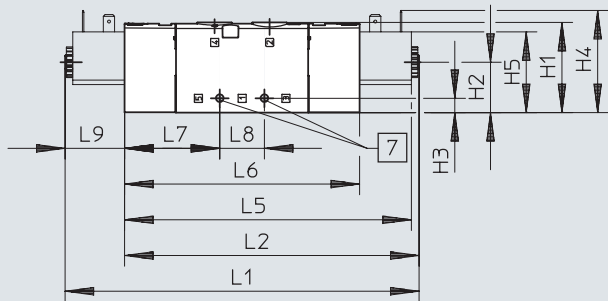
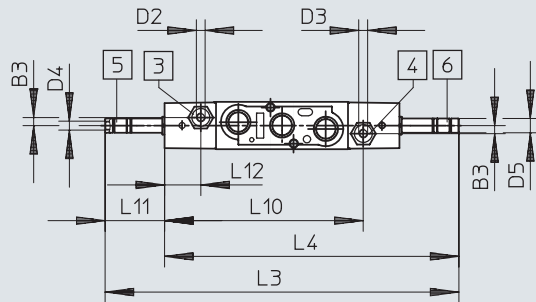
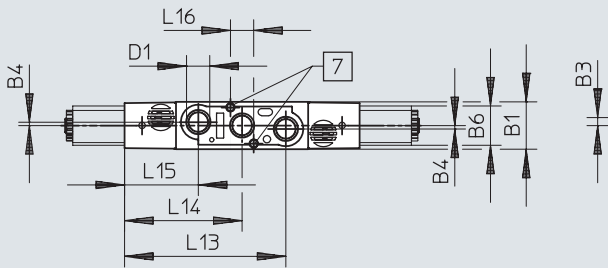

- [1] Solenoid coil interface type B/  
type C
- [2] Space for inscription label
- [3] Port 14 for pilot air supply
- [4] Port 12 for pilot air supply
- [5] Port 84 for pilot exhaust air
- [6] Port 82 for pilot exhaust air
- [7] For screw M4

Type	B1	B2	B3	B4	B5	B6	D1	D2	D3	D4	D5 ∅	H1
VUVS-LT25-B52-D-N14-...	26.5	20.2	-	1.9	1.9	22	1/4 NPT	-	-	10-32 UNF-2B	8	50.5
VUVS-LT25-T32...D-N14-...												

Type	H2	H3	H4	H5	L1	L2	L3	L4	L5	L6	L7	L8
VUVS-LT25-B52-D-N14-...	28.2	8	57.2	45.2	200.3	166	198.2	164.9	160.6	131.6	53.3	25
VUVS-LT25-T32...D-N14-...												

Type	L9	L10	L11	L12	L13	L14	L15	L16	L17	L18	L19
VUVS-LT25-B52-D-N14-...	33.3	-	33.3	-	90.3	65.8	41.3	13	50.4	30.8	59.3
VUVS-LT25-T32...D-N14-...											

Accessories

Dimensions

Download CAD data → [www.festo.com](http://www.festo.com)

Foot mounting

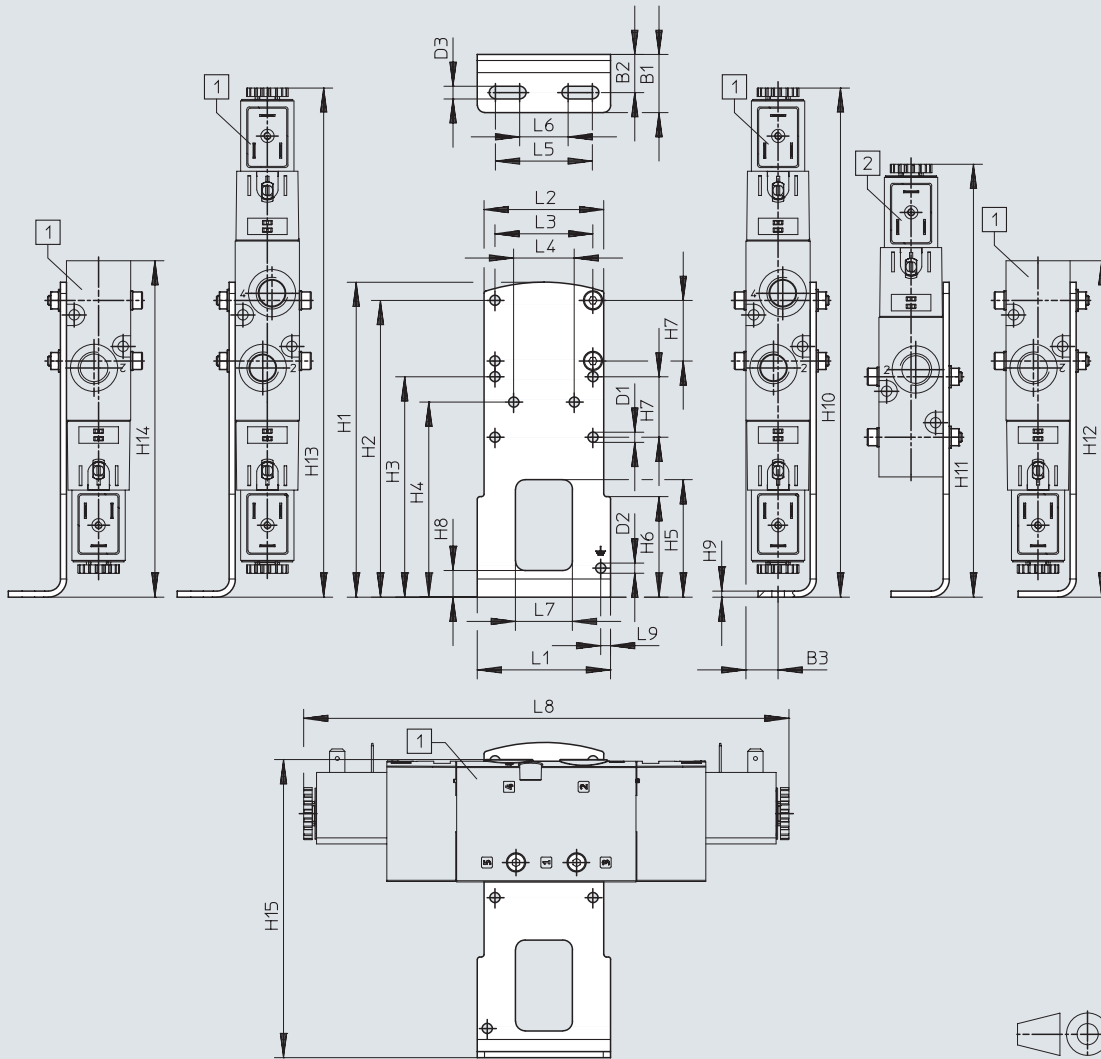

[1] VUVS-LT25-B52  
 VUVS-LT25-T32  
 VUVS-LT25-M52  
 VUVS-LT25-M32

[2] VUVS-LT25-M52,  
 VUVS-LT25-M32

Type		B1	B2	B3	D1 ∅	D2 ∅	D3	H1	H2	H3	H4
VAME-B10-25-A	VUVS-LT25-B52/T32	24	15.8	13.3	4.2	4.2	5.2	130	122.5	91	80.5
	VUVS-LT25-M52										
	VUVS-LT25-M32										

Type		H5	H6	H7	H8	H9	H10	H11	H12	H13	H14
VAME-B10-25-A	VUVS-LT25-B52/T32	48.5	41.5	25	11	2.5	210.2	–	210.2	210.2	210.2
	VUVS-LT25-M52							178.7			172
	VUVS-LT25-M32										138.9

Type		H15	L1	L2	L3	L4	L5	L6	L7	L8	L9
VAME-B10-25-A	VUVS-LT25-B52/T32	123	55	49.4	40.4	25	40	20	23.5	200.3	4.1
	VUVS-LT25-M52									162.2	
	VUVS-LT25-M32									118.7	

Accessories

Dimensions

Download CAD data → [www.festo.com](http://www.festo.com)

Wall mounting

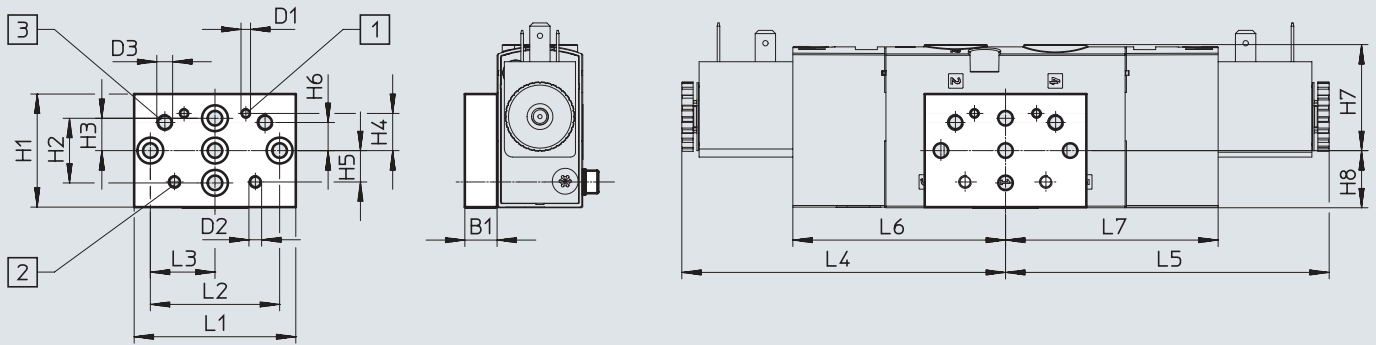

[1] Mounting hole for size 20

[2] Mounting hole for size 25

[3] Mounting hole for size 30





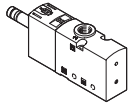
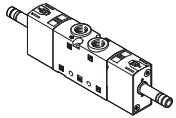
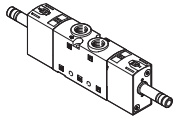
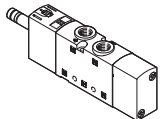
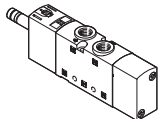
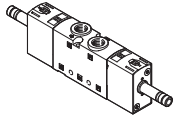

Type		B1	D1	D2	D3	H1	H2	H3	H4	H5	H6
VAME-B10-20-W	VUVS-LT25-B52/T32	10	M3	M4	M5	35	20	10	11.5	9.7	8.7
	VUVS-LT25-M52										
	VUVS-LT25-M32										

Type		H7	H8	L1	L2	L3	L4	L5	L6	L7
VAME-B10-20-W	VUVS-LT25-B52/T32	32.8	17.7	50	40	20	100.2	100.2	65.8	65.8
	VUVS-LT25-M52									
	VUVS-LT25-M32									





## Accessories

Ordering data				
	Code	Valve function	Part no.	Type
<b>3/2-way valve without solenoid coil</b>				
	<b>Single solenoid, normally closed</b>			
	M32C-M	Mechanical spring return, internal pilot air supply, flow direction not reversible	8035216	VUVS-LT25-M32C-MD-N14-F8
	<b>Single solenoid, normally open</b>			
	M32U-M	Mechanical spring return, internal pilot air supply, flow direction not reversible	8035218	VUVS-LT25-M32U-MD-N14-F8
<b>2x 3/2-way valve without solenoid coil</b>				
	<b>Single solenoid, normally closed</b>			
	T32C	Mechanical spring return, internal pilot air supply, flow direction not reversible	8035224	VUVS-LT25-T32C-MD-N14-F8
	<b>Single solenoid, normally open</b>			
T32U	Mechanical spring return, internal pilot air supply, flow direction not reversible	8035226	VUVS-LT25-T32U-MD-N14-F8	
	<b>Single solenoid, 1x normally open, 1x normally closed</b>			
	T32H	Mechanical spring return, internal pilot air supply, flow direction not reversible	8035228	VUVS-LT25-T32H-MD-N14-F8
<b>5/2-way valve without solenoid coil</b>				
	<b>Single solenoid</b>			
	M52	Mechanical spring return, internal pilot air supply, flow direction not reversible	8035220	VUVS-LT25-M52-MD-N14-F8
	<b>Double solenoid</b>			
	B52	Internal pilot air supply, flow direction not reversible	8035222	VUVS-LT25-B52-D-N14-F8

## Accessories



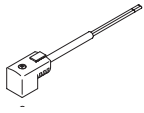

Ordering data		Description	Part no.	Type
<b>Solenoid coils for valves</b>				
	Plug pattern type C, to DIN EN 175301-803	12 V DC	8030810	VACF-B-C1-5
		24 V DC	8030811	VACF-B-C1-1
		48 V DC	8030812	VACF-B-C1-7
		24 V AC/50-60 Hz	8030813	VACF-B-C1-1A
		48 V AC/50-60 Hz	8030814	VACF-B-C1-7A
		110/120 V AC/50-60 Hz	8030815	VACF-B-C1-16B
		230/240 V AC/50-60 Hz	8030817	VACF-B-C1-3W
	Plug pattern type C, industry standard	24 V DC	8153947	VACF-B-E1-1
	Plug pattern type B, industry standard	12 V DC	8030801	VACF-B-B2-5
		24 V DC	8030802	VACF-B-B2-1
		48 V DC	8030803	VACF-B-B2-7
		24 V AC/50-60 Hz	8030804	VACF-B-B2-1A
		48 V AC/50-60 Hz	8030805	VACF-B-B2-7A
		110/120 V AC/50-60 Hz	8030806	VACF-B-B2-16B
		230/240 V AC/50-60 Hz	8030808	VACF-B-B2-3W
	Single plug M8, 3-pin	24 V DC	8135909	VACS-C-R8-1RAL
	Single plug M8, 4-pin	24 V DC	8135910	VACS-C-R1-1RAL
	Single plug M12, A-coded, to EN 61076-2-101	24 V DC	8194567	VACS-C-R3-1RAL
	Single plug M12, A-coded, pin assignment to DESINA	24 V DC	8135911	VACS-C-R4-1RAL
<b>Seal set for solenoid coil</b>				
	Plug pattern type C to guarantee degree of protection IP67		2643771	VAMC-B10-C-B-S8
	Plug pattern type B to guarantee degree of protection IP67		8034609	VAMC-B10-B-B-S8
<b>Cover cap</b>				
	For manual override, non-detenting or covered		8028240	VAMC-B10-20-CH2

## Accessories

Ordering data		Description	Part no.	Type		
<b>Plug socket</b>						
	<b>Plug pattern type C, to EN 175301-803</b>					
	3-pin, screw terminal	Cable connector M12	0 ... 250 V AC/DC	IP65	<b>539712</b>	<b>MSSD-EB-M12</b>
		Cable connector Pg7			<b>151687</b>	<b>MSSD-EB</b>
	3-pin, angled socket	Cable connector M12	0 ... 24 V DC	IP65	<b>570367</b>	<b>MSSD-EB-M12-24VDC-SD-EX</b>
	<b>Plug pattern type B, industry standard</b>					
	3-pin, screw terminal	Cable connector M16	0 ... 250 V AC/DC	IP65	<b>539710</b>	<b>MSSD-F-M16</b>
Cable fitting Pg9		<b>34431</b>			<b>MSSD-F</b>	
<b>Adapter</b>						
	Socket type C, to EN 175301-803	Plug M12x1, 2-pin, A-coded	12 ... 24 V AC/DC	IP65	<b>188024</b>	<b>MSSD-EB-M12-MONO</b>
<b>Plug socket with cable</b>						
	<b>Plug pattern type C, to EN 175301-803</b>					
	Angled socket, 3-pin Cable, open end, 3-core	24 V DC	LED	2.5 m	<b>151688</b>	<b>KMEB-1-24-2.5-LED</b>
				5 m	<b>151689</b>	<b>KMEB-1-24-5-LED</b>
				10 m	<b>193457</b>	<b>KMEB-1-24-10-LED</b>
	230 V AC <sup>1)</sup>	–	2.5 m	<b>151690</b>	<b>KMEB-1-230AC-2.5</b>	
			5 m	<b>151691</b>	<b>KMEB-1-230AC-5</b>	
	<b>Plug pattern type B, industry standard</b>					
	Angled socket, 3-pin Cable, open end, 3-core	24 V DC	LED	2.5 m	<b>30935</b>	<b>KMF-1-24DC-2.5-LED</b>
				5 m	<b>30937</b>	<b>KMF-1-24DC-5-LED</b>
				10 m	<b>193458</b>	<b>KMF-1-24-10-LED</b>
230 V AC <sup>1)</sup>	–	2.5 m	<b>30936</b>	<b>KMF-1-230AC-2.5</b>		
		5 m	<b>30938</b>	<b>KMF-1-230AC-5</b>		
<b>Illuminating seal</b>						
	Plug pattern type C, to DIN EN 175301-803	24 V DC	<b>151717</b>	<b>MEB-LD-12-24DC</b>		
		230 V AC	<b>151718</b>	<b>MEB-LD-230AC</b>		
	Plug pattern type B, industry standard	24 V DC	<b>19143</b>	<b>MF-LD-12-24DC</b>		
		230 V AC	<b>19144</b>	<b>MF-LD-230AC</b>		

1) Plug socket 230 V AC can be used for 24 V DC without LED configuration.

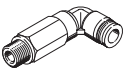
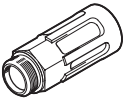
## Accessories

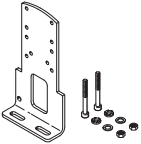
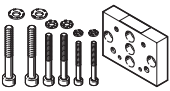
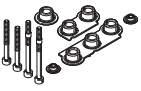
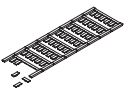

Ordering data	Description	Part no.	Type	PU <sup>1)</sup>	
<b>Push-in fitting with internal hex</b>					
	Connecting thread 10-32 UNF for tubing O.D.	5/32 "	572312	QBM-10-32-UNF-5/32-I-U	10
	Connecting thread 1/4 NPT for tubing O.D.	1/4 "	572320	QB-1/4-1/4-I-U	10
		5/16 "	572321	QB-1/4-5/16-I-U	10
		3/8 "	572322	QB-1/4-3/8-I-U	10
<b>Angled push-in fitting, with external hex</b>					
	Connecting thread 1/4 NPT for tubing O.D.	1/4 "	533295	QBL-1/4-1/4-U	10
		5/16 "	533296	QBL-1/4-5/16-U	10
		3/8 "	533297	QBL-1/4-3/8-U	5
<b>Angled push-in fitting, long, with external hex</b>					
	Connecting thread 1/4 NPT for tubing O.D.	1/4 "	564674	QBL-1/4-1/4-U	10
		5/16 "	564675	QBL-1/4-5/16-U	10
		3/8 "	564676	QBL-1/4-3/8-U	5
<b>Silencer</b>					
	With connecting thread NPT, metal design	1/4 NPT	12639	U-1/4-B-NPT	1
	With connecting thread NPT, sintered design, long	1/4 NPT	1206990	AMTE-M-LH-N14	20

1) Packaging unit

Ordering data	Description	Weight [g]	Part no.	Type
<b>Foot mounting</b>				
	With screw set for attaching the valve to the foot mounting	130	2293485	VAME-B10-25-A
<b>Wall mounting</b>				
	With screw set for attaching the valve to the wall mounting	53	576413	VAME-B10-20-W
<b>Assortment of spare parts</b>				
	Set comprising seals and screws	12	8035636	VAME-B10-25-MK
<b>Inscription label</b>				
	Frame with 40 labels	-	565306	ASLR-C-E4



## Datasheet

-  - Flow rate  
up to 1800 l/min ( $\pm 20\%$ )
-  - Valve width  
31 mm
-  - Voltage  
24 V DC

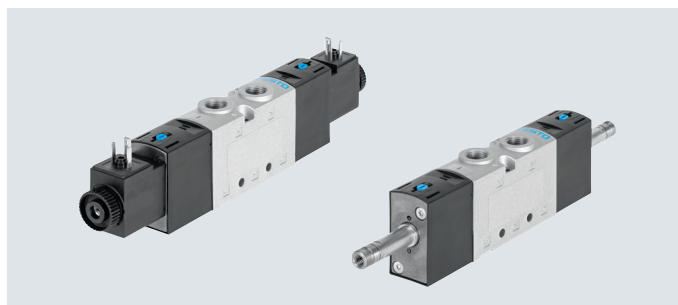

General technical data								
Valve function		3/2-way valve					5/2-way valve	
Order code for valves		M32C	M32U	T32C	T32U	T32H	M52	B52
Valve width	[mm]	31						
Nominal width	[mm]	7.9	7.9	7.9	7.8	7.8	8.1	8.7
Design		Poppet seat						
Flow direction		Not reversible						
Pilot air supply		Internal						
Type of control		Piloted						
Manual override		Non-detenting, detenting						
Overlap		Negative overlap						
Sealing principle		Soft						
Type of mounting		Optionally via through-hole or on manifold rail						
Standard nominal flow rate q <sub>N</sub>	[l/min]	1600					1800	
Actuation type		Electrical						
Mounting position		Any						
Exhaust air function		Can be throttled						
Connection for venting hole		Not ducted						
b value		0.4	0.2	0.4	0.3	0.3	0.3	0.3
c value	[l/sbar]	6.0	7.0	6.0	6.7	6.7	9.9	9.9
Pneumatic port	1, 2, 3	3/8 NPT	3/8 NPT	3/8 NPT	3/8 NPT	3/8 NPT	3/8 NPT	3/8 NPT
	4, 5	–	–	3/8 NPT	3/8 NPT	3/8 NPT	3/8 NPT	3/8 NPT
Pilot exhaust air port 82, 84		10-32 UNF-2B						

ATEX	
Type	VUVS-LT-...-EX2
ATEX category for gas	II 3G
Type of (ignition) protection for gas	Ex ec IIC T4 Gc X
ATEX category for dust	II 3D
Type of ignition protection for dust	Ex tc IIIC T115°C Dc X
Explosion-proof ambient temperature [°C]	10 °C ≤ T <sub>a</sub> ≤ +60 °C
CE marking (see declaration of conformity) <sup>1)</sup>	To EU Explosion Protection Directive (ATEX)
UKCA marking (see declaration of conformity) <sup>1)</sup>	To UK explosion regulations
Explosion protection certification outside the EU	EPL Dc (GB)
	EPL Gc (GB)

- 1) For information about the area of use, see the declaration of conformity at: [www.festo.com/catalogue/...](http://www.festo.com/catalogue/...) → Support/Downloads.  
If the devices are subject to usage restrictions in residential, commercial or light-industrial environments, further measures for the reduction of the emitted interference may be necessary.

## Datasheet

Technical data								
Order code for valves	M32C	M32U	T32C	T32U	T32H	M52	B52	
Normal position	Closed	Open	2x normally closed	2x normally open	1x open/ 1x closed	–	–	
Stable position	Monostable	Monostable	Monostable	Monostable	Monostable	Monostable	Bistable	
Reset method	Mechanical spring		Mechanical spring			Mechanical spring	–	
Switching times in [ms]	On	13	14	13	14	13	17	–
	Off	32	36	33	35	37	26	–
	Change-over	–	–	–	–	–	–	13
Product weight without solenoid coil	[g]	305	305	422	422	422	432	438

Safety characteristics		
Max. positive test pulse with logic 0	[µs]	2000 (valves with VACF)
Max. negative test pulse with logic 1	[µs]	3600 (valves with VACF)
Shock resistance	Shock test with severity level 2 to FN 942017-5 and EN 60068-2-27	
Vibration resistant	Transport application test with severity level 2 to FN 942017-4 and EN 60068-2-6	

Operating and environmental conditions									
Order code for valves	M32C	M32U	T32C	T32U	T32H	M52	B52		
Operating medium	Compressed air to ISO 8573-1:2010 [7:4:4]								
Pilot medium	Compressed air to ISO 8573-1:2010 [7:4:4]								
Note on the operating/pilot medium	Lubricated operation possible (in which case lubricated operation will always be required)								
Cleanroom class	ISO class 6								
Operating pressure	[MPa]	0.25 ... 1				0.25 ... 1		0.15 ... 1	
	[bar]	2.5 ... 10				2.5 ... 10		1.5 ... 10	
Pilot pressure	[MPa]	0.25 ... 1				0.25 ... 1		0.15 ... 1	
	[bar]	2.5 ... 10				2.5 ... 10		1.5 ... 10	
Ambient temperature	[°C]	–10 ... +60							
Temperature of medium	[°C]	–10 ... +60							
Certification	c UL us - Recognized (OL)								
Corrosion resistance class CRC <sup>1)</sup>	2								

1) More information [www.festo.com/x/topic/crc](http://www.festo.com/x/topic/crc)

Electrical data	
Electrical connection	Via solenoid coil
Operating voltage	[V DC] → Internet: vacf
Permitted voltage fluctuations	[%]
Power	[W]
Duty cycle	[%]
Degree of protection to EN 60529	

Materials								
Order code for valves	M32C	M32U	T32C	T32U	T32H	M52	B52	
Housing	Die-cast aluminium (painted)							
Seals	HNBR, NBR, TPE-U(PU)							
Piston spool	Wrought aluminium alloy					POM	POM	
Screws	Galvanised steel							
Note on materials	RoHS-compliant							

Datasheet

Dimensions

Download CAD data → [www.festo.com](http://www.festo.com)

3/2-way valves, with solenoid coil

3/2-way valves, without solenoid coil

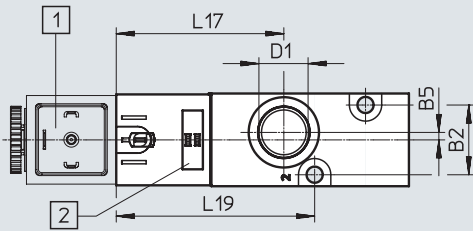
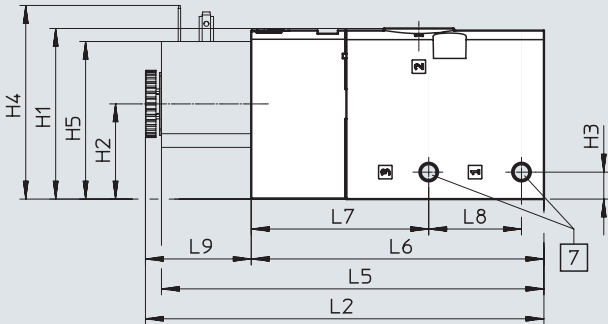
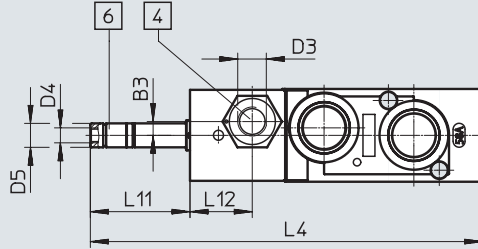
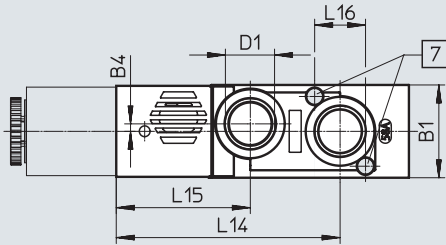

- [1] Solenoid coil
- [2] Space for inscription label
- [4] Port 10/12 for pilot air supply
- [6] Port 82 for pilot exhaust air
- [7] For screw M5

Type	B1	B2	B3	B4	B5	D1	D3	D4	D5 ∅	H1	H2	H3	H4	H5
VUVS-LT30-M32.....D-N38-...	31	23.3	-	2.5	2.5	3/8 NPT	-	10-32 UNF-2B	8	57	31.8	9	64.7	52.6

Type	L2	L4	L5	L6	L7	L8	L9	L11	L12	L14	L15	L16	L17	L19
VUVS-LT30-M32.....D-N38-...	133.2	131.1	127.8	97.8	59.3	31	35.4	33.3	-	74.8	44.8	17	56	66.3

Datasheet

Dimensions

Download CAD data → [www.festo.com](http://www.festo.com)

5/2-way single solenoid valves, with solenoid coil

5/2-way single solenoid valves, without solenoid coil

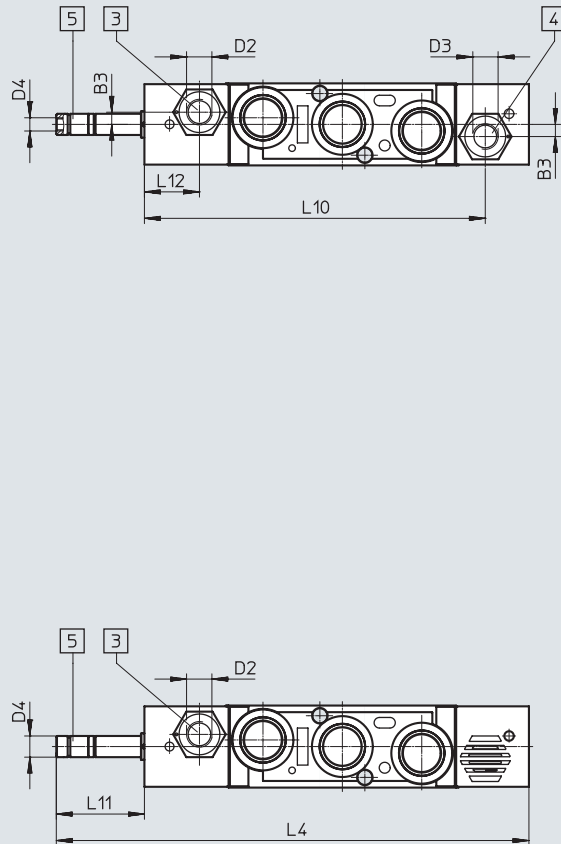
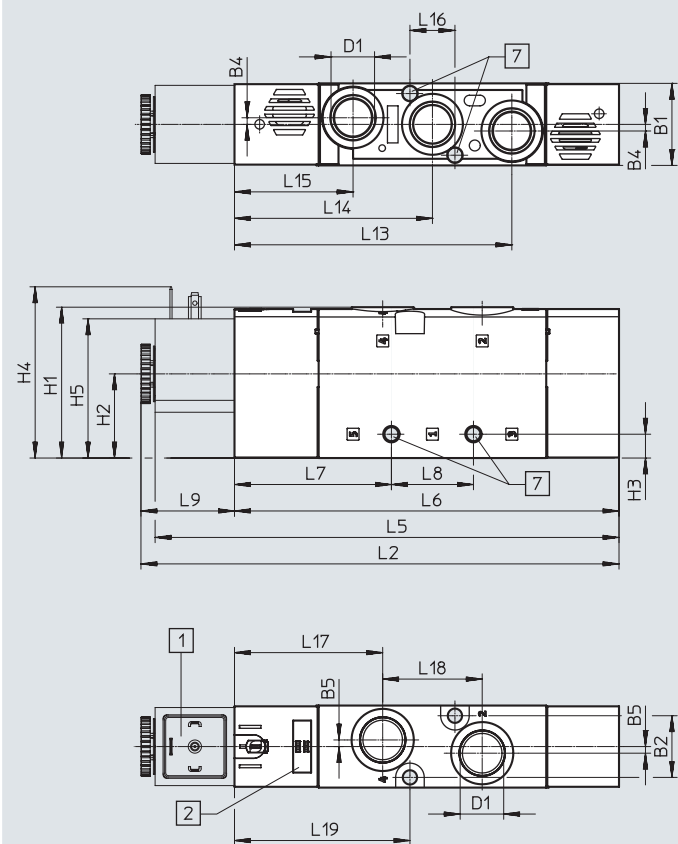

- [1] Solenoid coil
- [2] Space for inscription label
- [3] Port 14 for pilot air supply
- [4] Port 12 for pilot air supply
- [5] Port 84 for pilot exhaust air
- [7] For screw M5

Type	B1	B2	B3	B4	B5	D1	D2	D3	D4	D5 Ø	H1	H2	H3	H4	H5
VUVS-LT30-M52-...D-N38-...	31	23.3	-	2.5	2.5	3/8 NPT	-	-	10-32 UNF-2B	8	57	31.8	9	64.7	52.6

Type	L2	L4	L5	L6	L7	L8	L9	L10	L11	L12	L13	L14	L15	L16	L17	L18	L19
VUVS-LT30-M52-...D-N38-...	180.7	178.6	179.6	145.3	59.3	31	35.4	-	33.3	-	104.8	74.8	44.8	17	56	37.6	66.3

Datasheet

Dimensions

Download CAD data → [www.festo.com](http://www.festo.com)

2x 3/2-way valves and 5/2-way double solenoid valves, with solenoid coil

2x 3/2-way valves and 5/2-way double solenoid valves, without solenoid coil

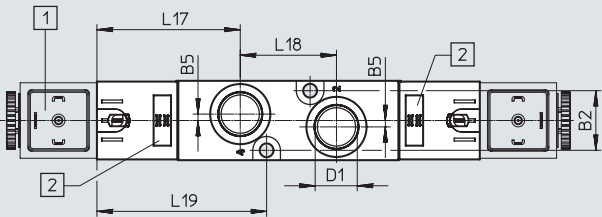
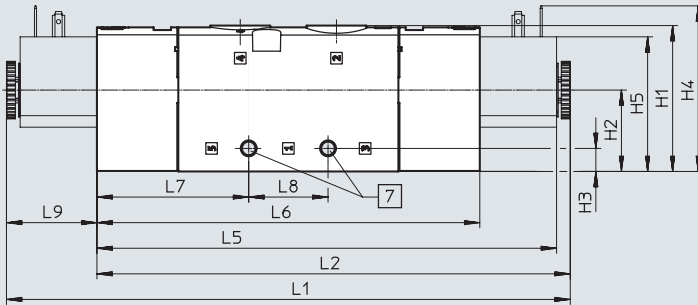
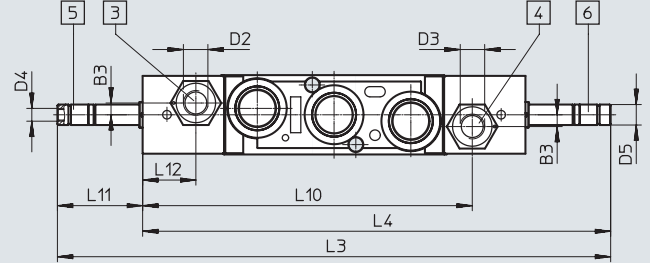
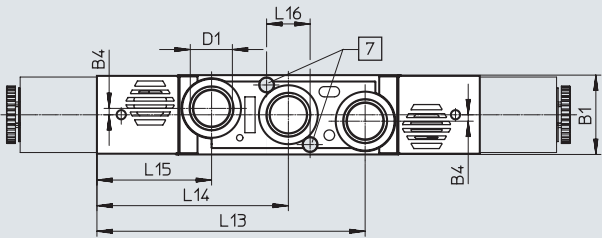

- [1] Solenoid coil
- [2] Space for inscription label
- [3] Port 14 for pilot air supply
- [4] Port 12 for pilot air supply
- [5] Port 84 for pilot exhaust air
- [6] Port 82 for pilot exhaust air
- [7] For screw M5

Type	B1	B2	B3	B4	B5	D1	D2	D3	D4	D5	H1	H2	H3	H4	H5
VUVS-LT30-T32...-MD-N38-...	31	23.3	-	2.5	2.5	3/8 NPT	-	-	10-32 UNF-2B	8	57	31.8	9	64.7	52.6
VUVS-LT30-B52-D-N38-...															

Type	L1	L2	L3	L4	L5	L6	L7	L8	L9	L10
VUVS-LT30-T32...-MD-N38-...	220.3	185	216.2	182.9	179.6	149.6	59.3	31	35.4	-
VUVS-LT30-B52-D-N38-...										

Type	L11	L12	L13	L14	L15	L16	L17	L18	L19
VUVS-LT30-T32...-MD-N38-...	33.3	-	104.8	74.8	44.8	17	56	37.6	66.3
VUVS-LT30-B52-D-N38-...									

Accessories

Dimensions

Download CAD data → [www.festo.com](http://www.festo.com)

Foot mounting

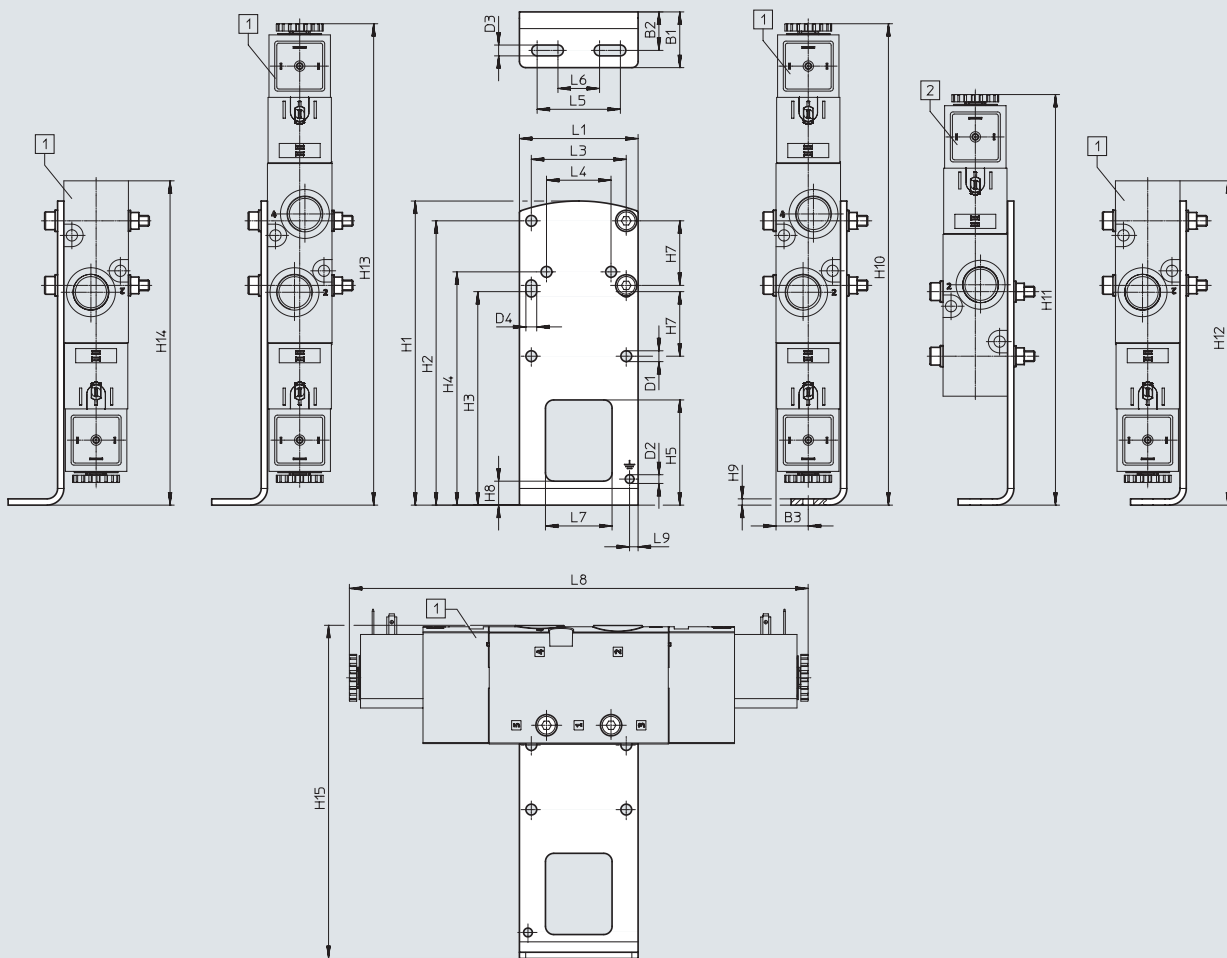

[1] VUVS-LT30-B52  
 VUVS-LT30-T32  
 VUVS-LT30-M52  
 VUVS-LT30-M32

[2] VUVS-LT30-M52,  
 VUVS-LT30-M32

Type		B1	B2	B3	D1 ∅	D2 ∅	D3	D4	H1	H2	H3
VAME-B10-30-A	VUVS-LT30-B52/T32	26.8	18.5	15.5	5.2	4.2	5.2	5.2	146	136.5	102.5
	VUVS-LT30-M52										
	VUVS-LT30-M32										

Type		H4	H5	H7	H8	H9	H10	H11	H12	H13	H14
VAME-B10-30-A	VUVS-LT30-B52/T32	112	50.5	31	11.5	3	231.2	–	231.2	231.2	231.2
	VUVS-LT30-M52							197.2	191.5		191.5
	VUVS-LT30-M32							144	144		144

Type		H15	L1	L3	L4	L5	L6	L7	L8	L9
VAME-B10-30-A	VUVS-LT30-B52/T32	160	57	45.6	31	40	20	32	220.3	4.1
	VUVS-LT30-M52								180.7	
	VUVS-LT30-M32								133.2	

Accessories

Dimensions

Download CAD data → [www.festo.com](http://www.festo.com)

Wall mounting

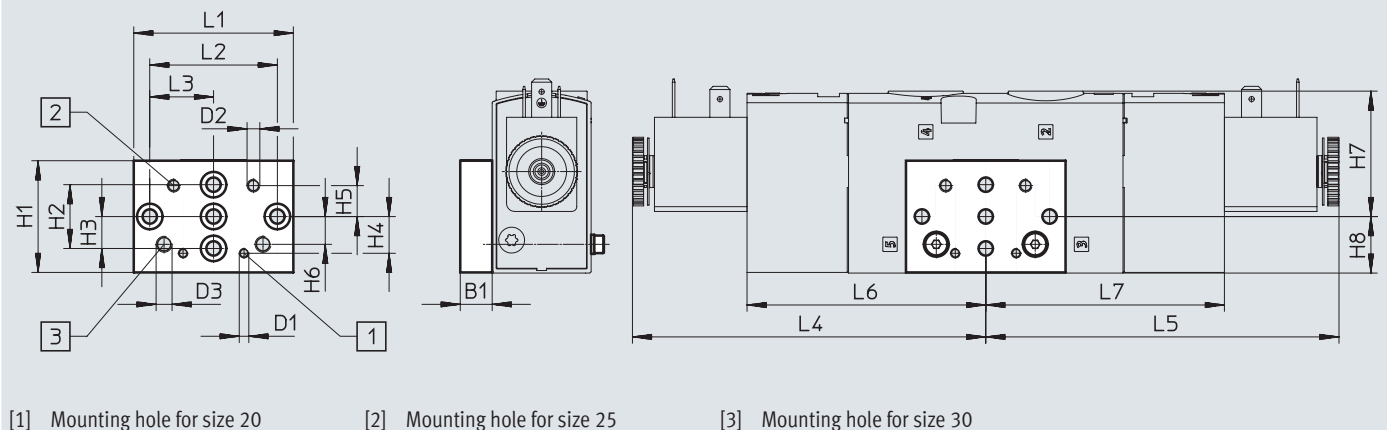

Type		B1	D1	D2	D3	H1	H2	H3	H4	H5	H6
VAME-B10-20-W	VUVS-LT30-B52/T32	10	M3	M4	M5	35	20	10	11.5	9.7	8.7
	VUVS-LT30-M52										
	VUVS-LT30-M32										





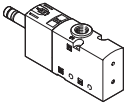
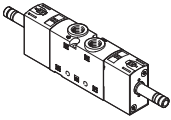
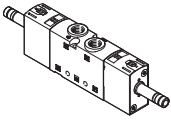
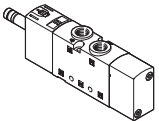
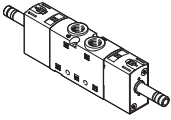

Type		H7	H8	L1	L2	L3	L4	L5	L6	L7
VAME-B10-20-W	VUVS-LT30-B52/T32	39.3	17.7	50	40	20	110.2	110.2	74.8	74.8
	VUVS-LT30-M52							70.5		-
	VUVS-LT30-M32							23		-

## Accessories





Ordering data		Code	Valve function	Part no.	Type
<b>3/2-way valve without solenoid coil</b>					
	<b>Single solenoid, normally closed</b>				
	M32C-M	Mechanical spring return, internal pilot air supply, flow direction not reversible	8036721	VUVS-LT30-M32C-MD-N38-F8	
	<b>Single solenoid, normally open</b>				
	M32U-M	Mechanical spring return, internal pilot air supply, flow direction not reversible	8036723	VUVS-LT30-M32U-MD-N38-F8	
<b>2x 3/2-way valve without solenoid coil</b>					
	<b>Single solenoid, normally closed</b>				
	T32C	Mechanical spring return, internal pilot air supply, flow direction not reversible	8036729	VUVS-LT30-T32C-MD-N38-F8	
	<b>Single solenoid, normally open</b>				
T32U	Mechanical spring return, internal pilot air supply, flow direction not reversible	8036731	VUVS-LT30-T32U-MD-N38-F8		
<b>Single solenoid, 1x normally open, 1x normally closed</b>					
T32H	Mechanical spring return, internal pilot air supply, flow direction not reversible	8036733	VUVS-LT30-T32H-MD-N38-F8		
<b>5/2-way valve without solenoid coil</b>					
	<b>Single solenoid</b>				
	M52	Mechanical spring return, internal pilot air supply, flow direction not reversible	8036725	VUVS-LT30-M52-MD-N38-F8	
	<b>Double solenoid</b>				
	B52	Internal pilot air supply, flow direction not reversible	8036727	VUVS-LT30-B52-D-N38-F8	



## Accessories



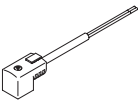

Ordering data		Description	Part no.	Type		
<b>Solenoid coils for valves</b>						
	Plug pattern type C, to DIN EN 175301-803	12 V DC	8030810	VACF-B-C1-5		
		24 V DC	8030811	VACF-B-C1-1		
		48 V DC	8030812	VACF-B-C1-7		
		24 V AC/50-60 Hz	8030813	VACF-B-C1-1A		
		48 V AC/50-60 Hz	8030814	VACF-B-C1-7A		
		110/120 V AC/50-60 Hz	8030815	VACF-B-C1-16B		
		230/240 V AC/50-60 Hz	8030817	VACF-B-C1-3W		
	Plug pattern type C, industry standard	24 V DC	8153947	VACF-B-E1-1		
	Plug pattern type B, industry standard	12 V DC	8030801	VACF-B-B2-5		
		24 V DC	8030802	VACF-B-B2-1		
		48 V DC	8030803	VACF-B-B2-7		
		24 V AC/50-60 Hz	8030804	VACF-B-B2-1A		
		48 V AC/50-60 Hz	8030805	VACF-B-B2-7A		
		110/120 V AC/50-60 Hz	8030806	VACF-B-B2-16B		
		230/240 V AC/50-60 Hz	8030808	VACF-B-B2-3W		
	Plug pattern type A, to EN 175301-803	12 V DC	8030821	VACF-A-A1-5		
		24 V DC	8030822	VACF-A-A1-1		
		48 V DC	8030823	VACF-A-A1-7		
		24 V AC/50-60 Hz	8030824	VACF-A-A1-1A		
		48 V AC/50-60 Hz	8030825	VACF-A-A1-7A		
		110/120 V AC/50-60 Hz	8030826	VACF-A-A1-16B		
		230/240 V AC/50-60 Hz	8030828	VACF-A-A1-3W		
	Single plug M8, 3-pin	24 V DC	8135909	VACS-C-R8-1RAL		
	Single plug M8, 4-pin	24 V DC	8135910	VACS-C-R1-1RAL		
	Single plug M12, A-coded, to EN 61076-2-101	24 V DC	8194567	VACS-C-R3-1RAL		
	Single plug M12, A-coded, pin assignment to DESINA	24 V DC	8135911	VACS-C-R4-1RAL		
<b>Seal set for solenoid coil</b>						
	Plug pattern type B to guarantee degree of protection IP67		8034609	VAMC-B10-B-B-S8		
	Plug pattern type A to guarantee degree of protection IP67		8034611	VAMC-B10-A-B-S8		
<b>Cover cap</b>						
	For manual override, non-detenting or covered		8028240	VAMC-B10-20-CH2		
<b>Plug socket</b>						
	<b>Plug pattern type C, to DIN EN 175301-803</b>					
	3-pin, screw terminal	Cable connector M12	0 ... 250 V AC/DC	IP65	539712	MSSD-EB-M12
		Cable connector Pg7			151687	MSSD-EB
	3-pin, angled socket	Cable connector M12	0 ... 24 V DC	IP65	570367	MSSD-EB-M12-24VDC-SD-EX
	<b>Plug pattern type B, industry standard</b>					
	3-pin, screw terminal	Cable connector M16	0 ... 250 V AC/DC	IP65	539710	MSSD-F-M16
Cable fitting Pg9		34431			MSSD-F	

## Accessories

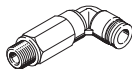
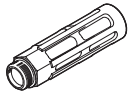

Ordering data		Description	Part no.	Type	
<b>Plug socket</b>					
	<b>Plug pattern type A, to EN 175301-803</b>				
	3-pin, angled socket	Cable fitting Pg9	0 ... 250 V AC/DC	IP65	<b>34583</b> <b>MSSD-C</b>
	3-pin, angled socket	Cable connector M16	0 ... 250 V AC/DC	IP65	<b>539709</b> <b>MSSD-C-M16</b>
<b>Adapter</b>					
	Socket type C, to EN 175301-803	Plug M12x1, 2-pin, A-coded	12 ... 24 V AC/DC	IP65	<b>188024</b> <b>MSSD-EB-M12-MONO</b>
<b>Plug socket with cable</b>					
	<b>Plug pattern type C, to EN 175301-803</b>				
	Angled socket, 3-pin Cable, open end, 3-core	24 V DC	LED	2.5 m	<b>151688</b> <b>KMEB-1-24-2.5-LED</b>
				5 m	<b>151689</b> <b>KMEB-1-24-5-LED</b>
				10 m	<b>193457</b> <b>KMEB-1-24-10-LED</b>
		230 V AC <sup>1)</sup>	–	2.5 m	<b>151690</b> <b>KMEB-1-230AC-2.5</b>
				5 m	<b>151691</b> <b>KMEB-1-230AC-5</b>
	<b>Plug pattern type B, industry standard</b>				
	Angled socket, 3-pin Cable, open end, 3-core	24 V DC	LED	2.5 m	<b>30935</b> <b>KMF-1-24DC-2.5-LED</b>
				5 m	<b>30937</b> <b>KMF-1-24DC-5-LED</b>
				10 m	<b>193458</b> <b>KMF-1-24-10-LED</b>
		230 V AC <sup>1)</sup>	–	2.5 m	<b>30936</b> <b>KMF-1-230AC-2.5</b>
				5 m	<b>30938</b> <b>KMF-1-230AC-5</b>
<b>Plug pattern type A, to EN 175301-803</b>					
Angled socket, 3-pin Cable, open end, 3-core	24 V DC	LED	2.5 m	<b>30931</b> <b>KMC-1-24DC-2.5-LED</b>	
			5 m	<b>30933</b> <b>KMC-1-24DC-5-LED</b>	
			10 m	<b>193459</b> <b>KMC-1-24-10-LED</b>	
	230 V AC <sup>1)</sup>	–	2.5 m	<b>30932</b> <b>KMC-1-230AC-2.5</b>	
			5 m	<b>30934</b> <b>KMC-1-230AC-5</b>	
<b>Illuminating seal</b>					
	Plug pattern type C, to DIN EN 175301-803	24 V DC	<b>151717</b>	<b>MEB-LD-12-24DC</b>	
		230 V AC	<b>151718</b>	<b>MEB-LD-230AC</b>	
	Plug pattern type B, industry standard	24 V DC	<b>19143</b>	<b>MF-LD-12-24DC</b>	
		230 V AC	<b>19144</b>	<b>MF-LD-230AC</b>	

1) Plug socket 230 V AC can be used for 24 V DC without LED configuration.

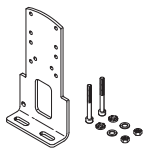
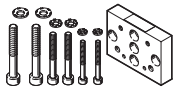

## Accessories

Ordering data		Description	Part no.	Type	PU <sup>1)</sup>
<b>Push-in fitting with internal hex</b>					
	Connecting thread 10-32 UNF for tubing O.D.	5/32 "	572312	QBM-10-32-UNF-5/32-I-U	10
	Connecting thread 3/8 NPT for tubing O.D.	5/16 "	572323	QB-3/8-5/16-I-U	10
		3/8 "	572324	QB-3/8-3/8-I-U	10
		1/2 "	572325	QB-3/8-1/2-I-U	10
<b>Angled push-in fitting, with external hex</b>					
	Connecting thread 3/8 NPT for tubing O.D.	5/16 "	533299	QBL-3/8-5/16-U	5
		3/8 "	533300	QBL-3/8-3/8-U	5
		1/2 "	533301	QBL-3/8-1/2-U	5
<b>Angled push-in fitting, long, with external hex</b>					
	Connecting thread 3/8 NPT for tubing O.D.	5/16 "	564679	QBLL-3/8-5/16-U	5
		3/8 "	564680	QBLL-3/8-3/8-U	5
		1/2 "	564681	QBLL-3/8-1/2-U	5
<b>Silencer</b>					
	With connecting thread NPT, metal design	3/8 NPT	12740	U-3/8-B-NPT	1
	With connecting thread NPT, sintered design, long	3/8 NPT	1206991	AMTE-M-LH-N38	10

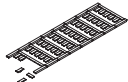
1) Packaging unit

Ordering data		Description	Weight [g]	Part no.	Type
<b>Foot mounting</b>					
	With screw set for attaching the valve to the foot mounting	239	8026337	VAME-B10-30-A	
<b>Wall mounting</b>					
	With screw set for attaching the valve to the wall mounting	53	576413	VAME-B10-20-W	
<b>Assortment of spare parts</b>					
	Set comprising seals and screws	22	8035637	VAME-B10-30-MK	
<b>Inscription label</b>					
	Frame with 40 labels	-	565306	ASLR-C-E4	

Datasheet

-  - Flow rate  
up to 700 l/min (±20%)
-  - Valve width  
21 mm
-  - Voltage  
12, 24 V DC  
24, 110, 120, 230, 240 V AC

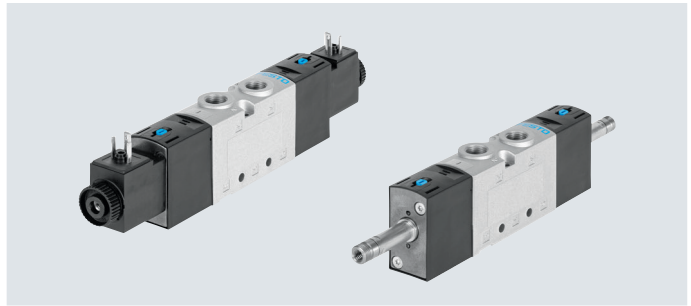

General technical data								
Valve function	3/2			5/2		5/3		
Order code for valves	M32C	M32U	M52	B52	P53C	P53U	P53E	
Valve width [mm]	21							
Design	Piston spool							
Flow direction	Reversible with external pilot air supply							
Pilot air supply	Internal or external							
Type of control	Piloted							
Manual override	Non-detenting, detenting							
Overlap	Positive overlap							
Sealing principle	Soft							
Type of mounting	Optionally via through-hole or on manifold rail							
Standard nominal flow rate qnN [l/min]	700					600		
Through-holes (nominal width) [mm]	5.7	5.7	5.7	5.7	5.0	4.8	4.5	
b value	0.35							
c value [l/sbar]	2.9	2.9	2.9	2.9	2.9	2.5	2.5	
Actuation type	Electrical							
Mounting position	Any							
Exhaust air function	Can be throttled							
Pneumatic port	1, 2, 3	1/8 NPT	1/8 NPT	1/8 NPT	1/8 NPT	1/8 NPT	1/8 NPT	1/8 NPT
	4, 5	–	–	1/8 NPT	1/8 NPT	1/8 NPT	1/8 NPT	1/8 NPT
Pilot exhaust air port 82/84	10-32 UNF-2B							

ATEX	
Type	VUVS-L-...EX2
ATEX category for gas	II 3G
Type of (ignition) protection for gas	Ex ec IICT4 Gc X
ATEX category for dust	II 3D
Type of ignition protection for dust	Ex tc IIIC T115°C Dc X
Explosion-proof ambient temperature [°C]	10 °C ≤ Ta ≤ +60 °C
CE marking (see declaration of conformity) <sup>1)</sup>	To EU Explosion Protection Directive (ATEX)
UKCA marking (see declaration of conformity) <sup>1)</sup>	To UK explosion regulations
Explosion protection certification outside the EU	EPL Dc (GB)
	EPL Gc (GB)

<sup>1)</sup> For information about the area of use, see the declaration of conformity at: [www.festo.com/catalogue/...](http://www.festo.com/catalogue/...) → Support/Downloads.  
If the devices are subject to usage restrictions in residential, commercial or light-industrial environments, further measures for the reduction of the emitted interference may be necessary.

## Datasheet

Technical data – 3/2-way valves					
Order code for valves		M32C		M32U	
Normal position		Closed		Open	
Stable position		Monostable		Monostable	
Reset method		Pneumatic spring	Mechanical spring	Pneumatic spring	Mechanical spring
Switching times in [ms]	On	14	14	14	15
	Off	21	32	21	28
	Change-over	–	–	–	–
Product weight without solenoid coil	[g]	138	136	138	136
Product weight with solenoid coil	[g]	172	170	172	170

Technical data – 5/2-way valves					
Order code for valves		M52		B52	
Normal position		–		–	
Stable position		Monostable		Bistable	
Reset method		Pneumatic spring	Mechanical spring	–	
Switching times in [ms]	On	20	12	–	
	Off	29	44	–	
	Change-over	–	–	10	
Product weight without solenoid coil	[g]	188	183	225	
Product weight with solenoid coil	[g]	222	217	259	

Technical data – 5/3-way valves					
Order code for valves		P53C		P53U	P53E
Normal position/mid-position		Closed		Pressurised	Exhausted
Stable position		Monostable			
Reset method		Mechanical spring			
Switching times in [ms]	On	13	13	13	
	Off	42	42	44	
	Change-over	24	21	24	
Product weight without solenoid coil	[g]	229	229	229	
Product weight with solenoid coil	[g]	263	263	263	

Safety characteristics		
Max. positive test pulse with logic 0	[µs]	1900 (valves with VACS-C-C1-1)
Max. negative test pulse with logic 1	[µs]	2700 (valves with VACS-C-C1-1)
Shock resistance		Shock test with severity level 2 to FN 942017-5 and EN 60068-2-27
Vibration resistant		Transport application test with severity level 2 to FN 942017-4 and EN 60068-2-6

## Datasheet

Operating and environmental conditions		M32	M52	B52	P53
Order code for valves					
Operating medium		Compressed air to ISO 8573-1:2010 [7:4:4]			
Pilot medium		Compressed air to ISO 8573-1:2010 [7:4:4]			
Note on the operating/pilot medium		Lubricated operation possible (in which case lubricated operation will always be required)			
Cleanroom class		ISO class 6			
Operating pressure with internal pilot air supply	[MPa]	0.25 ... 1		0.15 ... 1	0.25 ... 1
	[bar]	2.5 ... 10		1.5 ... 10	2.5 ... 10
Operating pressure with external pilot air supply	[MPa]	-0.09 ... +1			
	[bar]	-0.9 ... +10			
Pilot pressure	[MPa]	0.25 ... 1		0.15 ... 1	0.25 ... 1
	[bar]	2.5 ... 10		1.5 ... 10	2.5 ... 10
Ambient temperature	[°C]	-10 ... +60			
Temperature of medium	[°C]	-10 ... +60			
Certification		c UL us - Recognized (OL)			
Corrosion resistance class CRC <sup>1)</sup>		2			

1) More information [www.festo.com/x/topic/crc](http://www.festo.com/x/topic/crc)

Electrical data	
Electrical connection	Via solenoid coil
Operating voltage [V DC]	→ Internet: vacs
Permissible voltage fluctuations [%]	
Power [W]	
Duty cycle [%]	
Degree of protection to EN 60529	

Materials	
Housing	Die-cast aluminium (painted)
Seals	HNBR, NBR
Piston spool	Wrought aluminium alloy (P53 types: High-alloy stainless steel)
Screws	Galvanised steel
Note on materials	RoHS-compliant

Datasheet

Dimensions

Download CAD data → [www.festo.com](http://www.festo.com)

3/2-way valves, with solenoid coil

3/2-way valves, without solenoid coil

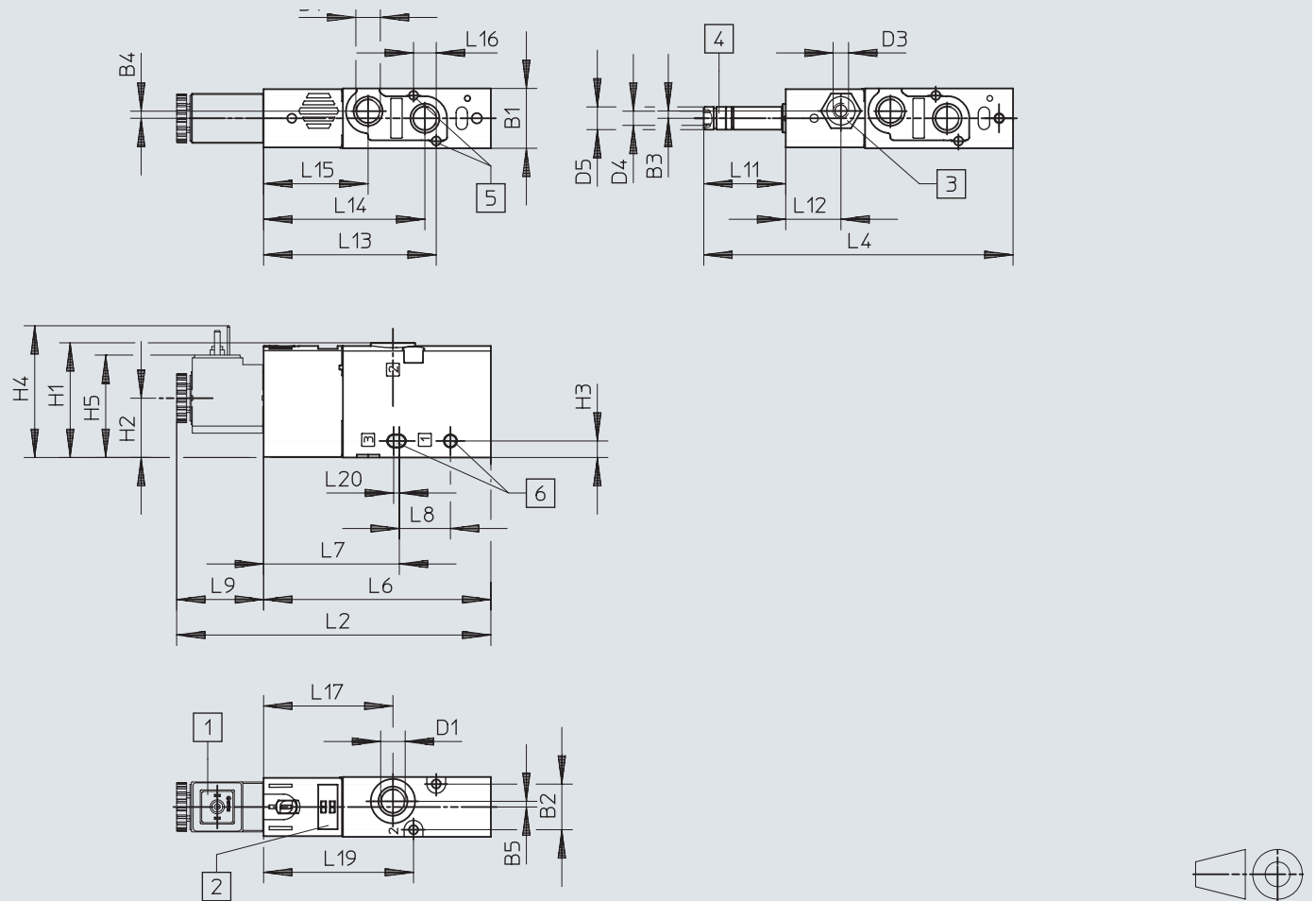

- [1] Solenoid coil interface type C
- [2] Space for inscription label
- [3] Port 10/12 for pilot air supply
- [4] Port 82 for pilot exhaust air
- [5] For screw M3
- [6] For screw M4

Type	B1	B2	B3	B4	B5	D1	D3	D4	D5 ∅	H1	H2	H3	H4	H5
VUVS-L20-M32-...D-N18-...	21.1	16.1	–	2.5	2	1/8 NPT	–	10-32 UNF-2B	8	40.4	20.9	5.8	46.7	36.4
VUVS-L20-M32-...ZD-N18-...			2.6					10-32 UNF-2B						

Type	L2	L4	L6	L7	L8	L9	L11	L12	L13	L14	L15	L16	L17	L19	L20
VUVS-L20-M32-...D-N18-...	110.7	109.1	80.1	47.9	18	30.6	29	–	60.9	56.9	36.9	8	45.6	52.9	2
VUVS-L20-M32-...ZD-N18-...								19.5							

Datasheet

Dimensions

Download CAD data → [www.festo.com](http://www.festo.com)

5/2-way valves, with solenoid coil

5/2-way valves, without solenoid coil

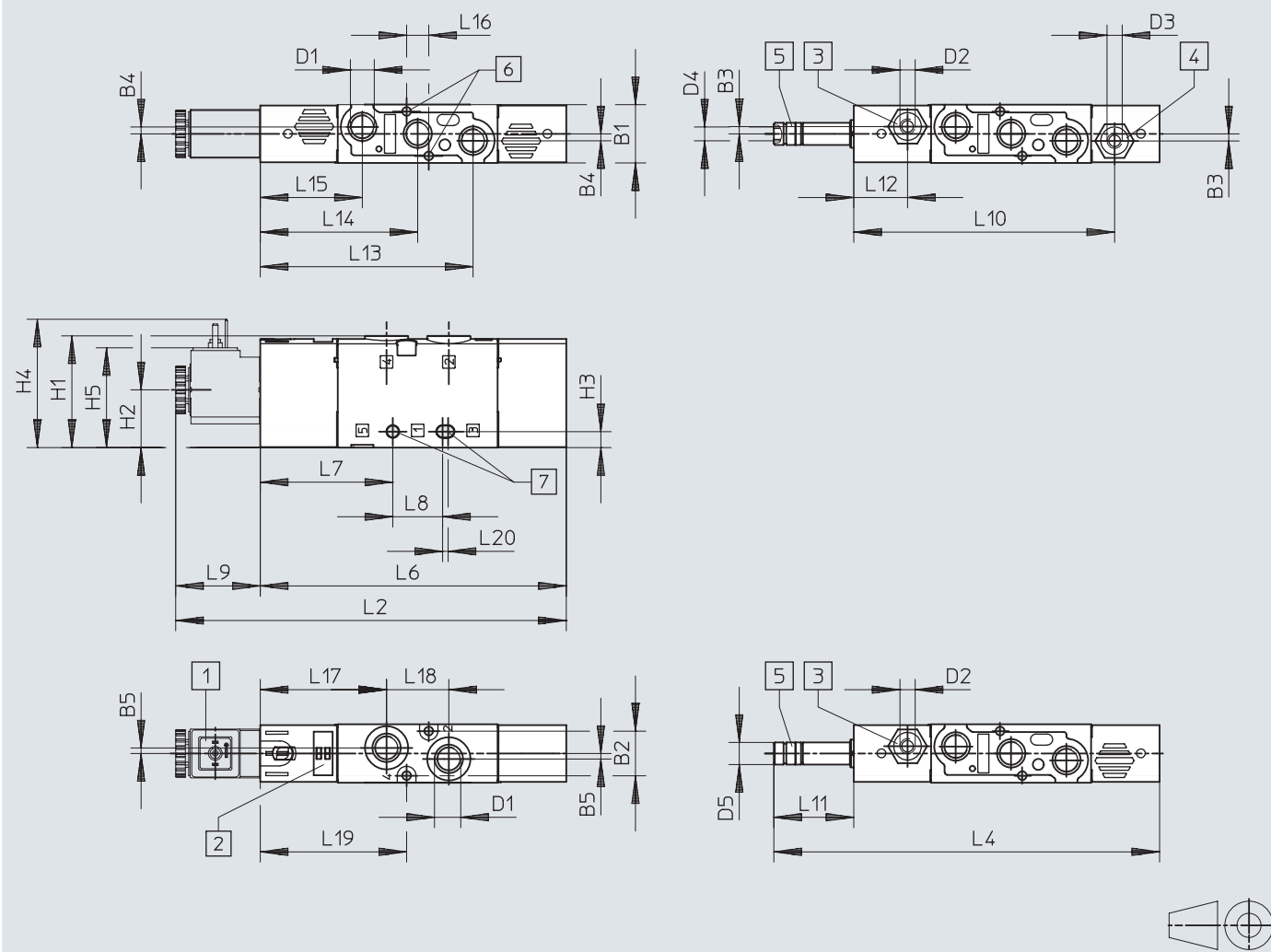

- [1] Solenoid coil interface type C
- [2] Space for inscription label
- [3] Port 14 for pilot air supply
- [4] Port 12 for pilot air supply
- [5] Port 84 for pilot exhaust air
- [6] For screw M3
- [7] For screw M4

Type	B1	B2	B3	B4	B5	D1	D2	D3	D4
VUVS-L20-M52-...D-N18-...	21.1	16.1	-	2.5	2	1/8 NPT	-	-	10-32 UNF-2B
VUVS-L20-M52-...ZD-N18-...			2.6				10-32 UNF-2B	10-32 UNF-2B	

Type	D5 ∅	H1	H2	H3	H4	H5	L2	L4	L6	L7	L8	L9
VUVS-L20-M52-...D-N18-...	8	40.4	20.9	5.8	46.7	36.4	141.2	139.6	110.6	47.9	18	30.6
VUVS-L20-M52-...ZD-N18-...												

Type	L10	L11	L12	L13	L14	L15	L16	L17	L18	L19	L20
VUVS-L20-M52-...D-N18-...	-	29	-	76.9	56.9	36.9	8	45.6	22.5	52.9	2
VUVS-L20-M52-...ZD-N18-...	94.3		19.5								



Datasheet

Dimensions

Download CAD data → [www.festo.com](http://www.festo.com)

5/3-way valves and 5/2-way double solenoid valves, with solenoid coil

5/3-way valves and 5/2-way double solenoid valves, without solenoid coil

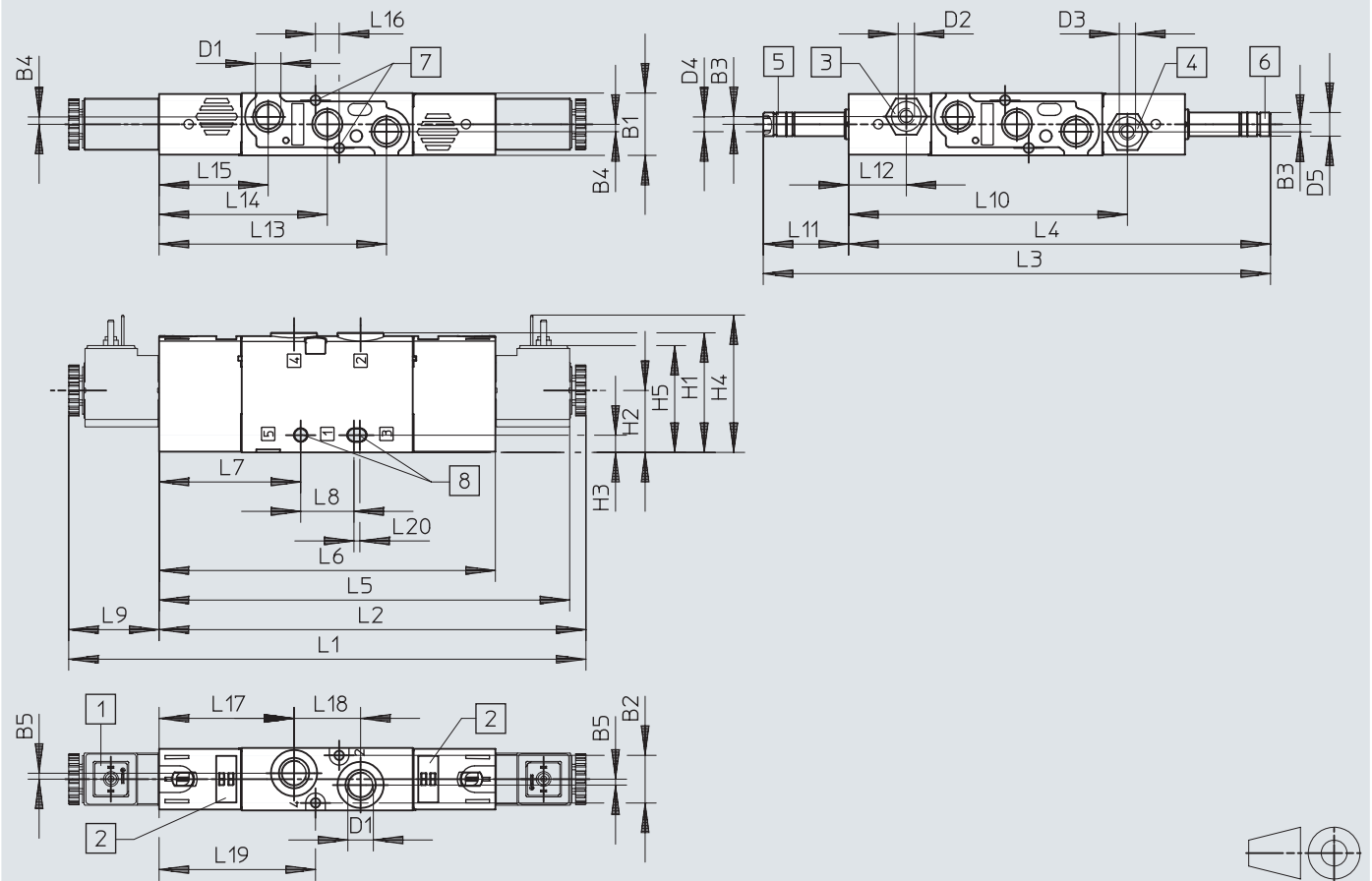

- [1] Solenoid coil interface type C
- [2] Space for inscription label
- [3] Port 14 for pilot air supply
- [4] Port 12 for pilot air supply
- [5] Port 84 for pilot exhaust air
- [6] Port 82 for pilot exhaust air
- [7] For screw M3
- [7] For screw M4

Type	B1	B2	B3	B4	B5	D1	D2	D3	D4	D5	H1	H2
VUVS-L20-P53-...D-N18-...	21.1	16.1	-	2.5	2	1/8 NPT	-	-	10-32 UNF-2B	8	40.4	20.9
VUVS-L20-P53-...ZD-N18-...			2.6				10-32 UNF-2B	10-32 UNF-2B				
VUVS-L20-B52-D-N18-...			-				-	-				
VUVS-L20-B52-ZD-N18-...			2.6				10-32 UNF-2B	10-32 UNF-2B				

Type	H3	H4	H5	L1	L2	L3	L4	L5	L6	L7	L8	L9	L10	L11
VUVS-L20-P53-...D-N18-...	5.8	46.7	36.4	174.9	144.3	171.7	142.7	139.1	113.7	47.9	18	30.6	-	29
VUVS-L20-P53-...ZD-N18-...													94.3	
VUVS-L20-B52-D-N18-...													-	
VUVS-L20-B52-ZD-N18-...													94.3	

Type	L12	L13	L14	L15	L16	L17	L18	L19	L20
VUVS-L20-P53-...D-N18-...	-	76.9	56.9	36.9	8	45.6	22.5	52.9	2
VUVS-L20-P53-...ZD-N18-...	19.5								
VUVS-L20-B52-D-N18-...	-								
VUVS-L20-B52-ZD-N18-...	19.5								

Datasheet

Dimensions

Foot mounting

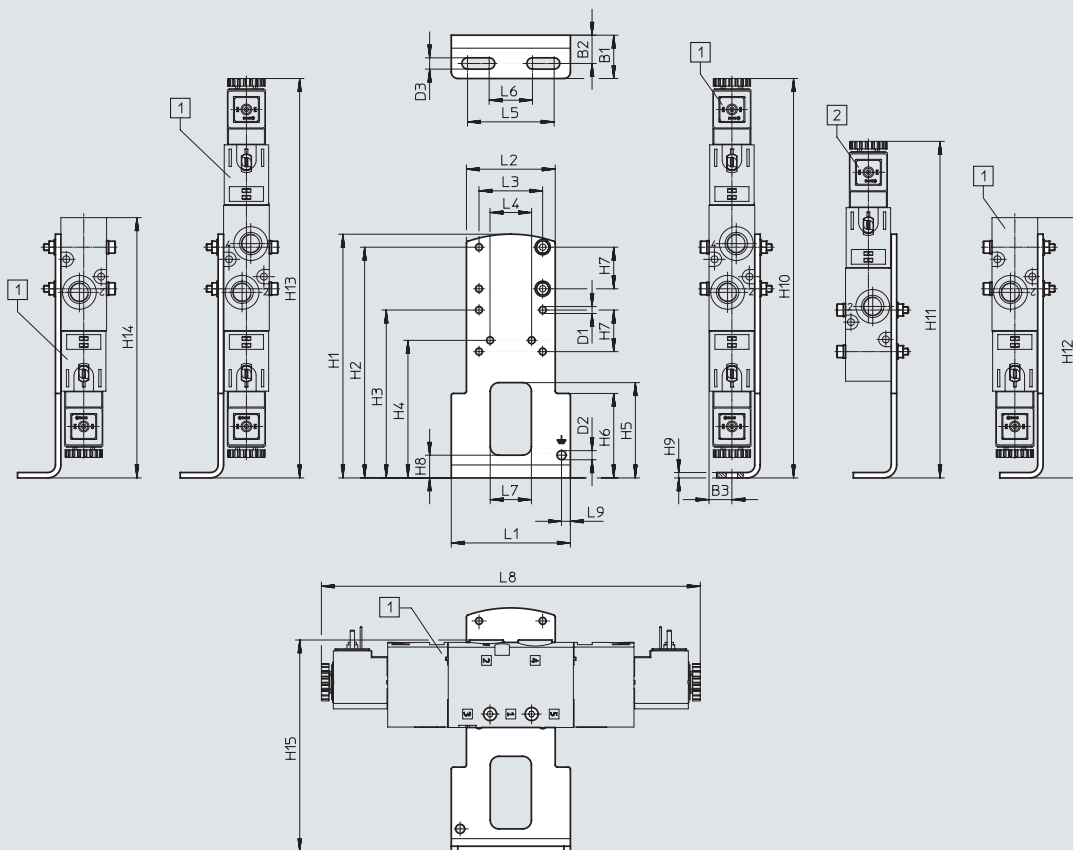

[1] VUVS-L20-B52,  
VUVS-L20-P53,  
VUVS-L20-M52,  
VUVS-L20-M32

[2] VUVS-L20-M52,  
VUVS-L20-M32

Type		B1	B2	B3	D1 ∅	D2 ∅	D3	H1	H2	H3	H4
VAME-B10-20-A	VUVS-L20-B52/P53	20	13.1	10.6	3.2	4.2	5.2	112.5	106.5	77.5	63.5
	VUVS-L20-M52										
	VUVS-L20-M32										

Type		H5	H6	H7	H8	H9	H10	H11	H12	H13	H14
VAME-B10-20-A	VUVS-L20-B52/P53	44	39	19.2	10.5	2.5	184.4	–	184.4	184.4	184.4
	VUVS-L20-M52							155.4	150.6	150.6	
	VUVS-L20-M32								120.2	120.2	

Type		H15	L1	L2	L3	L4	L5	L6	L7	L8	L9
VAME-B10-20-A	VUVS-L20-B52/P53	97.7	55	41	29.4	19.2	40	20	19	174.9	4.1
	VUVS-L20-M52									141.2	
	VUVS-L20-M32									110.7	

Datasheet

Dimensions

Wall mounting

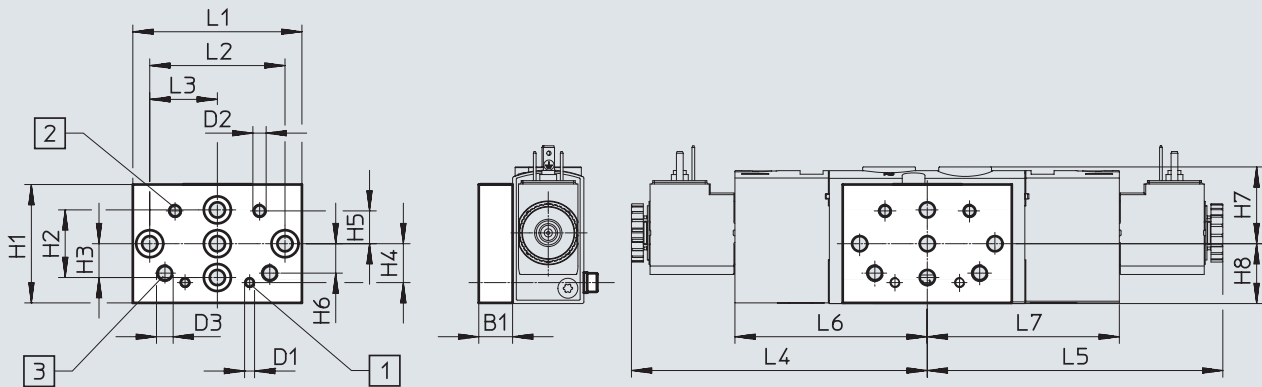

[1] Mounting hole for size 20

[2] Mounting hole for size 25

[3] Mounting hole for size 30







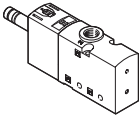
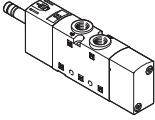
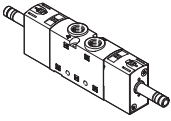
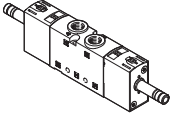

Type		B1	D1	D2	D3	H1	H2	H3	H4	H5	H6
VAME-B10-20-W	VUVS-L20-B52/P53	10	M3	M4	M5	35	20	10	11.5	9.7	8.7
	VUVS-L20-M52										
	VUVS-L20-M32										

Type		H7	H8	L1	L2	L3	L4	L5	L6	L7		
VAME-B10-20-W	VUVS-L20-B52/P53	22.7	17.7	50	40	20	87.5	87.4	56.9	56.9		
	VUVS-L20-M52										53.7	-
	VUVS-L20-M32										23.3	-

## Accessories







Ordering data		Code	Valve function	Part no.	Type
<b>3/2-way valve without solenoid coil</b>					
	<b>Single solenoid, closed</b>				
	M32C-A	Pneumatic spring return, internal pilot air supply, flow direction not reversible	575694	VUVS-L20-M32C-AD-N18-F7	
	M32C-AZ	Pneumatic spring return, external pilot air supply, reversible flow direction	8065570	VUVS-L20-M32C-AZD-N18-F7	
	M32C-M	Mechanical spring return, internal pilot air supply, flow direction not reversible	575695	VUVS-L20-M32C-MD-N18-F7	
	M32C-MZ	Mechanical spring return, external pilot air supply, reversible flow direction	8065571	VUVS-L20-M32C-MZD-N18-F7	
	<b>Single solenoid, open</b>				
M32U-A	Pneumatic spring return, internal pilot air supply, flow direction not reversible	575698	VUVS-L20-M32U-AD-N18-F7		
M32U-M	Mechanical spring return, internal pilot air supply, flow direction not reversible	575699	VUVS-L20-M32U-MD-N18-F7		
<b>5/2-way valve without solenoid coil</b>					
	<b>Single solenoid</b>				
	M52-A	Pneumatic spring return, internal pilot air supply, flow direction not reversible	575702	VUVS-L20-M52-AD-N18-F7	
	M52-AZ	Pneumatic spring return, external pilot air supply, reversible flow direction	8065574	VUVS-L20-M52-AZD-N18-F7	
	M52-M	Mechanical spring return, internal pilot air supply, flow direction not reversible	575704	VUVS-L20-M52-MD-N18-F7	
M52-MZ	Mechanical spring return, external pilot air supply, reversible flow direction	8065575	VUVS-L20-M52-MZD-N18-F7		
	<b>Double solenoid</b>				
	B52	Internal pilot air supply, flow direction not reversible	575706	VUVS-L20-B52-D-N18-F7	
B52-Z	External pilot air supply, reversible flow direction	8065576	VUVS-L20-B52-ZD-N18-F7		
<b>5/3-way valve without solenoid coil</b>					
	<b>Closed</b>				
	P53C-M	Mechanical spring return, internal pilot air supply, flow direction not reversible	575708	VUVS-L20-P53C-MD-N18-F7	
	P53C-MZ	Mechanical spring return, external pilot air supply, reversible flow direction	8065577	VUVS-L20-P53C-MZD-N18-F7	
	<b>Exhausted</b>				
	P53E	Mechanical spring return, internal pilot air supply, flow direction not reversible	575712	VUVS-L20-P53E-MD-N18-F7	
<b>Pressurised</b>					
P53U	Mechanical spring return, internal pilot air supply, flow direction not reversible	575710	VUVS-L20-P53U-MD-N18-F7		

## Accessories

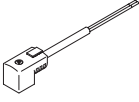
Ordering data		Description	Part no.	Type		
<b>Solenoid coils for valves</b>						
	Plug pattern type C, to DIN EN 175301-803	12 V DC	8025331	VACS-C-C1-5		
		24 V DC	8025330	VACS-C-C1-1		
		48 V DC	8025336	VACS-C-C1-7		
		24 V AC/50-60 Hz	8025335	VACS-C-C1-1A		
		48 V AC/50-60 Hz	8025337	VACS-C-C1-7A		
		110/120 V AC/50-60 Hz	8025334	VACS-C-C1-16B		
		230/240 V AC/50-60 Hz	8025338	VACS-C-C1-3W		
	Plug pattern type C, industry standard	24 V DC	8153948	VACS-C-E1-1		
	Single plug M8, 4-pin	24 V DC	8135906	VACS-C-R1-1L		
		Single plug M12, A-coded, to EN 61076-2-101	24 V DC	8135907	VACS-C-R3-1L	
		Single plug M12, A-coded, pin assignment to DESINA	24 V DC	8135908	VACS-C-R4-1L	
		Single plug M8, 3-pin	24 V DC	8135905	VACS-C-R8-1L	
			Single plug M8, 3-pin	24 V DC	8135909	VACS-C-R8-1RAL
Single plug M8, 4-pin	24 V DC			8135910	VACS-C-R1-1RAL	
Single plug M12, A-coded, to EN 61076-2-101	24 V DC			8194567	VACS-C-R3-1RAL	
Single plug M12, A-coded, pin assignment to DESINA	24 V DC			8135911	VACS-C-R4-1RAL	
<b>Seal set</b>						
	Plug pattern type C to guarantee degree of protection IP67		2643771	VAMC-B10-C-B-S8		
	Plug pattern type B to guarantee degree of protection IP67		8034609	VAMC-B10-B-B-S8		
<b>Cover cap</b>						
	For manual override, non-detenting or covered		8028240	VAMC-B10-20-CH2		
<b>Plug socket</b>						
	<b>Plug pattern type C, to DIN EN 175301-803</b>					
	3-pin, screw terminal	Cable connector M12	0 ... 250 V AC/DC	IP65	539712	MSSD-EB-M12
		Cable connector Pg7			151687	MSSD-EB
	3-pin, angled socket	Cable connector M12	0 ... 24 V DC	IP65	570367	MSSD-EB-M12-24VDC-SD-EX
	<b>Plug pattern type B, industry standard</b>					
	3-pin, screw terminal	Cable connector M16	0 ... 250 V AC/DC	IP65	539710	MSSD-F-M16
		Cable fitting Pg9			34431	MSSD-F
	<b>Plug pattern type A, to EN 175301-803</b>					
	3-pin, screw terminal	Cable connector M16	0 ... 250 V AC/DC	IP65	8037151	MSSD-C-EX
	<b>Adapter</b>					
	Socket type C, to EN 175301-803	Plug M12x1, 2-pin, A-coded	12 ... 24 V AC/DC	IP65	188024	MSSD-EB-M12-MONO

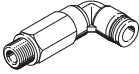
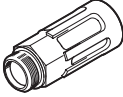

1) Plug socket 230 V AC can be used for 24 V DC without LED configuration.

## Accessories

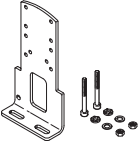
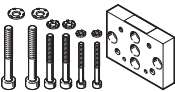
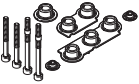

Ordering data		Description	Part no.	Type		
<b>Plug socket with cable</b>						
	<b>Plug pattern type C, to EN 175301-803</b>					
	Angled socket, 3-pin Cable, open end, 3-core	24 V DC	LED	2.5 m	151688	KMEB-1-24-2.5-LED
				5 m	151689	KMEB-1-24-5-LED
				10 m	193457	KMEB-1-24-10-LED
		230 V AC <sup>1)</sup>	–	2.5 m	151690	KMEB-1-230AC-2.5
				5 m	151691	KMEB-1-230AC-5
	<b>Plug pattern type B, industry standard</b>					
	Angled socket, 3-pin Cable, open end, 3-core	24 V DC	LED	2.5 m	30935	KMF-1-24DC-2.5-LED
				5 m	30937	KMF-1-24DC-5-LED
				10 m	193458	KMF-1-24-10-LED
		230 V AC <sup>1)</sup>	–	2.5 m	30936	KMF-1-230AC-2.5
				5 m	30938	KMF-1-230AC-5
<b>Illuminating seal</b>						
	Plug pattern type C, to DIN EN 175301-803	24 V DC		151717	MEB-LD-12-24DC	
		230 V AC		151718	MEB-LD-230AC	
	Plug pattern type B, industry standard	24 V DC		19143	MF-LD-12-24DC	
		230 V AC		19144	MF-LD-230AC	
<b>Ordering data</b>						
Ordering data		Description	Part no.	Type	PU <sup>1)</sup>	
<b>Push-in fitting with internal hex</b>						
	Connecting thread 10-32 UNF for tubing O.D.		5/32 "	572312	QBM-10-32-UNF-5/32-I-U	10
	Connecting thread 1/8 NPT for tubing O.D.		5/32 "	572317	QB-1/8-5/32-I-U	10
			1/4 "	572318	QB-1/8-1/4-I-U	10
			5/16 "	572319	QB-1/8-5/16-I-U	10
<b>Angled push-in fitting, with external hex</b>						
	Connecting thread 1/8 NPT for tubing O.D.		5/32 "	533290	QBL-1/8-5/32-U	10
			1/4 "	533292	QBL-1/8-1/4-U	10
			5/16 "	533293	QBL-1/8-5/16-U	10
<b>Angled push-in fitting, long, with external hex</b>						
	Connecting thread 1/8 NPT for tubing O.D.		5/32 "	564668	QBLL-1/8-5/32-U	10
			1/4 "	564670	QBLL-1/8-1/4-U	10
			5/16 "	564671	QBLL-1/8-5/16-U	10
<b>Silencer</b>						
	With connecting thread NPT, metal design		1/8 NPT	12638	U-1/8-B-NPT	1
		With connecting thread NPT, sintered design, long		1/8 NPT	1206989	AMTE-M-LH-N18

1) Packaging unit

## Accessories

Ordering data			Weight [g]	Part no.	Type
Description					
<b>Foot mounting</b>					
	With screw set for attaching the valve to the foot mounting		97	576412	VAME-B10-20-A
<b>Wall mounting</b>					
	With screw set for attaching the valve to the wall mounting (for size 20, 25, 30)		53	576413	VAME-B10-20-W
<b>Assortment of spare parts</b>					
	Set comprising seals and screws		10	8026203	VAME-B10-20-MK
<b>Inscription label</b>					
	Frame with 40 labels		–	565306	ASLR-C-E4
<b>Mounting kit</b>					
	With mounting bracket for lateral valve mounting	For standards-based cylinder DSBC-32...40	76	2568514	DAVM-MW-V1-32-V

Datasheet

-  Flow rate  
up to 1300 l/min (±20%)
-  Valve width  
26.5 mm
-  Voltage  
12, 24 V DC  
24, 110, 120, 230, 240 V AC

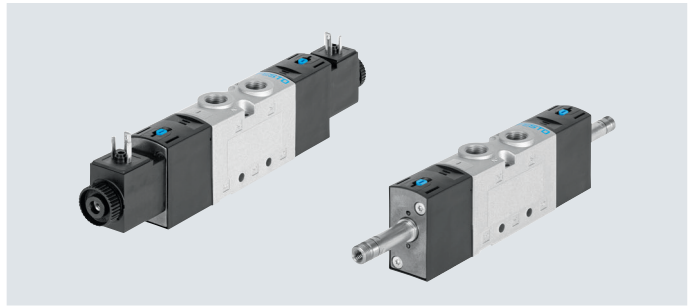

General technical data								
Valve function	3/2			5/2		5/3		
Order code for valves	M32C	M32U	M52	B52	P53C	P53U	P53E	
Valve width [mm]	26.5							
Design	Piston spool							
Flow direction	Reversible with external pilot air supply							
Pilot air supply	Internal or external							
Type of control	Piloted							
Manual override	Non-detenting, detenting							
Overlap	Positive overlap							
Sealing principle	Soft							
Type of mounting	Optionally via through-hole or on manifold rail							
Standard nominal flow rate qnN [l/min]	1000		1300	1300	1200	1000		
Through-holes (nominal width) [mm]	6.3	6.3	6.9	6.9	6.5	6.3	6.3	
b value	0.3	0.3	0.4	0.4	0.4	0.4	0.4	
c value [l/sbar]	4.7, 4.8 <sup>1)</sup>	4.2, 4.3 <sup>2)</sup>	5.3	5.6	5.2	4.3	4.3	
Actuation type	Electrical							
Mounting position	Any							
Exhaust air function	Can be throttled							
Connection for venting hole	Not ducted							
Pneumatic port 1, 2, 3	1/4 NPT	1/4 NPT	1/4 NPT	1/4 NPT	1/4 NPT	1/4 NPT	1/4 NPT	
4, 5	–	–	1/4 NPT	1/4 NPT	1/4 NPT	1/4 NPT	1/4 NPT	
Pilot exhaust air port 82/84	10-32 UNF-2B							

1) Mechanical spring return

ATEX	
Type	VUVS-L...-EX2
ATEX category for gas	II 3G
Type of (ignition) protection for gas	Ex ec IICT4 Gc X
ATEX category for dust	II 3D
Type of ignition protection for dust	Ex tc IIIC T115°C Dc X
Explosion-proof ambient temperature [°C]	-10°C ≤ Ta ≤ +60 °C
CE marking (see declaration of conformity) <sup>1)</sup>	To EU Explosion Protection Directive (ATEX)
UKCA marking (see declaration of conformity) <sup>1)</sup>	To UK explosion regulations
Explosion protection certification outside the EU	EPL Dc (GB)
	EPL Gc (GB)

1) For information about the area of use, see the declaration of conformity at: [www.festo.com/catalogue/...](http://www.festo.com/catalogue/...) → Support/Downloads.  
If the devices are subject to usage restrictions in residential, commercial or light-industrial environments, further measures for the reduction of the emitted interference may be necessary.



## Datasheet

Technical data – 3/2-way valves					
Order code for valves		M32C		M32U	
Normal position		Closed		Open	
Stable position		Monostable		Monostable	
Reset method		Pneumatic spring	Mechanical spring	Pneumatic spring	Mechanical spring
Switching times in [ms]	On	13	11	12	11
	Off	26	40	26	39
	Change-over	–	–	–	–
Product weight without solenoid coil	[g]	244	244	244	244
Product weight with solenoid coil	[g]	297	297	297	297

Technical data – 5/2-way valves					
Order code for valves		M52		B52	
Normal position		–		–	
Stable position		Monostable		Bistable	
Reset method		Pneumatic spring	Mechanical spring	–	
Switching times in [ms]	On	19	12	–	
	Off	35	47	–	
	Change-over	–	–	11	
Product weight without solenoid coil	[g]	311	311	322	
Product weight with solenoid coil	[g]	363	363	428	

Technical data – 5/3-way valves					
Order code for valves		P53C		P53U	P53E
Normal position/mid-position		Closed		Pressurised	Exhausted
Stable position		Monostable			
Reset method		Mechanical spring			
Switching times in [ms]	On	13	14	14	
	Off	42	48	48	
	Change-over	26	25	25	
Product weight without solenoid coil	[g]	324	324	324	
Product weight with solenoid coil	[g]	430	430	430	

Safety characteristics		
Max. positive test pulse with logic 0	[µs]	2000 (valves with VACF-B-...-1)
Max. negative test pulse with logic 1	[µs]	3600 (valves with VACF-B-...-1)
Shock resistance		Shock test with severity level 2 to FN 942017-5 and EN 60068-2-27
Vibration resistant		Transport application test with severity level 2 to FN 942017-4 and EN 60068-2-6

## Datasheet

Operating and environmental conditions		M32	M52	B52	P53
Order code for valves					
Operating medium		Compressed air to ISO 8573-1:2010 [7:4:4]			
Pilot medium		Compressed air to ISO 8573-1:2010 [7:4:4]			
Note on the operating/pilot medium		Lubricated operation possible (in which case lubricated operation will always be required)			
Cleanroom class		ISO class 6			
Operating pressure with internal pilot air supply	[MPa]	0.25 ... 1		0.15 ... 1	0.25 ... 1
	[bar]	2.5 ... 10		1.5 ... 10	2.5 ... 10
Operating pressure with external pilot air supply	[MPa]	-0.09 ... +1			
	[bar]	-0.9 ... +10			
Pilot pressure	[MPa]	0.25 ... 1		0.15 ... 1	0.25 ... 1
	[bar]	2.5 ... 10		1.5 ... 10	2.5 ... 10
Ambient temperature	[°C]	-10 ... +60			
Temperature of medium	[°C]	-10 ... +60			
Certification		c UL us - Recognized (OL)			
Maritime classification <sup>1)</sup>		See certificate (for VUVS-...-F8 and VUVS-...-F8-...-B2 only)			
Corrosion resistance class CRC <sup>2)</sup>		2			

1) More information [www.festo.com/catalogue/...](http://www.festo.com/catalogue/...) → Support/Downloads.

2) More information [www.festo.com/x/topic/crc](http://www.festo.com/x/topic/crc)

Electrical data	
Electrical connection	Via solenoid coil
Operating voltage [V DC]	→ Internet: vacf
Permitted voltage fluctuations [%]	
Power [W]	
Duty cycle [%]	
Degree of protection to EN 60529	

Materials	
Housing	Die-cast aluminium
Seals	HNBR, NBR
Piston spool	Wrought aluminium alloy
Screws	Galvanised steel
Note on materials	RoHS-compliant

Datasheet

Dimensions

Download CAD data → [www.festo.com](http://www.festo.com)

3/2-way valves, with solenoid coil

3/2-way valves, without solenoid coil

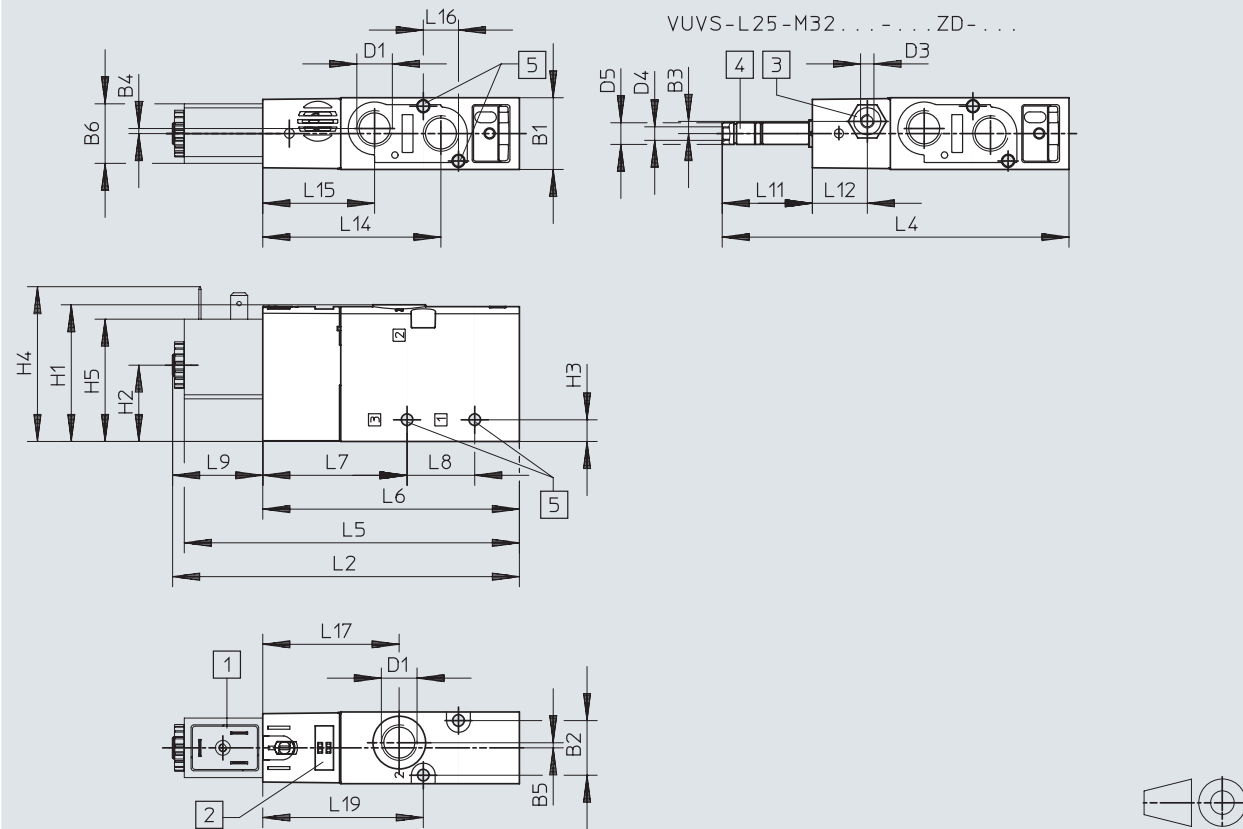

- [1] Solenoid coil interface type B/  
type C
- [2] Space for inscription label
- [3] Port 10/12 for pilot air supply
- [4] Port 82 for pilot exhaust air
- [5] For screw M4

Type	B1	B2	B3	B4	B5	B6	D1	D3	D4	D5 ∅	H1	H2	H3	H4	H5
VUVS-L25-M32-...D-N14-...	26.5	20.2	–	1.9	1.9	22	1/4 NPT	–	10-32 UNF-2B	8	50.5	28.2	8	57.2	45.2
VUVS-L25-M32-...ZD-N14-...			4.5					10-32 UNF-2B							

Type	L2	L4	L5	L6	L7	L8	L9	L11	L12	L14	L15	L16	L17	L19
VUVS-L25-M32-...D-N14-...	129.2	128.1	123.8	94.8	53.3	25	34.4	33.3	–	65.8	41.3	13	50.4	59.3
VUVS-L25-M32-...ZD-N14-...									20.3					

Datasheet

Dimensions

Download CAD data → [www.festo.com](http://www.festo.com)

5/2-way valves, with solenoid coil

5/2-way valves, without solenoid coil

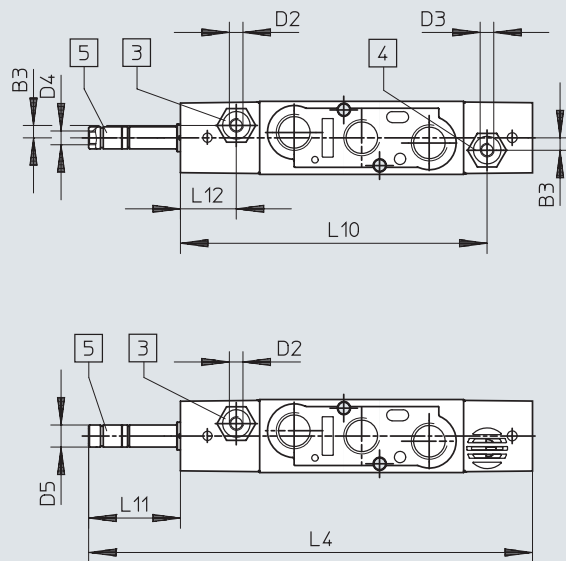
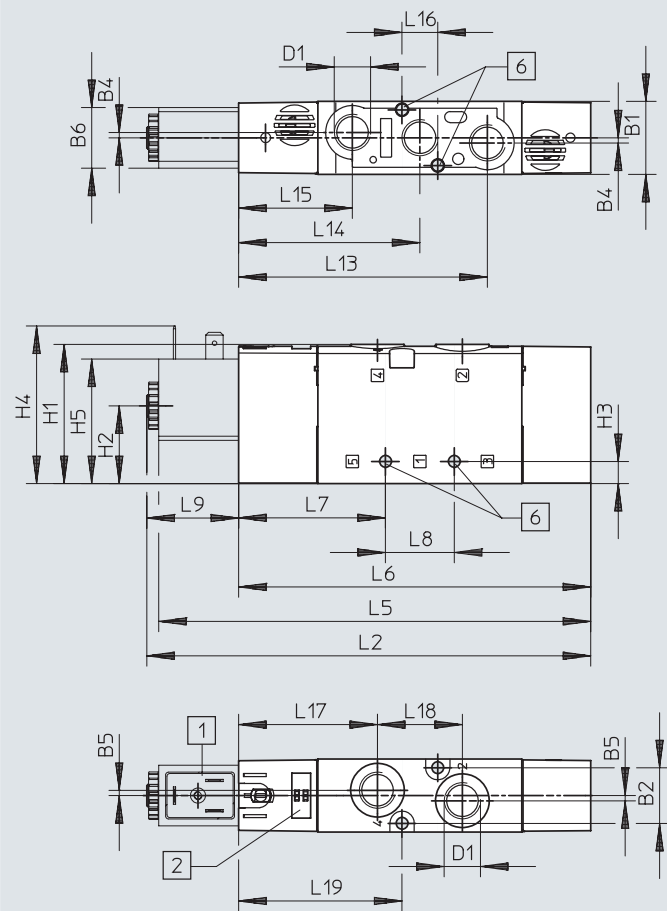

- [1] Solenoid coil interface type B/  
type C
- [2] Space for inscription label
- [3] Port 14 for pilot air supply
- [4] Port 12 for pilot air supply
- [5] Port 84 for pilot exhaust air
- [6] For screw M4



Type	B1	B2	B3	B4	B5	B6	D1	D2	D3	D4
VUVS-L25-M52-...D-N14-...	26.5	20.2	—	1.9	1.9	22	1/4 NPT	—	—	10-32 UNF-2B
VUVS-L25-M52-...ZD-N14-...			4.5					10-32 UNF-2B	10-32 UNF-2B	

Type	D5 ∅	H1	H2	H3	H4	H5	L2	L4	L5	L6	L7	L8	L9
VUVS-L25-M52-...D-N14-...	8	50.5	28.2	8	57.2	45.2	162.2	161.1	156.8	127.8	53.3	25	34.4
VUVS-L25-M52-...ZD-N14-...													

Type	L10	L11	L12	L13	L14	L15	L16	L17	L18	L19
VUVS-L25-M52-...D-N14-...	—	33.3	—	90.3	65.8	41.3	13	50.4	30.8	59.3
VUVS-L25-M52-...ZD-N14-...	111.3		20.3							

Datasheet

Dimensions

Download CAD data → [www.festo.com](http://www.festo.com)

5/3-way valves and 5/2-way double solenoid valves, with solenoid coil

5/3-way valves and 5/2-way double solenoid valves, without solenoid coil

VUVS-L25-P53 . . . . . Z . . . . .  
 VUVS-L25-B52-Z . . . . .

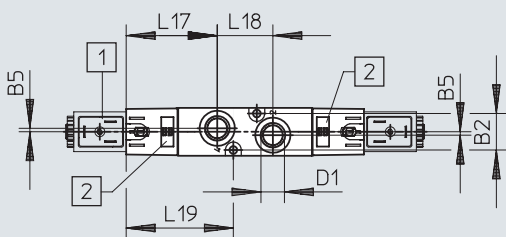
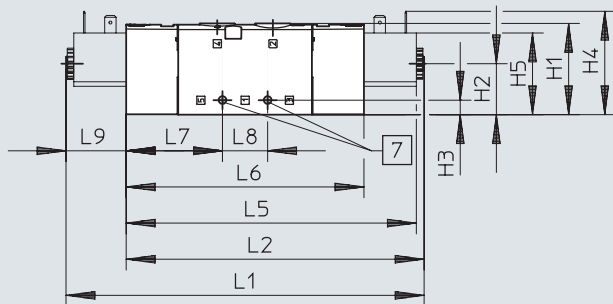
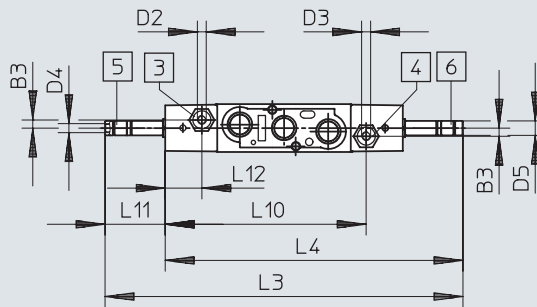
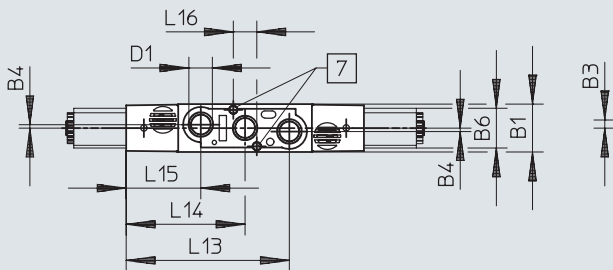

- [1] Solenoid coil interface type B/ type C
- [2] Space for inscription label
- [3] Port 14 for pilot air supply
- [4] Port 12 for pilot air supply
- [5] Port 84 for pilot exhaust air
- [6] Port 82 for pilot exhaust air
- [7] For screw M4

Type	B1	B2	B3	B4	B5	B6	D1	D2	D3	D4
VUVS-L25-P53...D-N14-...	26.5	20.2	-	1.9	1.9	22	1/4 NPT	-	-	10-32 UNF-2B
VUVS-L25-P53...ZD-N14-...			4.5					10-32 UNF-2B	10-32 UNF-2B	
VUVS-L25-B52-D-N14-...			-					-	-	
VUVS-L25-B52-ZD-N14-...			4.5					10-32 UNF-2B	10-32 UNF-2B	

Type	D5 ∅	H1	H2	H3	H4	H5	L1	L2	L3	L4	L5	L6	L7	L8
VUVS-L25-P53...D-N14-...	8	50.5	28.2	8	57.2	45.2	200.3	166	198.2	164.9	160.6	131.6	53.3	25
VUVS-L25-P53...ZD-N14-...														
VUVS-L25-B52-D-N14-...														
VUVS-L25-B52-ZD-N14-...														

Type	L9	L10	L11	L12	L13	L14	L15	L16	L17	L18	L19
VUVS-L25-P53...D-N14-...	34.4	-	33.3	-	90.3	65.8	41.3	13	50.4	30.8	59.3
VUVS-L25-P53...ZD-N14-...		111.3		20.3							
VUVS-L25-B52-D-N14-...		-		-							
VUVS-L25-B52-ZD-N14-...		111.3		20.3							

Datasheet

Dimensions

Foot mounting

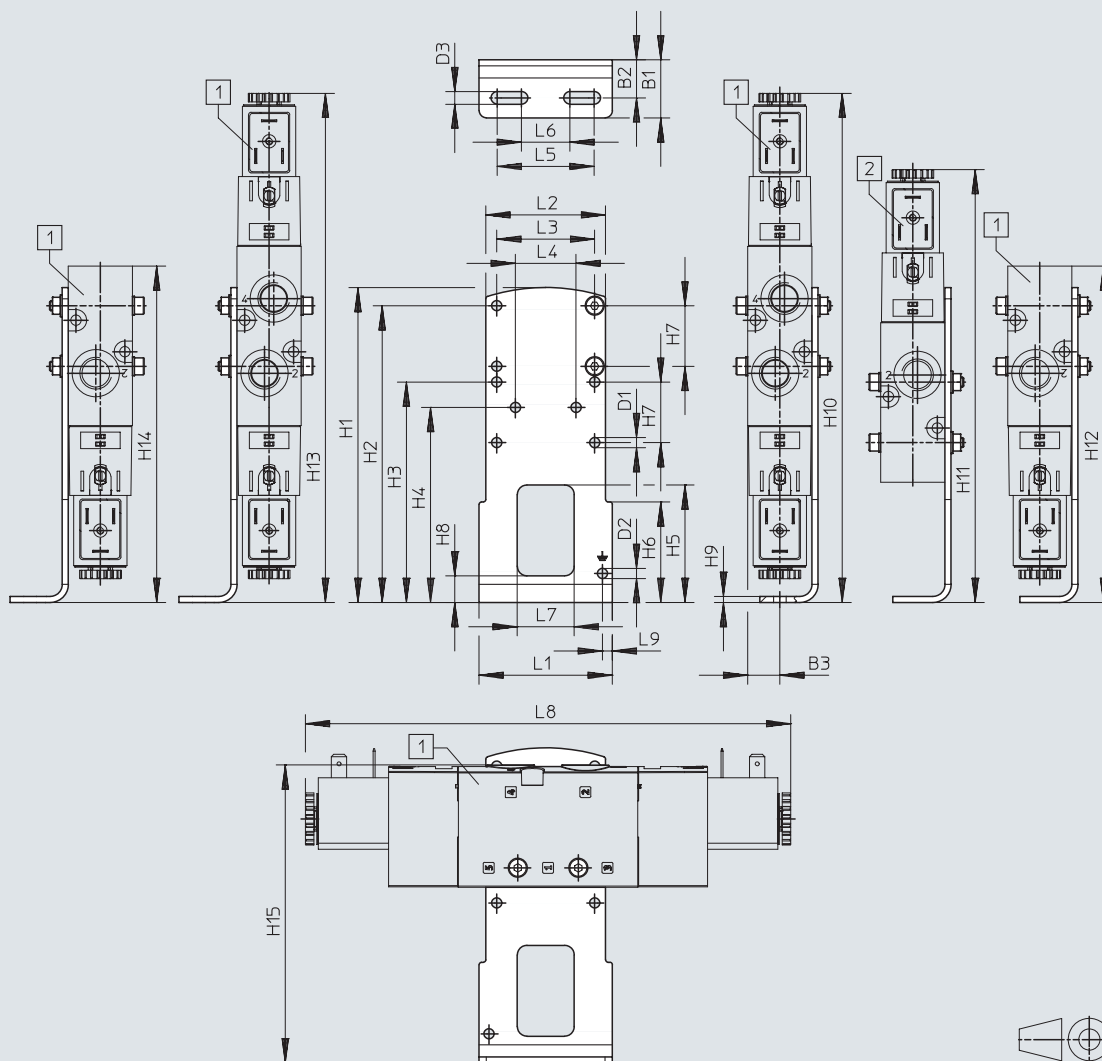

[1] VUVS-L25-B52,  
VUVS-L25-P53,  
VUVS-L25-M52,  
VUVS-L25-M32

[2] VUVS-L25-M52,  
VUVS-L25-M32

Type		B1	B2	B3	D1 ∅	D2 ∅	D3	H1	H2	H3	H4
VAME-B10-25-A	VUVS-L25-B52/P53	24	15.8	13.3	4.2	4.2	5.2	130	122.5	91	80.5
	VUVS-L25-M52										
	VUVS-L25-M32										

Type		H5	H6	H7	H8	H9	H10	H11	H12	H13	H14	
VAME-B10-25-A	VUVS-L25-B52/P53	48.5	41.5	25	11	2.5	210.2	–	210.2	210.2	210.2	
	VUVS-L25-M52							178.7				172
	VUVS-L25-M32											138.9

Type		H15	L1	L2	L3	L4	L5	L6	L7	L8	L9
VAME-B10-25-A	VUVS-L25-B52/P53	123	55	49.4	40.4	25	40	20	23.5	200.3	4.1
	VUVS-L25-M52									162.2	
	VUVS-L25-M32									129	

Datasheet

Dimensions

Wall mounting

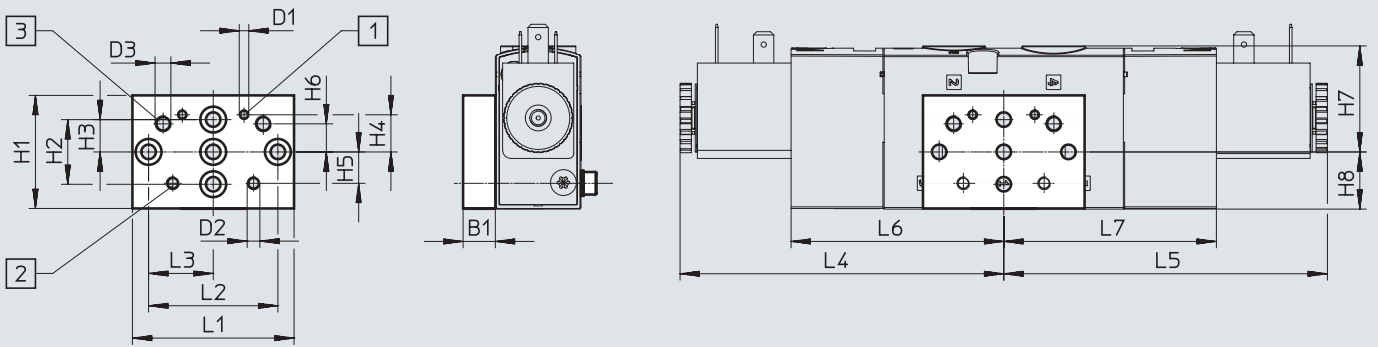

[1] Mounting hole for size 25

[2] Mounting hole for size 20

[3] Mounting hole for size 30

Type		B1	D1	D2	D3	H1	H2	H3	H4	H5	H6
VAME-B10-20-W	VUVS-L25-B52/P53	10	M3	M4	M5	35	20	10	11.5	9.7	8.7
	VUVS-L25-M52										
	VUVS-L25-M32										





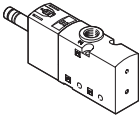
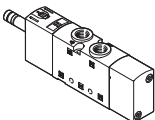
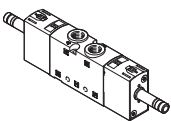
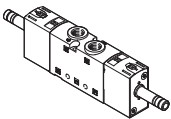

Type		H7	H8	L1	L2	L3	L4	L5	L6	L7
VAME-B10-20-W	VUVS-L25-B52/P53	32.8	17.7	50	40	20	100.2	100.2	65.8	65.8
	VUVS-L25-M52									
	VUVS-L25-M32									



## Accessories

Ordering data		Code	Valve function	Part no.	Type
<b>3/2-way valve without solenoid coil</b>					
	<b>Single solenoid, closed</b>				
	M32C-A	Pneumatic spring return, internal pilot air supply, flow direction not reversible	575544	VUVS-L25-M32C-AD-N14-F8	
	M32C-AZ	Pneumatic spring return, external pilot air supply, reversible flow direction	578182	VUVS-L25-M32C-AZD-N14-F8	
	M32C-M	Mechanical spring return, internal pilot air supply, flow direction not reversible	575545	VUVS-L25-M32C-MD-N14-F8	
			8193001	VUVS-L25-M32C-MD-N14-FN	
	M32C-MZ	Mechanical spring return, external pilot air supply, reversible flow direction	578183	VUVS-L25-M32C-MZD-N14-F8	
	<b>Single solenoid, open</b>				
	M32U-A	Pneumatic spring return, internal pilot air supply, flow direction not reversible	575548	VUVS-L25-M32U-AD-N14-F8	
M32U-M	Mechanical spring return, internal pilot air supply, flow direction not reversible	575549	VUVS-L25-M32U-MD-N14-F8		
		8193002	VUVS-L25-M32U-MD-N14-FN		
<b>5/2-way valve without solenoid coil</b>					
	<b>Single solenoid</b>				
	M52-A	Pneumatic spring return, internal pilot air supply, flow direction not reversible	575552	VUVS-L25-M52-AD-N14-F8	
	M52-AZ	Pneumatic spring return, external pilot air supply, reversible flow direction	578197	VUVS-L25-M52-AZD-N14-F8	
	M52-M	Mechanical spring return, internal pilot air supply, flow direction not reversible	575554	VUVS-L25-M52-MD-N14-F8	
			8192996	VUVS-L25-M52-MD-N14-FN	
M52-MZ	Mechanical spring return, external pilot air supply, reversible flow direction	578198	VUVS-L25-M52-MZD-N14-F8		
	<b>Double solenoid</b>				
	B52	Internal pilot air supply, flow direction not reversible	575556	VUVS-L25-B52-D-N14-F8	
			8192997	VUVS-L25-B52-D-N14-FN	
B52-Z	External pilot air supply, reversible flow direction	578199	VUVS-L25-B52-ZD-N14-F8		
<b>5/3-way valve without solenoid coil</b>					
	<b>Closed</b>				
	P53C-M	Mechanical spring return, internal pilot air supply, flow direction not reversible	575558	VUVS-L25-P53C-MD-N14-F8	
			8192998	VUVS-L25-P53C-MD-N14-FN	
	P53C-MZ	Mechanical spring return, external pilot air supply, reversible flow direction	578206	VUVS-L25-P53C-MZD-N14-F8	
	<b>Exhausted</b>				
	P53E	Mechanical spring return, internal pilot air supply, flow direction not reversible	575562	VUVS-L25-P53E-MD-N14-F8	
			8192999	VUVS-L25-P53E-MD-N14-FN	
	<b>Pressurised</b>				
	P53U	Mechanical spring return, internal pilot air supply, flow direction not reversible	575560	VUVS-L25-P53U-MD-N14-F8	
8193000			VUVS-L25-P53U-MD-N14-FN		





## Accessories



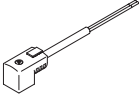

Ordering data		Description	Part no.	Type
<b>Solenoid coils for valves with armature tube 8 mm</b>				
	Plug pattern type C, to DIN EN 175301-803	12 V DC	8030810	VACF-B-C1-5
		24 V DC	8030811	VACF-B-C1-1
		48 V DC	8030812	VACF-B-C1-7
		24 V AC/50-60 Hz	8030813	VACF-B-C1-1A
		48 V AC/50-60 Hz	8030814	VACF-B-C1-7A
		110/120 V AC/50-60 Hz	8030815	VACF-B-C1-16B
		230/240 V AC/50-60 Hz	8030817	VACF-B-C1-3W
	Plug pattern type C, industry standard	24 V DC	8153947	VACF-B-E1-1
	Plug pattern type B, industry standard	12 V DC	8030801	VACF-B-B2-5
		24 V DC	8030802	VACF-B-B2-1
		48 V DC	8030803	VACF-B-B2-7
		24 V AC/50-60 Hz	8030804	VACF-B-B2-1A
		48 V AC/50-60 Hz	8030805	VACF-B-B2-7A
		110/120 V AC/50-60 Hz	8030806	VACF-B-B2-16B
		230/240 V AC/50-60 Hz	8030808	VACF-B-B2-3W
	Single plug M8, 4-pin	24 V DC	8150875	VACF-B-R1-1L
	Single plug M12, A-coded, to EN 61076-2-101	24 V DC	8150876	VACF-B-R3-1L
	Single plug M12, A-coded, pin assignment to DESINA	24 V DC	8150877	VACF-B-R4-1L
	Single plug M8, 3-pin	24 V DC	8150878	VACF-B-R8-1RAL
	Single plug M8, 4-pin	24 V DC	8150879	VACF-B-R1-1RAL
	Single plug M12, A-coded, to EN 61076-2-101	24 V DC	8150873	VACF-B-R3-1RAL
	Single plug M12, A-coded, pin assignment to DESINA	24 V DC	8150880	VACF-B-R4-1RAL
<b>Seal set for solenoid coil</b>				
	Plug pattern type C to guarantee degree of protection IP67		2643771	VAMC-B10-C-B-S8
	Plug pattern type B to guarantee degree of protection IP67		8034609	VAMC-B10-B-B-S8
<b>Cover cap</b>				
	For manual override, non-detenting or covered		8028240	VAMC-B10-20-CH2

Ordering data		Description	Part no.	Type		
<b>Plug socket</b>						
	<b>Plug pattern type C, to EN 175301-803</b>					
	3-pin, screw terminal	Cable connector M12	0 ... 250 V AC/DC	IP65	539712	MSSD-EB-M12
		Cable connector Pg7			151687	MSSD-EB
	3-pin, angled socket	Cable connector M12	0 ... 24 V DC	IP65	570367	MSSD-EB-M12-24VDC-SD-EX
	<b>Plug pattern type B, industry standard</b>					
	3-pin, screw terminal	Cable connector M16	0 ... 250 V AC/DC	IP65	539710	MSSD-F-M16
		Cable fitting Pg9			34431	MSSD-F
	<b>Plug pattern type A, to EN 175301-803</b>					
	3-pin, screw terminal	Cable connector M16	0 ... 250 V AC/DC	IP65	8037151	MSSD-C-EX
	3-pin, screw terminal	Cable connector M16	0 ... 250 V AC/DC	IP65	539709	MSSD-C-M16
<b>Adapter</b>						
	Socket type C, to EN 175301-803	Plug M12x1, 2-pin, A-coded	12 ... 24 V AC/DC	IP65	188024	MSSD-EB-M12-MONO

## Accessories

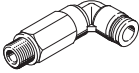
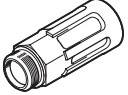

Ordering data		Description	Part no.	Type		
<b>Plug socket with cable</b>						
	<b>Plug pattern type C, to EN 175301-803</b>					
	Angled socket, 3-pin Cable, open end, 3-core	24 V DC	LED	2.5 m	151688	KMEB-1-24-2.5-LED
				5 m	151689	KMEB-1-24-5-LED
				10 m	193457	KMEB-1-24-10-LED
	230 V AC <sup>1)</sup>	–	2.5 m	151690	KMEB-1-230AC-2.5	
			5 m	151691	KMEB-1-230AC-5	
	<b>Plug pattern type B, industry standard</b>					
	Angled socket, 3-pin Cable, open end, 3-core	24 V DC	LED	2.5 m	30935	KMF-1-24DC-2.5-LED
				5 m	30937	KMF-1-24DC-5-LED
				10 m	193458	KMF-1-24-10-LED
230 V AC <sup>1)</sup>		–	2.5 m	30936	KMF-1-230AC-2.5	
			5 m	30938	KMF-1-230AC-5	
<b>Illuminating seal</b>						
	Plug pattern type C, to DIN EN 175301-803	24 V DC	151717	MEB-LD-12-24DC		
		230 V AC	151718	MEB-LD-230AC		
	Plug pattern type B, industry standard	24 V DC	19143	MF-LD-12-24DC		
		230 V AC	19144	MF-LD-230AC		

1) Plug socket 230 V AC can be used for 24 V DC without LED configuration.

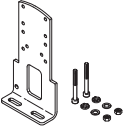
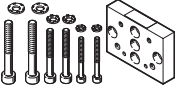
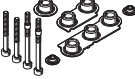
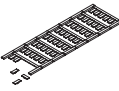

Ordering data		Description	Part no.	Type	PU <sup>1)</sup>	
<b>Push-in fitting with internal hex</b>						
	Connecting thread 10-32 UNF for tubing O.D.	5/32 "	572312	QBM-10-32-UNF-5/32-I-U	10	
		Connecting thread 1/4 NPT for tubing O.D.	1/4 "	572320	QB-1/4-1/4-I-U	10
			5/16 "	572321	QB-1/4-5/16-I-U	10
			3/8 "	572322	QB-1/4-3/8-I-U	10
<b>Angled push-in fitting, with external hex</b>						
	Connecting thread 1/4 NPT for tubing O.D.	1/4 "	533295	QBL-1/4-1/4-U	10	
		5/16 "	533296	QBL-1/4-5/16-U	10	
		3/8 "	533297	QBL-1/4-3/8-U	5	
<b>Angled push-in fitting, long, with external hex</b>						
	Connecting thread 1/4 NPT for tubing O.D.	1/4 "	564674	QBL-1/4-1/4-U	10	
		5/16 "	564675	QBL-1/4-5/16-U	10	
		3/8 "	564676	QBL-1/4-3/8-U	5	
<b>Silencer</b>						
	With connecting thread NPT, metal design	1/4 NPT	12639	U-1/4-B-NPT	1	
	With connecting thread NPT, sintered design, long	1/4 NPT	1206990	AMTE-M-LH-N14	20	

1) Packaging unit

## Accessories

Ordering data			Weight	Part no.	Type
Description			[g]		
<b>Foot mounting</b>					
	With screw set for attaching the valve to the foot mounting		130	2293485	VAME-B10-25-A
<b>Wall mounting</b>					
	With screw set for attaching the valve to the wall mounting (for size 20, 25, 30)		53	576413	VAME-B10-20-W
<b>Assortment of spare parts</b>					
	Set comprising seals and screws		12	8035636	VAME-B10-25-MK
<b>Inscription label</b>					
	Frame with 40 labels		–	565306	ASLR-C-E4
<b>Mounting kit</b>					
	With mounting bracket for lateral valve mounting	For standards-based cylinder DSBC-50...125	160	2612128	DAVM-MW-V1-50-V

## Datasheet

-  Flow rate  
up to 2300 l/min (±20%)
-  Valve width  
31 mm
-  Voltage  
12, 24 V DC  
24, 110, 120, 230, 240 V AC

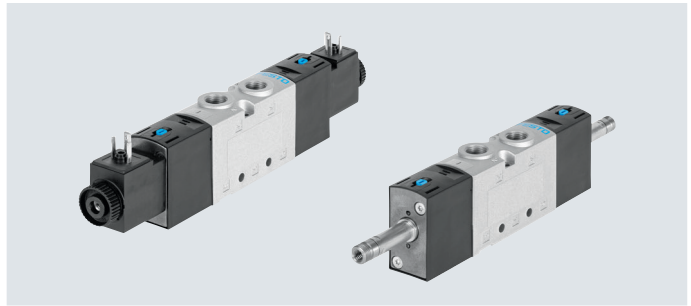

General technical data							
Valve function	3/2		5/2		5/3		
Order code for valves	M32C	M32U	M52	B52	P53C	P53U	P53E
Valve width [mm]	31						
Nominal width [mm]	9.4				8.9	8.1	
Design	Piston spool						
Flow direction	Reversible with external pilot air supply						
Pilot air supply	Internal or external						
Type of control	Piloted						
Manual override	Non-detenting, detenting						
Overlap	Positive overlap						
Sealing principle	Soft						
Type of mounting	Optionally via through-hole or on manifold rail						
Standard nominal flow rate qnN [l/min]	2300	2300	2300		2000	1600	1600
Actuation type	Electrical						
Mounting position	Any						
Exhaust air function	Can be throttled						
Pneumatic port	1, 2, 3	3/8 NPT	3/8 NPT	3/8 NPT	3/8 NPT	3/8 NPT	3/8 NPT
	4, 5	–	–	3/8 NPT	3/8 NPT	3/8 NPT	3/8 NPT
Pilot exhaust air port 82/84	10-32 UNF-2B						

ATEX	
Type	VUVS-L...-EX2
ATEX category for gas	II 3G
Type of (ignition) protection for gas	Ex ec IICT4 Gc X
ATEX category for dust	II 3D
Type of ignition protection for dust	Ex tc IIIC T115°C Dc X
Explosion-proof ambient temperature [°C]	10 °C ≤ Ta ≤ +60 °C
CE marking (see declaration of conformity) <sup>1)</sup>	To EU Explosion Protection Directive (ATEX)
UKCA marking (see declaration of conformity) <sup>1)</sup>	To UK explosion regulations
Explosion protection certification outside the EU	EPL Dc (GB)
	EPL Gc (GB)

1) For information about the area of use, see the declaration of conformity at: [www.festo.com/catalogue/...](http://www.festo.com/catalogue/...) → Support/Downloads.

If the devices are subject to usage restrictions in residential, commercial or light-industrial environments, further measures for the reduction of the emitted interference may be necessary.

## Datasheet

Technical data – 3/2-way valves					
Order code for valves		M32C		M32U	
Normal position		Closed		Open	
Stable position		Monostable		Monostable	
Reset method		Pneumatic spring	Mechanical spring	Pneumatic spring	Mechanical spring
Switching times in [ms]	On	19	16	19	15
	Off	36	58	37	57
	Change-over	–	–	–	–
Product weight without solenoid coil	[g]	354	354	354	354
Product weight with solenoid coil	[g]	405	405	405	405

Technical data – 5/2-way valves				
Order code for valves		M52		B52
Normal position		–		–
Stable position		Monostable		Bistable
Reset method		Pneumatic spring	Mechanical spring	–
Switching times in [ms]	On	24	17	–
	Off	49	62	–
	Change-over	–	–	13
Product weight without solenoid coil	[g]	450	450	464
Product weight with solenoid coil	[g]	500	500	565

Technical data – 5/3-way valves					
Order code for valves		P53C		P53U	P53E
Normal position/mid-position		Closed		Pressurised	Exhausted
Stable position		Monostable			
Reset method		Mechanical spring			
Switching times in [ms]	On	17	18	20	
	Off	76	75	74	
	Change-over	39	31	36	
Product weight without solenoid coil	[g]	461	461	461	
Product weight with solenoid coil	[g]	562	562	562	

Safety characteristics		
Max. positive test pulse with logic 0	[µs]	2000 (valves with VACF-B-...-1)
Max. negative test pulse with logic 1	[µs]	3600 (valves with VACF-B-...-1)
Shock resistance		Shock test with severity level 2 to FN 942017-5 and EN 60068-2-27
Vibration resistant		Transport application test with severity level 2 to FN 942017-4 and EN 60068-2-6

## Datasheet

Operating and environmental conditions		M32	M52	B52	P53
Order code for valves					
Operating medium		Compressed air to ISO 8573-1:2010 [7:4:4]			
Pilot medium		Compressed air to ISO 8573-1:2010 [7:4:4]			
Note on the operating/pilot medium		Lubricated operation possible (in which case lubricated operation will always be required)			
Cleanroom class		ISO class 6			
Operating pressure	[MPa]	0.25 ... 1		0.15 ... 1	0.25 ... 1
	[bar]	2.5 ... 10		1.5 ... 10	2.5 ... 10
Pilot pressure	[MPa]	0.25 ... 1		0.15 ... 1	0.25 ... 1
	[bar]	2.5 ... 10		1.5 ... 10	2.5 ... 10
Ambient temperature	[°C]	-10 ... +60			
Temperature of medium	[°C]	-10 ... +60			
Certification		c UL us - Recognized (OL)			
Maritime classification <sup>1)</sup>		See certificate (for VUVS-...-F8 and VUVS-...-F8-...-B2 only)			
Corrosion resistance class CRC <sup>2)</sup>		2			

1) More information [www.festo.com/catalogue/...](http://www.festo.com/catalogue/...) → Support/Downloads.

2) More information [www.festo.com/x/topic/crc](http://www.festo.com/x/topic/crc)

Electrical data	
Electrical connection	Via solenoid coil
Operating voltage [V DC]	→ Internet: vacf
Permitted voltage fluctuations [%]	
Power [W]	
Duty cycle [%]	
Degree of protection to EN 60529	

Materials	
Housing	Die-cast aluminium
Seals	HNBR, NBR
Piston spool	Wrought aluminium alloy
Screws	Nickel-plated steel
Note on materials	RoHS-compliant

Datasheet

Dimensions

Download CAD data → [www.festo.com](http://www.festo.com)

3/2-way valves, with solenoid coil

3/2-way valves, without solenoid coil

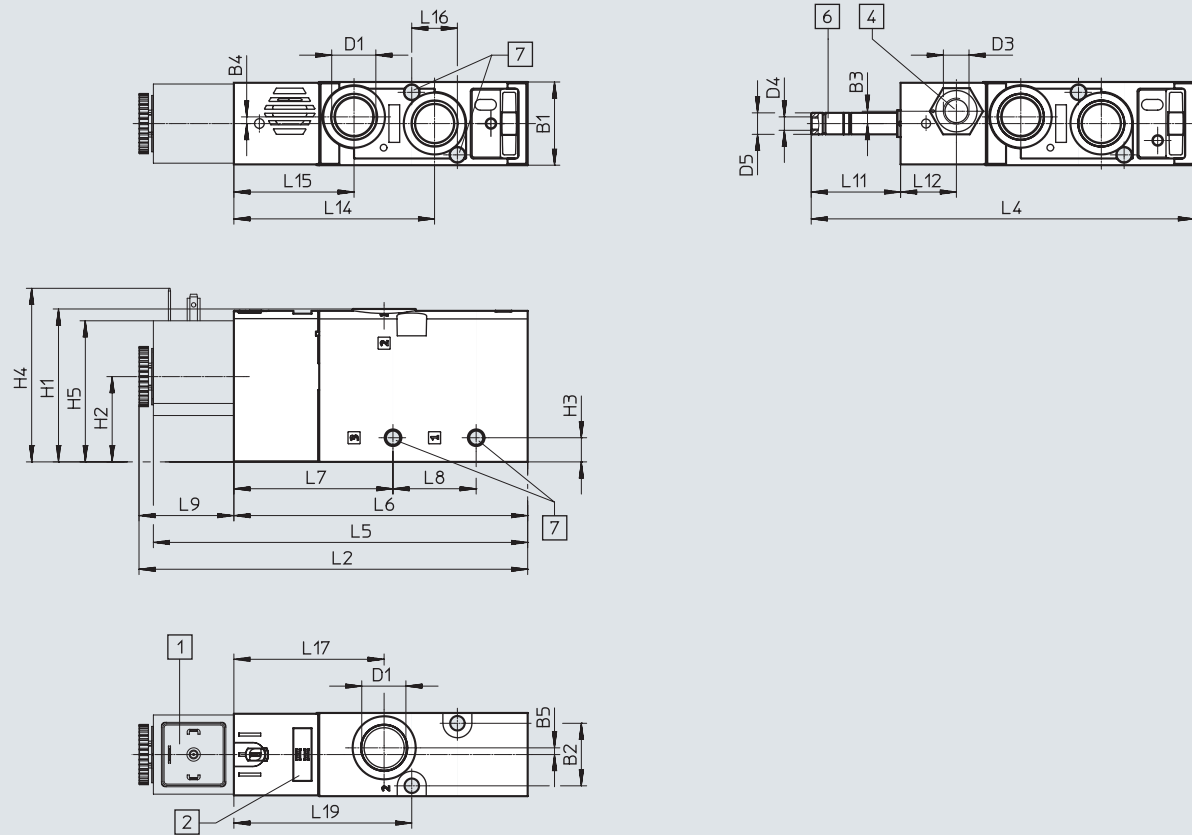

- [1] Solenoid coil interface type B/  
type C
- [2] Space for inscription label
- [4] Port 10/12 for pilot air supply
- [6] Port 82 for pilot exhaust air
- [7] For screw M5

Type	B1	B2	B3	B4	B5	D1	D3	D4	D5 ∅	H1	H2	H3	H4	H5
VUVS-L30-M32....D-N38-...	31	23.3	–	2.5	2.5	3/8 NPT	–	10-32 UNF-2B	8	57	31.8	9	63.7	51.6

Type	L2	L4	L5	L6	L7	L8	L9	L11	L12	L14	L15	L16	L17	L19
VUVS-L30-M32....D-N38-...	144.9	142.8	139.5	109.5	59.3	31	35.4	33.3	–	74.8	44.8	17	56	66.3

Datasheet

Dimensions

Download CAD data → [www.festo.com](http://www.festo.com)

5/2-way valves, with solenoid coil

5/2-way valves, without solenoid coil

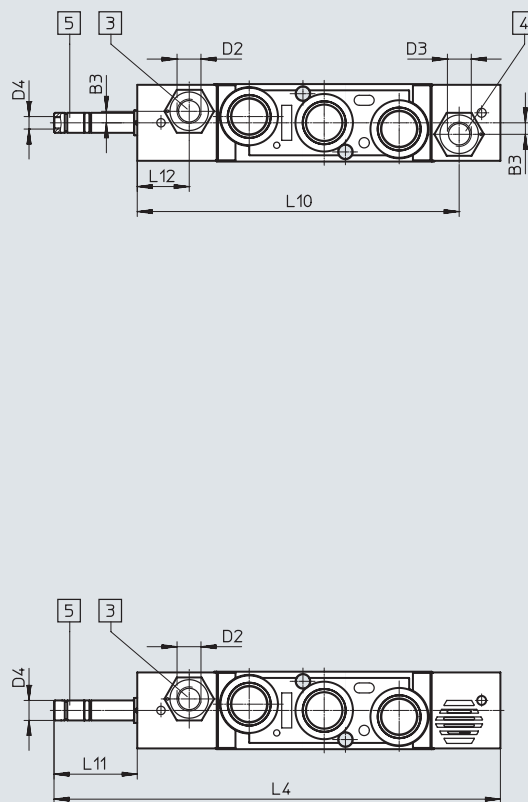
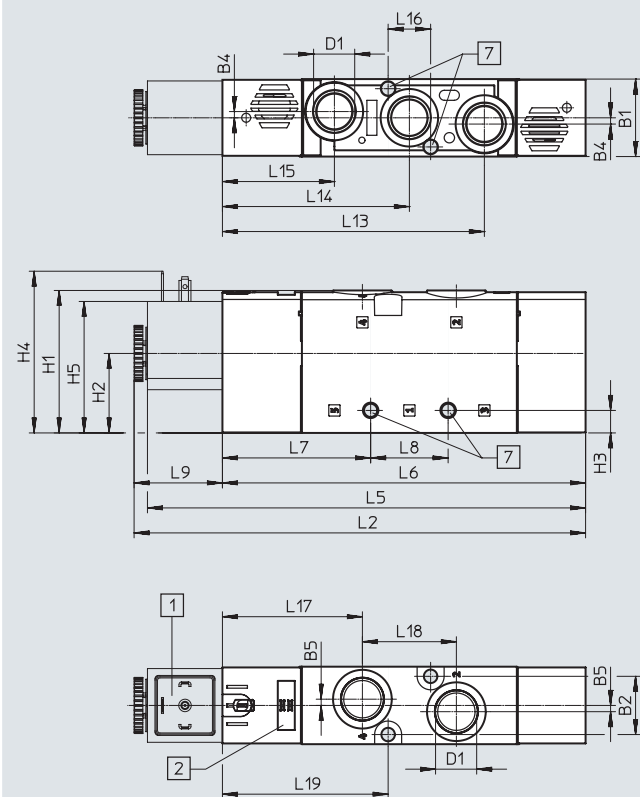

- [1] Solenoid coil interface type B/ type C
- [2] Space for inscription label
- [3] Port 14 for pilot air supply
- [4] Port 12 for pilot air supply
- [5] Port 84 for pilot exhaust air
- [7] For screw M5

Type	B1	B2	B3	B4	B5	D1	D2	D3	D4	D5 Ø	H1	H2	H3	H4	H5
VUVS-L30-M52-...D-N38-...	31	23.3	-	2.5	2.5	3/8 NPT	-	-	10-32 UNF-2B	8	57	31.8	9	63.7	51.6

Type	L2	L4	L5	L6	L7	L8	L9	L10	L11	L12	L13	L14	L15	L16	L17	L18	L19
VUVS-L30-M52-...D-N38-...	180.7	178.6	179.6	145.3	59.3	31	35.4	-	33.3	-	104.8	74.8	44.8	17	56	37.6	66.3



Datasheet

Dimensions

Download CAD data → [www.festo.com](http://www.festo.com)

5/3-way valves and 5/2-way double solenoid valves, with solenoid coil

5/3-way valves and 5/2-way double solenoid valves, without solenoid coil

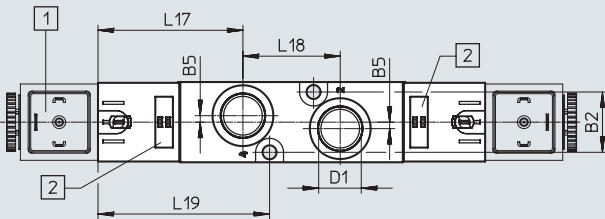
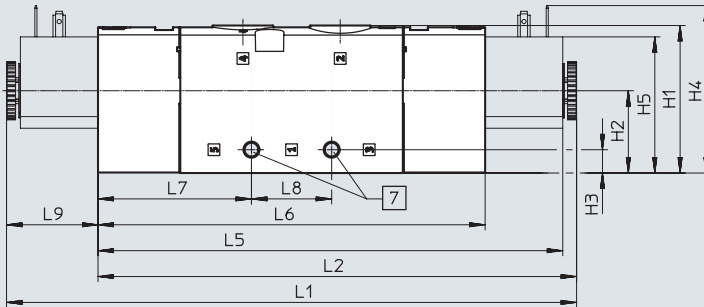
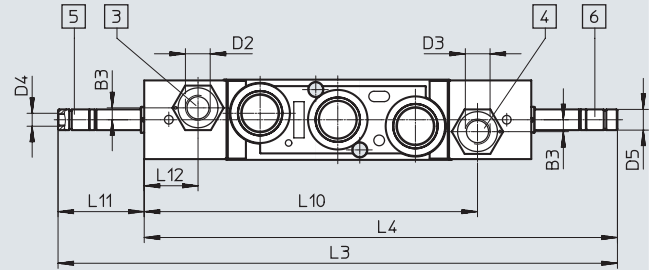
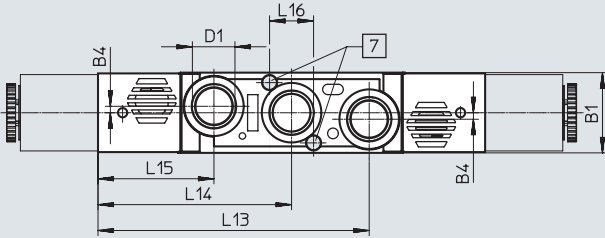

- [1] Solenoid coil interface type B/ type C
- [2] Space for inscription label

- [3] Port 14 for pilot air supply
- [4] Port 12 for pilot air supply

- [5] Port 84 for pilot exhaust air
- [6] Port 82 for pilot exhaust air

- [7] For screw M5

Type	B1	B2	B4	B5	D1	D4	D5 ∅	H1	H2	H3	H4	H5
VUVS-L30-P53...-MD-N38-F8	31	23.3	2.5	2.5	3/8 NPT	10-32 UNF-2B	8	57	31.8	9	63.7	51.6
VUVS-L30-B52-D-N38-F8												

Type	L1	L2	L3	L4	L5	L6	L7	L8	L9	L11
VUVS-L30-P53...-MD-N38-F8	220.3	185	216.2	182.9	179.6	149.6	59.3	31	35.4	33.3
VUVS-L30-B52-D-N38-F8										

Type	L13	L14	L15	L16	L17	L18	L19
VUVS-L30-P53...-MD-N38-F8	104.8	74.8	44.8	17	56	37.6	66.3
VUVS-L30-B52-D-N38-F8							

Datasheet

Dimensions

Foot mounting

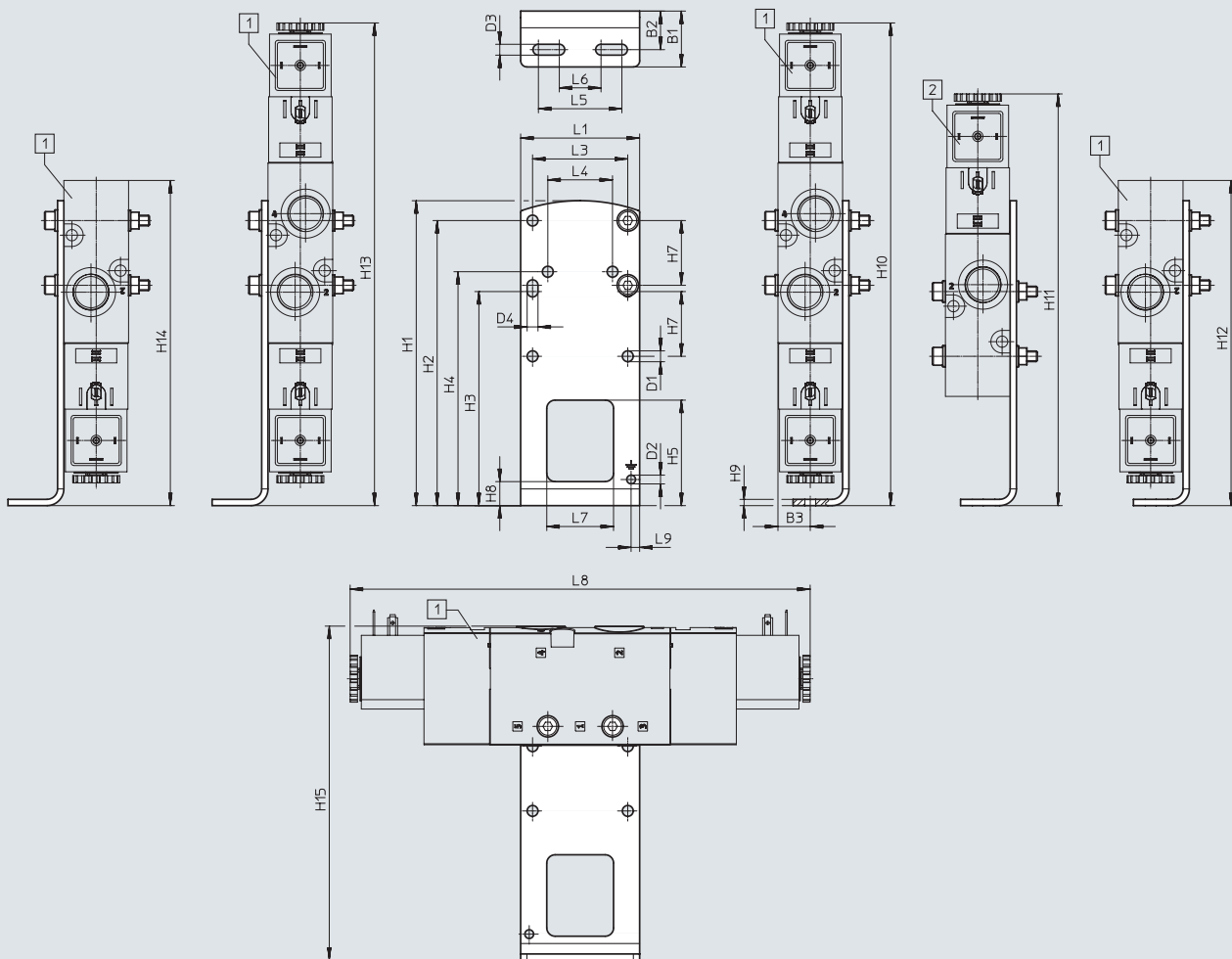

[1] VUVS-L30-B52,  
VUVS-L30-P53,  
VUVS-L30-M52,  
VUVS-L30-M32

[2] VUVS-L30-M52,  
VUVS-L30-M32

Type		B1	B2	B3	D1 ∅	D2 ∅	D3	D4	H1	H2	H3
VAME-B10-30-A	VUVS-L30-B52/P53	26.8	18.5	15.5	5.2	4.2	5.2	5.2	146	136.5	102.5
	VUVS-L30-M52										
	VUVS-L30-M32										

Type		H4	H5	H7	H8	H9	H10	H11	H12	H13	H14
VAME-B10-30-A	VUVS-L30-B52/P53	112	50.5	31	11.5	3	231.2	-	231.2	231.2	231.2
	VUVS-L30-M52								197.2		191.5
	VUVS-L30-M32								155.7		155.7

Type		H15	L1	L3	L4	L5	L6	L7	L8	L9
VAME-B10-30-A	VUVS-L30-B52/P53	160	57	45.6	31	40	20	32	220.3	4.1
	VUVS-L30-M52								180.7	
	VUVS-L30-M32								144.9	

Datasheet

Dimensions

Wall mounting

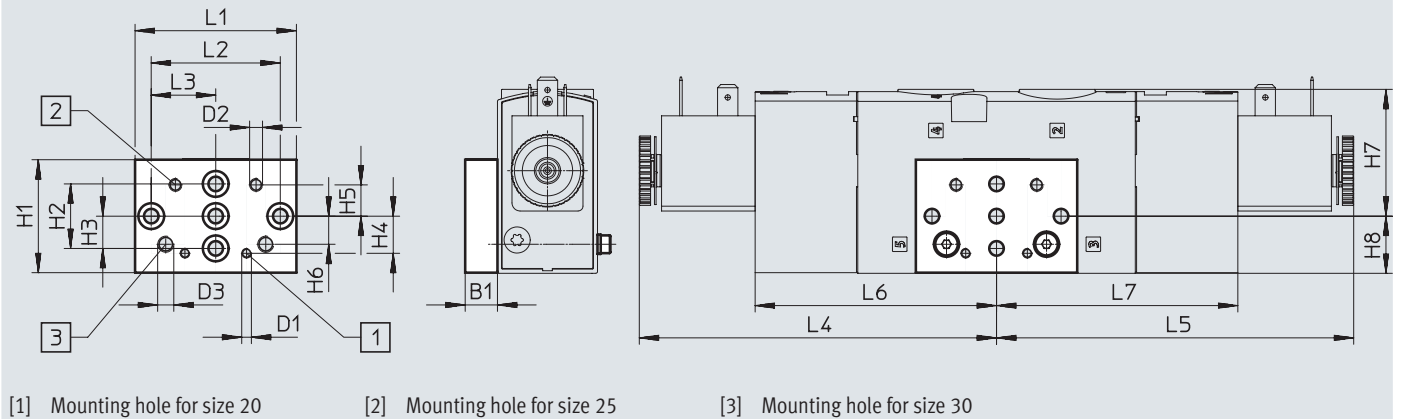





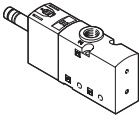
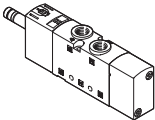
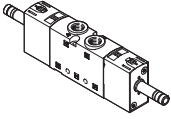
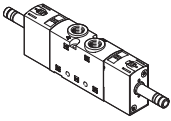

Type		B1	D1	D2	D3	H1	H2	H3	H4	H5	H6
VAME-B10-20-W	VUVS-L30-B52/P53	10	M3	M4	M5	35	20	10	11.5	9.7	8.7
	VUVS-L30-M52										
	VUVS-L30-M32										

Type		H7	H8	L1	L2	L3	L4	L5	L6	L7
VAME-B10-20-W	VUVS-L30-B52/P53	39.3	17.7	50	40	20	110.2	110.2	74.8	74.8
	VUVS-L30-M52							70.5		-
	VUVS-L30-M32							34.7		-





## Accessories

Ordering data		Code	Valve function	Part no.	Type
<b>3/2-way valve without solenoid coil</b>					
	<b>Single solenoid, closed</b>				
	M32C-A	Pneumatic spring return, internal pilot air supply, flow direction not reversible	575637	VUVS-L30-M32C-AD-N38-F8	
	M32C-M	Mechanical spring return, internal pilot air supply, flow direction not reversible	575638	VUVS-L30-M32C-MD-N38-F8	
	<b>Single solenoid, open</b>				
M32U-A	Pneumatic spring return, internal pilot air supply, flow direction not reversible	575641	VUVS-L30-M32U-AD-N38-F8		
M32U-M	Mechanical spring return, internal pilot air supply, flow direction not reversible	575642	VUVS-L30-M32U-MD-N38-F8		
<b>5/2-way valve without solenoid coil</b>					
	<b>Single solenoid</b>				
	M52-A	Pneumatic spring return, internal pilot air supply, flow direction not reversible	575645	VUVS-L30-M52-AD-N38-F8	
M52-M	Mechanical spring return, internal pilot air supply, flow direction not reversible	575647	VUVS-L30-M52-MD-N38-F8		
	<b>Double solenoid</b>				
	B52	Internal pilot air supply, flow direction not reversible	575649	VUVS-L30-B52-D-N38-F8	
<b>5/3-way valve without solenoid coil</b>					
	<b>Closed</b>				
	P53C	Mechanical spring return, internal pilot air supply, flow direction not reversible	575651	VUVS-L30-P53C-MD-N38-F8	
	<b>Exhausted</b>				
	P53E	Mechanical spring return, internal pilot air supply, flow direction not reversible	575655	VUVS-L30-P53E-MD-N38-F8	
<b>Pressurised</b>					
P53U	Mechanical spring return, internal pilot air supply, flow direction not reversible	575653	VUVS-L30-P53U-MD-N38-F8		

## Accessories



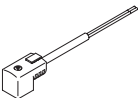

Ordering data		Description	Part no.	Type		
<b>Solenoid coils for valves</b>						
	Plug pattern type C, to DIN EN 175301-803	12 V DC	8030810	VACF-B-C1-5		
		24 V DC	8030811	VACF-B-C1-1		
		48 V DC	8030812	VACF-B-C1-7		
		24 V AC/50-60 Hz	8030813	VACF-B-C1-1A		
		48 V AC/50-60 Hz	8030814	VACF-B-C1-7A		
		110/120 V AC/50-60 Hz	8030815	VACF-B-C1-16B		
		230/240 V AC/50-60 Hz	8030817	VACF-B-C1-3W		
	Plug pattern type C, industry standard	24 V DC	8153947	VACF-B-E1-1		
	Plug pattern type B, industry standard	12 V DC	8030801	VACF-B-B2-5		
		24 V DC	8030802	VACF-B-B2-1		
		48 V DC	8030803	VACF-B-B2-7		
		24 V AC/50-60 Hz	8030804	VACF-B-B2-1A		
		48 V AC/50-60 Hz	8030805	VACF-B-B2-7A		
		110/120 V AC/50-60 Hz	8030806	VACF-B-B2-16B		
		230/240 V AC/50-60 Hz	8030808	VACF-B-B2-3W		
	Plug pattern type A, to EN 175301-803	12 V DC	8030821	VACF-A-A1-5		
		24 V DC	8030822	VACF-A-A1-1		
		48 V DC	8030823	VACF-A-A1-7		
		24 V AC/50-60 Hz	8030824	VACF-A-A1-1A		
		48 V AC/50-60 Hz	8030825	VACF-A-A1-7A		
		110/120 V AC/50-60 Hz	8030826	VACF-A-A1-16B		
		230/240 V AC/50-60 Hz	8030828	VACF-A-A1-3W		
Single plug M8, 4-pin	24 V DC	8150875	VACF-B-R1-1L			
Single plug M12, A-coded, to EN 61076-2-101	24 V DC	8150876	VACF-B-R3-1L			
Single plug M12, A-coded, pin assignment to DESINA	24 V DC	8150877	VACF-B-R4-1L			
Single plug M8, 3-pin	24 V DC	8150874	VACF-B-R8-1L			
	Single plug M8, 3-pin	24 V DC	8150878	VACF-B-R8-1RAL		
	Single plug M8, 4-pin	24 V DC	8150879	VACF-B-R1-1RAL		
	Single plug M12, A-coded, to EN 61076-2-101	24 V DC	8150873	VACF-B-R3-1RAL		
	Single plug M12, A-coded, pin assignment to DESINA	24 V DC	8150880	VACF-B-R4-1RAL		
	<b>Seal set for solenoid coil</b>					
	Plug pattern type B to guarantee degree of protection IP67		8034609	VAMC-B10-B-B-S8		
	Plug pattern type A to guarantee degree of protection IP67		8034611	VAMC-B10-A-B-S8		
<b>Cover cap</b>						
	For manual override, non-detenting or covered		8028240	VAMC-B10-20-CH2		
<b>Plug socket</b>						
	<b>Plug pattern type C, to DIN EN 175301-803</b>					
	3-pin, screw terminal	Cable connector M12	0 ... 250 V AC/DC	IP65	539712	MSSD-EB-M12
		Cable connector Pg7			★ 151687	MSSD-EB
	3-pin, angled socket	Cable connector M12	0 ... 24 V DC	IP65	570367	MSSD-EB-M12-24VDC-SD-EX
	<b>Plug pattern type B, industry standard</b>					
	3-pin, screw terminal	Cable connector M16	0 ... 250 V AC/DC	IP65	539710	MSSD-F-M16
Cable fitting Pg9		★ 34431			MSSD-F	

## Accessories



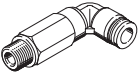
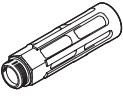

Ordering data		Description	Part no.	Type	
<b>Plug socket</b>					
	<b>Plug pattern type A, to EN 175301-803</b>				
	3-pin, angled socket	Cable fitting Pg9	0 ... 250 V AC/DC	IP65	<b>34583</b> <b>MSSD-C</b>
	3-pin, angled socket	Cable connector M16	0 ... 250 V AC/DC	IP65	<b>539709</b> <b>MSSD-C-M16</b>
<b>Adapter</b>					
	Socket type C, to EN 175301-803	Plug M12x1, 2-pin, A-coded	12 ... 24 V AC/DC	IP65	<b>188024</b> <b>MSSD-EB-M12-MONO</b>
<b>Plug socket with cable</b>					
	<b>Plug pattern type C, to EN 175301-803</b>				
	Angled socket, 3-pin Cable, open end, 3-core	24 V DC	LED	2.5 m	<b>151688</b> <b>KMEB-1-24-2.5-LED</b>
				5 m	<b>151689</b> <b>KMEB-1-24-5-LED</b>
				10 m	<b>193457</b> <b>KMEB-1-24-10-LED</b>
		230 V AC <sup>1)</sup>	–	2.5 m	<b>151690</b> <b>KMEB-1-230AC-2.5</b>
				5 m	<b>151691</b> <b>KMEB-1-230AC-5</b>
	<b>Plug pattern type B, industry standard</b>				
	Angled socket, 3-pin Cable, open end, 3-core	24 V DC	LED	2.5 m	<b>30935</b> <b>KMF-1-24DC-2.5-LED</b>
				5 m	<b>30937</b> <b>KMF-1-24DC-5-LED</b>
				10 m	<b>193458</b> <b>KMF-1-24-10-LED</b>
		230 V AC <sup>1)</sup>	–	2.5 m	<b>30936</b> <b>KMF-1-230AC-2.5</b>
				5 m	<b>30938</b> <b>KMF-1-230AC-5</b>
	<b>Plug pattern type A, to EN 175301-803</b>				
	Angled socket, 3-pin Cable, open end, 3-core	24 V DC	LED	2.5 m	<b>30931</b> <b>KMC-1-24DC-2.5-LED</b>
5 m				<b>30933</b> <b>KMC-1-24DC-5-LED</b>	
10 m				<b>193459</b> <b>KMC-1-24-10-LED</b>	
	230 V AC <sup>1)</sup>	–	2.5 m	<b>30932</b> <b>KMC-1-230AC-2.5</b>	
			5 m	<b>30934</b> <b>KMC-1-230AC-5</b>	
<b>Illuminating seal</b>					
	Plug pattern type C, to DIN EN 175301-803	24 V DC	<b>151717</b>	<b>MEB-LD-12-24DC</b>	
		230 V AC	<b>151718</b>	<b>MEB-LD-230AC</b>	
	Plug pattern type B, industry standard	24 V DC	<b>19143</b>	<b>MF-LD-12-24DC</b>	
		230 V AC	<b>19144</b>	<b>MF-LD-230AC</b>	

1) Plug socket 230 V AC can be used for 24 V DC without LED configuration.

## Accessories

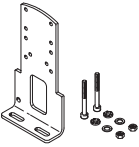
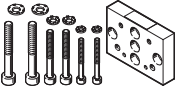
Ordering data		Description	Part no.	Type	PU <sup>1)</sup>
<b>Push-in fitting with internal hex</b>					
	Connecting thread 10-32 UNF for tubing O.D.	5/32 "	572312	QBM-10-32-UNF-5/32-I-U	10
	Connecting thread 3/8 NPT for tubing O.D.	5/16 "	572323	QB-3/8-5/16-I-U	10
		3/8 "	572324	QB-3/8-3/8-I-U	10
		1/2 "	572325	QB-3/8-1/2-I-U	10
<b>Angled push-in fitting, with external hex</b>					
	Connecting thread 3/8 NPT for tubing O.D.	5/16 "	533299	QBL-3/8-5/16-U	5
		3/8 "	533300	QBL-3/8-3/8-U	5
		1/2 "	533301	QBL-3/8-1/2-U	5
<b>Angled push-in fitting, long, with external hex</b>					
	Connecting thread 3/8 NPT for tubing O.D.	5/16 "	564679	QBL-3/8-5/16-U	5
		3/8 "	564680	QBL-3/8-3/8-U	5
		1/2 "	564681	QBL-3/8-1/2-U	5
<b>Silencer</b>					
	With connecting thread NPT, metal design	3/8 NPT	12740	U-3/8-B-NPT	1
	With connecting thread NPT, sintered design, long	3/8 NPT	1206991	AMTE-M-LH-N38	10

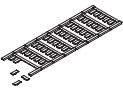
1) Packaging unit

Ordering data		Description	Weight [g]	Part no.	Type
<b>Foot mounting</b>					
	With screw set for attaching the valve to the foot mounting	239	8026337	VAME-B10-30-A	
<b>Wall mounting</b>					
	With screw set for attaching the valve to the wall mounting (for size 20, 25, 30)	53	576413	VAME-B10-20-W	
<b>Assortment of spare parts</b>					
	Set comprising seals and screws	22	8035637	VAME-B10-30-MK	
<b>Inscription label</b>					
	Frame with 40 labels	–	565306	ASLR-C-E4	
<b>Mounting kit</b>					
	With mounting bracket for lateral valve mounting	For standards-based cylinder DSBC-50...125	160	2612128	DAVM-MW-V1-50-V

Datasheet – Manifold block, size 20

-  - Flow rate  
up to 700 l/min

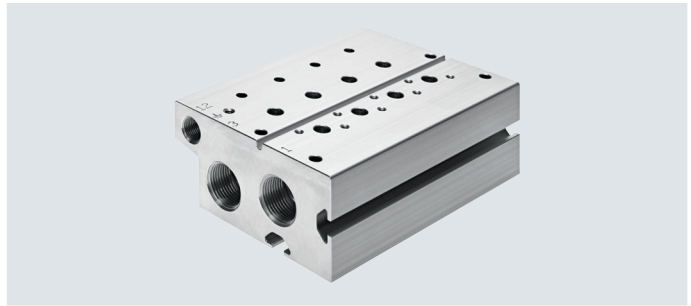

General technical data	Manifold block Standard		Manifold block Compact		Common supply manifold
					At both ends
Valve function	3/2	5/2, 5/3	3/2	5/2, 5/3	3/2, 5/2, 5/3
Grid dimension [mm]	22				
Type of mounting	With through-hole				With mounting bracket
Max. number of valve positions	10	10	10		10
Port 1	3/8 NPT	3/8 NPT	1/4 NPT	1/4 NPT	3/8 NPT
Connection 3	3/8 NPT	3/8 NPT	1/4 NPT	1/4 NPT	–
Connection 5	–	3/8 NPT	–	1/4 NPT	–
Port 12	1/8 NPT	1/8 NPT	–	–	–
Connection 14	–	1/8 NPT	–	–	–
CRC <sup>1)</sup>	21)				

1) More information [www.festo.com/x/topic/crc](http://www.festo.com/x/topic/crc)

Weight [g]									
Valve positions	2	3	4	5	6	7	8	9	10
<b>Manifold block for 3/2-way valves, standard</b>									
VABM-B10-20E-...N38-...-P3	449	574	699	825	950	1075	1200	1326	1451
<b>Manifold block for 5/2- and 5/3-way valves, standard</b>									
VABM-B10-20E-...N38-...	680	866	1053	1239	1425	1612	1798	1985	2171
<b>Manifold block for 3/2-way valves, compact</b>									
VABM-B10-20S-...N14-...-P3	280	360	441	521	601	681	762	842	922
<b>Manifold block for 5/2- and 5/3-way valves, compact</b>									
VABM-B10-20S-...N14-...	344	439	535	630	726	821	917	1012	1108
<b>Common supply manifold for mounting on both sides</b>									
VABM-B10-20-N38-...-P53	226	268	310	352	395	437	479	521	563

Materials	
Manifold rail	Wrought aluminium alloy
Note on materials	RoHS-compliant



## Datasheet – Manifold block, size 20

## Dimensions

Manifold block for 3/2-way valves, standard

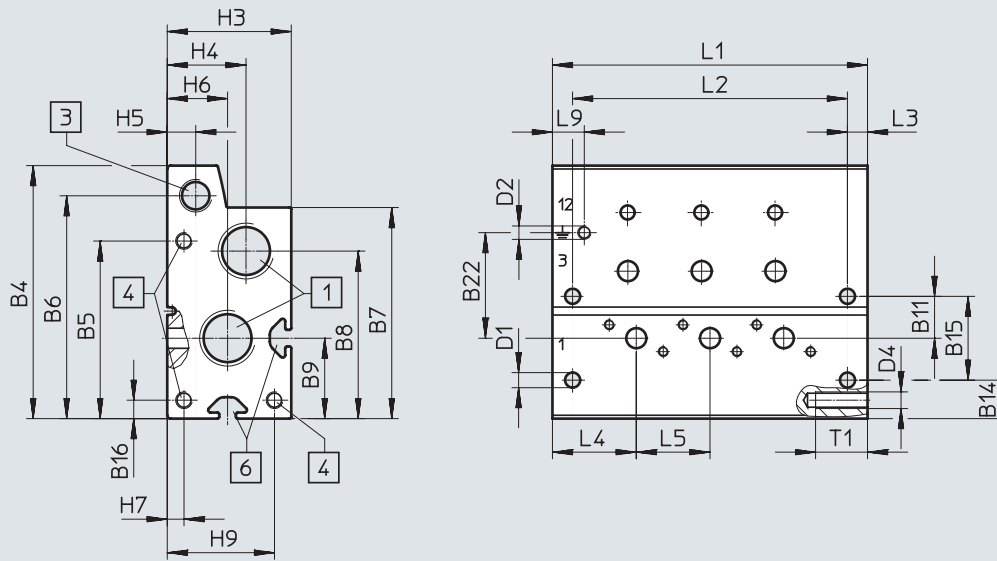

[1] Ports 1 and 3: 3/8 NPT

[3] Port 12: 1/8 NPT

[4] Thread M5x15.5 for extension module

[6] Profile slot IPM-05, system 5 module

Type	B4	B5	B6	B7	B8	B9	B11	B14	B15	B16	B22
VABM-B10-20E....N38-....P3	75.5	53	66.5	63	50	24	12.5	11.5	25	5.5	31.5

Type	D1 $\varnothing$	D2	D4	H3	H4	H5	H6	H7	H9	L3	L4	L5	L9	T1
VABM-B10-20E....N38-....P3	4.5	M4x6.5	M5	37	23.5	8.5	18	5	32	6	25	22	9.5	15.5

Valve positions	2	3	4	5	6	7	8	9	10
L1 [mm]	72	94	116	138	160	182	204	226	248
L2 [mm]	60	82	104	126	148	170	192	214	236

## Datasheet – Manifold block, size 20

### Dimensions

Manifold block for 5/2- and 5/3-way valves, standard

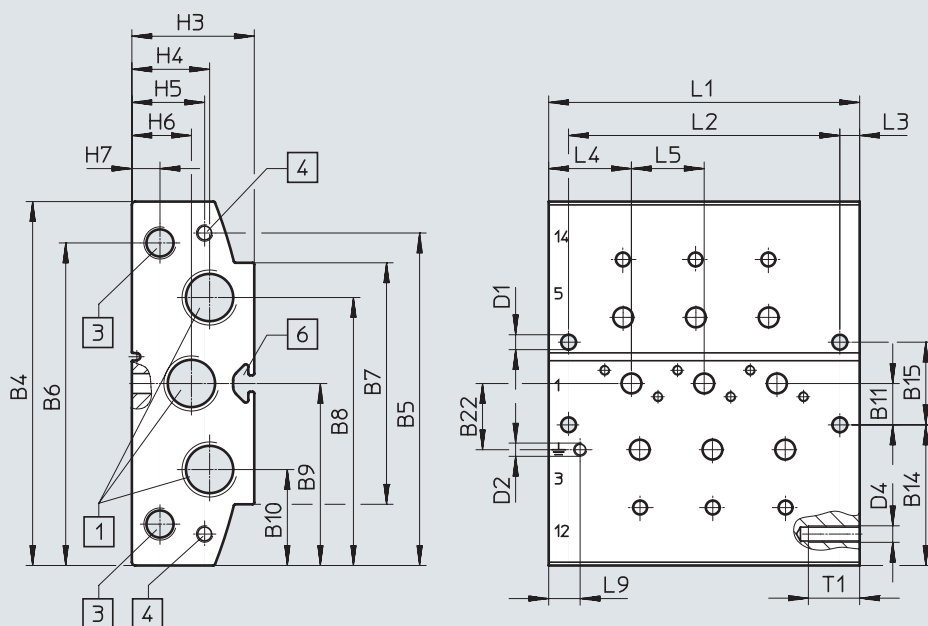

[1] Ports 1, 3 and 5: 3/8 NPT

[3] Ports 12 and 14: 1/8 NPT

[4] Thread M5x15.5 for extension module

[6] Profile slot IPM-05 system 5 module

Type	B4	B5	B6	B7	B8	B9	B10	B11	B14	B15	B22
VABM-B10-20E...N38-...	110	100.5	97.5	73	81	55	29	12.5	42.5	25	20

Type	D1 ø	D2	D4	H3	H4	H5	H6	H7	L3	L4	L5	L9	T1
VABM-B10-20E...N38-...	4.5	M4x6.5	M5	37	23.5	22	18	8.5	6	25	22	9.5	15.5

Valve positions	2	3	4	5	6	7	8	9	10
L1 [mm]	72	94	116	138	160	182	204	226	248
L2 [mm]	60	82	104	126	148	170	192	214	236

## Datasheet – Manifold block, size 20

## Dimensions

Manifold block for 3/2-way valves, compact

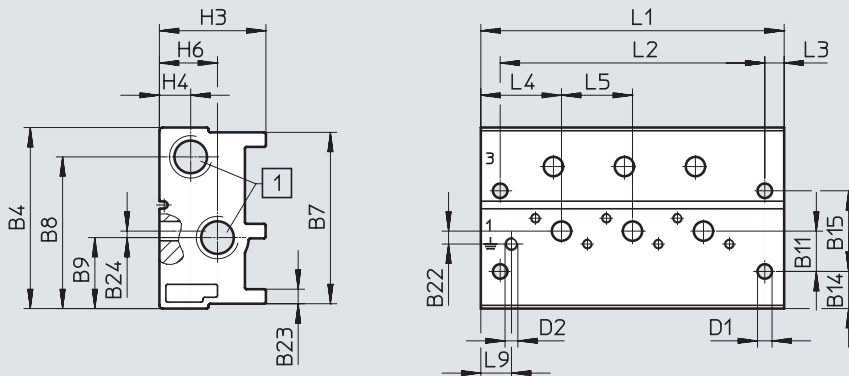

[1] Ports 1 and 3: 1/4 NPT

Type	B4	B7	B8	B9	B11	B14	B15	B22	B23	B24
VABM-B10-20S-...N14-...P3	56.1	53.1	47	22	12.5	11.5	25	4	4.5	2

Type	D1 $\varnothing$	D2	H3	H4	H6	L3	L4	L5	L9
VABM-B10-20S-...N14-...P3	4.5	M4x6.5	33	9.7	18	6	25	22	9.5

Valve positions	2	3	4	5	6	7	8	9	10
L1 [mm]	72	94	116	138	160	182	204	226	248
L2 [mm]	60	82	104	126	148	170	192	214	236

## Dimensions

Manifold block for 5/2- and 5/3-way valves, compact

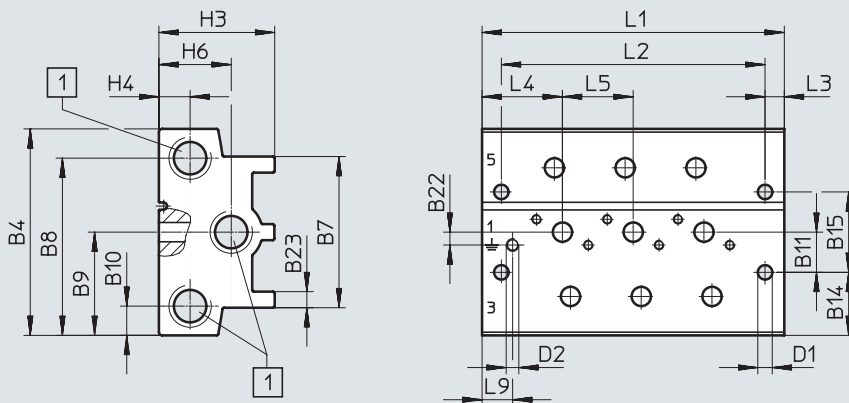

[1] Ports 1, 3 and 5: 1/4 NPT

Type	B4	B7	B8	B9	B10	B11	B14	B15	B22	B23
VABM-B10-20S-...N14-...	64.2	47	55.1	32.1	9.1	12.5	19.6	25	4	5

Type	D1 $\varnothing$	D2	H3	H4	H6	L3	L4	L5	L9
VABM-B10-20S-...N14-...	4.5	M4x6.5	36	9.7	22.5	6	25	22	9.5

Valve positions	2	3	4	5	6	7	8	9	10
L1 [mm]	72	94	116	138	160	182	204	226	248
L2 [mm]	60	82	104	126	148	170	192	214	236

Datasheet – Manifold block, size 20

**Dimensions**

Common supply manifold, for mounting on both sides

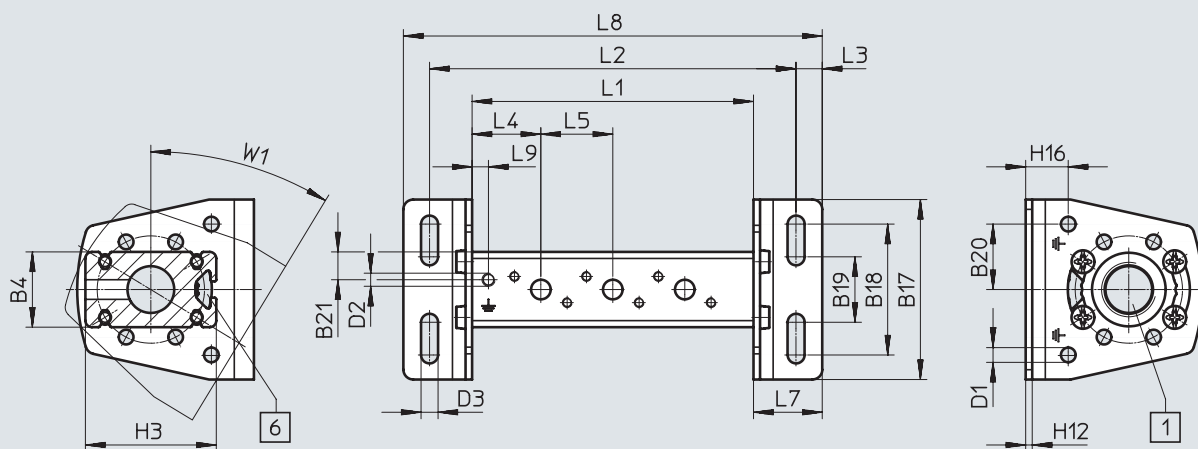

[1] Port 1: 3/8 NPT









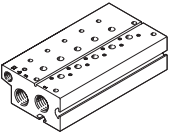

[6] Profile slot IPM-05 system 5

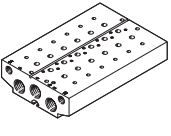
-  - **Note**  
Mounting bracket can be adjusted by  $\pm 30^\circ$ .

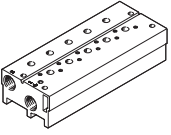

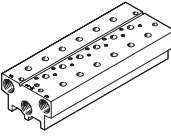

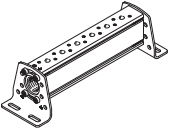

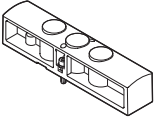
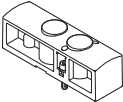

Type	B4	B17	B18	B19	B20	B21	D1 $\varnothing$	D2	D3 $\varnothing$	H3	H12	H16	L3	L4	L5	L7	L9	W1
VABM-B10-20-N38-...-P53	23	55	40	20	20	8.5	4.5	M4x6.5	5.2	40	2	13	8	21	22	21	5	30°

Valve positions	2	3	4	5	6	7	8	9	10
L1 [mm]	64	86	108	130	152	174	196	218	240
L2 [mm]	90	112	134	156	178	200	222	244	266
L8 [mm]	106	128	150	172	194	216	238	260	282

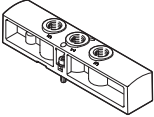
## Ordering data – Manifold block, size 20

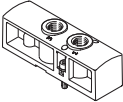
Ordering data – Manifold block			
Description	Valve positions	Part no.	Type
<b>Standard manifold block</b>			
 <p>For 3/2-way valves, incl. seals and screws for valve assembly</p> <p>-  - <b>Note</b> Blanking plugs for sealing the supply ports (1, 3 and 14) at one end are included in the scope of delivery.</p>	2	576453	VABM-B10-20E-N38-2-P3
	3	576454	VABM-B10-20E-N38-3-P3
	4	576455	VABM-B10-20E-N38-4-P3
	5	576456	VABM-B10-20E-N38-5-P3
	6	576457	VABM-B10-20E-N38-6-P3
	7	576458	VABM-B10-20E-N38-7-P3
	8	576459	VABM-B10-20E-N38-8-P3
	9	576460	VABM-B10-20E-N38-9-P3
	10	576461	VABM-B10-20E-N38-10-P3
	 <p>For 5/2- and 5/3-way valves, incl. seals and screws for valve assembly</p> <p>-  - <b>Note</b> Blanking plugs for sealing the supply ports (1, 3, 5, 12 and 14) on one side are included in the scope of delivery.</p>	2	576351
3		576352	VABM-B10-20E-N38-3
4		576353	VABM-B10-20E-N38-4
5		576354	VABM-B10-20E-N38-5
6		576355	VABM-B10-20E-N38-6
7		576356	VABM-B10-20E-N38-7
8		576357	VABM-B10-20E-N38-8
9		576358	VABM-B10-20E-N38-9
10		576359	VABM-B10-20E-N38-10
<b>Compact manifold block</b>			
 <p>For 3/2-way valves, incl. seals and screws for valve assembly</p> <p>-  - <b>Note</b> Blanking plugs for sealing the supply ports (1 and 3) on one side are included in the scope of delivery.</p>	2	576477	VABM-B10-20S-N14-2-P3
	3	576478	VABM-B10-20S-N14-3-P3
	4	576479	VABM-B10-20S-N14-4-P3
	5	576480	VABM-B10-20S-N14-5-P3
	6	576481	VABM-B10-20S-N14-6-P3
	7	576482	VABM-B10-20S-N14-7-P3
	8	576483	VABM-B10-20S-N14-8-P3
	9	576484	VABM-B10-20S-N14-9-P3
	10	576485	VABM-B10-20S-N14-10-P3
	 <p>For 5/2- and 5/3-way valves, incl. seals and screws for valve assembly</p> <p>-  - <b>Note</b> Blanking plugs for sealing the supply ports (1, 3 and 5) on one side are included in the scope of delivery.</p>	2	576429
3		576430	VABM-B10-20S-N14-3
4		576431	VABM-B10-20S-N14-4
5		576432	VABM-B10-20S-N14-5
6		576433	VABM-B10-20S-N14-6
7		576434	VABM-B10-20S-N14-7
8		576435	VABM-B10-20S-N14-8
9		576436	VABM-B10-20S-N14-9
10		576437	VABM-B10-20S-N14-10
<b>Common supply manifold</b>			
 <p>For mounting on both sides, incl. seals and screws for valve assembly</p> <p>-  - <b>Note</b> Blanking plug for sealing the supply port (1) at one end included in the scope of delivery.</p>	2	576375	VABM-B10-20-N38-2-P53
	3	576376	VABM-B10-20-N38-3-P53
	4	576377	VABM-B10-20-N38-4-P53
	5	576378	VABM-B10-20-N38-5-P53
	6	576379	VABM-B10-20-N38-6-P53
	7	576380	VABM-B10-20-N38-7-P53
	8	576381	VABM-B10-20-N38-8-P53
	9	576382	VABM-B10-20-N38-9-P53
	10	576383	VABM-B10-20-N38-10-P53

Accessories – Manifold block, size 20

Ordering data				
Description	Weight [g]	Part no.	Type	
<b>Cover plate</b>				
	For valve position on manifold block for 5/2-way, 5/3-way valves	78	<b>576410</b>	<b>VABB-B10-20-E</b>
	For valve position on manifold block for 3/2-way valves	56	<b>576411</b>	<b>VABB-B10-20-E-P3</b>
	For valve position on common supply manifold	13	<b>576409</b>	<b>VABB-B10-20-A</b>
<b>Supply plate</b>				
	For valve position on manifold block for 5/2-way, 5/3-way valves  -  - <b>Note</b> Supply plates and air supply plates are only available with G thread.	78	<b>576492</b>	<b>VABF-B10-20-P1A4-G18</b>
	For valve position on manifold block for 3/2-way valves  -  - <b>Note</b> Supply plates and air supply plates are only available with G thread.	56	<b>576493</b>	<b>VABF-B10-20-P1A4-G18-P3</b>
<b>Air supply plate</b>				
	For valve position on common supply manifold  -  - <b>Note</b> Supply plates and air supply plates are only available with G thread.	13	<b>576491</b>	<b>VABF-B10-20-P1-G18</b>





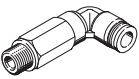

Ordering data					
Description of NPT thread	Part no.	Type	PU <sup>1)</sup>		
<b>Push-in fitting with internal hex</b>					
	Connecting thread 1/8 NPT for tubing O.D.	5/32 "	<b>572317</b>	<b>QB-1/8-5/32-I-U</b>	<b>10</b>
		1/4 "	<b>572318</b>	<b>QB-1/8-1/4-I-U</b>	<b>10</b>
		5/16 "	<b>572319</b>	<b>QB-1/8-5/16-I-U</b>	<b>10</b>
	Connecting thread 1/4 NPT for tubing O.D.	5/16 "	<b>572321</b>	<b>QB-1/4-5/16-I-U</b>	<b>10</b>
		3/8 "	<b>572322</b>	<b>QB-1/4-3/8-I-U</b>	<b>10</b>
		1/2 "	<b>567771</b>	<b>QB-1/4-1/2-U</b>	<b>10</b>
	Connecting thread 3/8 NPT for tubing O.D.	5/16 "	<b>572323</b>	<b>QB-3/8-5/16-I-U</b>	<b>10</b>
		3/8 "	<b>572324</b>	<b>QB-3/8-3/8-I-U</b>	<b>10</b>
		1/2 "	<b>572325</b>	<b>QB-3/8-1/2-I-U</b>	<b>10</b>

1) Packaging unit

## Accessories – Manifold block, size 20

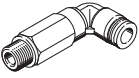

Ordering data		Description of NPT thread	Part no.	Type	PU <sup>1)</sup>
<b>Angled push-in fitting, with external hex</b>					
	Connecting thread 1/8 NPT for tubing O.D.	5/32 "	533290	QBL-1/8-5/32-U	10
		1/4 "	533292	QBL-1/8-1/4-U	10
		5/16 "	533293	QBL-1/8-5/16-U	10
	Connecting thread 1/4 NPT for tubing O.D.	5/16 "	533296	QBL-1/4-5/16-U	10
		3/8 "	533297	QBL-1/4-3/8-U	5
		1/2 "	567775	QBL-1/4-1/2-U	5
	Connecting thread 3/8 NPT for tubing O.D.	5/16 "	533299	QBL-3/8-5/16-U	5
		3/8 "	533300	QBL-3/8-3/8-U	5
		1/2 "	533301	QBL-3/8-1/2-U	5
<b>Angled push-in fitting, long, with external hex</b>					
	Connecting thread 1/8 NPT for tubing O.D.	5/32 "	564668	QBLL-1/8-5/32-U	10
		1/4 "	564670	QBLL-1/8-1/4-U	10
		5/16 "	564671	QBLL-1/8-5/16-U	10

1) Packaging unit





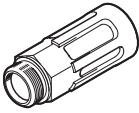

Ordering data		Description of G thread	Part no.	Type	PU <sup>1)</sup>
<b>Push-in fitting with internal hex</b>					
	Connecting thread G1/8 for tubing O.D.   - <b>Note</b> Push-in fittings with G thread are for supply plates and air supply plates only.	4 mm	186106	QS-G1/8-4-I	10
			133008	QS-G1/8-4-I-100	100
		6 mm	186107	QS-G1/8-6-I	10
			133009	QS-G1/8-6-I-100	100
		8 mm	186109	QS-G1/8-8-I	10
			133010	QS-G1/8-8-I-100	100
<b>Angled push-in fitting, with external hex</b>					
	Connecting thread G1/8 for tubing O.D.   - <b>Note</b> Push-in fittings with G thread are for supply plates and air supply plates only.	4 mm	186116	QSL-G1/8-4	10
			132048	QSL-G1/8-4-100	100
		6 mm	186117	QSL-G1/8-6	10
			132049	QSL-G1/8-6-100	100
		8 mm	186119	QSL-G1/8-8	10
			132050	QSL-G1/8-8-50	50
<b>Angled push-in fitting, long, with external hex</b>					
	Connecting thread G1/8 for tubing O.D.   - <b>Note</b> Push-in fittings with G thread are for supply plates and air supply plates only.	4 mm	186127	QSL-G1/8-4	10
			133015	QSL-G1/8-4-100	100
		6 mm	186128	QSL-G1/8-6	10
			133016	QSL-G1/8-6-100	100
		8 mm	186130	QSL-G1/8-8	10
			133017	QSL-G1/8-8-100	100

1) Packaging unit

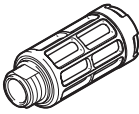
Accessories – Manifold block, size 20

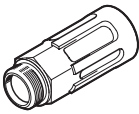
Ordering data		Description of NPT thread	Part no.	Type	PU <sup>1)</sup>
<b>Silencer</b>					
	With connecting thread NPT, metal design	1/4 NPT	12639	U-1/4-B-NPT	1
		3/8 NPT	12740	U-3/8-B-NPT	1
	With connecting thread NPT, sintered design, long	1/4 NPT	1206990	AMTE-M-LH-N14	20
		3/8 NPT	1206991	AMTE-M-LH-N38	20



1) Packaging unit

Ordering data		Description of G thread	Part no.	Type	PU <sup>1)</sup>
<b>Silencer</b>					
	With connecting thread G, polymer version	G1/8	2307	U-1/8	1
			534222	U-1/8-50	50
<p>-  - <b>Note</b> Silencers with G thread are for supply plates and air supply plates only.</p>					
	With connecting thread G, metal version	G1/8	6841	U-1/8-B	1
			<p>-  - <b>Note</b> Silencers with G thread are for supply plates and air supply plates only.</p>		
	With connecting thread G, sintered version, long	G1/8	1205860	AMTE-M-LH-G18	20
			<p>-  - <b>Note</b> Silencers with G thread are for supply plates and air supply plates only.</p>		

1) Packaging unit



## Accessories – Manifold block, size 20

Ordering data					
	Description		Part no.	Type	PU <sup>1)</sup>
<b>Blanking plug</b>					
	With connecting thread NPT	1/8 NPT	173985	B-1/8-NPT	1
		1/4 NPT	174165	B-1/4-NPT	1
		3/8 NPT	174169	B-3/8-NPT	1
<b>Separator</b>					
	For creating pressure zones	G1/8 1/8 NPT	569995	VABD-8-B	1
		G1/4 1/4 NPT	569996	VABD-10-B	1
		G3/8 3/8 NPT	574483	VABD-14-B	1
<b>DIN rail mounting</b>					
	For mounting the valve manifold assembly on standard DIN rail TH 35-7.5 or TH 35-15, to EN 60715		569998	VAME-T-M4	1

1) Packaging unit

Datasheet – Manifold block, size 25

-  - Flow rate  
up to 1300 l/min

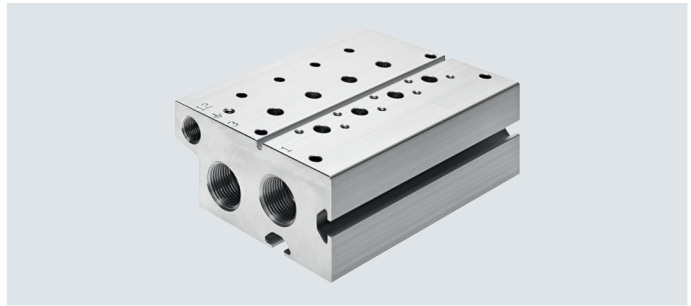

General technical data					
	Manifold block Standard		Manifold block Compact		Common supply manifold
					At both ends
For valves	3/2	5/2, 5/3	3/2	5/2, 5/3	3/2, 5/2, 5/3
Grid dimension [mm]	27.5				
Type of mounting	With through-hole				With mounting bracket
Maximum number of valve positions	10	10	10	10	10
Port 1	1/2 NPT	1/2 NPT	3/8 NPT	3/8 NPT	1/2 NPT
Connection 3	1/2 NPT	1/2 NPT	3/8 NPT	3/8 NPT	–
Connection 5	–	1/2 NPT	–	3/8 NPT	–
Port 12	1/8 NPT	1/8 NPT	–	–	–
Connection 14	–	1/8 NPT	–	–	–
CRC <sup>1)</sup>	21)				

1) More information [www.festo.com/x/topic/crc](http://www.festo.com/x/topic/crc)

Weight [g]									
Valve positions	2	3	4	5	6	7	8	9	10
<b>Manifold block for 3/2-way valves, standard</b>									
VABM-B10-25E-...N12-...-P3	729	963	1197	1431	1665	1899	2133	2367	2601
<b>Manifold block for 5/2- and 5/3-way valves, standard</b>									
VABM-B10-25E-...N12-...	932	1229	1526	1823	2120	2417	2714	3011	3308
<b>Manifold block for 3/2-way valves, compact</b>									
VABM-B10-25S-...N38-...-P3	371	490	609	728	847	966	1085	1204	1323
<b>Manifold block for 5/2- and 5/3-way valves, compact</b>									
VABM-B10-25S-...N38-...	440	581	722	863	1004	1145	1286	1427	1568
<b>Common supply manifold for mounting on both sides</b>									
VABM-B10-25-...N12-...-P53	260	342	424	506	588	670	752	834	916

Materials	
Manifold rail	Wrought aluminium alloy
Note on materials	RoHS-compliant

-  - **Note**  
Manifold blocks VABM in size 25 cannot be used in combination with VUVS-...-FN

Datasheet – Manifold block, size 25

**Dimensions**

Manifold block for 3/2-way valves, standard

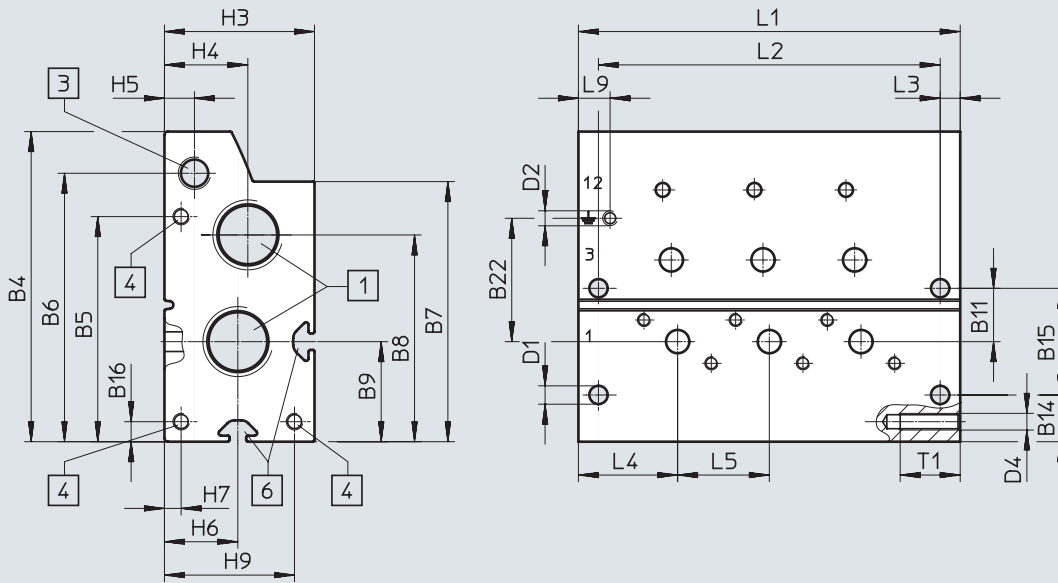

- [1] Ports 1 and 3 (on both sides): 1/2 NPT
- [3] Ports 12 (on both sides): 1/8 NPT
- [4] Thread M5x18 for extension module
- [6] Profile slot IPM-05, system 5

Type	B4	B5	B6	B7	B8	B9	B11	B14	B15	B16	B22
VABM-B10-25-E-...N12-...-P3	93	67.5	80.5	78	62	30	16	14	32	6	37

Type	D1 ø	D2	D4	H3	H4	H5	H6	H7	H9	L3	L4	L5	L9	T1
VABM-B10-25-E-...N12-...-P3	5.5	M4x9	M5	45	25	9	22	5	39	6	29.8	27.5	9.5	18

Valve positions	2	3	4	5	6	7	8	9	10
L1 [mm]	87	114.5	142	169.5	197	224.5	252	279.5	307
L2 [mm]	75	102.5	130	157.5	185	212.5	240	267.5	295

## Datasheet – Manifold block, size 25

### Dimensions

Manifold block for 5/2- and 5/3-way valves, standard

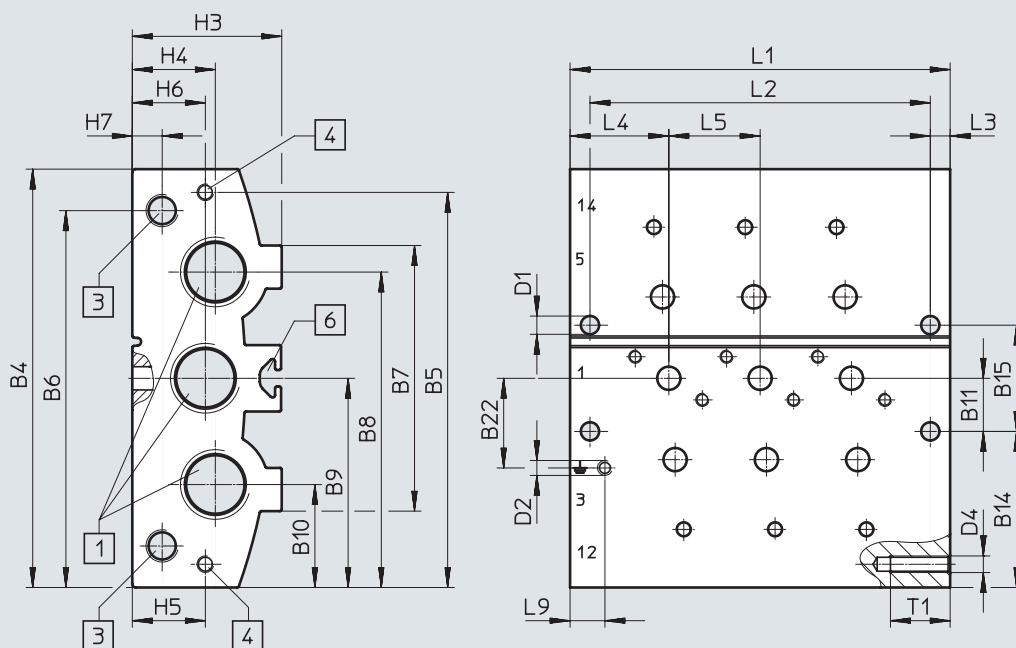

[1] Ports 1, 3 and 5 (on both sides):  
1/2 NPT

[3] Ports 12 and 14 (on both sides):  
1/8 NPT

[4] Thread M5x18 for extension  
module

[6] Profile slot IPM-05, system 5

Type	B4	B5	B6	B7	B8	B9	B10	B11	B14	B15	B22
VABM-B10-25E-...-N12-...	126	119	113.5	80	95	63	31	16	47	32	27

Type	D1 ø	D2	D4	H3	H4	H5	H6	H7	L3	L4	L5	L9	T1
VABM-B10-25E-...-N12-...	5.5	M4x9	M5	45	25	22	22	9	6	29.8	27.5	10.5	18

Valve positions	2	3	4	5	6	7	8	9	10
L1 [mm]	87	114.5	142	169.5	197	224.5	252	279.5	307
L2 [mm]	75	102.5	130	157.5	185	212.5	240	267.5	295

## Datasheet – Manifold block, size 25

## Dimensions

Manifold block for 3/2-way valves, compact

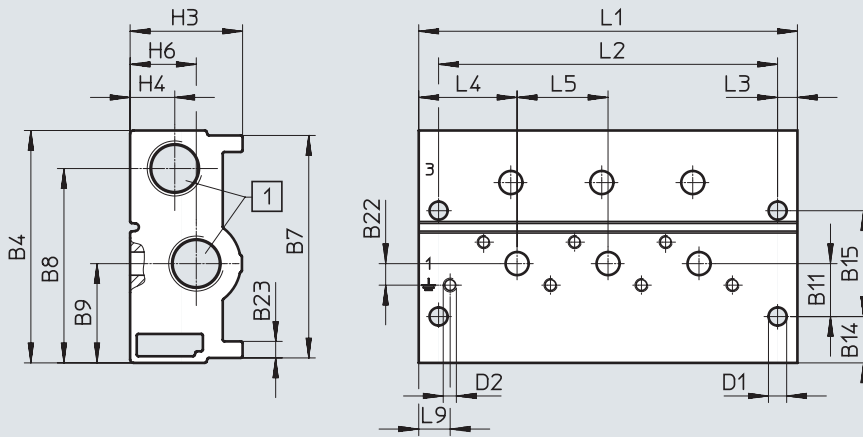

[1] Ports 1 and 3 (on both sides):  
3/8 NPT

Type	B4	B7	B8	B9	B11	B14	B15	B22	B23
VABM-B10-25S-...N38-...P3	70.3	67.3	58.8	30	16	14	32	6.5	5

Type	D1 $\varnothing$	D2	H3	H4	H6	L3	L4	L5	L9
VABM-B10-25S-...N38-...P3	5.5	M4x9	34	13.5	20	6	29.8	27.5	9.5

Valve positions	2	3	4	5	6	7	8	9	10
L1 [mm]	87	114.5	142	169.5	197	224.5	252	279.5	307
L2 [mm]	75	102.5	130	157.5	185	212.5	240	267.5	295

Datasheet – Manifold block, size 25

**Dimensions**

Manifold block for 5/2- and 5/3-way valves, compact

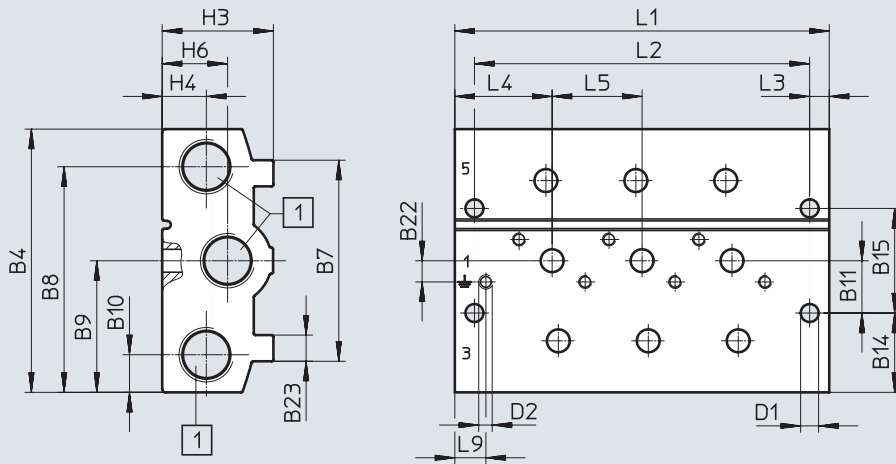

[1] Ports 1, 3 and 5 (on both sides):  
3/8 NPT

Type	B4	B7	B8	B9	B10	B11	B14	B15	B22	B23
VABM-B10-25S-...N38-...	80.5	61.5	69	40.3	11.5	16	24.3	32	6.5	8

Type	D1 ø	D2	H3	H4	H6	L3	L4	L5	L9
VABM-B10-25S-...N38-...	5.5	M4x9	34	13.5	20	6	29.8	27.5	9.5

Valve positions	2	3	4	5	6	7	8	9	10
L1 [mm]	87	114.5	142	169.5	197	224.5	252	279.5	307
L2 [mm]	75	102.5	130	157.5	185	212.5	240	267.5	295

## Datasheet – Manifold block, size 25

### Dimensions

Common supply manifold, for mounting on both sides

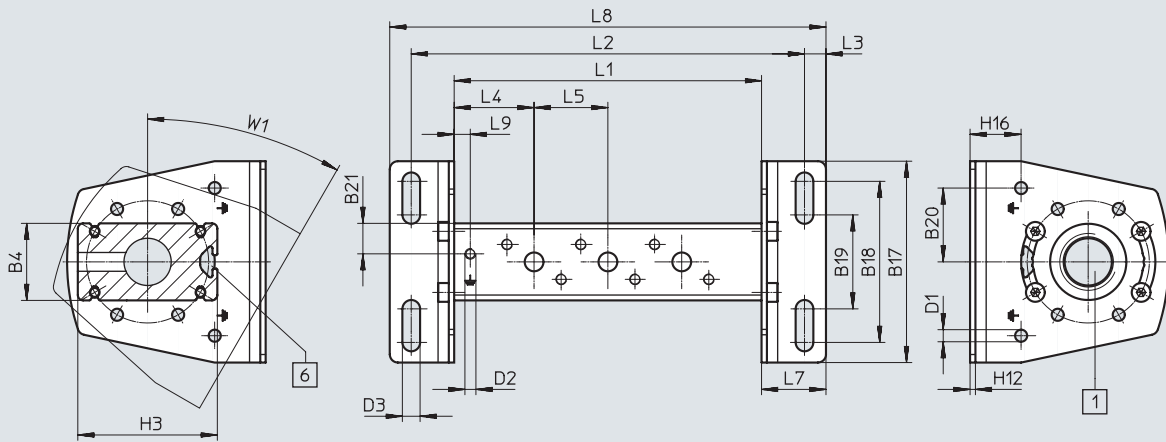

[1] Port 1: (on both sides): 1/2 NPT

[6] Profile slot IPM-05, system 5









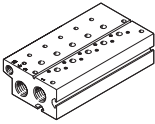

**Note**  
Mounting bracket can be adjusted by  $\pm 30^\circ$

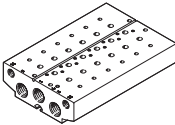
Type	B4	B17	B18	B19	B20	B21	D1 $\varnothing$	D2	D3 $\varnothing$	H3	H12	H16	L3	L4	L5	L7	L9	W1
VABM-B10-25-N12-...-P53	28.7	75	60	35	27.5	11.4	4.5	M4x9	6.6	52	2	19	8	29.8	27.5	24	6	30

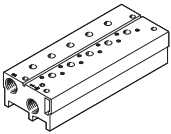

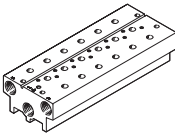

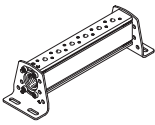

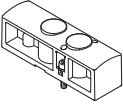
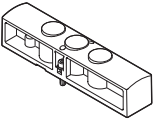

Valve positions	2	3	4	5	6	7	8	9	10
L1 [mm]	87	114.5	142	169.5	197	224.5	252	279.5	307
L2 [mm]	119	146.5	174	201.5	229	256.5	284	311.5	339
L8 [mm]	135	162.5	190	217.5	245	272.5	300	327.5	355

## Ordering data – Manifold block, size 25

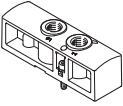

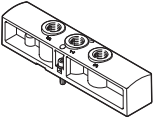
Ordering data		Valve positions	Part no.	Type
Description				
<b>Standard manifold block</b>				
 <p>For 3/2-way valves, incl. seals and screws for valve assembly</p> <p>-  - <b>Note</b></p> <p>Blanking plugs for sealing the supply ports (1, 3 and 14) at one end are included in the scope of delivery.</p>		2	8026288	VABM-B10-25E-N12-2-P3
		3	8026289	VABM-B10-25E-N12-3-P3
		4	8026290	VABM-B10-25E-N12-4-P3
		5	8026291	VABM-B10-25E-N12-5-P3
		6	8026292	VABM-B10-25E-N12-6-P3
		7	8026293	VABM-B10-25E-N12-7-P3
		8	8026294	VABM-B10-25E-N12-8-P3
		9	8026295	VABM-B10-25E-N12-9-P3
		10	8026296	VABM-B10-25E-N12-10-P3
	 <p>For 5/2- and 5/3-way valves, incl. seals and screws for valve assembly</p> <p>-  - <b>Note</b></p> <p>Blanking plugs for sealing the supply ports (1, 3, 5, 12 and 14) on one side are included in the scope of delivery.</p>		2	8026252
		3	8026253	VABM-B10-25E-N12-3
		4	8026254	VABM-B10-25E-N12-4
		5	8026255	VABM-B10-25E-N12-5
		6	8026256	VABM-B10-25E-N12-6
		7	8026257	VABM-B10-25E-N12-7
		8	8026258	VABM-B10-25E-N12-8
		9	8026259	VABM-B10-25E-N12-9
		10	8026260	VABM-B10-25E-N12-10
<b>Compact manifold block</b>				
 <p>For 3/2-way valves, incl. seals and screws for valve assembly</p> <p>-  - <b>Note</b></p> <p>Blanking plugs for sealing the supply ports (1 and 3) on one side are included in the scope of delivery.</p>		2	8026306	VABM-B10-25S-N38-2-P3
		3	8026307	VABM-B10-25S-N38-3-P3
		4	8026308	VABM-B10-25S-N38-4-P3
		5	8026309	VABM-B10-25S-N38-5-P3
		6	8026310	VABM-B10-25S-N38-6-P3
		7	8026311	VABM-B10-25S-N38-7-P3
		8	8026312	VABM-B10-25S-N38-8-P3
		9	8026313	VABM-B10-25S-N38-9-P3
		10	8026314	VABM-B10-25S-N38-10-P3
	 <p>For 5/2- and 5/3-way valves, incl. seals and screws for valve assembly</p> <p>-  - <b>Note</b></p> <p>Blanking plugs for sealing the supply ports (1, 3 and 5) on one side are included in the scope of delivery.</p>		2	8026270
		3	8026271	VABM-B10-25S-N38-3
		4	8026272	VABM-B10-25S-N38-4
		5	8026273	VABM-B10-25S-N38-5
		6	8026274	VABM-B10-25S-N38-6
		7	8026275	VABM-B10-25S-N38-7
		8	8026276	VABM-B10-25S-N38-8
		9	8026277	VABM-B10-25S-N38-9
		10	8026278	VABM-B10-25S-N38-10
<b>Common supply manifold</b>				
 <p>For mounting on both sides, incl. seals and screws for valve assembly</p> <p>-  - <b>Note</b></p> <p>Blanking plug for sealing the supply port (1) at one end included in the scope of delivery.</p>		2	8026228	VABM-B10-25-N12-2-P53
		3	8026229	VABM-B10-25-N12-3-P53
		4	8026230	VABM-B10-25-N12-4-P53
		5	8026231	VABM-B10-25-N12-5-P53
		6	8026232	VABM-B10-25-N12-6-P53
		7	8026233	VABM-B10-25-N12-7-P53
		8	8026234	VABM-B10-25-N12-8-P53
		9	8026235	VABM-B10-25-N12-9-P53
		10	8026236	VABM-B10-25-N12-10-P53









## Accessories – Manifold block, size 25

Ordering data				
Description		Weight [g]	Part no.	Type
<b>Cover plate</b>				
	For valve position on manifold block for 3/2-way valves	84	<b>8026210</b>	<b>VABB-B10-25-E-P3</b>
	For valve position on manifold block for 5/2-way, 5/3-way valves	117	<b>8026209</b>	<b>VABB-B10-25-E</b>
	For valve position on common supply manifold	28	<b>8026208</b>	<b>VABB-B10-25-A</b>
<b>Supply plate</b>				
	For valve position on manifold block for 3/2-way valves  -  - <b>Note</b> Supply plates and air supply plates are only available with G thread.	80	<b>8026319</b>	<b>VABF-B10-25-P1A4-G14-P3</b>
	For valve position on manifold block for 5/2-way, 5/3-way valves  -  - <b>Note</b> Supply plates and air supply plates are only available with G thread.	110	<b>8026318</b>	<b>VABF-B10-25-P1A4-G14</b>
<b>Air supply plate</b>				
	For valve position on common supply manifold  -  - <b>Note</b> Supply plates and air supply plates are only available with G thread.	26	<b>8026317</b>	<b>VABF-B10-25-P1-G14</b>

## Accessories – Manifold block, size 25



Ordering data	Description of NPT thread	Part no.	Type	PU <sup>1)</sup>	
<b>Push-in fitting with internal hex</b>					
	Connecting thread 1/8 NPT for tubing O.D.	1/4 "	572318	QB-1/8-1/4-I-U	10
	Connecting thread 3/8 NPT for tubing O.D.	5/16 "	572323	QB-3/8-5/16-I-U	10
		3/8 "	572324	QB-3/8-3/8-I-U	10
		1/2 "	572325	QB-3/8-1/2-I-U	10
	Connecting thread 1/2 NPT for tubing O.D.	1/2 "	572326	QB-1/2-1/2-I-U	10
<b>Push-in fitting with external hex</b>					
	Connecting thread 1/2 NPT for tubing O.D.	3/8 "	533283	QB-1/2-3/8-U	5
<b>Angled push-in fitting, with external hex</b>					
	Connecting thread 3/8 NPT for tubing O.D.	5/16 "	533299	QBL-3/8-5/16-U	5
		3/8 "	533300	QBL-3/8-3/8-U	5
		1/2 "	533301	QBL-3/8-1/2-U	5
	Connecting thread 1/2 NPT for tubing O.D.	3/8 "	533302	QBL-1/2-3/8-U	5
		1/2 "	533303	QBL-1/2-1/2-U	5

1) Packaging unit

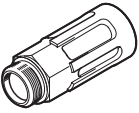

Ordering data	Description of G thread	Part no.	Type	PU <sup>1)</sup>		
<b>Push-in fitting with internal hex</b>						
	Connecting thread G1/4 for tubing O.D.	6 mm	186108	QS-G1/4-6-I	10	
	 - <b>Note</b> Push-in fittings with G thread are for supply plates and air supply plates only.	8 mm	186110	QS-G1/4-8-I	10	
		10 mm	186112	QS-G1/4-10-I	10	
<b>Angled push-in fitting, with external hex</b>						
	 - <b>Note</b> Push-in fittings with G thread are for supply plates and air supply plates only.	Connecting thread G1/4 for tubing O.D.	6 mm	186118	QSL-G1/4-6	10
		8 mm	132051	QSL-G1/4-6-100	100	
		8 mm	186120	QSL-G1/4-8	10	
		10 mm	132052	QSL-G1/4-8-50	50	
		10 mm	186122	QSL-G1/4-10	10	
<b>Angled push-in fitting, long, with external hex</b>						
	 - <b>Note</b> Push-in fittings with G thread are for supply plates and air supply plates only.	Connecting thread G1/4 for tubing O.D.	6 mm	186129	QSL-G1/4-6	10
		8 mm	186131	QSL-G1/4-8	10	
		10 mm	186133	QSL-G1/4-10	10	

1) Packaging unit

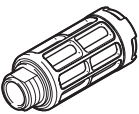

## Accessories – Manifold block, size 25

Ordering data		Description of NPT thread	Part no.	Type	PU <sup>1)</sup>
<b>Silencer</b>					
	With connecting thread NPT, metal design	3/8 NPT	12740	U-3/8-B-NPT	1
		1/2 NPT	12741	U-1/2-B-NPT	1
	With connecting thread NPT, sintered design, long	3/8 NPT	1206991	AMTE-M-LH-N38	20
		1/2 NPT	1206992	AMTE-M-LH-N12	10

1) Packaging unit

Ordering data		Description of G thread	Part no.	Type	PU <sup>1)</sup>
<b>Silencer</b>					
	With connecting thread G, polymer version	G1/4	2316	U-1/4	1
			534223	U-1/4-20	20
	With connecting thread G, sintered version, long	G1/4	1205861	AMTE-M-LH-G1	20

1) Packaging unit

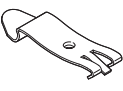
Ordering data		Description	Part no.	Type	PU <sup>1)</sup>
<b>Blanking plug</b>					
	With connecting thread NPT	1/8 NPT	173985	B-1/8-NPT	1
		3/8 NPT	174169	B-3/8-NPT	1
		1/2 NPT	31785	B-1/2-NPT	1
<b>Separator</b>					
	For creating pressure zones for port	G1/8	569995	VABD-8-B	1
		1/8 NPT			
		G1/4	569996	VABD-10-B	1
		1/4 NPT			
G3/8	574483	VABD-14-B	1		
3/8 NPT					
<b>DIN rail mounting</b>					
	For size 25, for mounting on standard TH 357.5 or TH 3515 DIN rails to EN 60715		2636436	VAME-T-M5	2

1) Packaging unit

Datasheet – Manifold block, size 30

-  - Flow rate  
up to 2300 l/min

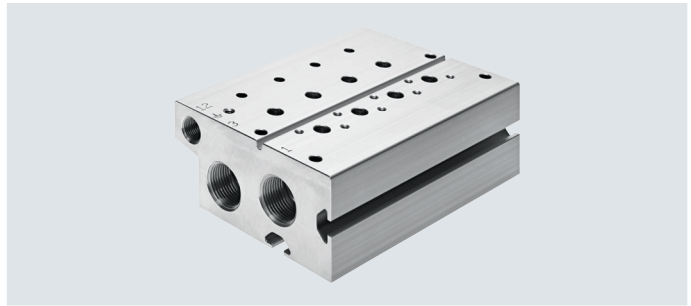

General technical data	Manifold block Standard		Manifold block Compact		Common supply manifold At both ends
	Valve function	3/2	5/2, 5/3	3/2	5/2, 5/3
Grid dimension [mm]	32				
Type of mounting	With through-hole				With mounting bracket
Max. number of valve positions	10	10	10		10
Port 1	3/4 NPT	3/4 NPT	1/2 NPT	1/2 NPT	3/4 NPT
Connection 3	3/4 NPT	3/4 NPT	1/2 NPT	1/2 NPT	–
Connection 5	–	3/4 NPT	–	1/2 NPT	–
Port 12	1/8 NPT	1/8 NPT	–	–	–
Connection 14	–	1/8 NPT	–	–	–
CRC <sup>1)</sup>	2)				

1) More information [www.festo.com/x/topic/crc](http://www.festo.com/x/topic/crc)

Weight [g]										
Valve positions	2	3	4	5	6	7	8	9	10	
<b>Manifold block for 3/2-way valves, standard</b>										
VABM-B10-30E-N34-...-P3	1411	1828	2245	2662	3079	3496	3913	4330	4747	
<b>Manifold block for 5/2- and 5/3-way valves, standard</b>										
VABM-B10-30E-N34-...	1722	2213	2703	3194	3684	4175	4665	5156	5646	
<b>Manifold block for 3/2-way valves, compact</b>										
VABM-B10-30S-N12-...-P3	652	872	1093	1313	1533	1753	1973	2193	2413	
<b>Manifold block for 5/2- and 5/3-way valves, compact</b>										
VABM-B10-30S-N12-...	759	1013	1267	1522	1776	2030	2285	2539	2793	
<b>Common supply manifold for mounting on both sides</b>										
VABM-B10-30-N34-...-P53	818	977	1135	1293	1452	1610	1768	1927	2085	

Materials	
Manifold rail	Wrought aluminium alloy
Note on materials	RoHS-compliant

Datasheet – Manifold block, size 30

**Dimensions**

Manifold block for 3/2-way valves, standard

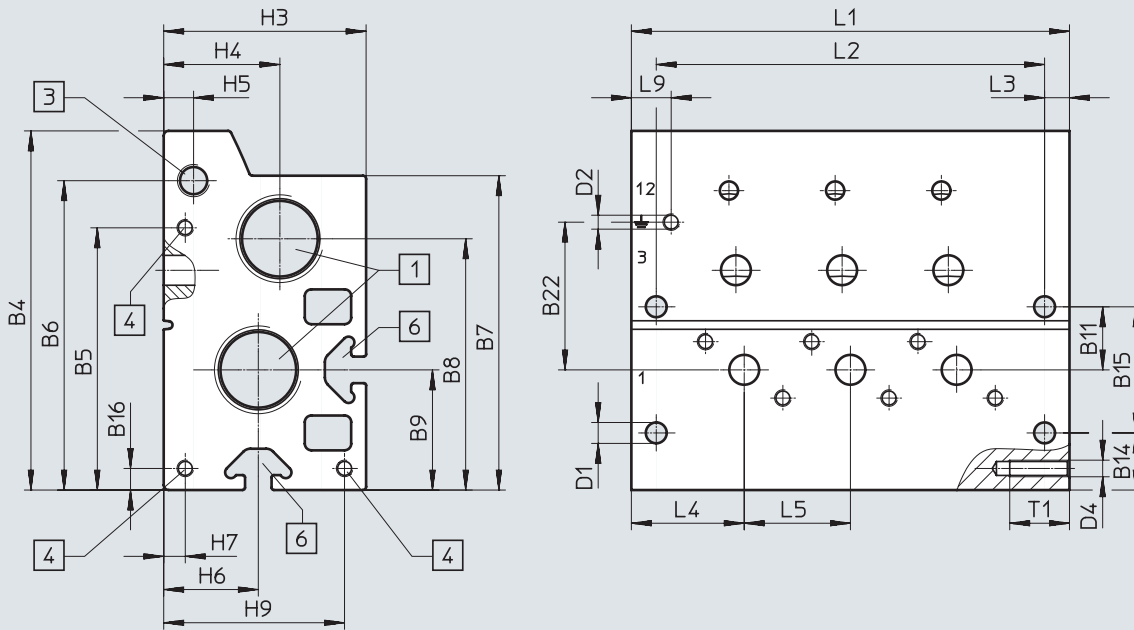

[1] Ports 1 and 3: 3/4 NPT

[3] Port 12: 1/8 NPT

[4] Thread M5x18 for extension module

[6] Profile slot IPM-08 system 8 module

Type	B4	B5	B6	B7	B8	B9	B11	B14	B15	B16	B22
VABM-B10-30E-N34-...-P3	108.2	79	93.2	94.7	75.7	36.2	19	17.2	38	6.5	44.5

Type	D1 ø	D2	D4	H3	H4	H5	H6	H7	H9	L3	L4	L5	L9	T1
VABM-B10-30E-N34-...-P3	6.3	M5x11	M5	61	35	9	28.5	6.5	54.5	7.5	34	32	12	18

Valve positions	2	3	4	5	6	7	8	9	10
L1 [mm]	100	132	164	196	228	260	292	324	356
L2 [mm]	85	117	149	181	213	245	277	309	341

Datasheet – Manifold block, size 30

**Dimensions**

Manifold block for 5/2- and 5/3-way valves, standard

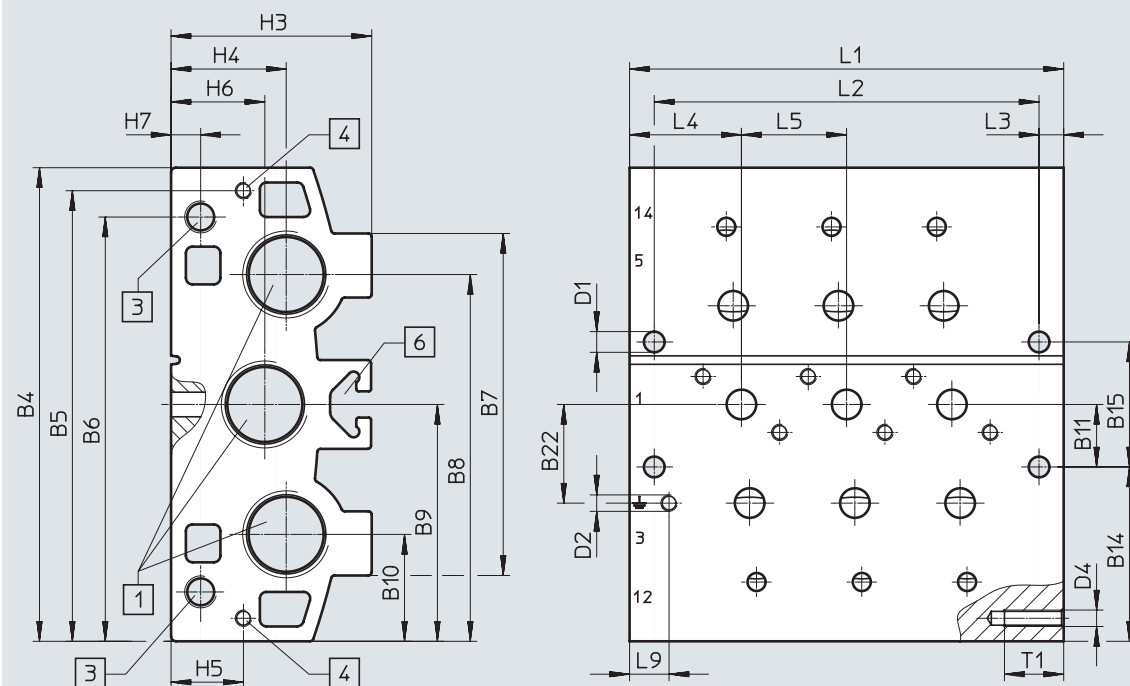

[1] Ports 1, 3 and 5: 3/4 NPT

[3] Ports 12 and 14: 1/8 NPT

[4] Thread M5x18 for extension module

[6] Profile slot IPM-08 system 8

Type	B4	B5	B6	B7	B8	B9	B10	B11	B14	B15	B22
VABM-B10-30E-N34-...	144	137	129	104	111.5	72	32.5	19	53	38	30

Type	D1 ø	D2	D4	H3	H4	H5	H6	H7	L3	L4	L5	L9	T1
VABM-B10-30E-N34-...	6.3	M5x11	M5	61	35	22	28.5	9	7.5	34	32	12	18

Valve positions	2	3	4	5	6	7	8	9	10
L1 [mm]	100	132	164	196	228	260	292	324	356
L2 [mm]	85	117	149	181	213	245	277	309	341

## Datasheet – Manifold block, size 30

## Dimensions

Manifold block for 3/2-way valves, compact

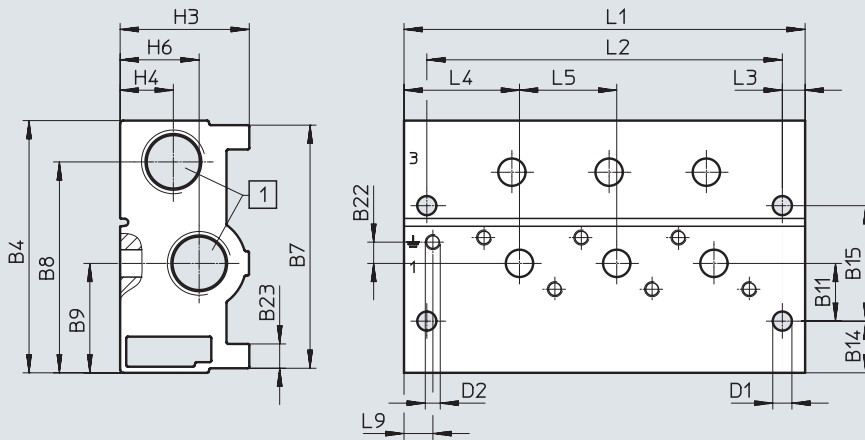

[1] Ports 1 and 3: 1/2 NPT

Type	B4	B7	B8	B9	B11	B14	B15	B22	B23
VABM-B10-30S-N12-...-P3	83	80	69.4	36	19	17	38	7	8

Type	D1 $\varnothing$	D2	H3	H4	H6	L3	L4	L5	L9
VABM-B10-30S-N12-...-P3	6.3	M5x11	42.5	17.5	26	7.5	38	32	12

Valve positions	2	3	4	5	6	7	8	9	10
L1 [mm]	100	132	164	196	228	260	292	324	356
L2 [mm]	85	117	149	181	213	245	277	309	341

## Dimensions

Manifold block for 5/2- and 5/3-way valves, compact

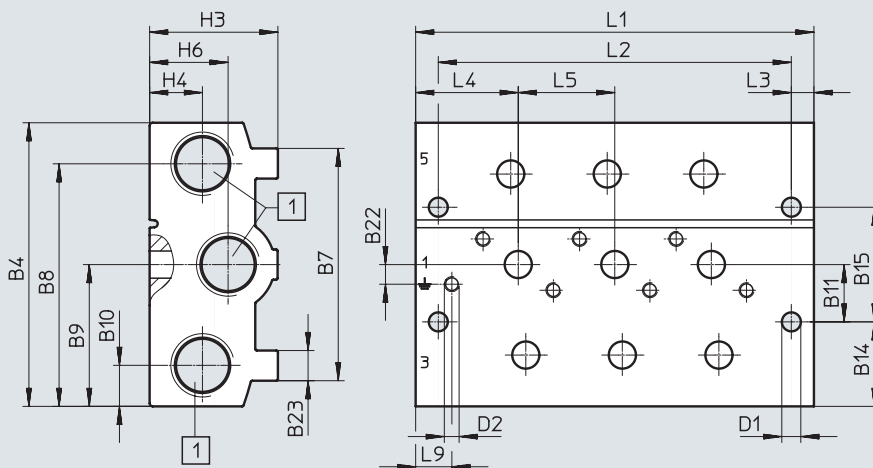

[1] Ports 1, 3 and 5: 1/2 NPT

Type	B4	B7	B8	B9	B10	B11	B14	B15	B22	B23
VABM-B10-30S-N12-...	94	77	80.4	47	13.6	19	28	38	6.5	10

Type	D1 $\varnothing$	D2	H3	H4	H6	L3	L4	L5	L9
VABM-B10-30S-N12-...	6.3	M5x11	42.5	17.5	26	7.5	34	32	12

Valve positions	2	3	4	5	6	7	8	9	10
L1 [mm]	100	132	164	196	228	260	292	324	356
L2 [mm]	85	117	149	181	213	245	277	309	341

## Datasheet – Manifold block, size 30

### Dimensions

Common supply manifold, for mounting on both sides

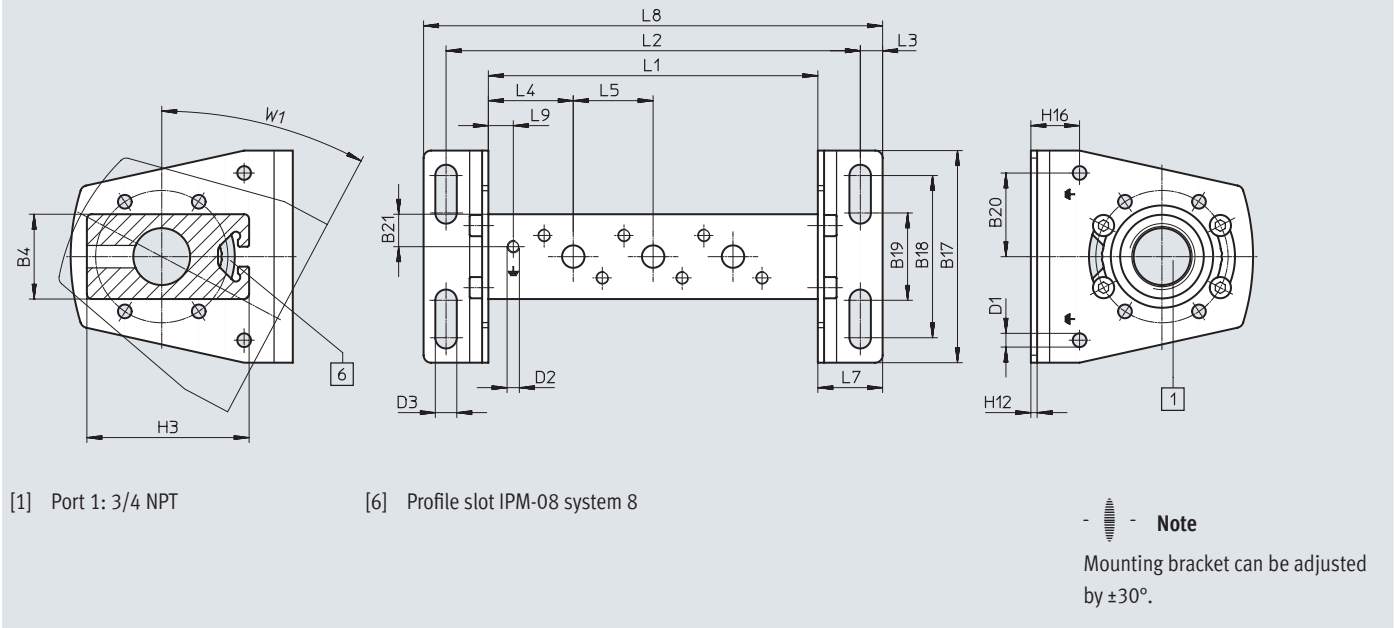









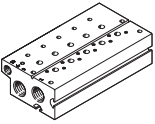

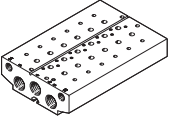
Type	B4	B17	B18	B19	B20	B21	D1 $\varnothing$	D2	D3 $\varnothing$	H3	H12	H16	L3	L4	L5	L7	L9	W1
VABM-B10-30-N34-...-P53	34	85	65	35	33.5	13	5.5	M5x11	8.6	65	2.5	19.5	9	34	32	26	10	30°

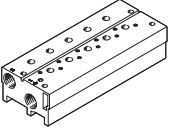

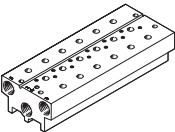

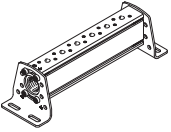



Valve positions	2	3	4	5	6	7	8	9	10
L1 [mm]	100	132	164	196	228	260	292	324	356
L2 [mm]	134	166	198	230	262	294	326	358	390
L8 [mm]	152	184	216	248	280	312	344	376	408

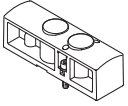
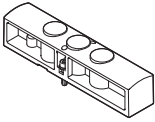

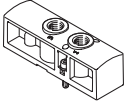

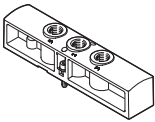

## Ordering data – Manifold block, size 30

Ordering data – Manifold block		Valve positions	Part no.	Type
<b>Standard manifold block</b>				
 <p>For 3/2-way valves, incl. seals and screws for valve assembly</p> <p>-  - <b>Note</b> Blanking plugs for sealing the supply ports (1, 3 and 14) at one end are included in the scope of delivery.</p>		2	8026404	VABM-B10-30E-N34-2-P3
		3	8026405	VABM-B10-30E-N34-3-P3
		4	8026406	VABM-B10-30E-N34-4-P3
		5	8026407	VABM-B10-30E-N34-5-P3
		6	8026408	VABM-B10-30E-N34-6-P3
		7	8026409	VABM-B10-30E-N34-7-P3
		8	8026410	VABM-B10-30E-N34-8-P3
		9	8026411	VABM-B10-30E-N34-9-P3
		10	8026412	VABM-B10-30E-N34-10-P3
	 <p>For 5/2-way and 5/3-way valves, incl. seals and screws for valve assembly</p> <p>-  - <b>Note</b> Blanking plugs for sealing the supply ports (1, 3, 5, 12 and 14) at one end are included in the scope of delivery.</p>		2	8026368
		3	8026369	VABM-B10-30E-N34-3
		4	8026370	VABM-B10-30E-N34-4
		5	8026371	VABM-B10-30E-N34-5
		6	8026372	VABM-B10-30E-N34-6
		7	8026373	VABM-B10-30E-N34-7
		8	8026374	VABM-B10-30E-N34-8
		9	8026375	VABM-B10-30E-N34-9
		10	8026376	VABM-B10-30E-N34-10
<b>Compact manifold block</b>				
 <p>For 3/2-way valves, incl. seals and screws for valve assembly</p> <p>-  - <b>Note</b> Blanking plugs for sealing the supply ports (1 and 3) at one end are included in the scope of delivery.</p>		2	8026422	VABM-B10-30S-N12-2-P3
		3	8026423	VABM-B10-30S-N12-3-P3
		4	8026424	VABM-B10-30S-N12-4-P3
		5	8026425	VABM-B10-30S-N12-5-P3
		6	8026426	VABM-B10-30S-N12-6-P3
		7	8026427	VABM-B10-30S-N12-7-P3
		8	8026428	VABM-B10-30S-N12-8-P3
		9	8026429	VABM-B10-30S-N12-9-P3
		10	8026430	VABM-B10-30S-N12-10-P3
	 <p>For 5/2-way and 5/3-way valves, incl. seals and screws for valve assembly</p> <p>-  - <b>Note</b> Blanking plugs for sealing the supply ports (1, 3 and 5) at one end are included in the scope of delivery.</p>		2	8026386
		3	8026387	VABM-B10-30S-N12-3
		4	8026388	VABM-B10-30S-N12-4
		5	8026389	VABM-B10-30S-N12-5
		6	8026390	VABM-B10-30S-N12-6
		7	8026391	VABM-B10-30S-N12-7
		8	8026392	VABM-B10-30S-N12-8
		9	8026393	VABM-B10-30S-N12-9
		10	8026394	VABM-B10-30S-N12-10
<b>Common supply manifold</b>				
 <p>For mounting on both sides, incl. seals and screws for valve assembly</p> <p>-  - <b>Note</b> Blanking plug for sealing the supply port (1) at one end included in the scope of delivery.</p>		2	8026347	VABM-B10-30-N34-2-P53
		3	8026348	VABM-B10-30-N34-3-P53
		4	8026349	VABM-B10-30-N34-4-P53
		5	8026350	VABM-B10-30-N34-5-P53
		6	8026351	VABM-B10-30-N34-6-P53
		7	8026352	VABM-B10-30-N34-7-P53
		8	8026353	VABM-B10-30-N34-8-P53
		9	8026354	VABM-B10-30-N34-9-P53
		10	8026355	VABM-B10-30-N34-10-P53







## Accessories – Manifold block, size 30

Ordering data				
Description		Weight [g]	Part no.	Type
<b>Cover plate</b>				
	For valve position on manifold block for 3/2-way valves	128	8026336	VABB-B10-30-E-P3
	For valve position on manifold block for 5/2-way, 5/3-way valves	179	8026335	VABB-B10-30-E
	For valve position on common supply manifold	43	8026334	VABB-B10-30-A
<b>Supply plate</b>				
	For valve position on manifold block for 3/2-way valves -  - <b>Note</b> Supply plates and air supply plates are only available with G thread.	121	8026435	VABF-B10-30-P1A4-G38-P3
	For valve position on manifold block for 5/2-way, 5/3-way valves -  - <b>Note</b> Supply plates and air supply plates are only available with G thread.	167	8026434	VABF-B10-30-P1A4-G38
<b>Air supply plate</b>				
	For valve position on common supply manifold -  - <b>Note</b> Supply plates and air supply plates are only available with G thread.	40	8026433	VABF-B10-30-P1-G38

## Accessories – Manifold block, size 30

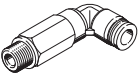

Ordering data		Description of NPT thread	Part no.	Type	PU <sup>1)</sup>
<b>Push-in fitting with internal hex</b>					
	Connecting thread 1/8 NPT for tubing O.D.	1/4 "	572318	QB-1/8-1/4-I-U	10
	Connecting thread 1/2 NPT for tubing O.D.	1/2 "	572326	QB-1/2-1/2-I-U	10
<b>Push-in fitting with external hex</b>					
	Connecting thread 1/2 NPT for tubing O.D.	3/8 "	533283	QB-1/2-3/8-U	5
<b>Angled push-in fitting, with external hex</b>					
	Connecting thread 1/2 NPT for tubing O.D.	3/8 "	533302	QBL-1/2-3/8-U	5
		1/2 "	533303	QBL-1/2-1/2-U	5
<b>Barbed fitting with external hex</b>					
	Connecting thread 3/4 NPT for tubing I.D. Aluminium version	19 mm	564848	N-3/4-P-19-NPT	1

1) Packaging unit

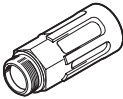

Ordering data		Description of G thread	Part no.	Type	PU <sup>1)</sup>
<b>Push-in fitting with internal hex</b>					
	Connecting thread G3/8 for tubing O.D.  -  - <b>Note</b> Push-in fittings with G thread are for supply plates and air supply plates only.	8 mm	186111	QS-G3/8-8-I	10
		10 mm	186113	QS-G3/8-10-I	10
		12 mm	186114	QS-G3/8-12-I	10
<b>Angled push-in fitting, with external hex</b>					
	Connecting thread G3/8 for tubing O.D.  -  - <b>Note</b> Push-in fittings with G thread are for supply plates and air supply plates only.	8 mm	186121	QSL-G3/8-8	10
			132055	QSL-G3/8-8-50	50
		10 mm	186123	QSL-G3/8-10	10
			132056	QSL-G3/8-10-20	20
		12 mm	186124	QSL-G3/8-12	10
	132057	QSL-G3/8-12-20	20		
<b>Angled push-in fitting, long, with external hex</b>					
	Connecting thread G3/8 for tubing O.D.  -  - <b>Note</b> Push-in fittings with G thread are for supply plates and air supply plates only.	8 mm	186132	QSL-G3/8-8	10
		10 mm	186134	QSL-G3/8-10	10
		12 mm	186135	QSL-G3/8-12	10

1) Packaging unit



Accessories – Manifold block, size 30

Ordering data		Description of NPT thread	Part no.	Type	PU <sup>1)</sup>
<b>Silencer</b>					
	With connecting thread NPT, metal design	3/8 NPT	12740	U-3/8-B-NPT	1
		1/2 NPT	12741	U-1/2-B-NPT	1
		3/4 NPT	566823	U-3/4-B-NPT	1
	With connecting thread NPT, sintered design, long	1/2 NPT	1206992	AMTE-M-LH-N12	10

1) Packaging unit

Ordering data		Description of G thread	Part no.	Type	PU <sup>1)</sup>
<b>Silencer</b>					
	With connecting thread G, metal version	G3/8	6843	U-3/8-B	1
	With connecting thread G, sintered version, long	3/8 NPT	1206991	AMTE-M-LH-N38	20

1) Packaging unit

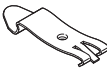
Ordering data		Description	Part no.	Type	PU <sup>1)</sup>
<b>Blanking plug</b>					
	With connecting thread NPT	1/8 NPT	173985	B-1/8-NPT	1
		1/2 NPT	31785	B-1/2-NPT	1
		3/4 NPT	31786	B-3/4-NPT	1
<b>Separator</b>					
	For creating pressure zones	G1/8	569995	VABD-8-B	1
		1/8 NPT			
		G1/2	8022483	VABD-17.5-B	1
		1/2 NPT			
G3/4	8022484	VABD-22.7-B	1		
3/4 NPT					
<b>DIN rail mounting</b>					
	For size 30, for mounting on standard TH 357.5 or TH 3515 DIN rails to EN 60715		3488412	VAME-T-M6	2

1) Packaging unit