

Three-point gripper HGDD

FESTO



Characteristics

At a glance

[Link](#) [hgdd](#)

The fully encapsulated gripper kinematics enable the gripper to be used in extremely harsh ambient conditions.

Sturdy and precise kinematics for maximum torque resistance and long service life.

The force generated by the linear motion is transferred into the gripper jaw movement via a wedge mechanism with force-guided motion. This also ensures that the gripper jaws move synchronously. The plain-bearing guide is virtually backlash-free thanks to the ground-in gripper jaws.

Flexible range of applications:

- Can be used as a double-acting and single-acting gripper
- Compression spring for supporting or retaining the gripping forces
- Suitable for external and internal gripping

These grippers are not designed for the following or similar application examples:

- Welding spatter

These grippers are of limited suitability for the following application examples:

- Aggressive media: only possible after consultation with Festo
- Grinding dust

Compressed air connections for harsh ambient conditions:

- When using the gripper in humid environments or when using liquid/gaseous media, make sure that the filter is installed in a neutral environment. The same applies to compressed air connections that are not required when using the gripper as a single-acting gripper.

Engineering tools

[Link](#) [engineering tools](#)



Save time with engineering tools Smart Engineering for the optimal solution. Our goal is to increase your productivity. Our engineering tools play an integral part in this. They help you size your system correctly, tap into unimagined productivity reserves and generate additional productivity along the entire value chain. In every phase of your project, from the initial contact to the modernisation of your machine, you will come across a number of different tools which will be of use to you.

Gripper selection:

- This tool helps you to select the right grippers by simply entering the exact parameters for your application

Diagrams

[Link](#) [hgdd](#)



The diagrams shown in this document are also available online. These can be used to display precise values.

Position sensing

[A] For proximity sensor

By using proximity switches, any position can be detected.

Gripping force backup

[G1] Opening



Opened by spring force in depressurised state

[G2] N/O contact



Closed by spring force in depressurised state

Type code

001	Series
HGDD	Three-point gripper, sealed

002	Size [mm]
35	35
40	40
50	50
63	63
80	80

003	Position sensing
A	For proximity sensor

004	Gripping force backup
	None
G1	Opening
G2	N/O contact

Datasheet

General technical data					
Size	35	40	50	63	80
Stroke per gripper jaws	4 mm	6 mm	8 mm	10 mm	12 mm
Design	Wedge-shaped drive Force pilot operated motion sequence				
Mode of operation	Double-acting				
Gripping force backup	None N/O contact Opening				
Gripper function	3-point				
Number of gripper jaws	3				
Max. mass per external gripper finger ¹⁾	57 g	130 g	276 g	440 g	790 g
Pneumatic connection	M5		G1/8		
Pneumatic connection, blocked air	M3		M5		G1/8
Repetition accuracy, gripper ²⁾	≤0.03 mm			≤0.05 mm	
Max. replacement accuracy	≤0.2 mm				
Max. operating frequency of gripper	≤4 Hz				
Rotationally symmetrical	≤0.2 mm				
Position detection	Via proximity switch				
Type of mounting	Either: Via through-hole and dowel pin Via female thread and dowel pin				
Mounting position	optional				

1) Applies to unthrottled operation

2) Under constant exposure to operating conditions, end-position drift occurs concentrically to the central axis, at 100 consecutive strokes

Operating and environmental conditions					
Size	35	40	50	63	80
Operating medium	Compressed air to ISO 8573-1:2010 [7:4:4]				
Note on operating and pilot medium	Lubricated operation possible (in which case lubricated operation will always be required)				
Ambient temperature ¹⁾	5 ... 60°C				
Degree of protection	IP65				
Corrosion resistance class CRC ²⁾	2 - Moderate corrosion stress				
Lubrication interval for guide components	5 MioCyc				

1) Note the operating range of the proximity switches

2) More information: www.festo.com/x/topic/crc

Operating pressure – HGDD-35 ... 50										
Size	35			40			50			
Gripping force backup	None	N/O contact	Opening	None	N/O contact	Opening	None	N/O contact	Opening	
Operating pressure	3 ... 8 bar		4 ... 8 bar		3 ... 8 bar		4 ... 8 bar		3 ... 8 bar	
Operating pressure of blocked air	0 ... 0.5 bar									

Operating pressure – HGDD-63 ... 80						
Size	63			80		
Gripping force backup	None	N/O contact	Opening	None	N/O contact	Opening
Operating pressure	3 ... 8 bar		4 ... 8 bar		3 ... 8 bar	
Operating pressure of blocked air	0 ... 0.5 bar					

Weight – HGDD-35 ... 50										
Size	35			40			50			
Gripping force backup	None	N/O contact	Opening	None	N/O contact	Opening	None	N/O contact	Opening	
Product weight	309 g		370 g		599 g		775 g		1,117 g	
									1,495 g	

Datasheet

Weight – HGDD-63 ... 80

Size	63			80		
Gripping force backup	None	N/O contact	Opening	None	N/O contact	Opening
Product weight	2,175 g	2,848 g		3,522 g	4,788 g	

Materials

Size	35	40	50	63	80
Material housing	Smooth-anodised wrought aluminium alloy				
Material gripper jaws	Hardened steel				
Material cover cap	High-alloy stainless steel				
Note on materials	RoHS-compliant				
LABS (PWIS) conformity	VDMA24364-B2-L				

Gripping force

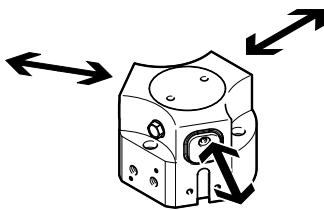

Size	35	40	50	63	80
Total gripping force, closing, 0.6MPa (6bar, 87 psi)	336 N	600 N	1,044 N	1,659 N	2,745 N
Total gripping force, opening, 0.6MPa (6bar, 87 psi)	366 N	648 N	1,113 N	1,746 N	2,829 N
Gripper force per gripper jaw, closing, 0.6 MPa (6 bar, 87 psi)	112 N	200 N	348 N	553 N	915 N
Gripper force per gripper jaw, opening, 0.6 MPa (6 bar, 87 psi)	122 N	216 N	371 N	582 N	943 N

Characteristic load values at the gripper jaws

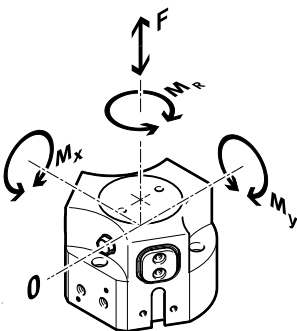

The indicated permissible forces and torques apply to a single gripper jaw. They include the lever arm, additional applied loads created by the workpiece or external gripper fingers and acceleration forces occurring during movement. The zero coordinate line (gripper jaw guide) must be taken into account when calculating torques.

Size	35	40	50	63	80
Max. force on gripper jaw Fz static	300 N	700 N	1,300 N	2,300 N	3,600 N
Max. torque at gripper Mx static	12 Nm	25 Nm	45 Nm	70 Nm	100 Nm
Max. torque at gripper My static	8 Nm	18 Nm	30 Nm	45 Nm	65 Nm
Max. torque at gripper Mz static	8 Nm	20 Nm	30 Nm	50 Nm	75 Nm

Datasheet

Gripping force FH per gripper jaw as a function of operating pressure and lever arm x

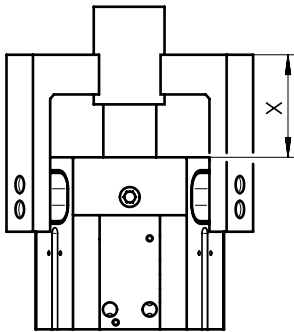

The gripping forces as a function of operating pressure and lever arm can be determined from the following graphs.

The gripping torque is not constant across the opening angle.

Sizing software for gripper selection → <https://www.festo.com/x/topic/eng>

Gripping force FH per gripper jaw as a function of operating pressure and lever arm x – external gripping (closing), double-acting – HGDD-35

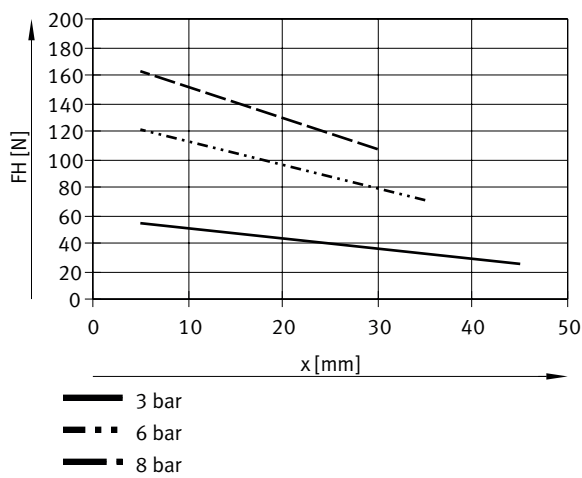

Gripping force FH per gripper jaw as a function of operating pressure and lever arm x – external gripping (closing), double-acting – HGDD-40

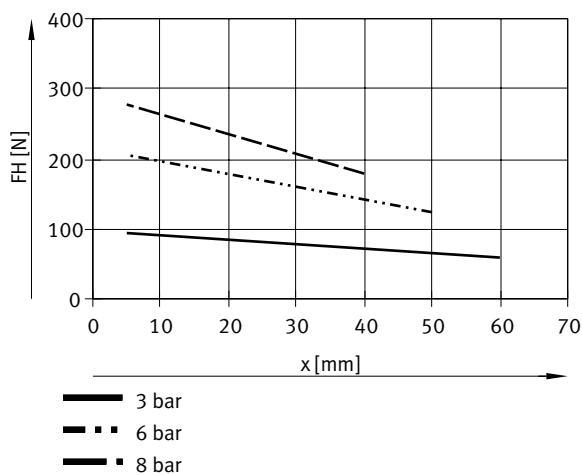

Datasheet

Gripping force FH per gripper jaw as a function of operating pressure and lever arm x – external gripping (closing), double-acting – HGDD-50

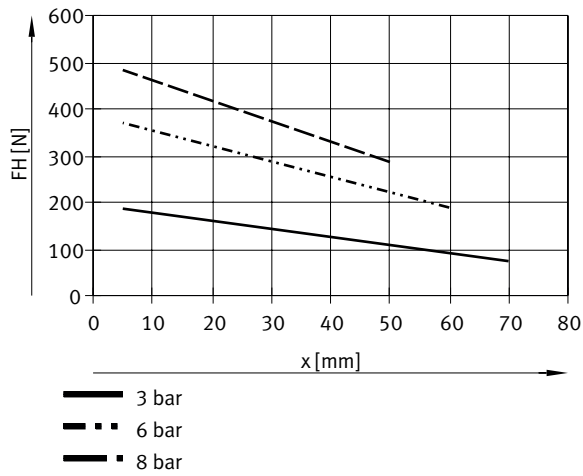

Gripping force FH per gripper jaw as a function of operating pressure and lever arm x – external gripping (closing), double-acting – HGDD-63

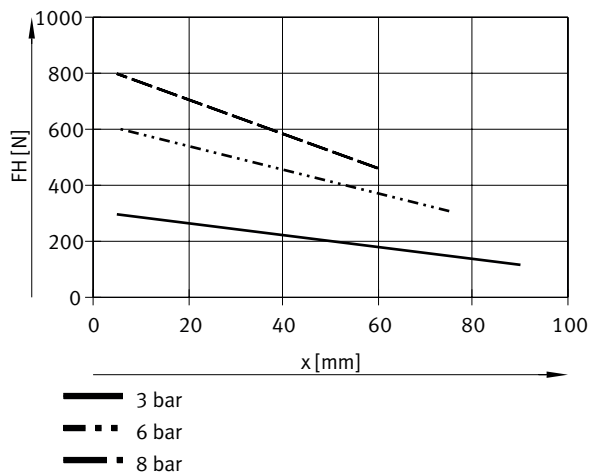

Gripping force FH per gripper jaw as a function of operating pressure and lever arm x – external gripping (closing), double-acting – HGDD-80

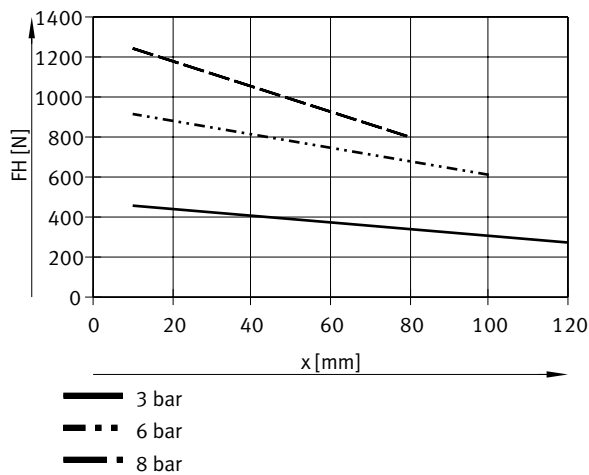

Datasheet

Gripping force FH per gripper jaw as a function of operating pressure and lever arm x – internal gripping (opening), double-acting – HGDD-35

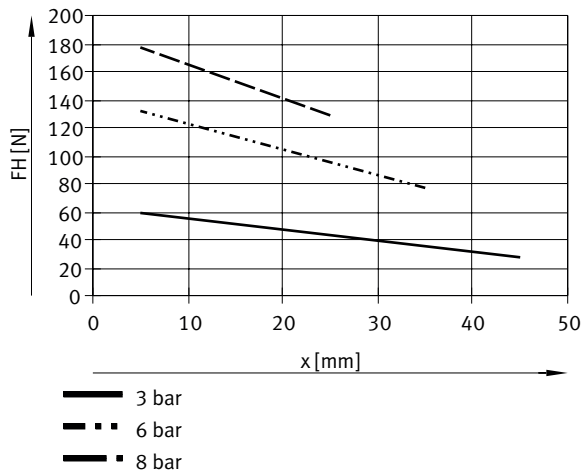

Gripping force FH per gripper jaw as a function of operating pressure and lever arm x – internal gripping (opening), double-acting – HGDD-40

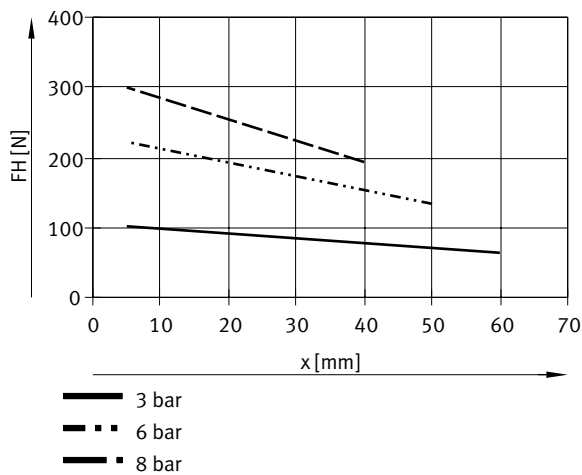

Gripping force FH per gripper jaw as a function of operating pressure and lever arm x – internal gripping (opening), double-acting – HGDD-50

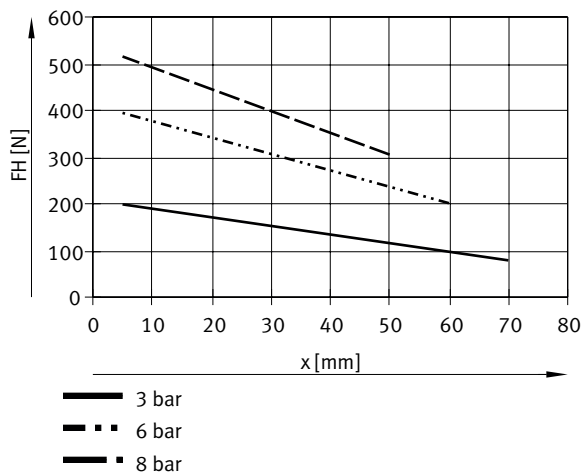

Datasheet

Gripping force F_H per gripper jaw as a function of operating pressure and lever arm x – internal gripping (opening), double-acting – HGDD-63

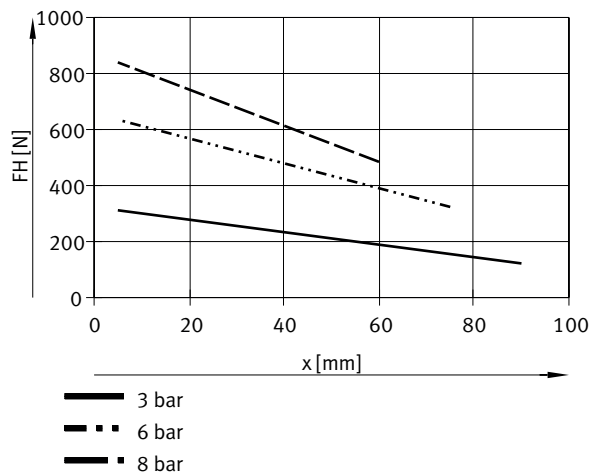

Gripping force F_H per gripper jaw as a function of operating pressure and lever arm x – internal gripping (opening), double-acting – HGDD-80

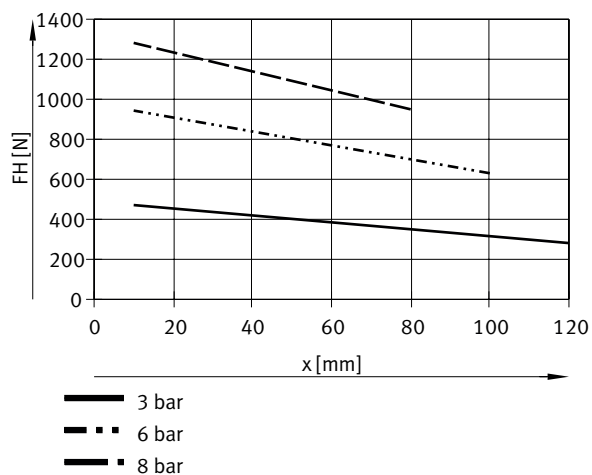

Spring force F_F as a function of size and gripper jaw stroke l per gripper finger – with gripping force backup

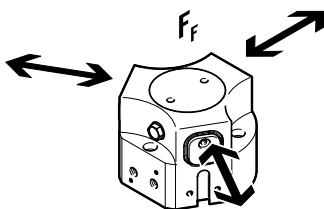

The spring forces F_F can be determined from the following graphs as a function of the gripper jaw stroke.

Datasheet

Spring force FF as a function of size and gripper jaw stroke l per gripper finger – with gripping force backup – HGDD-35 ... 50-...-G...

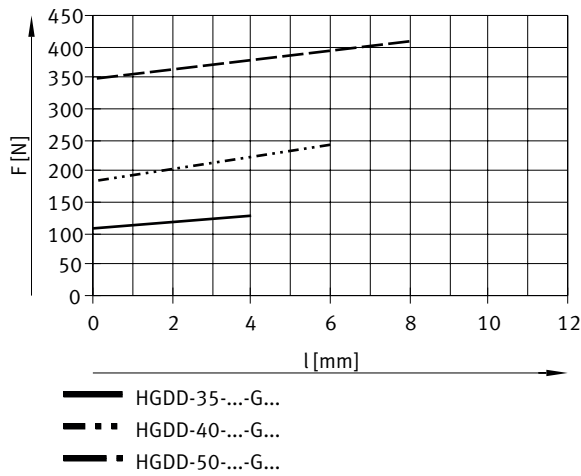

Spring force FF as a function of size and gripper jaw stroke l per gripper finger – with gripping force backup – HGDD-63 ... 80-...-G...

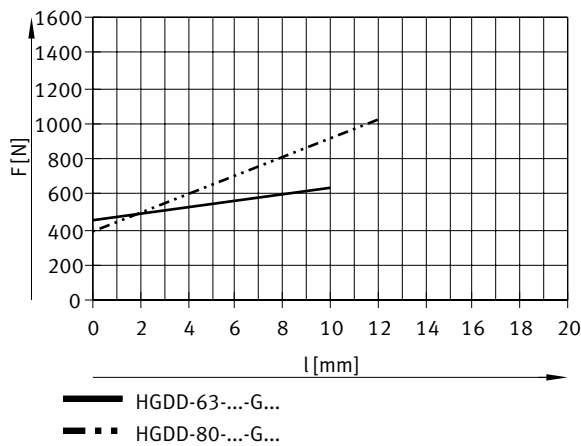

Spring force FF as a function of size, gripper jaw stroke l and lever arm x per gripper finger

To determine the actual spring force F_{tot}, the lever arm x must be taken into account.

Formulas for calculating the spring force F_{tot} per gripper finger:

- HGDD-35-...-G1: $-0.85 * x + 0.45 * FF$
- HGDD-40-...-G1: $-0.55 * x + 0.35 * FF$
- HGDD-50-...-G1: $-2.5 * x + 0.75 * FF$
- HGDD-63-...-G1: $-0.2 * x + 0.4 * FF$
- HGDD-80-...-G1: $-1.5 * x + 0.35 * FF$

- HGDD-35-...-G2: $-0.6 * x + 0.45 * FF$
- HGDD-40-...-G2: $-0.55 * x + 0.35 * FF$
- HGDD-50-...-G2: $-2.5 * x + 0.6 * FF$
- HGDD-63-...-G2: $-1.0 * x + 0.4 * FF$
- HGDD-80-...-G2: $-4.0 * x + 0.85 * FF$

Datasheet

Determining the actual gripping forces F_{Gr} per gripper finger for HGDD-...-G1 and HGDD-...-G2 as a function of application

The grippers with integrated spring, type HGDD-...-G1 (opening gripping force backup) and HGDD-...-G2 (closing gripping force backup) can be used as:

- Single-acting grippers
- Gripper with gripping force support and
- Grippers with gripping force backup depending on requirements.

To calculate available gripping forces F_{Gr} (per gripper finger), the data for gripping force F_H and spring force F_{Ftot} must be combined accordingly.

Determining the actual gripping forces F_{Gr} per gripper finger for HGDD-...-G1 and HGDD-...-G2 as a function of application – application

Single-acting:

- Gripping with spring force: $F_{Gr} = F_{Ftot}$
- Gripping with pressure force: $F_{Gr} = F_H - F_{Ftot}$

Gripping force support:

- Gripping with pressure and spring force: $F_{Gr} = F_H + F_{Ftot}$

Gripping force backup

- Gripping with spring force: $F_{Gr} = F_{Ftot}$

Mass moments of inertia – HGDD-35 ... 50

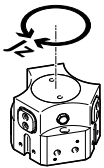

Mass moment of inertia of the gripper in relation to the central axis, without external gripper fingers, with no load.

Size	35			40			50		
Gripping force backup	None	N/O contact	Opening	None	N/O contact	Opening	None	N/O contact	Opening
Mass moment of inertia	1.01 kgcm ²	1.37 kgcm ²		3.331 kgcm ²	5.01 kgcm ²		9.65 kgcm ²	15.07 kgcm ²	

Mass moments of inertia – HGDD-63 ... 80

Size	63			80		
Gripping force backup	None	N/O contact	Opening	None	N/O contact	Opening
Mass moment of inertia	29 kgcm ²	45.05 kgcm ²		70.22 kgcm ²	109 kgcm ²	

Gripper jaw backlash

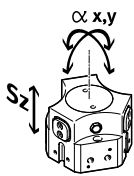

The plain-bearing guide used in the grippers means that there is backlash between the gripper jaws and the housing. The values listed in the table apply in new condition. The backlash values listed in the table have been calculated based on the traditional accumulative tolerance method.

Size	35	40	50	63	80
Max. gripper jaw backlash S_z	0.05 mm				
Max. angular gripper jaw backlash α_x, α_y	0.1 deg				

Datasheet

Opening and closing times – HGDD-35 ... 50

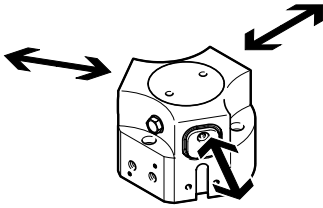

The indicated opening and closing times [ms] were measured at room temperature, 0.6 MPa (6 bar, 87 psi) operating pressure and with the gripper installed horizontally without additional gripper fingers. The grippers must be throttled for higher masses [g]. Opening and closing times must then be adjusted accordingly.

Size	35			40			50		
Gripping force backup	None	N/O contact	Opening	None	N/O contact	Opening	None	N/O contact	Opening
Min. closing time at 0.6 MPa (6 bar, 87 psi)	52 ms	42 ms	85 ms	106 ms	110 ms	211 ms	128 ms	87 ms	160 ms
Min. opening time at 0.6 MPa (6 bar, 87 psi)	44 ms	81 ms	38 ms	78 ms	144 ms	70 ms	93 ms	111 ms	25 ms

Opening and closing times – HGDD-63 ... 80

Size	63			80		
Gripping force backup	None	N/O contact	Opening	None	N/O contact	Opening
Min. closing time at 0.6 MPa (6 bar, 87 psi)	145 ms	68 ms	190 ms	142 ms	107 ms	246 ms
Min. opening time at 0.6 MPa (6 bar, 87 psi)	115 ms	135 ms	48 ms	152 ms	159 ms	72 ms

Dimensions

Dimensions – Three-point gripper HGDD

Download CAD data www.festo.com

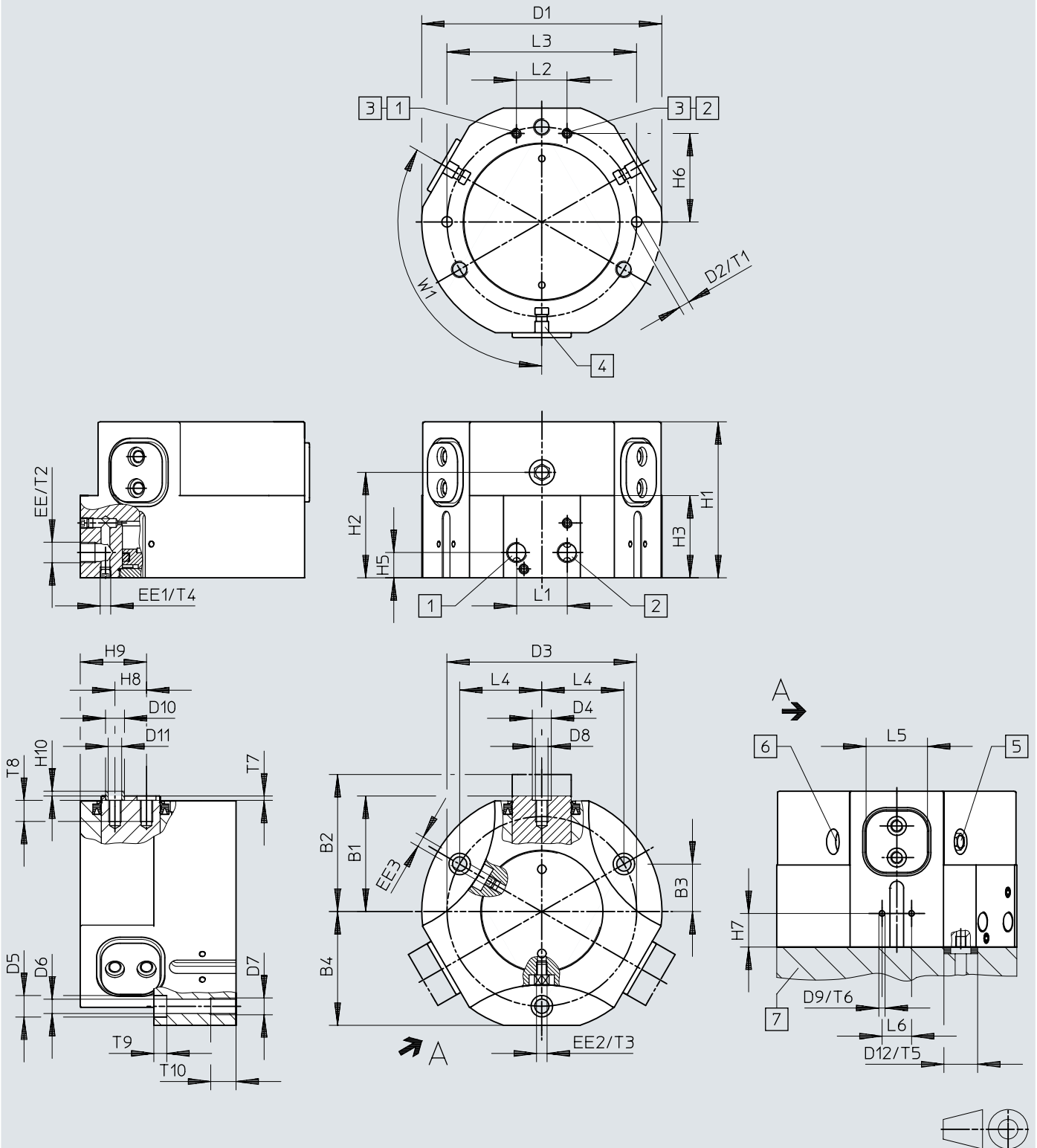

- [1] Open compressed air supply port
- [2] Close compressed air supply port
- [3] Alternative air supply port (sealed on delivery)
- [4] T-slot for proximity switch
- [5] Exhaust hole (integrated filter)
- [6] Lubrication nipple (sealed on delivery)
- [7] O-ring for HGDD-35: 3x1.5 / HGDD-40 ... 80: 5x1.5

Dimensions

	B1 ±0,5	B2 ±0,5	B3	B4	D1 ∅ ±0,1	D2 ∅ H8	D3 ∅ ±0,1	D4 ∅ H8	D5 ∅ H13	D6 ∅ H13	D7	D8	D9
HGDD-35	28	32	11	22	58	3	44	5	5,9	3,3	M4	M3	M3
HGDD-40	36	42	14	28	74	4	56	7	9,4	5,1	M6	M4	M3
HGDD-50	44,5	52,5	17,5	35	93	5	70	9	10,2	6,8	M8	M6	M3
HGDD-63	55	65	22,5	45	114	5	90	9	10,2	6,8	M8	M6	M3
HGDD-80	68	80	28	56	139	6	112	9	13,5	8,4	M10	M6	M3

	D10 ∅ h7	D11 ∅	D12 ∅ +0,2	EE	EE1	EE2	EE3	H1		H2	
								±0,05	-G ±0,05		-G
HGDD-35	5	3,2	6	M5	M3	M3	M3	41	51	29	39
HGDD-40	7	5,3	8	M5	M5	M3	M3	48,5	66	34,5	52
HGDD-50	9	6,4	8	G1/8	M5	M5	M5	58,5	83,5	40,4	65,4
HGDD-63	9	6,4	8	G1/8	M5	M5	M5	74	104	50	80
HGDD-80	9	6,4	8	G1/8	M5	G1/8	M5	83,5	120,5	55,5	92,5

	H3		H5	H6	H7		H8 ¹⁾	H9	H10	L1	L2	L3	L4
	-0,2	-G -0,2	±0,1	±0,1	±0,1	-G ±0,1		-0,02	-0,3	±0,1	±0,1	±0,02	
HGDD-35	23	33	9	18,5	7	17	7	15,5	1,2	12	15	45	19,05
HGDD-40	27,5	45	9	25	10	27,5	10	19	1,4	12	18	56	24,25
HGDD-50	32,5	57,5	12	32	12,5	37,5	12	24,1	1,9	24	18	70	30,31
HGDD-63	39	69	12	42	16	46	15	31,5	1,9	24	24	90	38,97
HGDD-80	43	80	12	53	21	58	18	37	1,9	30	30	112	48,5

	L5	L6	T1	T2	T3	T4	T5	T6	T7	T8	T9	T10	W1
	-0,02	±0,1	min.	min.	min.	min.	+0,1	min.	+0,1	min.	+0,2	min.	
HGDD-35	14	12	5	5	3	3	1,2	4	1,3	5	3,2	8	120°
HGDD-40	18	12	6	6	3	5	1,2	5	1,6	6	5	10	120°
HGDD-50	22	12	8	7	6	5	1,2	5	2,1	10	6,1	12	120°
HGDD-63	28	14	8	7	6	5	1,2	5	2,1	10	6,1	12	120°
HGDD-80	32	14	10	8	10	5	1,2	5	2,1	10	8	15	120°

1) Tolerance for centring hole ±0.02 mm Tolerance for thread ±0.1 mm

Dimensions

Dimensions – Gripper jaw blank BUB-HGDD

Download CAD data www.festo.com

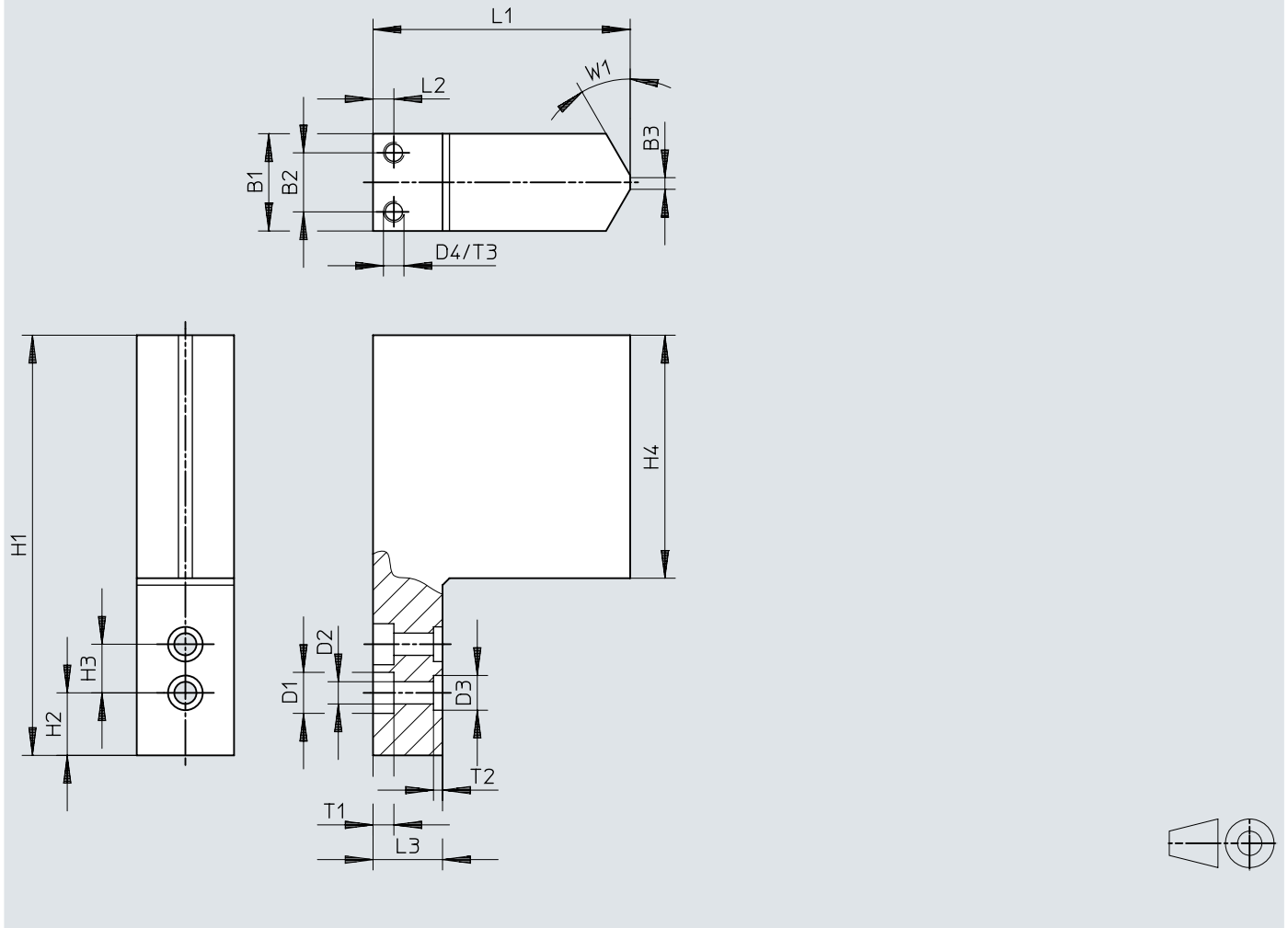

	B1 ±0,05	B2	B3	D1 ∅ H13	D2 ∅ H13	D3 ∅ H8	D4	H1 ±0,05	H2 ±0,02
BUB-HGDD-35	14	8,5	2	5,9	3,2	5	M3	60,5	9
BUB-HGDD-40	20	14	2	7,4	4,3	7	M3	77	7
BUB-HGDD-50	29	23	2	10,4	6,4	9	M3	96	11
BUB-HGDD-63	32	26	2	10,4	6,4	9	M3	121	13,5
BUB-HGDD-80	35	26	2	10,4	6,4	9	M3	153,5	15,5

	H3 ¹⁾	H4	L1 ±0,05	L2	L3	T1	T2 +0,1	T3	W1
BUB-HGDD-35	7	35	37	3	10	3 ^{+0,2}	1,3	5	30°
BUB-HGDD-40	10	50	45	5	10	4 ^{+0,2}	1,6	5	30°
BUB-HGDD-50	12	60	55	6	12	6,1 ^{+0,1}	2,1	5	30°
BUB-HGDD-63	15	75	64	6	12	6,1 ^{+0,1}	2,1	5	30°
BUB-HGDD-80	18	100	79,4	10	15	6,1 ^{+0,1}	2,1	5	30°

1) ±0.02 and ±0.01 apply to the centring hole D3 / ±0.1 applies to the through-holes D1 and D2

Dimensions

Dimensions – Sensor bracket DASI

Download CAD data www.festo.com

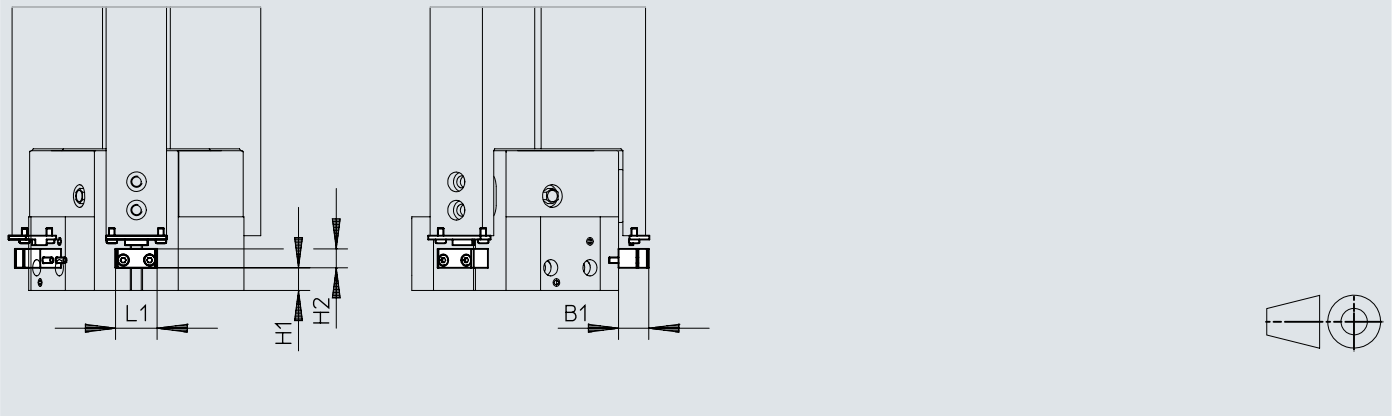

	B1	H1		H2	L1
			-G		
DASI-B13-35-S3	13	3	13	8	21
DASI-B13-40-S8	16	6	23,5	10	20
DASI-B13-50-S8	16	8,5	33,5	10	20
DASI-B13-63-S8	16	10	36	10	22
DASI-B13-80-S8	22	10	47	15	22

Ordering data

Double-acting, without compression spring					
	Size	Stroke per gripper jaws	Product weight	Part no.	Type
	35	4 mm	309 g	1163037	HGDD-35-A
	40	6 mm	599 g	1163040	HGDD-40-A
	50	8 mm	1,117 g	1163043	HGDD-50-A
	63	10 mm	2,175 g	1163046	HGDD-63-A
	80	12 mm	3,522 g	1163049	HGDD-80-A

Single-acting or with gripping force backup, opening					
	Size	Stroke per gripper jaws	Product weight	Part no.	Type
	35	4 mm	370 g	1163039	HGDD-35-A-G2
	40	6 mm	775 g	1163042	HGDD-40-A-G2
	50	8 mm	1,495 g	1163045	HGDD-50-A-G2
	63	10 mm	2,848 g	1163048	HGDD-63-A-G2
	80	12 mm	4,788 g	1163051	HGDD-80-A-G2

Single-acting or with gripping force backup, closing					
	Size	Stroke per gripper jaws	Product weight	Part no.	Type
	35	4 mm	370 g	1163038	HGDD-35-A-G1
	40	6 mm	775 g	1163041	HGDD-40-A-G1
	50	8 mm	1,495 g	1163044	HGDD-50-A-G1
	63	10 mm	2,848 g	1163047	HGDD-63-A-G1
	80	12 mm	4,788 g	1163050	HGDD-80-A-G1

Peripherals

Peripherals overview

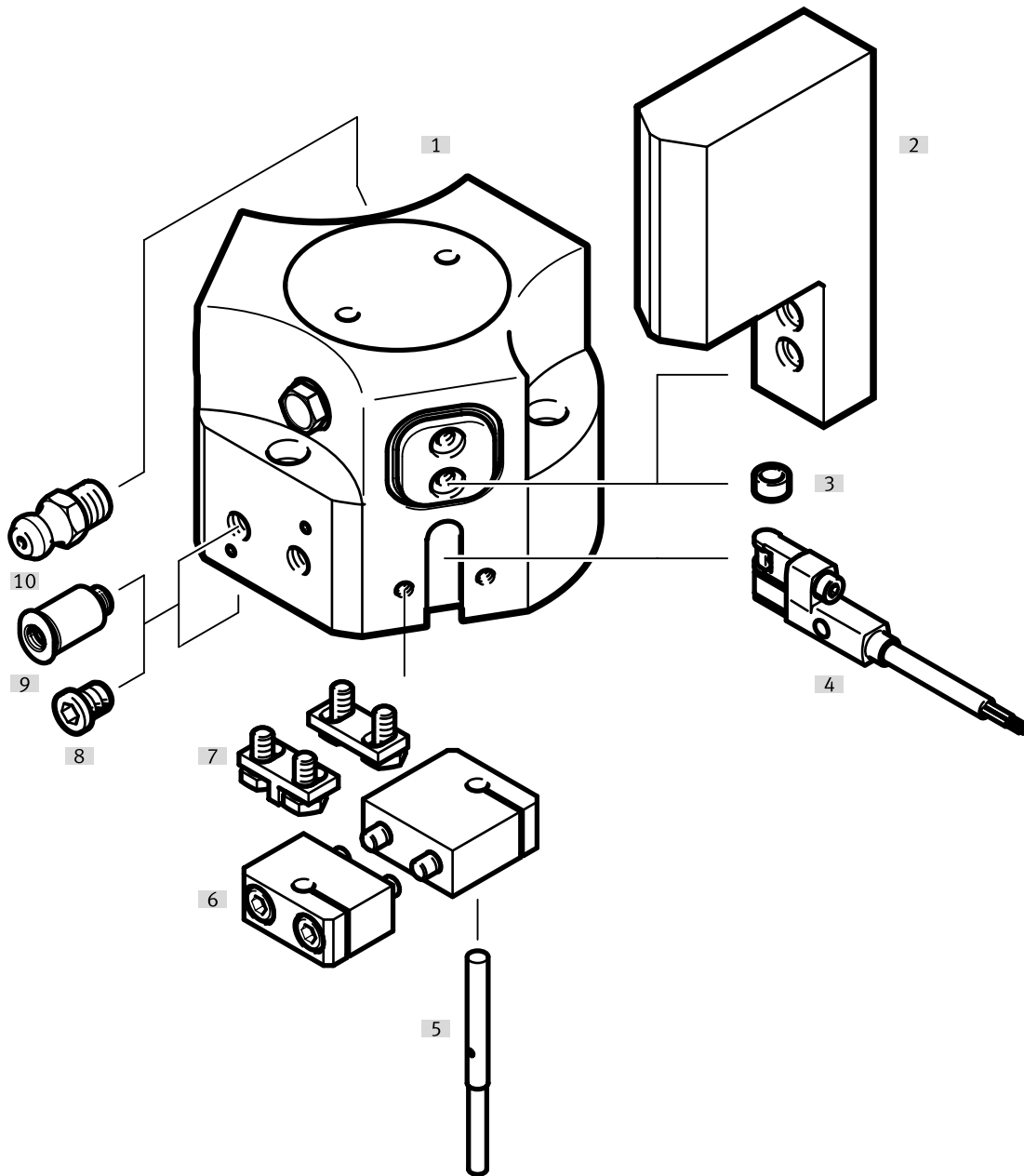

Accessories			→ Link
Type/order code	Description		
[1] Three-point gripper HGDD	Double-acting		hgdd
[2] Gripper jaw blank BUB-HGDD	Blanks specially matched to the gripper jaws for custom manufacturing of gripper fingers		19
[3] Centring sleeve ZBH	<ul style="list-style-type: none"> • For centring the gripper jaw blanks/gripper fingers on the gripper jaws • 6 centring sleeves included in the scope of delivery of the gripper 		19
[4] Proximity switch SMT-8G	<ul style="list-style-type: none"> • For sensing the piston position, 3 slots are available • Proximity switch does not project past the housing at the bottom 		20
[5] Proximity switch SIEH/SIEN	For sensing the piston position		20
[6] Sensor bracket DAS1	Clamping terminal for fixing the proximity switches SIEH or SIEN into place		19
[7] Sensor bracket DAS1	Switching lug for sensing the gripper jaw position. It is attached to the gripper jaw blank		19
[8] Blanking plug B	For sealing the compressed air ports when using the bottom compressed air ports		19
[9] Push-in fitting QS	For connecting tubing with standard O.D		qs
[10] Lubrication nipple	Included in the scope of delivery of the gripper		hgdd
[11] Adapter kit DHAA, HAPG	Connecting plate between drive and gripper		dhaa
[12] Proportional-pressure regulator VPPM	For infinitely variable adjustment of the gripping force		vppm

Accessories

Gripper jaw blank BUB-HGDD

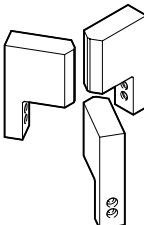
	Description	Material unmachined part	Product weight per gripper jaw	Part no.	Type
	For size 35	Wrought aluminium alloy	57 g	1180955	BUB-HGDD-35
	For size 40		131 g	1180956	BUB-HGDD-40
	For size 50		276 g	1180957	BUB-HGDD-50
	For size 63		440 g	1180958	BUB-HGDD-63
	For size 80		793 g	1180959	BUB-HGDD-80

Sensor bracket DASI

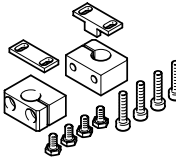
	Description	Note on materials	Product weight	Part no.	Type
	For size 35	RoHS-compliant	20 g	1435236	DASI-B13-35-S3
	For size 40		27 g	1435232	DASI-B13-40-S8
	For size 50		30 g	1435233	DASI-B13-50-S8
	For size 63		35 g	1435234	DASI-B13-63-S8
	For size 80		45 g	1435235	DASI-B13-80-S8

Centring sleeve ZBH-5

	Description	Material sleeve	Size of pack	Product weight	Part no.	Type
	For size 35	Steel	10	1 g	8146543	ZBH-5-B

Centring sleeve ZBH-7

	Description	Material sleeve	Size of pack	Product weight	Part no.	Type
	For size 40	Steel	10	1 g	8146544	ZBH-7-B

Centring sleeve ZBH-9

	Description	Material sleeve	Size of pack	Product weight	Part no.	Type
	For sizes 50, 63, 80	Steel	10	2 g	8137184	ZBH-9-B

Blanking plug B-M5-B

	Description	Material blanking plug	Size of pack	Product weight	Part no.	Type
	For sizes 35, 40	Galvanised steel	10	1 g	★ 174308	B-M5-B

Blanking plug B-1/8

	Description	Material blanking plug	Size of pack	Product weight	Part no.	Type
	For sizes 50, 63, 80	Galvanised steel	10	7 g	★ 3568	B-1/8

Accessories

Proximity switch SMT-8G for T-slot, magneto-resistive

[Link](#) [smt](#)

	Type of mounting	Switching output	Electrical connection	Cable length	Part no.	Type
	Clamped in T-slot, Insertable in the slot lengthwise	3-wire NPN N/O contact	Open end	2.5 m	8065028	SMT-8G-NS-24V-E-2,5Q-OE
			Plug M8, A-coded	0.3 m	8065027	SMT-8G-NS-24V-E-0,3Q-M8D
		3-wire PNP N/O contact	Open end	2.5 m	547859	SMT-8G-PS-24V-E-2,5Q-OE
			Plug M8, A-coded	0.3 m	547860	SMT-8G-PS-24V-E-0,3Q-M8D

Connecting cable NEBU, straight, connection M8

	Electrical connection 1, connector system	Electrical connection 2, connector system	Electrical connection 2, number of connections/cores	Cable length	Part no.	Type
	M8x1, A-coded, to EN 61076-2-104	Open end	3	2.5 m	541333	NEBU-M8G3-K-2.5-LE3
				5 m	541334	NEBU-M8G3-K-5-LE3

Connecting cable NEBU, angled, M8 connection

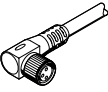
	Electrical connection 1, connector system	Electrical connection 2, connector system	Electrical connection 2, number of connections/cores	Cable length	Part no.	Type
	M8x1, A-coded, to EN 61076-2-104	Open end	3	2.5 m	541338	NEBU-M8W3-K-2.5-LE3
				5 m	541341	NEBU-M8W3-K-5-LE3

Proximity switch SIEH – 3 mm (round design), inductive – for size 35

[Link](#) [sieh](#)

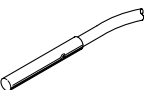
	Type of mounting	Switching output	Electrical connection	Cable length	Part no.	Type
	Clamped	PNP	Open end	2.5 m	538264	SIEH-3B-PS-K-L
			Plug M8, A-coded	0.15 m	538263	SIEH-3B-PS-S-L

Proximity switch SIEN, with cable, inductive – for size 40 ... 80

[Link](#) [sien](#)

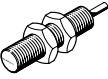
	Type of mounting	Switching output	Electrical connection	Cable length	Part no.	Type
	Via lock nut	PNP	Open end	2.5 m	150386	SIEN-M8B-PS-K-L

Proximity switch SIEN, without cable, inductive – for size 40 ... 80

[Link](#) [sien](#)

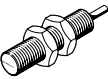
	Type of mounting	Switching output	Electrical connection	Part no.	Type
	Via lock nut	PNP	Plug M8, A-coded	150387	SIEN-M8B-PS-S-L

Accessories

Connecting cable NEBU, straight, connection M8

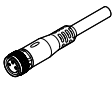
	Electrical connection 1, connector system	Electrical connection 2, connector system	Electrical connection 2, number of connections/cores	Cable length	Part no.	Type
	M8x1, A-coded, to EN 61076-2-104	Open end	3	2.5 m	541333	NEBU-M8G3-K-2.5-LE3
				5 m	541334	NEBU-M8G3-K-5-LE3

Connecting cable NEBU, angled, M8 connection

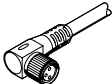
	Electrical connection 1, connector system	Electrical connection 2, connector system	Electrical connection 2, number of connections/cores	Cable length	Part no.	Type
	M8x1, A-coded, to EN 61076-2-104	Open end	3	2.5 m	541338	NEBU-M8W3-K-2.5-LE3
				5 m	541341	NEBU-M8W3-K-5-LE3