

Round cylinders ESNU

FESTO

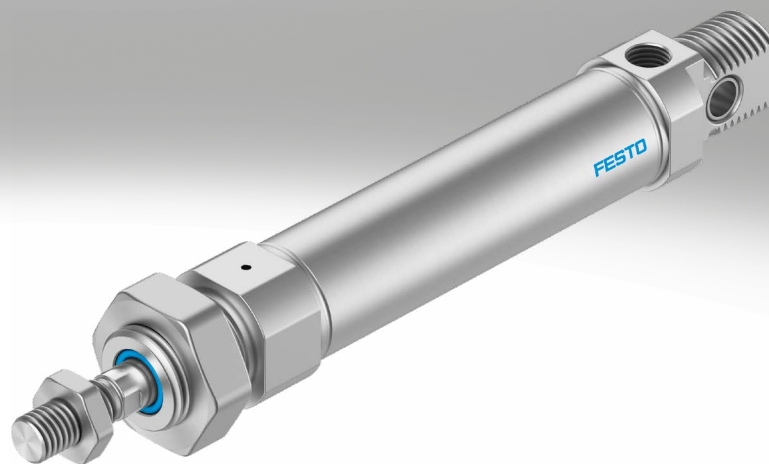

Key features

At a glance

ESNU-8 ... 63

- Stainless steel piston rod
- Good running performance and long service life
- Piston rod with male and female thread

ESNU-8 ... 25

- Extensive range of accessories makes it possible to install the cylinder virtually anywhere



- The basic versions conform to ISO 6432, variants are based on these standards

Wide choice of variants

ESNU-...

- Piston \varnothing 8 ... 63 mm
- Cylinder barrel made of stainless steel
- Bearing and end caps made of wrought aluminium alloy

ESNU-...-MA

- Piston \varnothing 8 ... 63 mm
- Cylinder barrel made of stainless steel
- Bearing cap with threaded flange
- Short end cap with axial supply port



Cushioning types

Cushioning P

Operating mode

- The drive is fitted with polymer elastic end-position cushioning







Application

- Small loads
- Low speeds
- Low impact energies

Benefits

- No adjustment required
- Saves time

Key features

Further variants		
Symbol	Key features	Description
	K2 Extended male piston rod thread	–
	K3 Female piston rod thread	–
	K5 Special piston rod thread	Metric standard thread to ISO
	K6 Shortened male piston rod thread	–
	K8 Extended piston rod	–
	A6 Metal scraper (32 ... 63 mm)	The cylinder has a hard-chrome-plated piston rod and metal scraper, which scrapes off hard particles (e.g. welding spatter) that stick to the piston rod. For use in welding systems, for example

Longer service life with bellows kit DADB



The bellows protects the piston rod, the seal and the bearing from the effects of a wide range of media, which has a positive impact on the service life of these components.

The bellows kit is a leak-free system. To prevent unwanted media from being drawn in, the supply and exhaust air for the kit must be ducted via a pressure compensation hole in the connection part.

The kit protects the piston rod, seal and bearing against a wide variety of media, for example:

- Dust
- Chippings
- Oil
- Grease
- Petrol

Product range overview

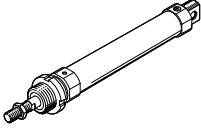
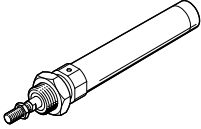
Function	Version	Piston \varnothing	Stroke	Variable stroke ¹⁾	Cushioning Fixed	Position sensing
		[mm]	[mm]	[mm]	P	A
Single-acting	ESNU-... – With position sensing					
		8 ... 63	10, 25, 50	1 ... 50	■	■
	ESNU-MA-... – Axial supply port					
		8 ... 63	–	1 ... 50	■	■

1) Cylinders with position sensing require a minimum stroke of 10 mm to ensure reliable sensing

Product range overview

Piston \varnothing	Piston rod					→ Page/ Internet
	Extended K8	Male thread			Female thread K3	
		Extended K2	Shortened K6	Custom thread K5		
ESNU-... – With position sensing						
8 ... 63	■	■	■	■	■	9
ESNU-MA-... – Axial supply port						
8 ... 63	■	■	■	■	■	9

Peripherals overview

ESNU-...

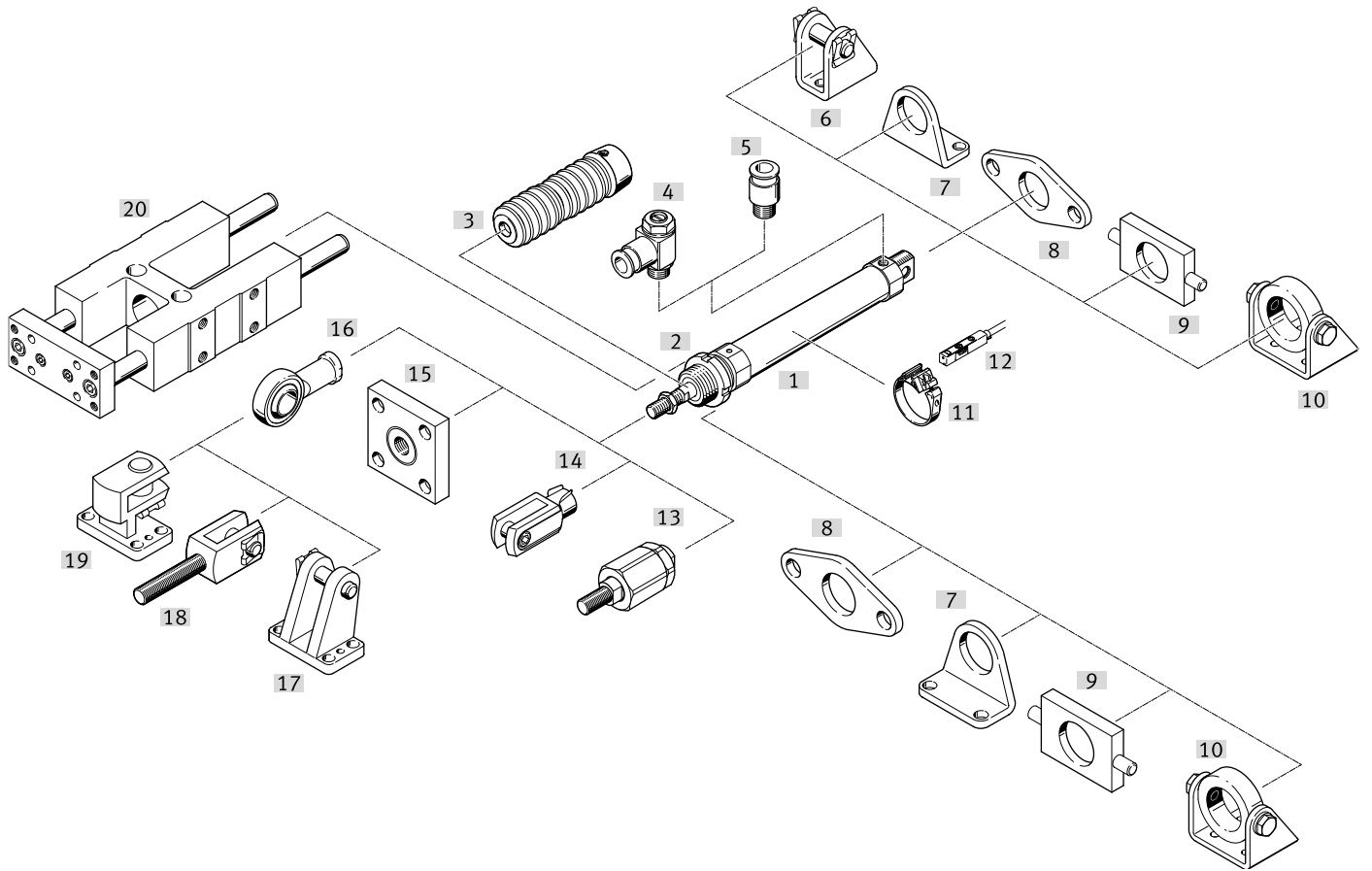

Peripherals overview

Mounting attachments and accessories		Piston \varnothing	ESNU	MA	→ Page/ Internet
[1]	Round cylinders ESNU				
[2]	Hex nut MSK	16 ... 25	■	■	26
[3]	Bellows kit ²⁾ DADB	12 ... 63	■	■	28
[4]	One-way flow control valve GRLZ	8 ... 63	■	■	33
[5]	Push-in fitting QS	8 ... 63	■	■	qs
[6]	Clevis foot LBN/CRLBN	8 ... 63	■	—	25
[7]	Foot mounting HBN/CRHBN/CRH	8 ... 63	■	■	20
[8]	Flange mounting FBN/CRFBN/CRFV	8 ... 63	■	■	22
[9]	Swivel mounting ¹⁾ WBN	8 ... 63	■	■	24
[10]	Swivel mounting ¹⁾ SBN	20 ... 63	■	■	24
[11]	Mounting kit SMBR	12 ... 63	■	■	31
[12]	Proximity switch SMT/SDBT	8 ... 63	■	■	31
	Position transmitter SDAS/SDAT/SMAT	8 ... 63	■	■	32
[13]	Self-aligning rod coupler FK/CRFK	8 ... 63	■	■	26
[14]	Rod clevis SG/CRSG	8 ... 63	■	■	26
[15]	Coupling piece KSG/KSZ	12 ... 63	■	■	26
[16]	Rod eye SGS/CRSGS	8 ... 63	■	■	26
[17]	Clevis foot LBG	32 ... 63	■	■	25
[18]	Rod clevis SGA	32 ... 63	■	■	26
[19]	Right-angle clevis foot LQG	32 ... 63	■	■	25
[20]	Guide unit FEN	8 ... 25	■	■	27

 **Note**

- 1) Cannot be used on the bearing cap in combination with bellows kit DADB.
- 2) The bellows kit protects the cylinder (piston rod, seal and bearings) against a wide range of media and thus prevents premature wear. It can only be used in combination with an extended piston rod (K8)

Type codes

ESNU-...

001	Series	
ESNU	Round cylinder, single-acting, pressing, based on ISO 6432	

002	Piston diameter	
8	8	
10	10	
12	12	
16	16	
20	20	
25	25	
32	32	
40	40	
50	50	
63	63	

003	Stroke	
...	1 ... 50	

004	Cushioning	
P	Elastic cushioning rings/plates on both sides	

005	Position sensing	
A	For proximity sensor	

006	End cap	
	Standard	
MA	Axial supply port	

007	Piston rod thread extension	
	None	
K2	1 ... 35 mm	

008	K6 - Shortened male piston rod thread	
	None	
K6	1 ... 10 mm	

009	Piston rod thread type	
	Male thread	
K3	Female thread	

010	Custom thread	
"M10"K5	M10	
"M12"K5	M12	
"M16"K5	M16	

011	Piston rod extension	
	None	
...K8	1 ... 50 mm	

Datasheet

P cushioning

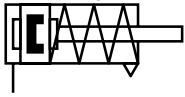

-  - Diameter
8 ... 25 mm
ISO 6432

-  - Diameter
32 ... 63 mm

-  - Stroke length
1 ... 50 mm



General technical data

Piston Ø	8	10	12	16	20	25	32	40	50	63
Conforms to standard	ISO 6432						-			
Pneumatic connection	M5	M5	M5	M5	G1/8	G1/8	G1/8	G1/4	G1/4	G3/8
Piston rod thread	M4	M4	M6	M6	M8	M10x1.25	M10x1.25	M12x1.25	M16x1.5	M16x1.5
Stroke ¹⁾ [mm]	1 ... 50									
Design	Piston/piston rod/cylinder barrel									
Cushioning	Elastic cushioning rings/plates at both ends									
Position sensing	Via proximity switch									
Type of mounting	With accessories									
Mounting position	Any									

1) Cylinders with position sensing require a minimum stroke of 10 mm to ensure reliable sensing

Operating and environmental conditions

	8	10	12	16	20	25	32	40	50	63
Operating medium	Compressed air to ISO 8573-1:2010 [7:4:4]									
Note on the operating/pilot medium	Lubricated operation possible (in which case lubricated operation will always be required)									
Operating pressure	[MPa]	0.15 ... 1			0.12 ... 1					
	[bar]	1.5 ... 10			1.2 ... 10					
Ambient temperature ¹⁾ [°C]	-20 ... +80									
Corrosion resistance class CRC ²⁾	2									

1) Note operating range of proximity switches

2) More information www.festo.com/x/topic/crc

Datasheet

Forces [N] and impact energy [J]										
Piston ø	8	10	12	16	20	25	32	40	50	63
Theoretical force at 0.6 MPa (6 bar), advancing	24	41	61	107	169	270	442	688	1071	1763
Theoretical spring return force										
Stroke 10 mm	4.9	4.9	6.3	13.2	18.3	22.9	36	60	95	95
Stroke 25 mm	4.1	4.1	5.4	11.9	16.5	21.2	30	50	82	82
Stroke 50 mm	2.8	4.8	3.9	9.8	13.6	18.5	20	30	60	60
Impact energy in the end positions ¹⁾	0.03	0.05	0.07	0.15	0.20	0.30	0.40	0.70	1	1.3

1) The values are reduced by approx. 50% at ambient temperatures of 80 °C

Weight ESNU-... [g]										
Piston ø	8	10	12	16	20	25	32	40	50	63
Product weight with 0 mm stroke	35	37.3	75	89.9	186.8	238	370.5	661	1087	1445
Additional weight per 10 mm stroke	2.4	2.7	4	4.6	7.2	11	15.5	24	40	44

Weight ESNU-...-MA [g]										
Piston ø	8	10	12	16	20	25	32	40	50	63
Product weight with 0 mm stroke	30	33	65	81	167	222	330	585	1013	1369
Additional weight per 10 mm stroke	2.4	2.7	4	4.6	7.2	11	15.5	24	40	44

Materials

Sectional view

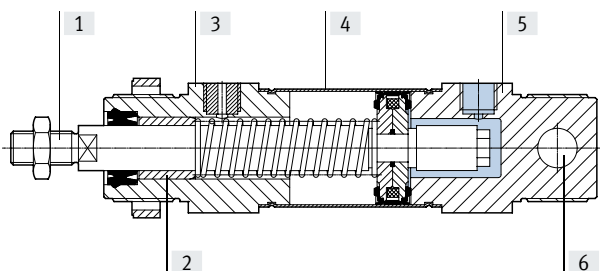

Round cylinder		
[1]	Piston rod	High-alloy steel
[2]	Piston rod bearing	Sintered bronze
[3]	Bearing cap	Anodised aluminium
[4]	Cylinder barrel	High-alloy stainless steel
[5]	End cap	Anodised aluminium
-	Seals	NBR, TPE-U(PU)
-	Spring	Spring steel
	LABS (PWIS) conformity	VDMA24364-B1/B2-L
	Note on materials	RoHS-compliant
[6]	Swivel bearing	Polymer

Datasheet

Download CAD data → www.festo.com

Dimensions

ESNU-8 ... 25

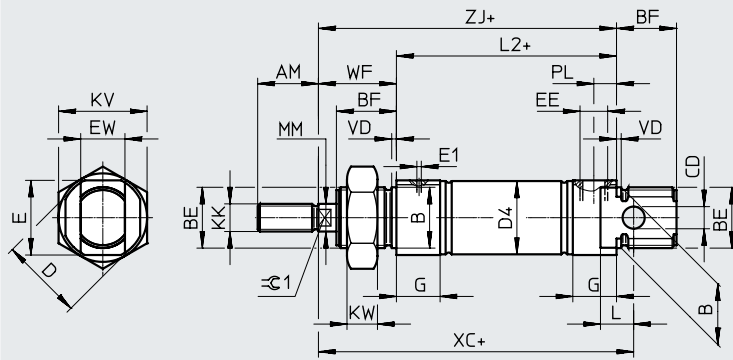

MA – Axial supply port

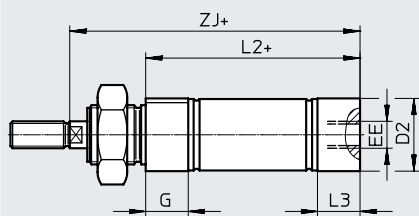

- Note

Piston rod nut is not included in the scope of delivery for diameter 8 ... 20.
+ = plus stroke length

∅ [mm]	AM	B ∅ h8	BE	BF	CD ∅ H9	D ∅	D2 ∅ -MA	D4 ∅	E	E1	EE	EW	G	KK
8	12	12	M12x1.25	12	4	16	10.5	9.3	14	1	M5	8	10	M4
10							12.5	11.3						
12	16	16	M16x1.5	17	6	20	14.5	13.3	18	1.6	G1/8	12	16	M6
16							17.5	17.3						
20	20	22	M22x1.5	20	8	30	21.7	21.3	26	2	G1/8	16	16	M8
25				22			22	26.7						26.5

∅ [mm]	KV	KW	MM ∅	L	L2			L3	PL	VD	WF ±1.2	XC ±1	ZJ		≡C1
					ESNU- ...	-MA	-MA						ESNU- ...	-MA	
8	19	6	4	6	46	43.6	7.6	6	6	2	16	64	62	59.6	-
10						43.1	7.1							59.1	
12	24	8	6	9	50	47.7	7.7	8.2	8.2	22	75	72	69.7	5	
16						56									53.7
20	32	11	8	12	68	66.5	14.5	8.2	8.2	24	95	92	90.5	7	
25			10		69.5	68.5	14								28

Datasheet

Dimensions

Download CAD data → www.festo.com

ESNU-8 ... 25

K2 – Extended male piston rod thread

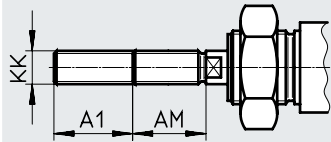

K6 – Shortened male piston rod thread

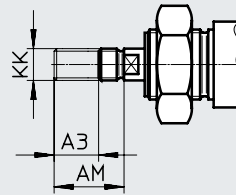

K3 – Female piston rod thread

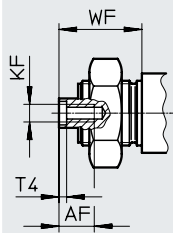

K5 – Special piston rod thread

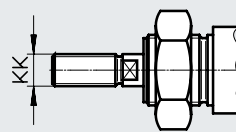

K8 – Extended piston rod

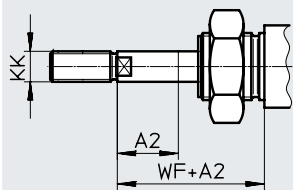

∅ [mm]	A1 max.	A2 max.	A3 max.	AF	AM	KF	KK		T4	WF ±1.2
							Basic thread	Custom thread ¹⁾		
8	15	50	4	–	12	–	M4	–	–	16
10				–		–		–		
12				–		–		–		
16	20		–	–	–	M6	–	–	22	
20	25		–	–	M4		M8	–		2
25	35		8	12	20		M6	M10x1.25		M10

1) The custom threads are only available as male threads. The scope of delivery does not include a hex nut for the piston rod thread

Datasheet

Dimensions

Download CAD data → www.festo.com

ESNU-32 ... 63

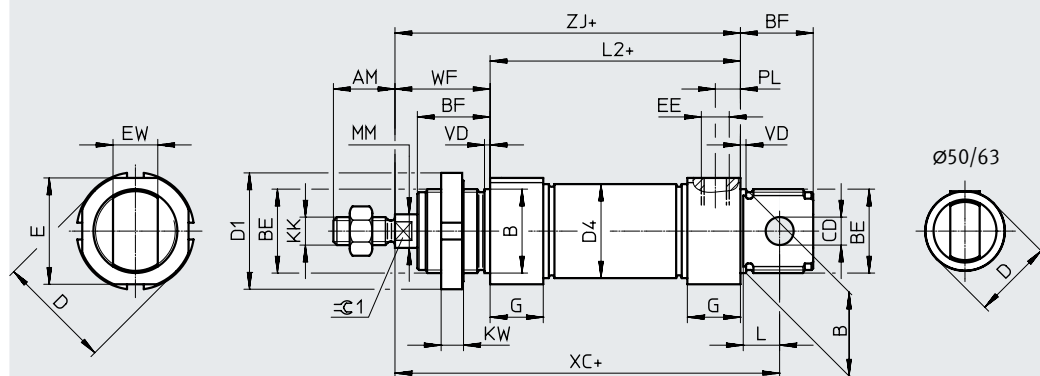

MA – Axial supply port

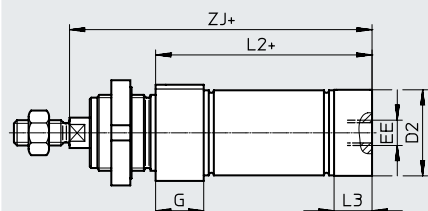

+ = plus stroke length

∅ [mm]	AM	B ∅ h8	BE	BF	CD ∅ H9	D ∅	D1 ∅	D2 ∅	D4 ∅	E	EE	EW	G	KK
32	22	30	M30x1.5	26	10	41	42	34	33.6	38	G1/8	16	19	M10x1.25
40	24	38	M38x1.5	30	12	49	50	42	41.6	45	G1/4	18	25	M12x1.25
50	32	45	M45x1.5	33	16	57	60	53	52.4	–		G3/8		21
63						70		66	65.4	–				

∅ [mm]	KW	L	L2		L3	PL	MM ∅	VD	WF ±1.2	XC ±1	ZJ		≈G1			
			ESNU- ...	-MA							ESNU- ...	-MA				
32	8	13	69.5	65.5	15	9	12	2	34	117.5	103.5	99.5	10			
40			84.6	77.6							18	12		16	39	139.6
50		10	16	86.2	86.2	25	20				3		44	147.2	130.2	130.2
63				94.2	94.2	28						13	45	156.2	139.2	139.2

Datasheet

Dimensions

Download CAD data → www.festo.com

ESNU-32 ... 63

K2 – Extended male piston rod thread

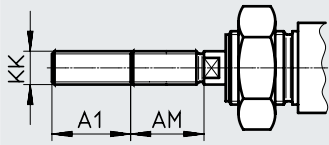

K6 – Shortened male piston rod thread

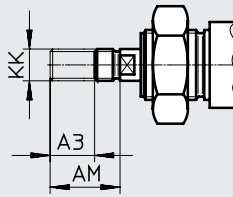

K3 – Female piston rod thread

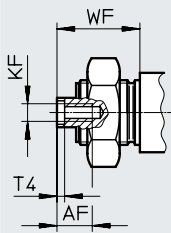

K5 – Special piston rod thread

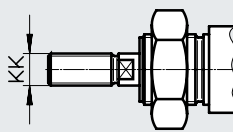

K8 – Extended piston rod

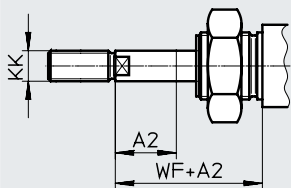

∅ [mm]	A1 max.	A2 max.	A3 max.	AF	AM	KF	KK		T4	WF ±1.2
							Basic thread	Custom thread ¹⁾		
32	35	50	8	12	22	M6	M10x1.25	M10	2.6	34
40							M12x1.25	M12		
50			10	16	32	M10	M16x1.5	M16	4.7	44
63	45									

1) The custom threads are only available as male threads. The scope of delivery does not include a hex nut for the piston rod thread

Datasheet

Ordering data			
Piston ø [mm]	Stroke [mm]	Part no.	Type
8	10	19254	ESNU-8-10-P-A
	25	19255	ESNU-8-25-P-A
	50	19256	ESNU-8-50-P-A
10	10	19257	ESNU-10-10-P-A
	25	19258	ESNU-10-25-P-A
	50	19259	ESNU-10-50-P-A
12	10	19260	ESNU-12-10-P-A
	25	19261	ESNU-12-25-P-A
	50	19262	ESNU-12-50-P-A
16	10	19263	ESNU-16-10-P-A
	25	19264	ESNU-16-25-P-A
	50	19265	ESNU-16-50-P-A
20	10	19266	ESNU-20-10-P-A
	25	19267	ESNU-20-25-P-A
	50	19268	ESNU-20-50-P-A
25	10	19269	ESNU-25-10-P-A
	25	19270	ESNU-25-25-P-A
	50	19271	ESNU-25-50-P-A
32	10	196376	ESNU-32-10-P-A
	25	196377	ESNU-32-25-P-A
	50	196378	ESNU-32-50-P-A
40	10	196379	ESNU-40-10-P-A
	25	196380	ESNU-40-25-P-A
	50	196381	ESNU-40-50-P-A
50	10	196382	ESNU-50-10-P-A
	25	196383	ESNU-50-25-P-A
	50	196384	ESNU-50-50-P-A
63	10	196385	ESNU-63-10-P-A
	25	196386	ESNU-63-25-P-A
	50	196387	ESNU-63-50-P-A

Ordering data			
Piston ø [mm]	Stroke [mm]	Part no.	Type
Variable stroke			
8	1 ... 50	14119	ESNU-8-...-P-A
10	1 ... 50	14118	ESNU-10-...-P-A
12	1 ... 50	14317	ESNU-12-...-P-A
16	1 ... 50	14316	ESNU-16-...-P-A
20	1 ... 50	14319	ESNU-20-...-P-A
25	1 ... 50	14318	ESNU-25-...-P-A

Ordering data – Modular product system

Ordering table									
Size	8	10	12	16	20	25	Conditions	Code	Enter code
Module no.	193996	193997	193998	193999	194000	194001			
Function	Round cylinder, single-acting, pushing, based on ISO 6432							ESNU	ESNU
Piston ø [mm]	8	10	12	16	20	25		-...	
Stroke [mm]	1 ... 50								-...
Cushioning	Elastic cushioning rings/plates at both ends								-P
Position sensing	Via proximity switch						[1]		-A
End cap	Axial supply port								-MA

[1] A Minimum stroke ≥ 10 mm required for reliable sensing



Note

Cylinders with position sensing require a minimum stroke of 10 mm to ensure reliable sensing. Longer strokes on request

Ordering data – Modular product system

Ordering table									
Size	8	10	12	16	20	25	Conditions	Code	Enter code
Extended male thread	Extended male piston rod thread								
	[mm]	1 ... 15	1 ... 20		1 ... 25	1 ... 35	[2]	-...K2	
Shortened male thread	Shortened male piston rod thread								
	[mm]	1 ... 4			1 ... 8			-...K6	
Female thread	Piston rod with female thread								
		-	-	-	-	(M4)	(M6)	[3]	-K3
Custom thread	Special piston rod thread								
		-	-	-	-	M10		-"...K5	
Extended piston rod	Extended piston rod								
	[mm]	1 ... 50						...K8	

[2] K2 Not with female thread K3, shortened male thread K6

[3] K3 Not with custom thread K5, shortened male thread K6

Ordering data – Modular product system

Ordering table							
Size	32	40	50	63	Conditions	Code	Enter code
Module no.	194002	194003	194004	194005			
Function	Single-acting round cylinder					ESNU	ESNU
Piston ø [mm]	32	40	50	63		-...	
Stroke [mm]	1 ... 50					-...	
Cushioning	Elastic cushioning rings/plates at both ends					-P	-P
Position sensing	Via proximity switch				[1]	-A	-A
End cap	Axial supply port					-MA	

[1] A Minimum stroke ≥ 10 mm required for reliable sensing

 **Note**

Cylinders with position sensing require a minimum stroke of 10 mm to ensure reliable sensing. Longer strokes on request

Ordering data – Modular product system

Ordering table							
Size	32	40	50	63	Conditions	Code	Enter code
Extended male thread	Extended male piston rod thread				[2]	-...K2	
	[mm]	1 ... 35					
Shortened male thread	Shortened male piston rod thread					-...K6	
	[mm]	1 ... 8	1 ... 10				
Female thread	Piston rod with female thread				[3]	-K3	
	(M6)	(M8)	(M10)				
Custom thread	Special piston rod thread					-“...”K5	
	M10	M12	M16				
Extended piston rod	Extended piston rod					...K8	
	[mm]	1 ... 50					

[2] K2 Not with female thread K3, shortened male thread K6

[3] K3 Not with custom thread K5, shortened male thread K6

Accessories

Foot mounting HBN/CRHBN

Scope of delivery:

HBN/CRHBN-...x1: 1 foot

HBN/CRHBN-...x2: 2 feet and 1 nut

Material:

HBN: Galvanised steel

CRHBN: High-alloy stainless steel

RoHS-compliant

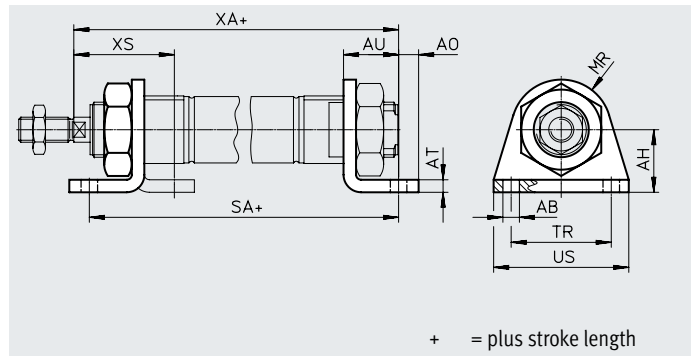

Dimensions and ordering data

For \varnothing [mm]	AB \varnothing	AH	AO	AT	AU	R1	SA	TR	US	XA	XS
8, 10	4.5	16	5	3	11	10	68	25	35	73	24
12	5.5	20	6	4	14	13	78	32	42	86	32
16	5.5	20	6	4	14	13	84	32	42	92	32
20	6.6	25	8	5	17	20	102	40	54	109	36
25	6.6	25	8	5	17	20	103.5	40	54	114.5	40

For \varnothing [mm]	Basic version				High corrosion protection			
	CRC ¹⁾	Weight [g]	Part no.	Type	CRC ¹⁾	Weight [g]	Part no.	Type
8, 10	1	22	5123	HBN-8/10x1	-	-	-	
	1	54	5124	HBN-8/10x2	-	-	-	
12, 16	1	43	5125	HBN-12/16x1	4	43	161866	CRHBN-12/16x1
	1	107	5126	HBN-12/16x2	4	107	162999	CRHBN-12/16x2
20, 25	1	95	5127	HBN-20/25x1	4	94	161867	CRHBN-20/25x1
	1	237	5128	HBN-20/25x2	4	236	162998	CRHBN-20/25x2

1) More information www.festo.com/x/topic/crc

Accessories

Foot mounting HBN/CRH

Material:
 HBN: Galvanised steel
 CRH: High-alloy stainless steel
 RoHS-compliant

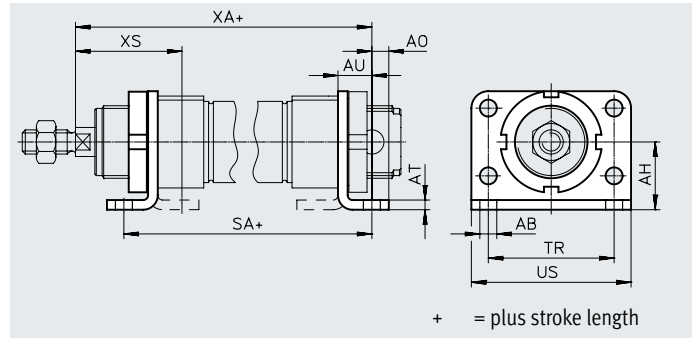

Dimensions and ordering data

For \varnothing [mm]	AB \varnothing	AH	AO	AT	AU	SA	TR	US	XA	XS
32	7	28	7	4	14	97.5	52	66	117.5	44
40	9	33	10	5	20	124.6	60	80	143.6	54
50	9	40	10	6	20	126.2	70	90	150.2	58
63	9	45	10	6	20	134.2	76	96	159.2	59

For \varnothing [mm]	Basic version				High corrosion protection			
	CRC ¹⁾	Weight [g]	Part no.	Type	CRC ¹⁾	Weight [g]	Part no.	Type
32	1	353	195851	HBN-32x2	4	353	162951	CRH-32
40	1	611	195852	HBN-40x2	4	611	162952	CRH-40
50	1	916	195853	HBN-50x2	4	916	162953	CRH-50
63	1	1066	195854	HBN-63x2	4	1066	162954	CRH-63

1) More information www.festo.com/x/topic/crc

Accessories

Flange mounting FBN/CRFBN

Material:
 FBN: Galvanised steel
 CRFBN: High-alloy stainless steel

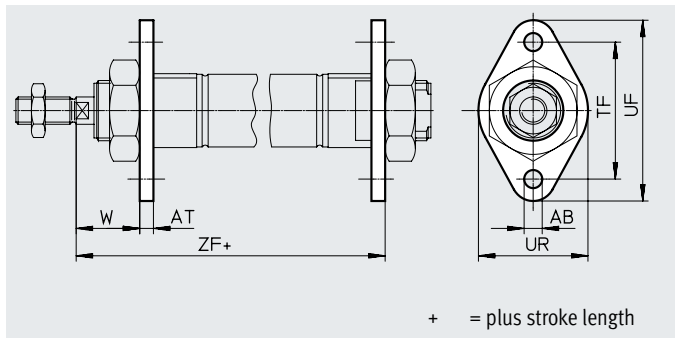
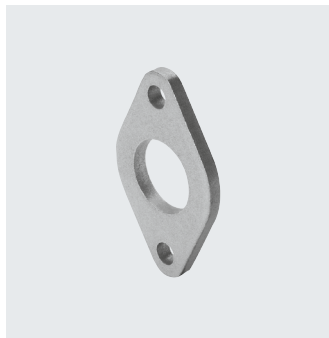

Dimensions and ordering data

For \varnothing [mm]	AB \varnothing	AT	TF	UF	UR	W	ZF
8, 10	4.5	3	30	40	25	13	65
12	5.5	4	40	53	30	18	76
16	5.5	4	40	53	30	18	82
20	6.6	5	50	66	40	19	97
25	6.6	5	50	66	40	23	102.5

For \varnothing [mm]	Basic version				High corrosion protection			
	CRC ¹⁾	Weight [g]	Part no.	Type	CRC ¹⁾	Weight [g]	Part no.	Type
8, 10	1	12	5129	FBN-8/10	-	-	-	-
12, 16	1	26	5130	FBN-12/16	4	26	161864	CRFBN-12/16
20, 25	1	52	5131	FBN-20/25	4	52	161865	CRFBN-20/25

1) More information www.festo.com/x/topic/crc

Accessories

Flange mounting FBN/CRFV

Material:

FBN: Galvanised steel

CRFV: High-alloy stainless steel

RoHS-compliant

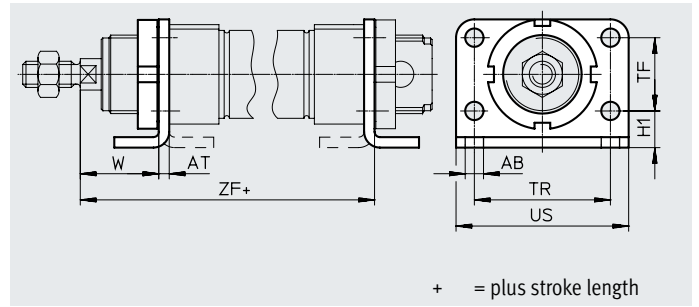

Dimensions and ordering data

For \varnothing [mm]	AB \varnothing	AT	H1	TF	TR	US	W	ZF
32	7	4	14	28	52	66	30	107.5
40	9	5	18	30	60	80	29	128.6
50	9	6	20	40	70	90	38	136.2
63	9	6	20	50	76	96	39	145.2

For \varnothing [mm]	Basic version				High corrosion protection			
	CRC ¹⁾	Weight [g]	Part no.	Type	CRC ¹⁾	Weight [g]	Part no.	Type
32	1	103	195855	FBN-32	4	103	161858	CRFV-32
40	1	191	195856	FBN-40	4	191	161859	CRFV-40
50	1	292	195857	FBN-50	4	292	161860	CRFV-50
63	1	367	195858	FBN-63	4	367	161861	CRFV-63

1) More information www.festo.com/x/topic/crc

Accessories

Swivel mounting SBN

Material:
 Retaining ring: Anodised wrought aluminium alloy
 Bearing: Bronze
 Screws: Galvanised steel
 Bracket: Steel
 Cannot be used on the bearing cap in combination with bellows kit DADB.

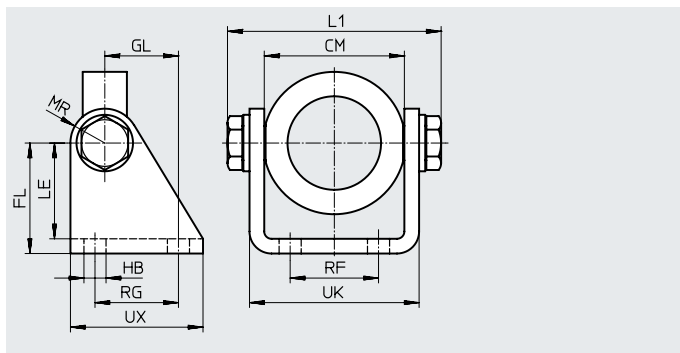
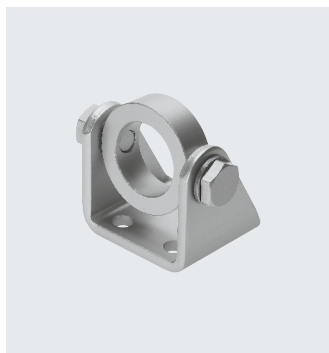

Dimensions and ordering data

For \varnothing [mm]	CM	FL	GL	HB	L1 max.	LE	MR	RF	RG	UK	UX	CRC ¹⁾	Weight [g]	Part no.	Type
20/25	38.1+0.4	35	20	7	60.2	31	12	20	24	46.1	40	1	238	539927	SBN-20/25
32	46.1+0.2	40	27	9	72.2	35	13	28	30	56.1	50	1	361	539924	SBN-32
40	57.1+0.2	45	30	9	88.2	39	14	36	34	69.1	54	1	593	539925	SBN-40
50/63	70.1+0.4	50	34	9	102.2	44	16	42	35	82.1	65	1	894	539926	SBN-50/63

1) More information www.festo.com/x/topic/crc

Swivel mounting WBN

Material:
 Galvanised steel
 RoHS-compliant
 Cannot be used on the bearing cap in combination with bellows kit DADB.

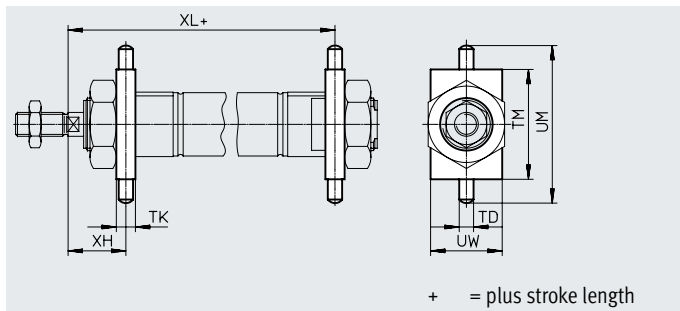
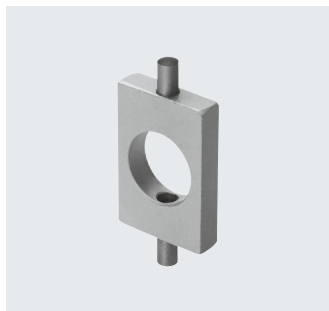

+ = plus stroke length

Dimensions and ordering data

For \varnothing [mm]	TD \varnothing -0.01/ -0.05	TK	TM	UM	UW	XH	XL	CRC ¹⁾	Weight [g]	Part no.	Type
8, 10	4	6	26	38	20	13	65	1	20	8608	WBN-8/10
12	6	8	38	58	25	18	76	1	51	8609	WBN-12/16
16	6	8	38	58	25	18	82	1	51	8609	WBN-12/16
20	6	8	46	66	30	20	96	1	67	8610	WBN-20/25
25	6	8	46	66	30	24	101.5	1	67	8610	WBN-20/25
32	8	12	50	76	40	28	109.5	1	131	195863	WBN-32
40	10	15	60	92	50	31.5	126.1	1	238	195864	WBN-40
50	12	20	80	116	65	34	140.2	1	596	195865	WBN-50/63
63	12	20	80	116	65	35	149.2	1	596	195865	WBN-50/63

1) More information www.festo.com/x/topic/crc

Accessories

Clevis foot LBN/CRLBN

Material:

LBN: galvanised steel

CRLBN: High-alloy stainless steel

RoHS-compliant

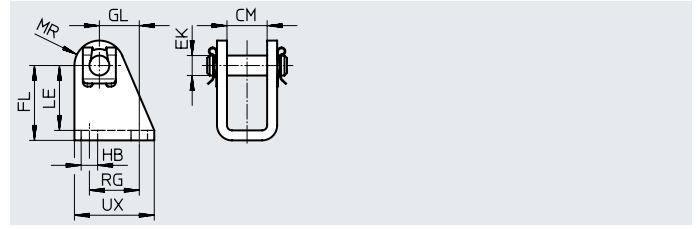
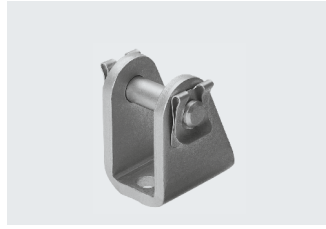



Dimensions and ordering data									
For \varnothing [mm]	CM	EK \varnothing	FL	GL	HB	LE	MR	RG	UX
8, 10	8.1	4	24 +0.3/-0.2	13.8	4.5	21.5	5	12.5	20
12, 16	12.1	6	27 +0.3/-0.2	13	5.5	24	7	15	25
20, 25	16.1	8	30 +0.4/-0.2	16	6.6	26	10	20	32
32	16.1	10	35 +0.4/-0.2	18.5	6.6	31	11	24	35
40	18.1	12	40 +0.4/-0.2	24.5	9	35	13	30	45
50, 63	21.1	16	45 +0.5/-0.2	28	9	39	14	34	50

For \varnothing [mm]	Basic version				High corrosion protection			
	CRC ¹⁾	Weight [g]	Part no.	Type	CRC ¹⁾	Weight [g]	Part no.	Type
8, 10	1	20	6057	LBN-8/10	-	-	-	
12, 16	1	40	6058	LBN-12/16	4	39	161862	CRLBN-12/16
20, 25	1	84	6059	LBN-20/25	4	82	161863	CRLBN-20/25
32	1	110	195860	LBN-32	4	106	195866	CRLBN-32
40	1	191	195861	LBN-40	4	185	195867	CRLBN-40
50, 63	1	300	195862	LBN-50/63	4	283	195868	CRLBN-50/63

1) More information www.festo.com/x/topic/crc

Accessories

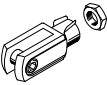
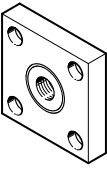
Ordering data – Piston rod attachments

Designation	For ø	Part no.	Type
Rod eye SGS			
	8	9253	SGS-M4
	10		
	12	9254	SGS-M6
	16		
	20		
	25	9255	SGS-M8
	32	9261	SGS-M10x1.25
	40		
	50	9262	SGS-M12x1.25
	63	9263	SGS-M16x1.5
Rod clevis SG			
	8	6532	SG-M4
	10		
	12	3110	SG-M6
	16		
	20		
	25	3111	SG-M8
	32	6144	SG-M10x1.25
	40		
	50	6145	SG-M12x1.25
	63	6146	SG-M16x1.5
Coupling piece KSG			
	12	-	
	16		
	20		
	25	32963	KSG-M10x1.25
	32		
	40	32964	KSG-M12x1.25
	50	32965	KSG-M16x1.5
63			
Hex nut MSK			
	16	189007	MSK-M16x1.5
	20	189009	MSK-M22x1.5
	25		

Datasheets → Internet: piston rod attachment

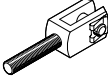
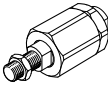
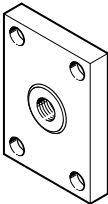
Designation	For ø	Part no.	Type		
Rod clevis SGA					
	8	-			
	10				
	12				
	16				
	20				
	25				
	32			32954	SGA-M10x1.25
	40			10767	SGA-M12x1.25
	50			10768	SGA-M16x1.5
	63				
Self-aligning rod coupler FK					
	8	6528	FK-M4		
	10				
	12	2061	FK-M6		
	16				
	20				
	25	2062	FK-M8		
	32	6140	FK-M10x1.25		
	40				
	50	6141	FK-M12x1.25		
	63	6142	FK-M16x1.5		
Coupling piece KSZ					
	12	36123	KSZ-M6		
	16				
	20	36124	KSZ-M8		
	25				
	32				
	40	36126	KSZ-M12x1.25		
	50				
63	36127	KSZ-M16x1.5			

Accessories

Ordering data – Piston-rod attachments, corrosion-resistant

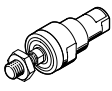
Designation	For ø	Part no.	Type
Rod eye CRSGS			
	12	195580	CRSGS-M6
	16		
	20	195581	CRSGS-M8
	25	195582	CRSGS-M10x1.25
	32		
	40	195583	CRSGS-M12x1.25
	50	195584	CRSGS-M16x1.5
63			
Self-aligning rod coupler CRFK			
	25	2305778	CRFK-M10x1.25
	32		
	40	2305779	CRFK-M12x1.25
	50	2490673	CRFK-M16x1.5
	63		

Datasheets → Internet: piston rod attachment

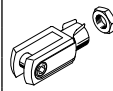
Designation	For ø	Part no.	Type
Rod clevis CRSG			
	12	13567	CRSG-M6
	16		
	20	13568	CRSG-M8
	25	13569	CRSG-M10x1.25
	32		
	40	13570	CRSG-M12x1.25
	50	13571	CRSG-M16x1.5
63			

Ordering data – Mounting components

Designation	For ø	Part no.	Type
Clevis foot LBG			
	32	31761	LBG-32
	40	31762	LBG-40
	50	31763	LBG-50
	63	31764	LBG-63

Datasheets → Internet: clevis foot

Designation	For ø	Part no.	Type
Right angle clevis foot LQG			
	32	31768	LQG-32
	40	31769	LQG-40
	50	31770	LQG-50
	63	31771	LQG-63

Ordering data – Guide units

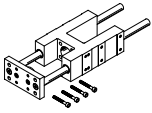
	For ø	Stroke [mm]	With recirculating ball bearing guide		With plain-bearing guide	
			Part no.	Type	Part no.	Type
	8, 10	1 ... 100	35197	FEN-8/10-...-KF	35196	FEN-8/10-...-GF
	12, 16	1 ... 200	33481	FEN-12/16-...-KF	19168	FEN-12/16-...-GF
	20	2 ... 250	33482	FEN-20-...-KF	19169	FEN-20-...-GF
	25	2 ... 250	33483	FEN-25-...-KF	19170	FEN-25-...-GF

Datasheets → Internet: feng

Accessories

Bellows kit DADB



General technical data						
Type DADB-S1-	20	25	32	40	50	63
Max. stroke range of the cylinder ¹⁾²⁾ [mm]	10 ... 50					
Type of mounting	Via threaded pin					
Mounting position	Any					
Media resistance	Dust, chippings, oil, grease, fuel (→ Internet: media resistance)					
Ambient temperature ³⁾ [°C]	-10 ... +80					
Corrosion resistance class CRC ⁴⁾	3					

- 1) In conjunction with the bellows kit DADB
- 2) Slight change in spring return force
- 3) Note operating range of proximity switches and cylinder
- 4) More information www.festo.com/x/topic/crc

Materials

Sectional view

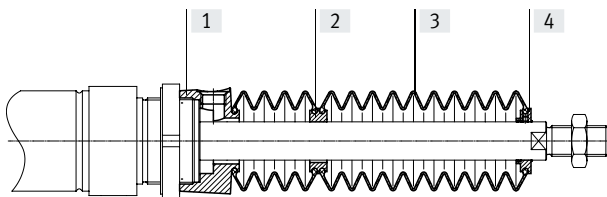

Bellows		
[1] Connection	Polyamide	
[2] Adapter	Polyamide	
[3] Protective bellows	NBR	
[4] End piece	Polyamide	
- O-ring	NBR	
Note on materials	RoHS-compliant	

Weight [g]			
Type DADB-S1- Stroke [mm]	20	25	32
10 ... 50	20	19	29
Type DADB-S1- Stroke [mm]	40	50	63
10 ... 50	34	55	55

Accessories

Travel speed v as a function of tubing length l



The bellows kit is a leak-free system.

To prevent unwanted media from being drawn in, the supply or exhaust air of the kit is ducted in the connection part via a pressure compensation opening.

The pressure generated in the bellows kit by the positioning motion is primarily defined by the travel speed and tubing length. The recommended tube length in relation to the travel speed of the drive can be read from the diagram.

Advancing

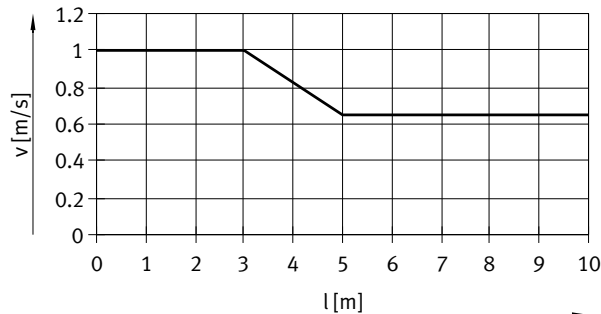

ESNU-20/25

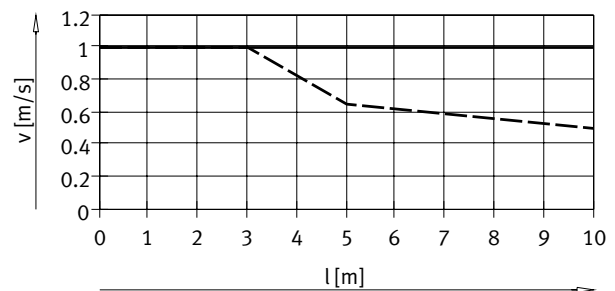

ESNU-32/50/63

ESNU-40

Retracting

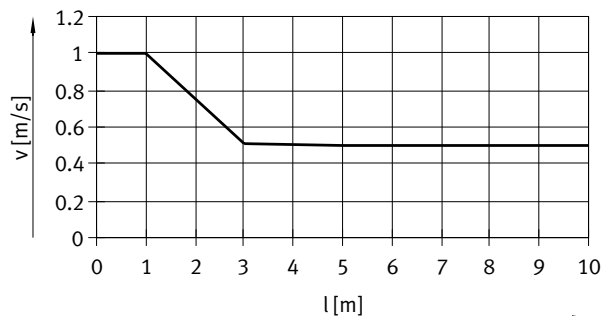

ESNU-20/25

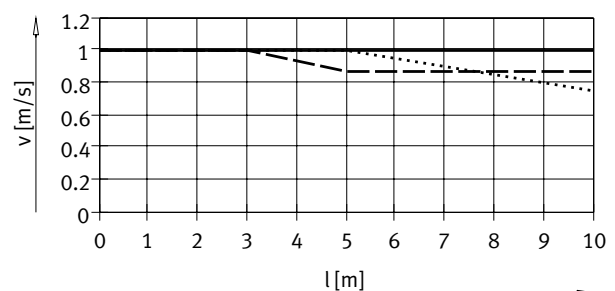

ESNU-32

ESNU-40

ESNU-50/63

Note
The push-in fittings in the adjacent table must be used for the pressure compensation hole. Silencers can be used as an alternative. This reduces the travel speed slightly.

Tubing size and push-in fitting for pressure compensation hole			
∅ [mm]	Tubing O.D. [mm]	Push-in fitting Part no.	Type
20, 25	6	★ 153317	QSM-M5-6-I
		578371	NPQH-DK-M5-Q6-P10
		578335	NPQH-D-M5-Q6-P10
		578359	NPQH-D-M5-S6-P10
32, 40	8	★ 186109	QS-G1/8-8-I
		578376	NPQH-DK-G18-Q8-P10
		578362	NPQH-D-G18-S8-P10
50, 63	12	★ 186350	QS-G1/4-12
		578344	NPQH-D-G14-Q12-P10
		578366	NPQH-D-G14-S12-P10

Accessories

Dimensions

Download CAD data → www.festo.com

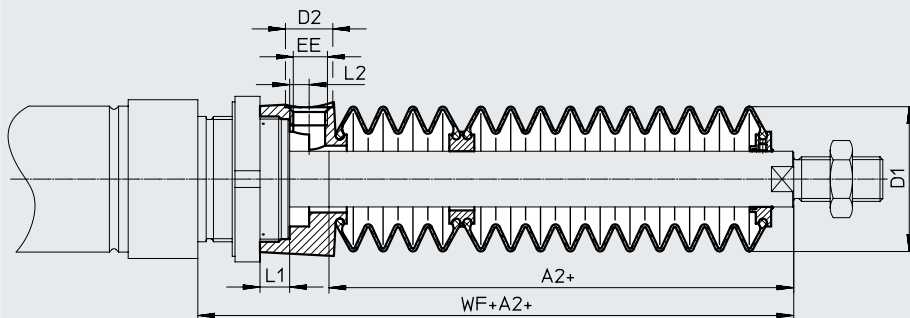

∅ Stroke [mm]	20							25						
	A2 ¹⁾	D1 ∅ max.	D2 ∅	EE	L1	L2	WF+A2	A2 ¹⁾	D1 ∅ max.	D2 ∅	EE	L1	L2	WF+A2
10 ... 50	22	29	8.5	M5	4.2	2.7	46	22	29	8.5	M5	4.2	2.7	50

∅ Stroke [mm]	32							40						
	A2 ¹⁾	D1 ∅ max.	D2 ∅	EE	L1	L2	WF+A2	A2 ¹⁾	D1 ∅ max.	D2 ∅	EE	L1	L2	WF+A2
10 ... 50	30	38	14	G1/8	12.9	5.4	64	29	46	14	G1/8	8.1	5.4	68

∅ Stroke [mm]	50/63						
	A2 ¹⁾	D1 ∅ max.	D2 ∅	EE	L1	L2	WF+A2
10 ... 50	30	57	17	G1/4	10.65	7	74/75

1) The dimension corresponds to the K8 value (extended piston rod) of the drive

Ordering data – Bellows kit

An extended piston rod (order code K8) is absolutely essential when using a bellows kit → Ordering data – Modular product system.

In the table below the required dimension for K8 is specified as a function of piston diameter and cylinder stroke as well as the associated bellows kit:

Cylinder data			Bellows kit		Cylinder data			Bellows kit	
∅	Stroke	Dimension for K8	Part no.	Type	∅	Stroke	Dimension for K8	Part no.	Type
[mm]	[mm]	[mm]			[mm]	[mm]	[mm]		
20	10 ... 50	22	553407	DADB-S1-20-S10-50	25	10 ... 50	22	553421	DADB-S1-25-S10-50
32	10 ... 50	30	553441	DADB-S1-32-S10-50	40	10 ... 50	29	553461	DADB-S1-40-S10-50
50	10 ... 50	30	553481	DADB-S1-50-S10-50	63	10 ... 50	30	553501	DADB-S1-63-S10-50

Accessories

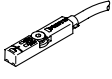
Ordering data – Proximity switch for T-slot, magneto-resistive							Datasheets → Internet: smt
	Type of mounting	Switching output	Electrical connection	Cable length [m]	Part no.	Type	
N/O							
	Inserted in the slot from above, flush with the cylinder profile, short design	PNP	Cable, 3-core	2.5	574335	SMT-8M-A-PS-24V-E-2.5-OE	
			Cable, 2-core	5	8165237	SMT-8M-A-ZS-24V-E-5.0-OE	
			Plug M8x1, 3-pin	0.3	574334	SMT-8M-A-PS-24V-E-0.3-M8D	
		NPN	Cable, 3-core	2.5	574338	SMT-8M-A-NS-24V-E-2.5-OE	
			Plug M8x1, 3-pin	0.3	574339	SMT-8M-A-NS-24V-E-0.3-M8D	

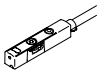
Ordering data – Proximity switch for T-slot, magnetic Hall							Datasheets → Internet: sbdt
	Type of mounting	Switching output	Electrical connection	Cable length [m]	Part no.	Type	
N/O or N/C contact, switchable							
	Inserted in the slot from above, flush with the cylinder profile, short design	PNP, switchable to NPN	Plug M8x1, 3-pin	0.3	8059120	SDBT-MSX-1L-PU-E-0.3-N-M8	
			Cable, 3-core	2.5	8059121	SDBT-MSX-1L-PU-E-2.5-N-LE	
		NPN, switchable to PNP	Plug M8x1, 3-pin	0.3	8059123	SDBT-MSX-1L-NU-E-0.3-N-M8	
			Cable, 3-core	2.5	8059124	SDBT-MSX-1L-NU-E-2.5-N-LE	

Ordering data – Mounting kits for proximity switches SMT/SDBT				Datasheets → Internet: smbr		
Designation	For Ø			Part no.	Type	
Mounting kit SMBR-8						
	8			175091	SMBR-8-8	
	10			175092	SMBR-8-10	
	12			175093	SMBR-8-12	
	16			175094	SMBR-8-16	
	20			175095	SMBR-8-20	
	25			175096	SMBR-8-25	
	32			175097	SMBR-8-32	
	40			175098	SMBR-8-40	
	50			175099	SMBR-8-50	
63			175100	SMBR-8-63		

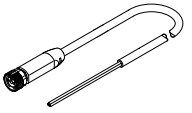
Connecting cables NEBA, straight						
	Electrical connection 1, connection technology	Electrical connection 2, connection technology	Electrical connection 2, number of pins/cores	Cable length	Part no.	Type
	M8x1 A-coded to EN 61076-2-104	Open end	3	2.5 m	8078223	NEBA-M8G3-U-2.5-N-LE3
				5 m	8078224	NEBA-M8G3-U-5-N-LE3

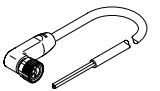
Connecting cables NEBA, angled						
	Electrical connection 1, connection technology	Electrical connection 2, connection technology	Electrical connection 2, number of pins/cores	Cable length	Part no.	Type
	M8x1 A-coded to EN 61076-2-104	Open end	3	2.5 m	8078230	NEBA-M8W3-U-2.5-N-LE3
				5 m	8078231	NEBA-M8W3-U-5-N-LE3

Accessories

Position transmitter

The position transmitter continuously senses the position of the piston.

It has an analogue output with an output signal that is proportional to the piston position.

Ordering data – Position transmitter for T-slot

Datasheets → Internet: sdas

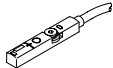
Position measuring range	Description	Type of mounting	Electrical connection	Cable length [m]	Part no.	Type
 ≤ 52	Choice of two operating modes: • two adjustable switching outputs • IO-Link®	Inserted in the slot from above	Plug M8x1, 4-pin, in-line	0.3	8063974	SDAS-MHS-M40-1L-PNLK-PN-E-0.3-M8

Ordering data – Position transmitter for T-slot

Datasheets → Internet: sdat

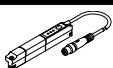
Position measuring range	Analogue output		Type of mounting	Electrical connection	Cable length [m]	Part no.	Type
	[V]	[mA]					
	0 ... 50	–	Inserted in the slot from above	Plug M8x1, 4-pin, in-line	0.3	1531265	SDAT-MHS-M50-1L-SA-E-0.3-M8
	0 ... 80					1531266	SDAT-MHS-M80-1L-SA-E-0.3-M8
	0 ... 100					1531267	SDAT-MHS-M100-1L-SA-E-0.3-M8
	0 ... 125					1531268	SDAT-MHS-M125-1L-SA-E-0.3-M8
	0 ... 160					1531269	SDAT-MHS-M160-1L-SA-E-0.3-M8

Ordering data – Position transmitter for T-slot

Datasheets → Internet: smat

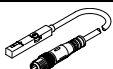
Position measuring range	Analogue output		Type of mounting	Electrical connection	Cable length [m]	Part no.	Type
	[V]	[mA]					
 0 ... 40	0 ... 10	–	Inserted in the slot from above	Plug M8x1, 4-pin, in-line	0.3	553744	SMAT-8M-U-E-0.3-M8D

Ordering data – Mounting kits for position transmitters SDAS/SDAT/SMAT

Datasheets → Internet: smbr

Designation	For Ø	Part no.	Type
Mounting kit SMBR-8			
	8	175091	SMBR-8-8
	10	175092	SMBR-8-10
	12	175093	SMBR-8-12
	16	175094	SMBR-8-16
	20	175095	SMBR-8-20
	25	175096	SMBR-8-25
	32	175097	SMBR-8-32
	40	175098	SMBR-8-40
	50	175099	SMBR-8-50
	63	175100	SMBR-8-63

Accessories

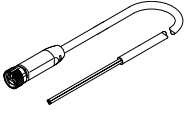
Connecting cables NEBA, straight						
	Electrical connection 1, connection technology	Electrical connection 2, connection technology	Electrical connection 2, number of pins/cores	Cable length	Part no.	Type
	M8x1 A-coded to EN 61076-2-104	Open end	4	2.5 m	8078227	NEBA-M8G4-U-2.5-N-LE4
				5 m	8078228	NEBA-M8G4-U-5-N-LE4

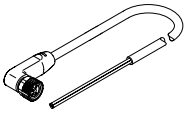
Connecting cables NEBA, angled						
	Electrical connection 1, connection technology	Electrical connection 2, connection technology	Electrical connection 2, number of pins/cores	Cable length	Part no.	Type
	M8x1 A-coded to EN 61076-2-104	Open end	4	2.5 m	8078233	NEBA-M8W4-U-2.5-N-LE4
				5 m	8078234	NEBA-M8W4-U-5-N-LE4

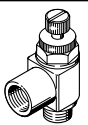
Ordering data – One-way flow control valves					Datasheets → Internet: grl	
	Connection Thread	For tubing O.D.	Material	Part no.	Type	
For supply air						
	M5	3	Metal design	193153	GRLZ-M5-QS-3-D	
		4		193154	GRLZ-M5-QS-4-D	
		6		193155	GRLZ-M5-QS-6-D	
	G1/8	3		193156	GRLZ-1/8-QS-3-D	
		4		193157	GRLZ-1/8-QS-4-D	
		6		193158	GRLZ-1/8-QS-6-D	
		8		193159	GRLZ-1/8-QS-8-D	