

Mini slide unit EGSS

FESTO

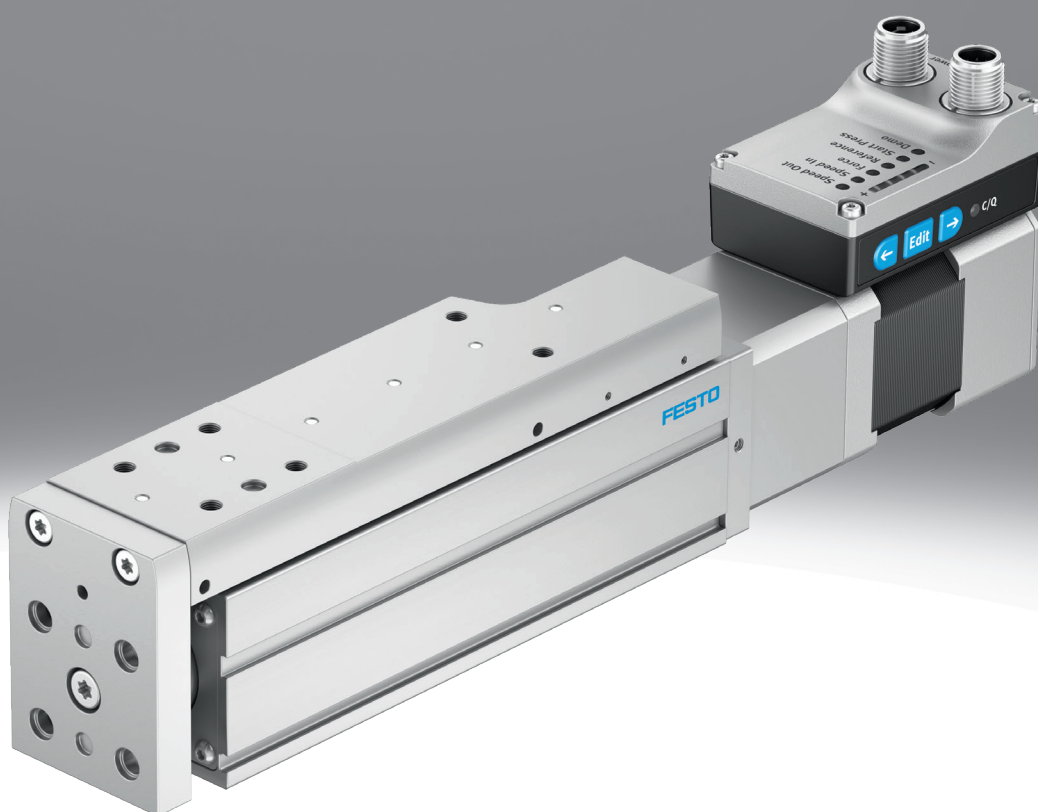

Characteristics

At a glance

Further information → [egss](#)



The simplicity of pneumatics is now combined for the first time with the advantages of electric automation thanks to the Simplified Motion Series. These integrated drives are the perfect solution for users who are looking for an electric alternative for very simple motion and positioning tasks between two mechanical end positions, but don't want the commissioning process for traditional electric drive systems that can often be quite complex.

- No external servo drive: all necessary electronic components combined in the integrated drive
- Two control options integrated as standard: digital I/O and IO-Link®
- Complete solution for simple movements between mechanical end positions
- Simplified commissioning: all parameters can be manually set directly on the drive
- No special knowledge required for commissioning
- Very high-quality ball screw with low internal friction
- Rigid, high load-bearing and precise linear guide for absorbing lateral forces and for increased protection against rotation

Ordering data - modular system

Further information → [egss](#)

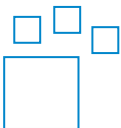

Configurable product

This product and all its product options can be ordered online via the configurator.

Engineering tools

Further information → [engineering tools](#)



Save time with engineering tools Smart Engineering for the optimal solution. Our goal is to increase your productivity. Our engineering tools play an integral part in this. They help you size your system correctly, tap into unimagined productivity reserves and generate additional productivity along the entire value chain. In every phase of your project, from the initial contact to the modernisation of your machine, you will come across a number of different tools which will be of use to you.

Simplified Motion Series - Solution Finder

- Selection tool for simple electric drive solutions from the Simplified Motion Series: This Solution Finder makes finding solutions for electric motion tasks child's play. All you have to do is enter the main application parameters like stroke, payload and motion type, and the system suggests the best solution for your simple motion task in seconds. Then you can simply add it to your shopping basket with just one click and order it online.

Diagrams

Further information → [egss](#)



The diagrams shown in this document are also available online. These can be used to display precise values.

Drive system

[BS] Ball screw drive

- For applications that require precision
- High reliability and long service life
- For large loads

Characteristics

Guide

- Very sturdy and precise guiding principle for transmitting the drive force and moving additional loads
- The guide can easily absorb high torques and forces

Spindle pitch

The spindle pitch describes the distance travelled by the spindle nut per revolution of the spindle in millimetres.

Motor type

IO-Link

- The motor is integrated into the drive and can be easily commissioned according to the “plug and work” principle. The relevant parameters can be set directly on the drive. Control is via digital I/O or IO-Link.
- The service life of the motor at nominal power is 20000 h.

Control panel

When aligning the motor, make sure that the buttons (for parameterisation and control) can be used.

[H1] Integrated

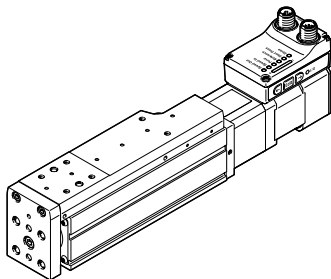

Bus protocol/activation

PNP or NPN switching outputs can be selected for actuation.

End-position sensing

End position feedback similar to a conventional proximity switch, integrated as standard

Cable outlet direction

Describes the alignment of the motor on the drive. Depending on the alignment, the connecting cables can be routed according to the customer's specifications. The cables are positioned at a 45° angle to the axis.

[] Standard

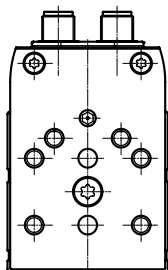

[D] Underneath

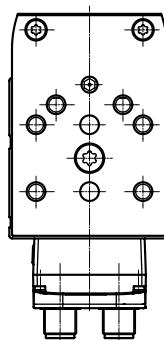

Characteristics

[L] Left

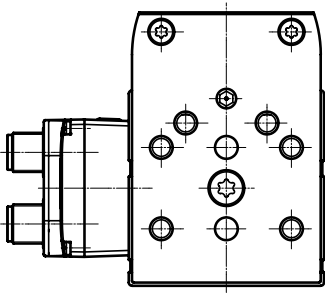

[R] Right

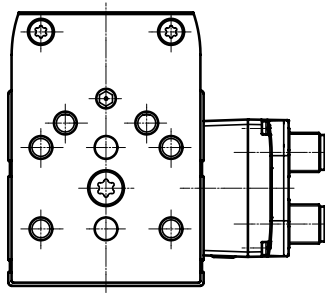

Motor attachment position

[] Standard

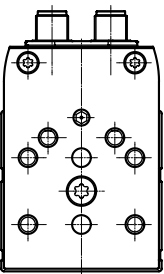

[PL] Parallel, left

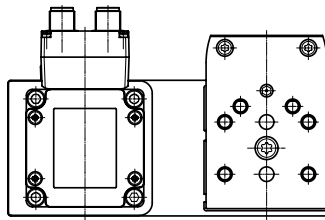

[PR] Parallel, right

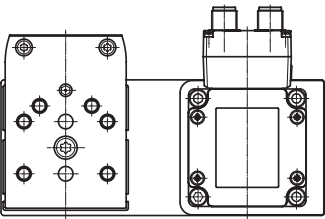

[PD] Parallel, bottom

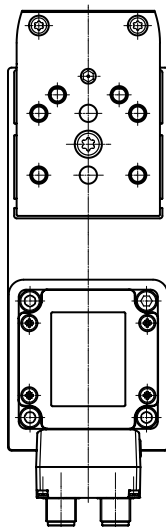

Characteristics

[PT] Parallel, top

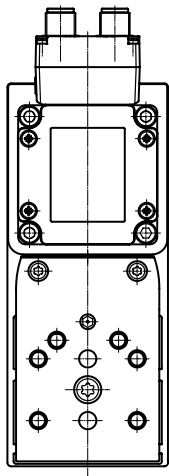

Electrical accessories

Connecting cable between the motor and IO-Link master

Overview

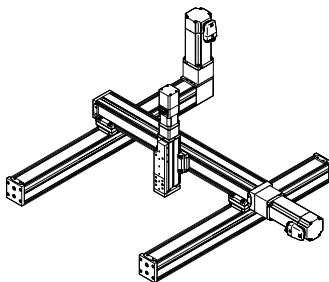

- From the individual axis to the handling system, such as a cantilever system, planar surface gantry or three-dimensional gantry
- The toothed belt and spindle axes ELGC and mini slides EGSC form a scalable modular system for compact automation systems
- The common platform architecture provides an integrated range with matching interfaces. A large number of systems can be implemented completely without adapter plates
- High-performance drive and guide elements ensure a long service life as well as excellent load-bearing capacity and reliability
- The uniform and universal range of accessories reduces warehousing and design costs

Type code

001	Series	
EGSS	Electric slide drive	
002	Drive system	
BS	Ball screw drive	
003	Guide	
KF	Recirculating ball bearing guide	
004	Size	
32	32	
45	45	
60	60	
005	Stroke [mm]	
25	25	
50	50	
75	75	
100	100	
125	125	
150	150	
200	200	
006	Spindle pitch	
8P	8 mm	
10P	10 mm	
12P	12 mm	
007	Motor type	
ST	Stepper motor ST	

008	Controller	
M	Integrated	
009	Control panel	
H1	Integrated	
010	Bus protocol/activation	
PLK	PNP and IO-Link®	
NLK	NPN and IO-Link®	
011	End-position sensing	
AA	With integrated end-position sensing	
012	Cable outlet direction	
	Standard	
D	Underneath	
L	Left	
R	Right	
013	Motor attachment position	
	Standard	
PL	Parallel, left	
PR	Parallel, right	
PD	Parallel, bottom	
PT	Parallel, top	
014	Electrical accessories	
	None	
L1	Adapter for operation as IO-Link® device	

Datasheet

General technical data			
Size	32	45	60
Design	Electric mini slide, With ball screw drive, With integrated drive		
Guide	Recirculating ball bearing guide		
Type of motor	Stepper motor		
Working stroke	25 mm; 50 mm; 75 mm; 100 mm	25 mm; 50 mm; 75 mm; 100 mm; 125 mm; 150 mm	50 mm; 75 mm; 100 mm; 125 mm; 150 mm; 200 mm
Stroke reserve	0 mm		
Additional functions	User interface Built-in end-position sensing		
Display	LED		
Referencing	Positive fixed stop block Negative fixed stop block		
Type of mounting	Via female thread Via centring sleeve With accessories Via cylindrical pin		
Mounting position	optional		
Max. cable length	15 m outputs 15 m inputs 20 m with IO-Link® operation		

Mechanical data			
Size	32	45	60
Reference value effective load, horizontal	2 kg	6 kg	10 kg
Reference value effective load, vertical	2 kg	6 kg	10 kg
Max. feed force F _x	60 N	120 N	250 N
Max. radial force at drive shaft	140 N	340 N	420 N
Max. speed ¹⁾	0.19 m/s	0.235 m/s; 0.25 m/s	0.205 m/s; 0.24 m/s
Speed "Speed press"	0.01 m/s		
Max. acceleration ²⁾	3 m/s ² ; 5 m/s ²		
Repetition accuracy	±0.015 mm		
Reversing backlash theoretical	150 µm		
Position detection	Motor encoder, Via proximity switch		

1) Adjustable in steps of 10%.

Rotational speed and speed are stroke-dependent.

For parallel motor mounting / for axial motor mounting

2) Parameter cannot be changed.

For parallel motor mounting / for axial motor mounting

Spindle			
Size	32	45	60
Spindle diameter	8 mm	10 mm	12 mm
Spindle pitch	8 mm/U	10 mm/U	12 mm/U

Electrical data			
Size	32	45	60
Nominal voltage DC	24 V		
Permissible voltage fluctuations	+/- 15%		
Nominal current	3 A	5.3 A	
Max. current consumption	3 A	5.3 A	
Max. current consumption, logic	300 mA		
Rotor position sensor	Absolute single-turn encoder		
Rotor position sensor, encoder measuring principle	Magnetic		
Rotor position transducer resolution	16 bit		

Datasheet

Interfaces			
Size	32	45	60
Parameterisation interface	IO-Link, User interface		
Working range of logic input	24 V		
Number of digital logic inputs	2		
Features of logic input	Configurable Not galvanically isolated		
Switching logic for inputs	NPN (negative switching) PNP (positive switching)		
Specification logic input	Based on IEC 61131-2, type 1		
Max. current digital logic outputs	100 mA		
Number of digital logic outputs 24 V DC	2		
Features of digital logic outputs	Configurable Not galvanically isolated		
Switching logic for outputs	NPN (negative switching) PNP (positive switching)		

Technical data IO-Link®			
Size	32	45	60
IO-Link, SIO-Mode support	Yes		
IO-Link, communication mode	COM3 (230.4 kBaud)		
IO-Link, Port class	A		
IO-Link, Number of ports	1		
IO-Link, Process data length OUT	2 bytes		
IO-Link, Process data content OUT	1-bit (quit error) 1-bit (move in) 1-bit (move out) 1 bit (move intermediate)	1-bit (move in) 1-bit (quit error) 1-bit (move out) 1 bit (move intermediate)	1-bit (move in) 1-bit (move out) 1-bit (quit error) 1 bit (move intermediate)
IO-Link, Process data length IN	2 bytes		
IO-Link, Process data content IN	1-bit (state device) 1 bit (State Intermediate) 1-bit (state move) 1-bit (state out) 1-bit (state in)	1-bit (state device) 1 bit (State Intermediate) 1-bit (state move) 1-bit (state in) 1-bit (state out)	1-bit (state device) 1-bit (state out) 1 bit (State Intermediate) 1-bit (state move) 1-bit (state in)
IO-Link, Service data IN	32-bit force 32-bit position 32-bit speed		
IO-Link, Min. cycle time	1 ms		
IO-Link, Data storage required	0.5 kB		
IO-Link, Protocol version	Device V 1.1		

Datasheet

Operating and ambient conditions			
Size	32	45	60
Ambient temperature	0 ... 50°C		
Storage temperature	-20 ... 60°C		
Note on ambient temperature	Power must be reduced by 2% per K at ambient temperatures above 30°C.		
Protective function	Temperature monitoring		
Relative air humidity	0 - 90%		
Insulation protection class	B		
Protection class	III		
Degree of protection	IP40		
Duty cycle	100%		
CE mark (see declaration of conformity) ¹⁾	To EU EMC Directive In accordance with EU RoHS Directive		
CE marking (see declaration of conformity) ²⁾	To UK RoHS instructions To UK instructions for EMC		
KC mark	KC-EMV		
Approval	RCM trademark		
Vibration resistance	Transport application test with severity level 1 to FN 942017-4 and EN 60068-2-6		
Shock resistance	Shock test with severity level 1 to FN 942017-5 and EN 60068-2-27		
Cleanroom class	Class 9 according to ISO 14644-1		
Maintenance interval	Life-time lubrication		

1) Further information www.festo.com/catalogue/... → Support/Downloads.

2) Further information www.festo.com/catalogue/... → Support/Downloads.

Weight			
Size	32	45	60
Basic weight for 0 mm stroke ¹⁾	924 g	1,238 g	2,735 g
Additional weight per 10 mm stroke	30 g	63 g	95 g
Moving mass for 0 mm stroke	149 g	212 g	675 g
Additional moving mass per 10 mm stroke	12 g	30 g	40 g

1) For axial motor mounting / for parallel motor mounting

Materials			
Size	32	45	60
Material housing	Anodised wrought aluminium alloy		
Material piston rod	High-alloy stainless steel		
Material slide	Anodised wrought aluminium alloy		
Material guide rail	Rolled steel		
Material spindle	Rolled steel		
Material spindle nut	Rolled steel		
LABS (PWIS) conformity	VDMA24364 zone III		
Note on materials	RoHS-compliant		

Datasheet

Permissible forces and torques for the guide calculation for a service life of 5×10^6 cycles and max. stroke

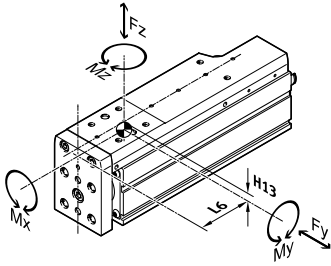

The indicated forces and torques refer to the centre of the guide. The point of application is the intersection of the centre of the guide and the centre of the length of the slide. They must not be exceeded in dynamic operation. Special attention must be paid to the deceleration process.

Distance to the centre of the guide:

Size 32/45/60

Dimension H13: 7.9 mm/10.2 mm/15.9 mm

Dimension L6: 31.8 mm/37.3 mm/53.4 mm

Size	32	45	60
Max. force F_y	991 N	1,314 N	4,937 N
Max. force F_z	991 N	1,314 N	4,937 N
Max. moment M_x	3.4 Nm	8.14 Nm	20 Nm
Max. moment M_y	3.17 Nm	7.05 Nm	30 Nm
Max. moment M_z	3.17 Nm	7.05 Nm	30 Nm

Basic load ratings

Size	32	45	60
Dynamic basic load rating ball screw	2,000 N	3,200 N	4,600 N
Dynamic basic load rating linear guide	2,135 N	3,240 N	13,400 N
Dynamic basic load rating fixed bearing	3,795 N	7,413 N	13,321 N
Static basic load rating ball screw	3,700 N	5,900 N	8,500 N
Static basic load rating linear guide	3,880 N	5,630 N	26,900 N
Static basic load rating fixed bearing	1,792 N	3,966 N	7,000 N

Calculating the load comparison factor

$$f_v = \frac{|F_{y1}|}{F_{y2}} + \frac{|F_{z1}|}{F_{z2}} + \frac{|M_{x1}|}{M_{x2}} + \frac{|M_{y1}|}{M_{y2}} + \frac{|M_{z1}|}{M_{z2}} \leq 1$$

If the axis is simultaneously subjected to several of the indicated forces and torques, the following equation must be satisfied in addition to the indicated maximum loads.

For a guide system to have a service life of 5×10^6 cycles, the load comparison factor must have a value of $f_v < 1$, based on the maximum permissible forces and torques for a service life of 5×10^6 cycles. This formula can be used to calculate a guide value. The engineering software "Electric Motion Sizing" is available for more precise calculations.

F_1 / M_1 = dynamic value

F_2 / M_2 = maximum value

Calculating the service life of the guide

The service life of the guide depends on the load. To be able to provide a rough indication of the service life of the guide, the graph below plots the load comparison factor f_v against the service life.

These values are only theoretical. You must consult your local Festo contact for a load comparison factor f_v greater than 1.

Datasheet

Load comparison factor f_v as a function of service life l

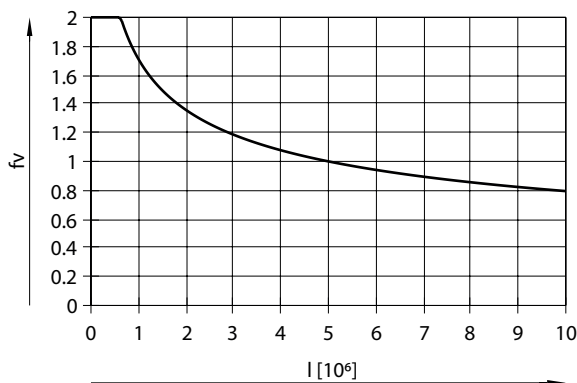

Example:

A user wants to move a X kg load. The calculation gives a value of 1.5 for the load comparison factor f_v . According to the graph, the guide would have a service life of approx. 1.5×10^6 cycles. Reducing the acceleration reduces the M_z and M_y values. A load comparison factor f_v of 1 now gives a service life of 5×10^6 cycles.

Permissible forces and torques at a theoretical service life of 100 km (pure guide load)

The characteristic load values of the bearing guides are standardised to ISO and JIS using dynamic and static forces and torques. These forces and torques are based on an expected service life of the guide system of 100 km to ISO or 50 km to JIS. As the characteristic load values are dependent on the service life, the maximum permissible forces and torques for a 5000 km service life cannot be compared with the dynamic forces and torques of roller guides to ISO/JIS.

To make it easier to compare the guide capacity of linear axes ELGC with bearing guides, the table below lists the theoretically permissible forces and torques for a calculated service life of 100 km. This corresponds to the dynamic forces and moments to ISO. These 100 km values have been calculated mathematically and are only to be used for comparing with dynamic forces and torques to ISO. The drives must not be loaded with these characteristic values as this could damage the axes.

Size	32	45	60
F_y at theoretical life value of 100 km (only guide consideration)	2,135 N	3,240 N	13,400 N
F_z at theoretical life value of 100 km (only guide consideration)	2,135 N	3,240 N	13,400 N
M_x at theoretical life value of 100 km (only guide consideration)	10 Nm	20 Nm	107 Nm
M_y at theoretical life value of 100 km (only guide consideration)	7 Nm	17 Nm	117 Nm
M_z at theoretical life value of 100 km (only guide consideration)	7 Nm	17 Nm	117 Nm

Datasheet

Sizing example

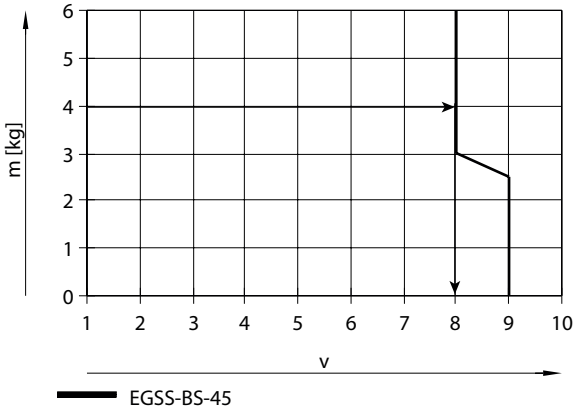

Application data:

- Payload: 4 kg
- Mounting position: vertical
- Motor mounting position: axial
- Stroke: 100 mm
- Max. permissible positioning time: 1 s (one direction)

Step 1:

Smallest possible size from the table “Mechanical data”: EGSS-BS-KF-45

Step 2:

Selecting the max. speed level v for payload m (see diagram on the left)

Step 3:

Reading off the min. positioning time t for stroke l (see diagram on the left)

Result: the application can be realised with EGSS-BS-KF-45-100. A minimum positioning time (one direction) of 0.6 s is achieved.

Longer positioning times can be selected at any time by using a lower speed setting.

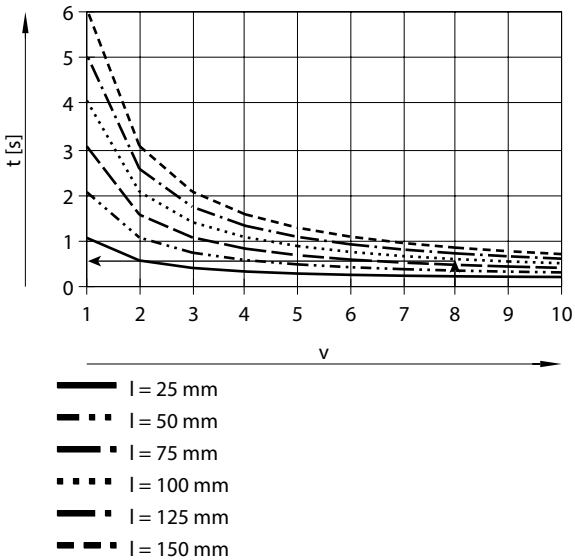

Mass m as a function of speed level v , with axial kit, horizontal mounting position for EGSS-BS-32

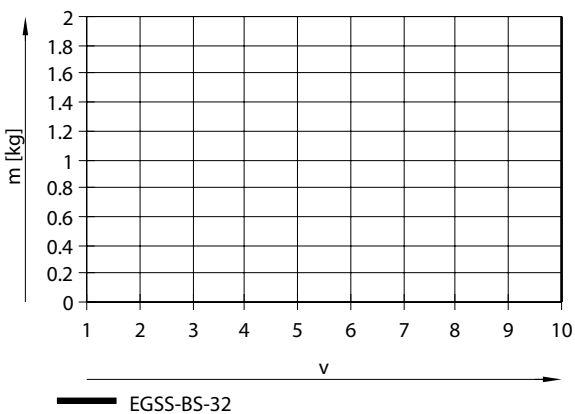

Note:

The lines represent the maximum values. The lower speed settings can be set at any time.

Datasheet

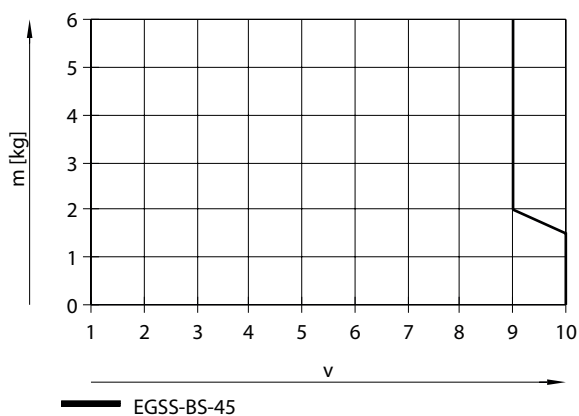
Mass m as a function of speed level v , with axial kit, horizontal mounting position for EGSS-BS-45

Note:

The lines represent the maximum values. The lower speed settings can be set at any time.

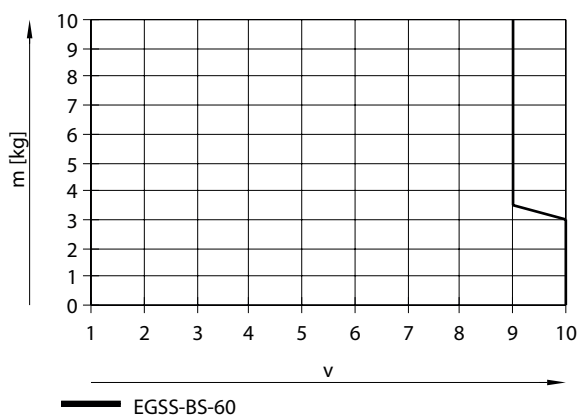
Mass m as a function of speed level v , with axial kit, horizontal mounting position for EGSS-BS-60

Note:

The lines represent the maximum values. The lower speed settings can be set at any time.

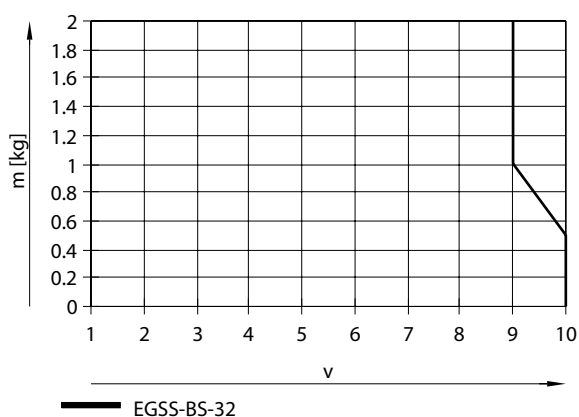
Mass m as a function of speed level v with axial kit, vertical mounting position for EGSS-BS-32

Note:

The lines represent the maximum values. The lower speed settings can be set at any time.

Datasheet

Mass m as a function of speed level v with axial kit, vertical mounting position for EGSS-BS-45

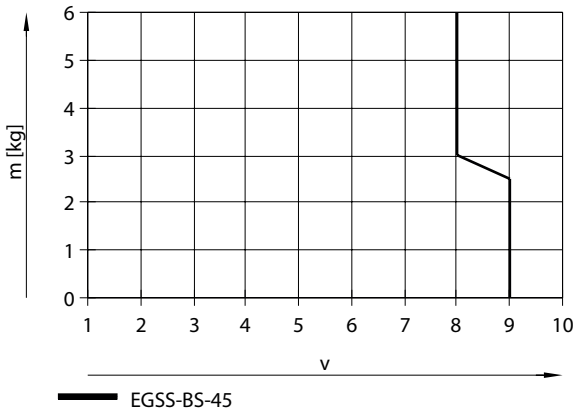

Note:

The lines represent the maximum values. The lower speed settings can be set at any time.

Mass m as a function of speed level v with axial kit, vertical mounting position for EGSS-BS-60

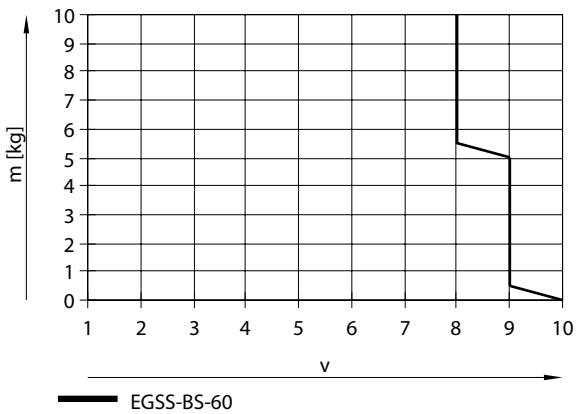

Note:

The lines represent the maximum values. The lower speed settings can be set at any time.

Mass m as a function of speed level v with parallel kit, horizontal mounting position for EGSS-BS-32

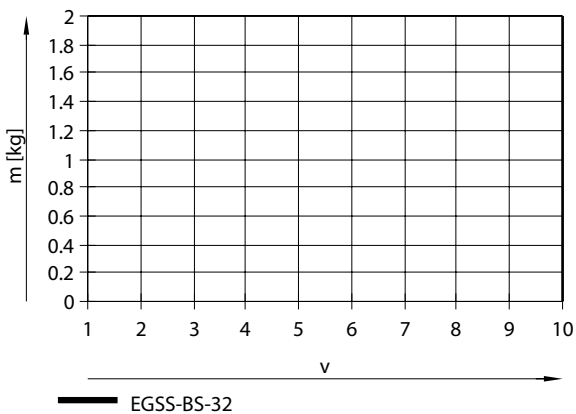

Note:

The lines represent the maximum values. The lower speed settings can be set at any time.

Datasheet

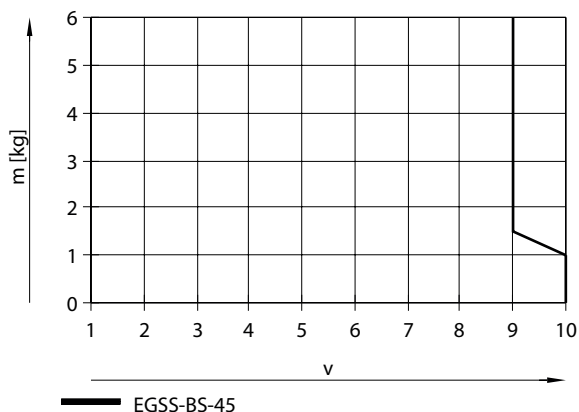
Mass m as a function of speed level v with parallel kit, horizontal mounting position for EGSS-BS-45

Note:

The lines represent the maximum values. The lower speed settings can be set at any time.

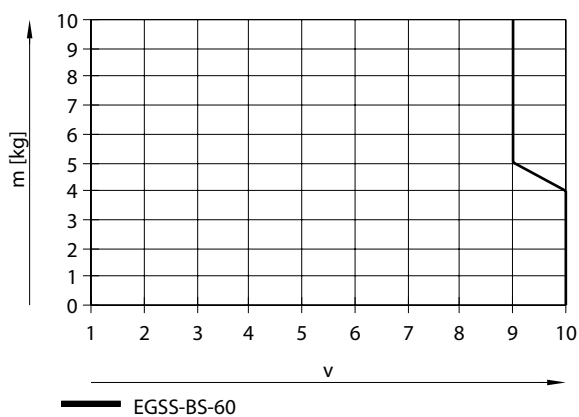
Mass m as a function of speed level v with parallel kit, horizontal mounting position for EGSS-BS-60

Note:

The lines represent the maximum values. The lower speed settings can be set at any time.

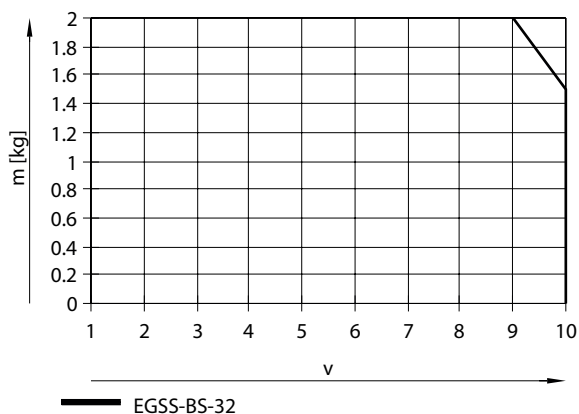
Mass m as a function of speed level v with parallel kit, vertical mounting position for EGSS-BS-32

Note:

The lines represent the maximum values. The lower speed settings can be set at any time.

Datasheet

Mass m as a function of speed level v with parallel kit, vertical mounting position for EGSS-BS-45

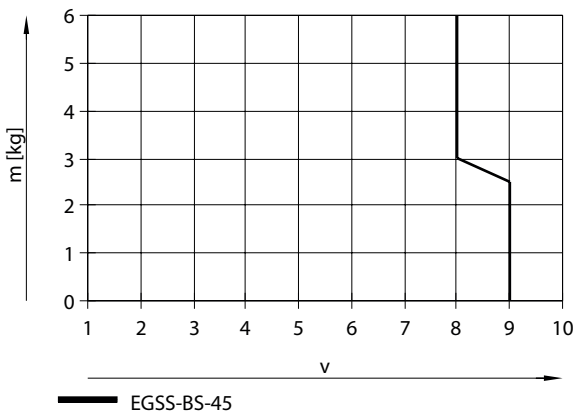

Note:
The lines represent the maximum values. The lower speed settings can be set at any time.

Mass m as a function of speed level v with parallel kit, vertical mounting position for EGSS-BS-60

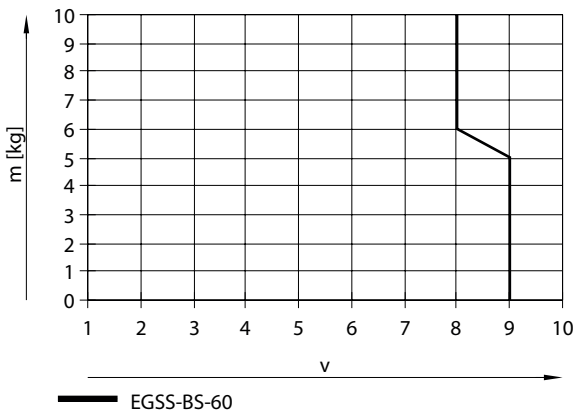

Note:
The lines represent the maximum values. The lower speed settings can be set at any time.

Positioning time t as a function of speed level v and stroke l with axial kit for EGSS-BS-32

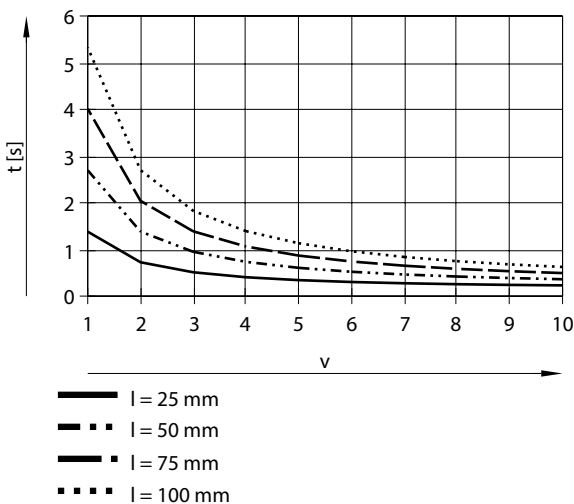

Datasheet

Positioning time t as a function of speed level v and stroke l with axial kit for EGSS-BS-45

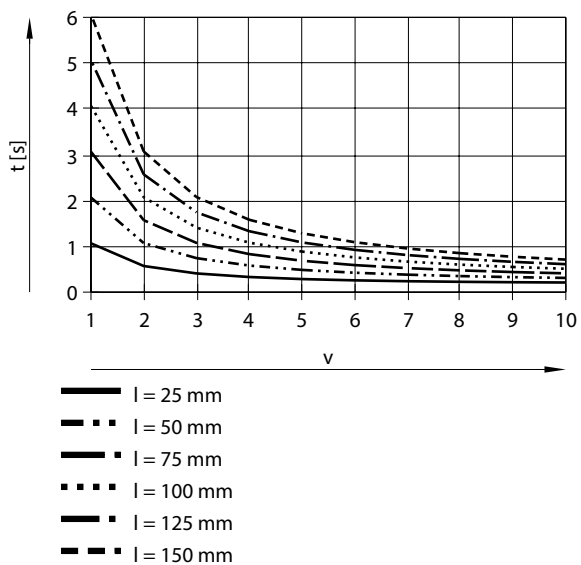

Positioning time t as a function of speed level v and stroke l with axial kit for EGSS-BS-60

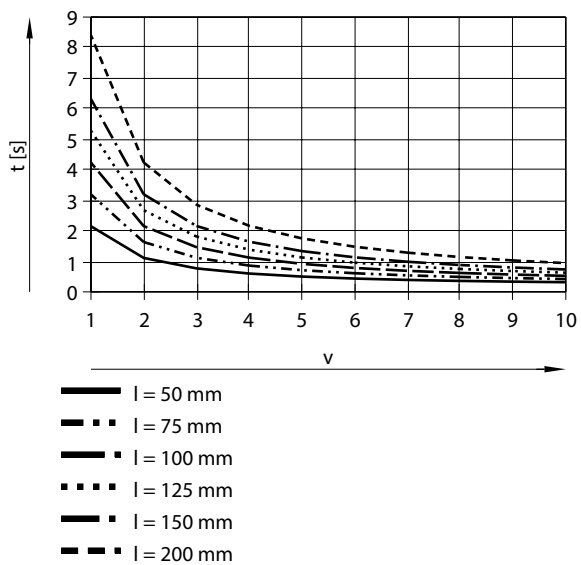

Datasheet

Positioning time t as a function of speed level v and stroke l with parallel kit for EGSS-BS-32

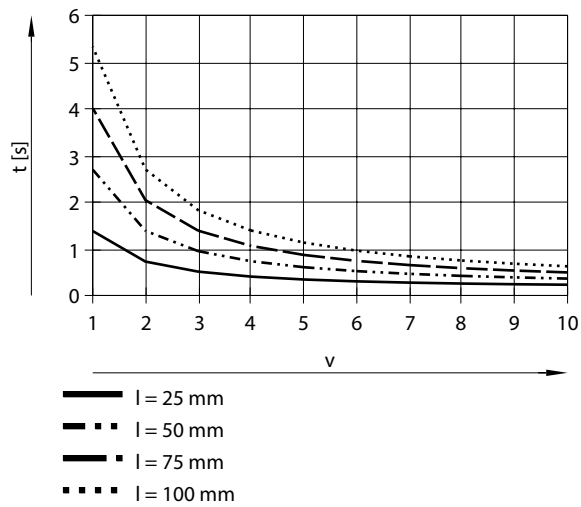

Positioning time t as a function of speed level v and stroke l with parallel kit for EGSS-BS-45

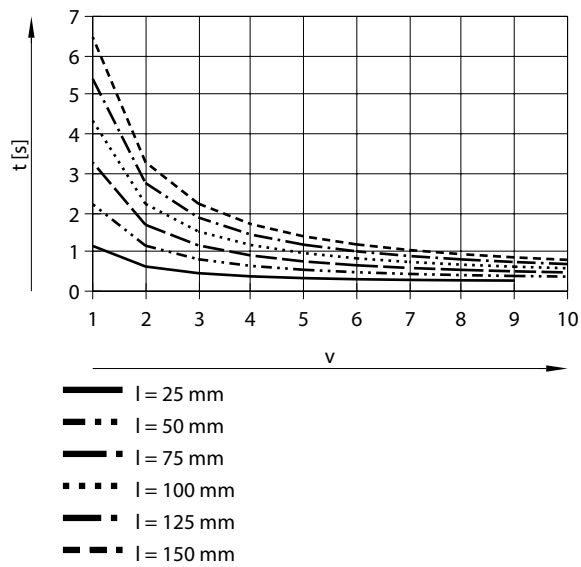

Datasheet

Positioning time t as a function of speed level v and stroke l with parallel kit for EGSS-BS-60

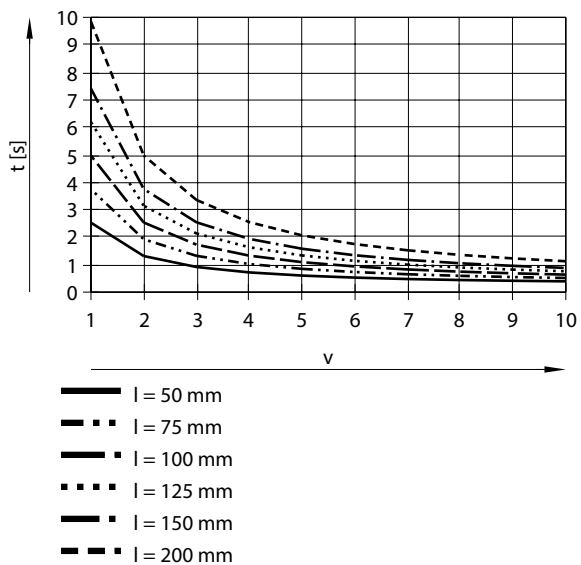

Feed force F as a function of force level F_1

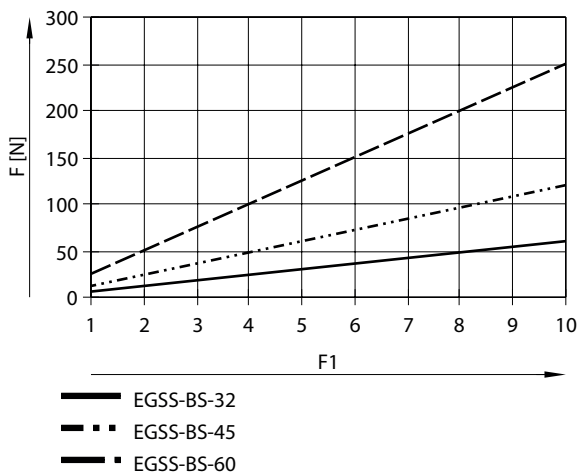

Feed force F as a function of service life l

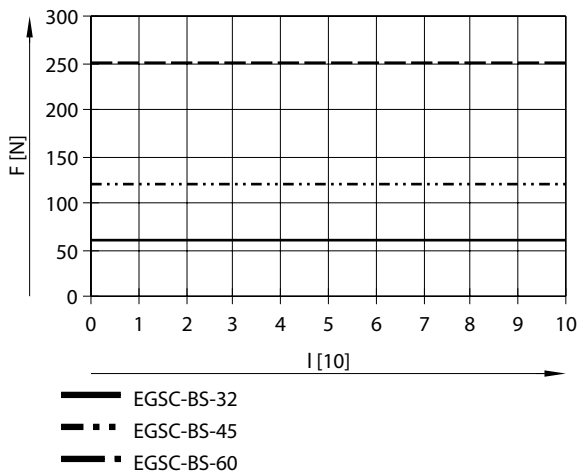

Datasheet

Deflection f on the guide rail as a function of stroke l

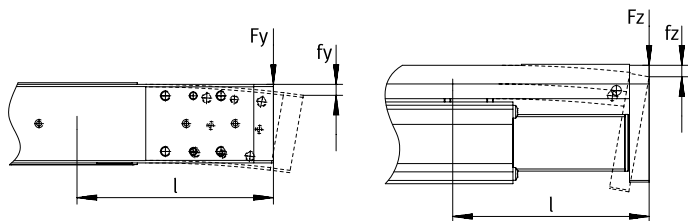

Deflection f_y

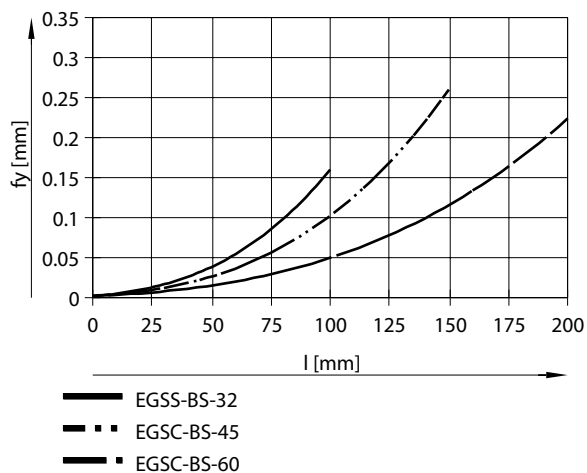

F_y at which the characteristic curves were determined:

EGSS-BS-32: 10 N

EGSS-BS-45: 10 N

EGSS-BS-60: 10 N

Deflection f_z

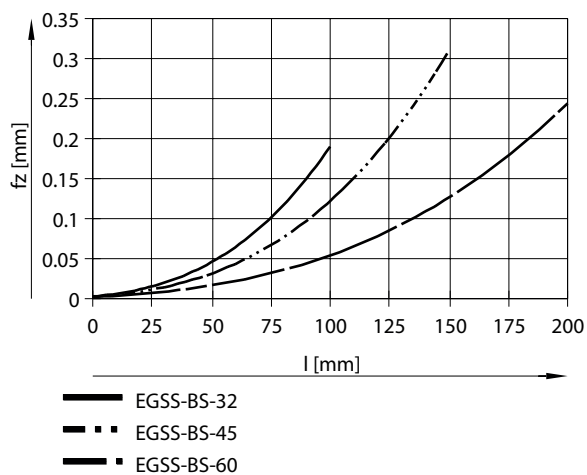

F_z at which the characteristic curves were determined:

EGSS-BS-32: 10 N

EGSS-BS-45: 10 N

EGSS-BS-60: 10 N

Datasheet

Combinations between axis ELGC, ELGS, mini slide EGSC-BS, EGSS-BS, electric cylinder EPCC, EPCS and guide axis ELFC

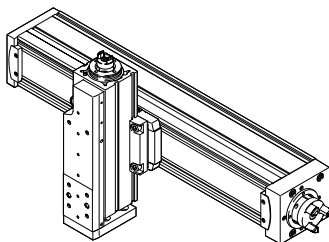

Mounting options with profile mounting EAHF-L2-...-P-D

- Mounting option: base axis with one-size-down assembly axis

1. Base axis:
Product: ELGC, ELGS, ELFC
Size 32, 45, 60, 80
2. Assembly axis:
Product: ELGC, ELGS, EGSC, EGSS, EPCC, EPCS, ELFC
Size 25, 32, 45, 60

Combinations between axis ELGC, ELGS, mini slide EGSC-BS, EGSS-BS, electric cylinder EPCC, EPCS and guide axis ELFC

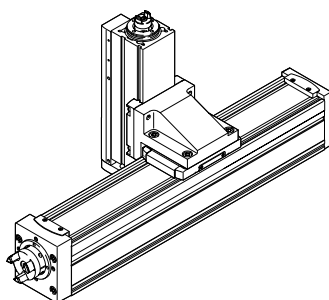

Mounting options with angle kit EHAA-D-L2-...-AP

- Mounting option: base axis with one-size-down assembly axis

1. Base axis:
Product: ELGC, ELGS, ELFC
Size 32, 45, 60, 80
2. Assembly axis:
Product: ELGC, ELGS, EGSC, EGSS, EPCC, EPCS, ELFC
Size 25, 32, 45, 60

Combinations between axis ELGC, ELGS, mini slide EGSC-BS, EGSS-BS, electric cylinder EPCC, EPCS and guide axis ELFC

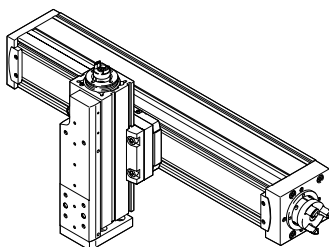

Mounting options with adapter kit EHAA-D-L2

- Mounting option: base axis with same size assembly axis
- Mounting option: base axis with height compensation for one-size-down assembly axis
- When motors are mounted using parallel kits, this may lead to interfering contours. In this case, the adapter plate is required for height compensation

1. Base axis:
Product: ELGC, ELGS, ELFC
Size 32, 45, 60, 80
2. Assembly axis:
Product: ELGC, ELGS, EGSC, EGSS, EPCC, EPCS, ELFC
Size 25, 32, 45, 60, 80

Combinations between mini slides EGSC-BS, EGSS-BS

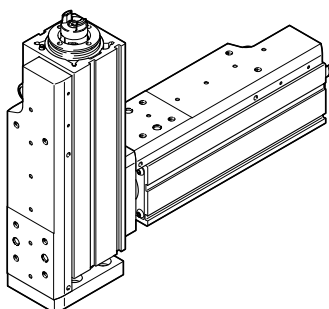

Mounting options with direct mounting

- Mounting option: base axis with same size assembly axis

1. Base axis:
Product: EGSC, EGSS
Size 25, 32, 45, 60
2. Assembly axis:
Product: EGSC, EGSS
Size 25, 32, 45, 60

Dimensions

Dimensions – With axial motor mounting, size 32/45/60

Download CAD data → www.festo.com

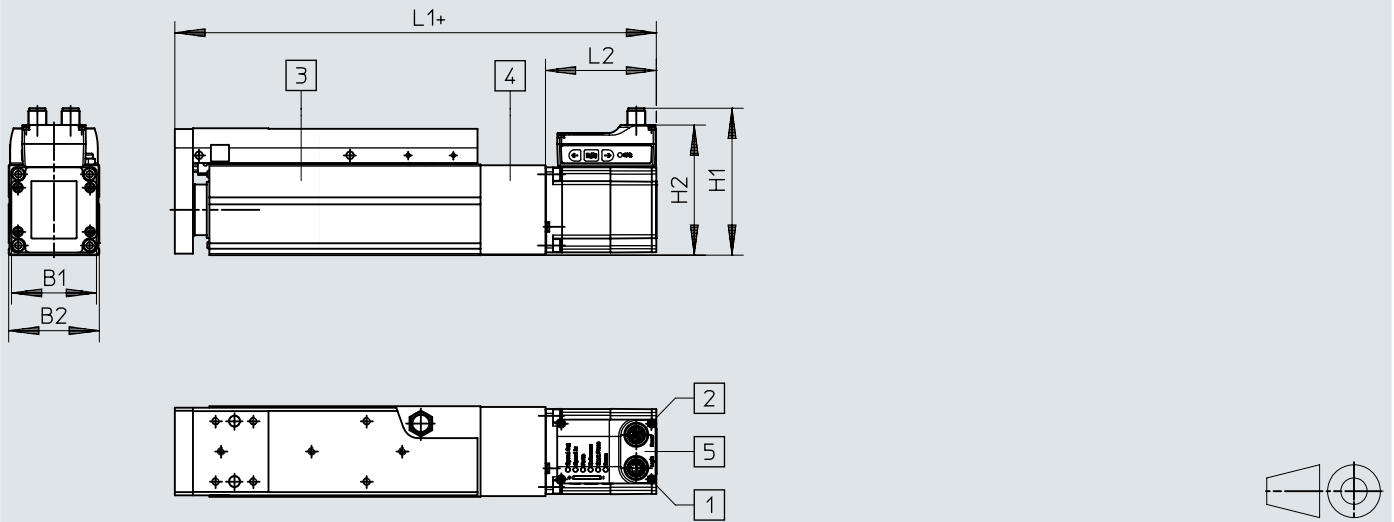

- [1] Connection to logic interface
- [2] Connection to power supply
- [3] Mini slide
- [4] Axial kit
- [5] Motor
- [6] + = plus stroke length

	B1	B2	H1	H2	L1	L2
EGSS-BS-KF-32	42,3	32	81,1	69,9	167	65
EGSS-BS-KF-45	42,3	45	82,6	71,4	178,8	65
EGSS-BS-KF-60	56,6	60	97,3	86,1	218,9	73,5

Dimensions

Dimensions – With parallel motor mounting, size 32/45/60

Download CAD data → www.festo.com

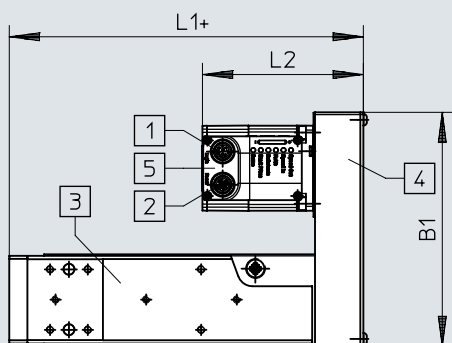
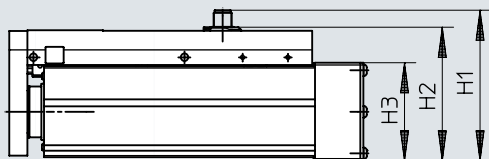

- [1] Connection to logic interface
- [2] Connection to power supply
- [3] Mini slide
- [4] Parallel kit
- [5] Motor
- [6] + = plus stroke length



	B1	H1	H2	H3	L1	L2
EGSS-BS-KF-32	111	83	72	45	86	93
EGSS-BS-KF-45	111	83	72	45	97,8	93
EGSS-BS-KF-60	155	100	90	65	134,4	106,5

Dimensions

Dimensions – Mechanics, size 32/45

Download CAD data → www.festo.com

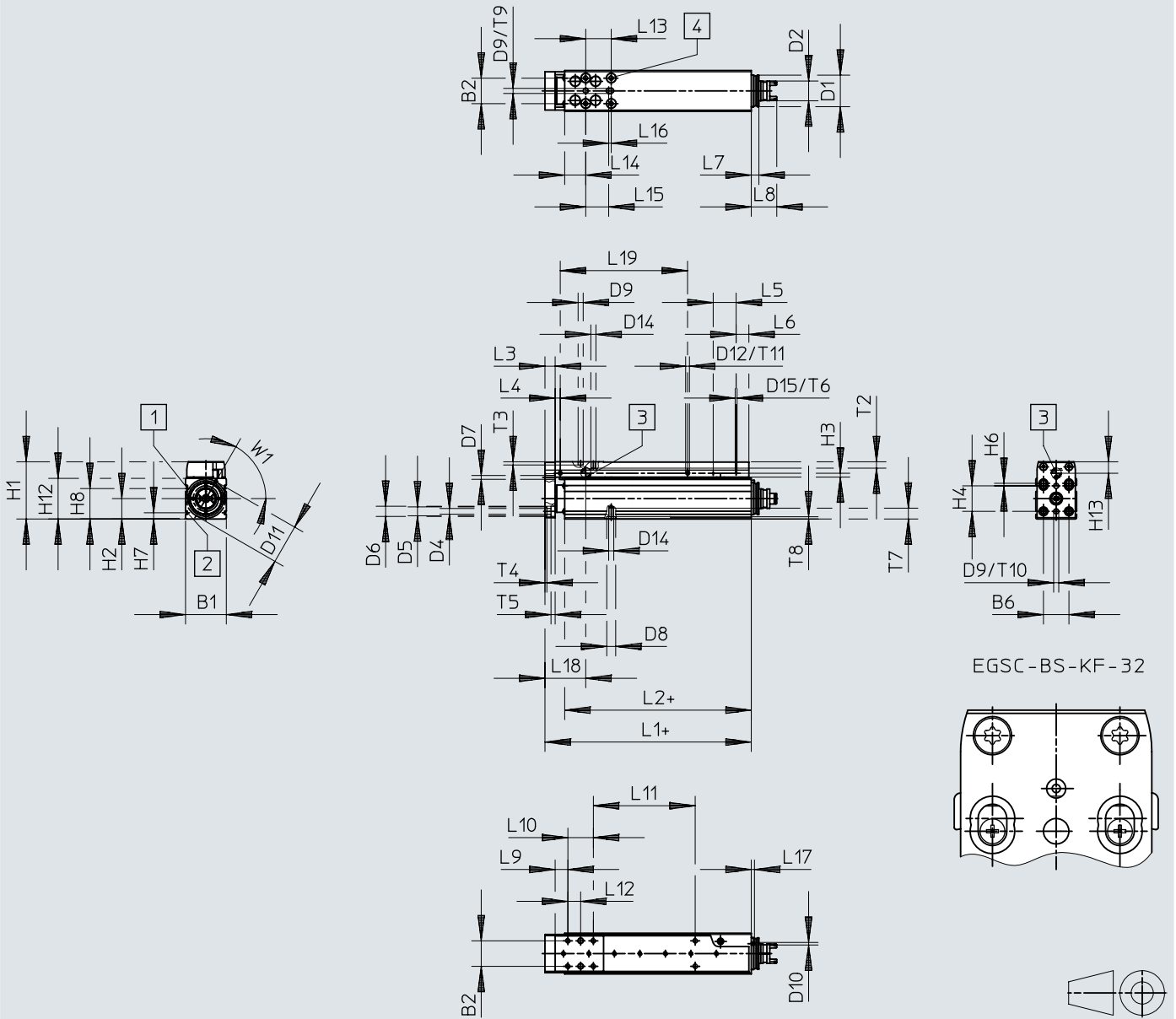

EGSS - BS - KF - 32

- [1] = Slot for sensor bracket
- [2] = Mounting slot
- [3] Guide centre
- [4] Mounting thread sealed on delivery

Dimensions

	B1 ±0,15	B2	B6	D1 ∅	D2 ∅	D4 ∅ H13	D5 ∅ H7	D6 ∅ H13	D7 ∅	D8 ∅ H7	D9 ∅ H8	D10 ∅	D11 ∅	D12 ∅
EGSS-BS-KF-32	32	20	20	25	16,5	4,5	7	8	3	7	4	2	31	3
EGSS-BS-KF-45	45	25	25	32	16,5	5,5	7	10	3	7	5	3	41	3

	D14	D15	H1	H2	H3	H4	H6	H7	H8	H12 ±0,15	H13	L1	L2	L3 +0,2
EGSS-BS-KF-32	M4	M1,6	45	16	3	20	2	4,9	24	32	8,4	62	46,5	8
EGSS-BS-KF-45	M5	M2	60,5	22,5	3	25	–	6,1	28,5	45	10,7	73,8	54,5	10

	L4	L5 ±0,1	L6	L7	L8	L9	L10	L12	L13	L14	L15	L16	L17	L18
EGSS-BS-KF-32	4	18	10	6	19,9	10	20	10	20	16,5	18	2	2,5	31,8
EGSS-BS-KF-45	4	24	12	6	19,9	15	25	12,5	25	17,5	24	2	2	37,3

	T2	T3 +0,1	T4 +0,1	T5	T6	T7	T8	T9 +0,1	T10 +0,1	T11 +0,1	T11 –0,2	W1	≈± 1
EGSS-BS-KF-32	5	2,6	1,6	3,2	1,5	8,5	1,8	2,6	2,6	1,5	–0,2	60°	6
EGSS-BS-KF-45	6	1,3	1,6	5,4	4	7	1,8	1,3	1,3	5	–0,2	60°	12

	L ¹⁾	L19	L11
EGSS-BS-KF-32	25	25	0
	50	50	30
	75	75	55
	100	100	80
EGSS-BS-KF-45	25	25	0
	50	50	25
	75	75	50
	100	100	75
	125	125	100
	150	150	125

1) Stroke

Dimensions

Dimensions – Mechanics, size 60

Download CAD data → www.festo.com

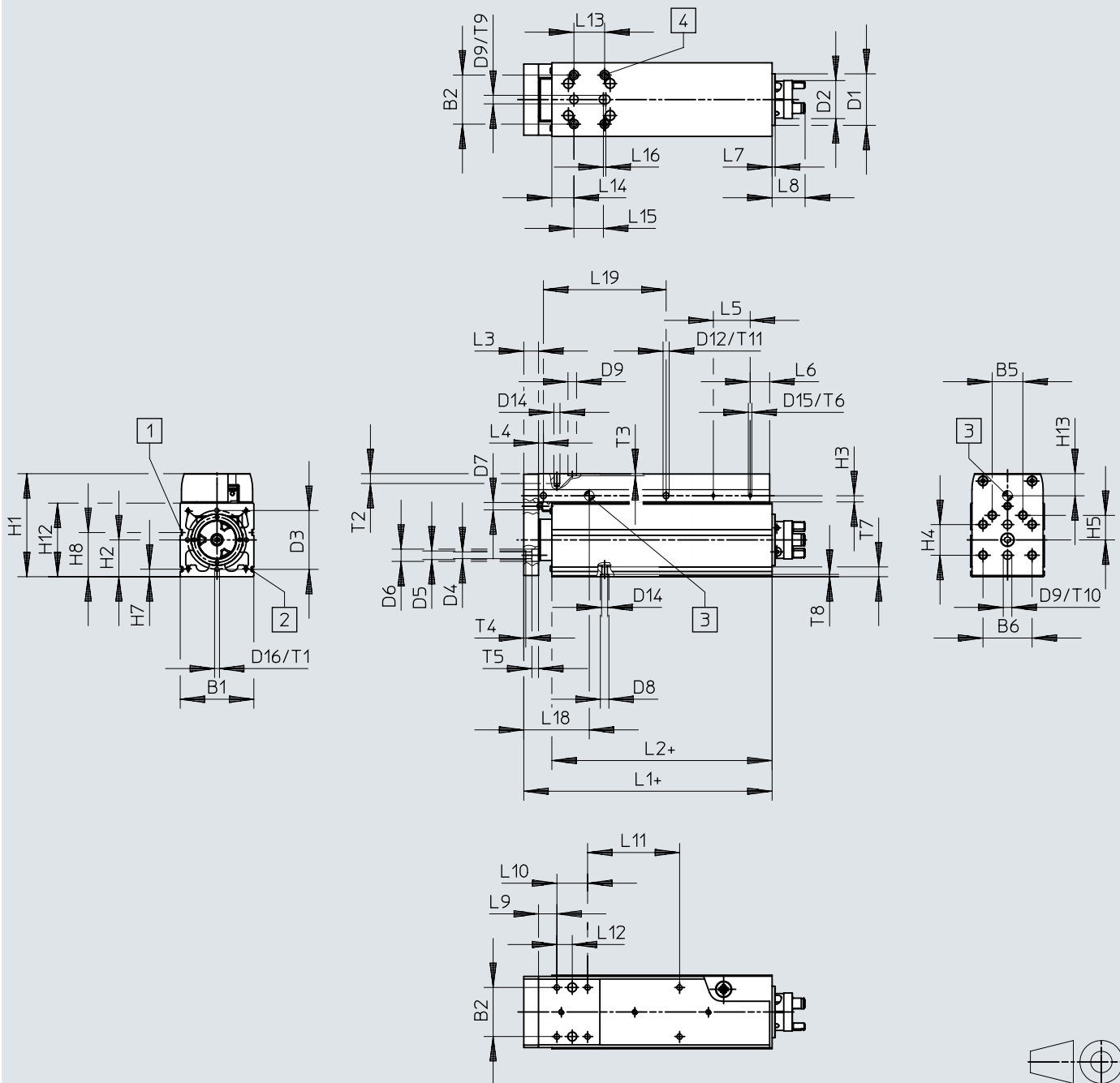

- [1] = Slot for sensor bracket
- [2] = Mounting slot
- [3] Guide centre
- [4] Mounting thread sealed on delivery

Dimensions

	B1 ±0,15	B2	B5	B6	D1 ∅	D2 ∅	D3 ∅	D4 ∅ H13	D5 ∅ H7	D6 ∅ H13	D7 ∅	D8 ∅ H7	D9 ∅ H8
EGSS-BS-KF-60	60	40	25	40	42	31	48	5,5	7	10	6	7	7

	D12 ∅	D13	D14	D15	D16	H1	H2	H3	H4	H5	H7	H8	H12 ±0,15	H13
EGSS-BS-KF-60	5	M4	M5	M3	M4	84	30	5	25	20	6,1	36	60	16,4

	L1	L2	L3 +0,2	L4	L5 ±0,1	L6	L7	L8	L9	L10	L12	L13	L14	L15
EGSS-BS-KF-60	102,4	79,5	12	4	30	16	2,5	26,9	15	25	12,5	25	30	24

	L16	L18	T1	T2	T3 +0,1	T4 +0,1	T5	T6	T7	T8 +0,1	T9 +0,1	T10 +0,1	T11 -0,2	≈1
EGSS-BS-KF-60	2	53,4	10	8	1,6	1,6	5,4	6	8	1,8	1,6	1,6	5	15

	L ¹⁾	L19	L11
EGSS-BS-KF-60	50	50	25
	75	75	50
	100	100	75
	125	125	100
	150	150	125
	200	200	175

1) Stroke

Dimensions

Dimensions – Profile mounting EAHF-L2-...-P-S

Download CAD data → www.festo.com

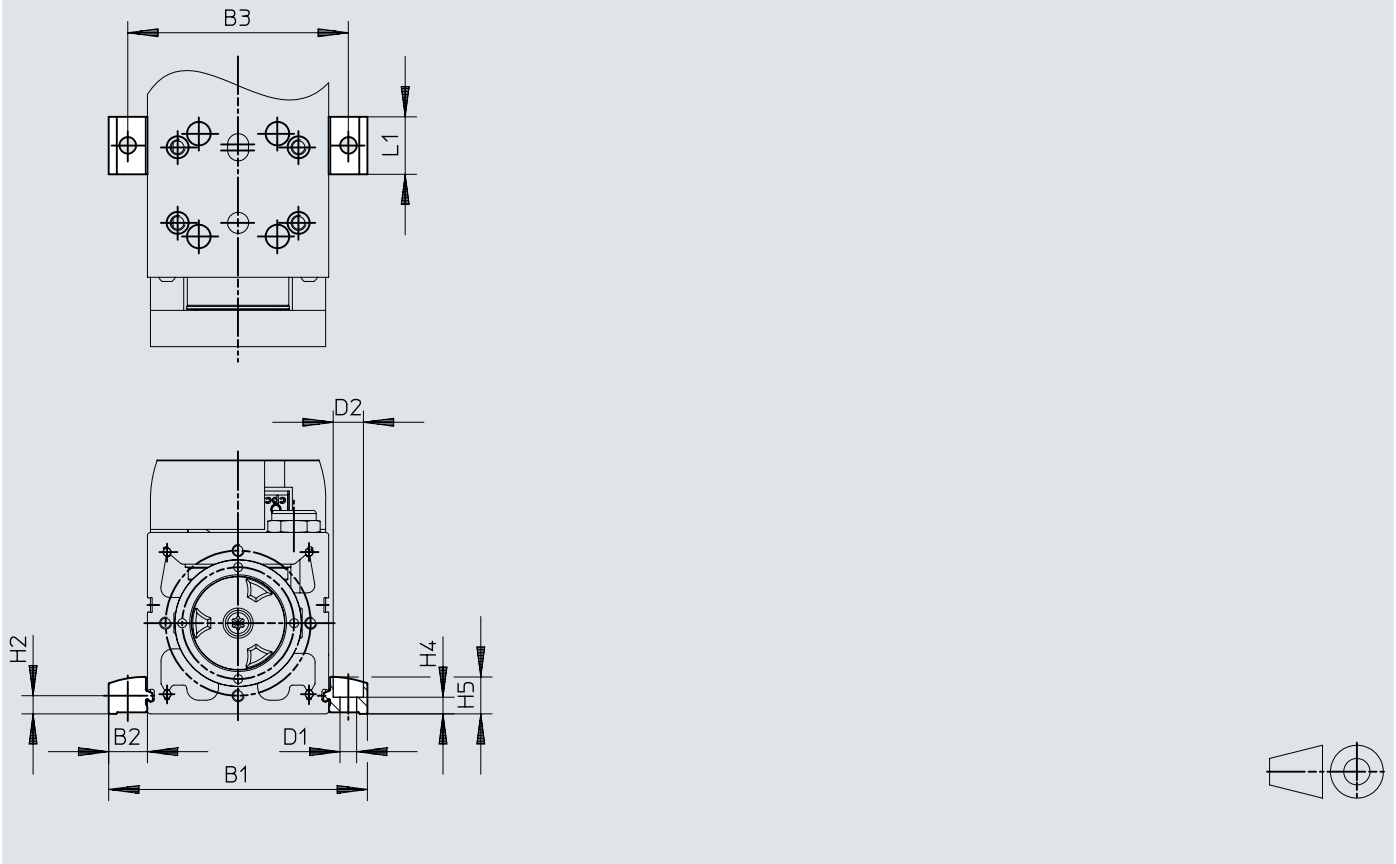

		B1	B2	B3	D1 ∅ H13	D2 ∅ H13	H2	H4 ±0,1	H5	L1
EAHF-L2-25-P-S	EGSS-BS-KF-32	51,4	9,7	42	4,5	8	4,9	4,2	9	19
EAHF-L2-45-P-S	EGSS-BS-KF-45	70,6	12,8	58	5,5	10	6,1	5,5	12,2	19
	EGSS-BS-KF-60	85,6	12,8	73	5,5	10	6,1	5,5	12,2	19

Dimensions

Dimensions – Profile mounting EAHF-L2-...-P

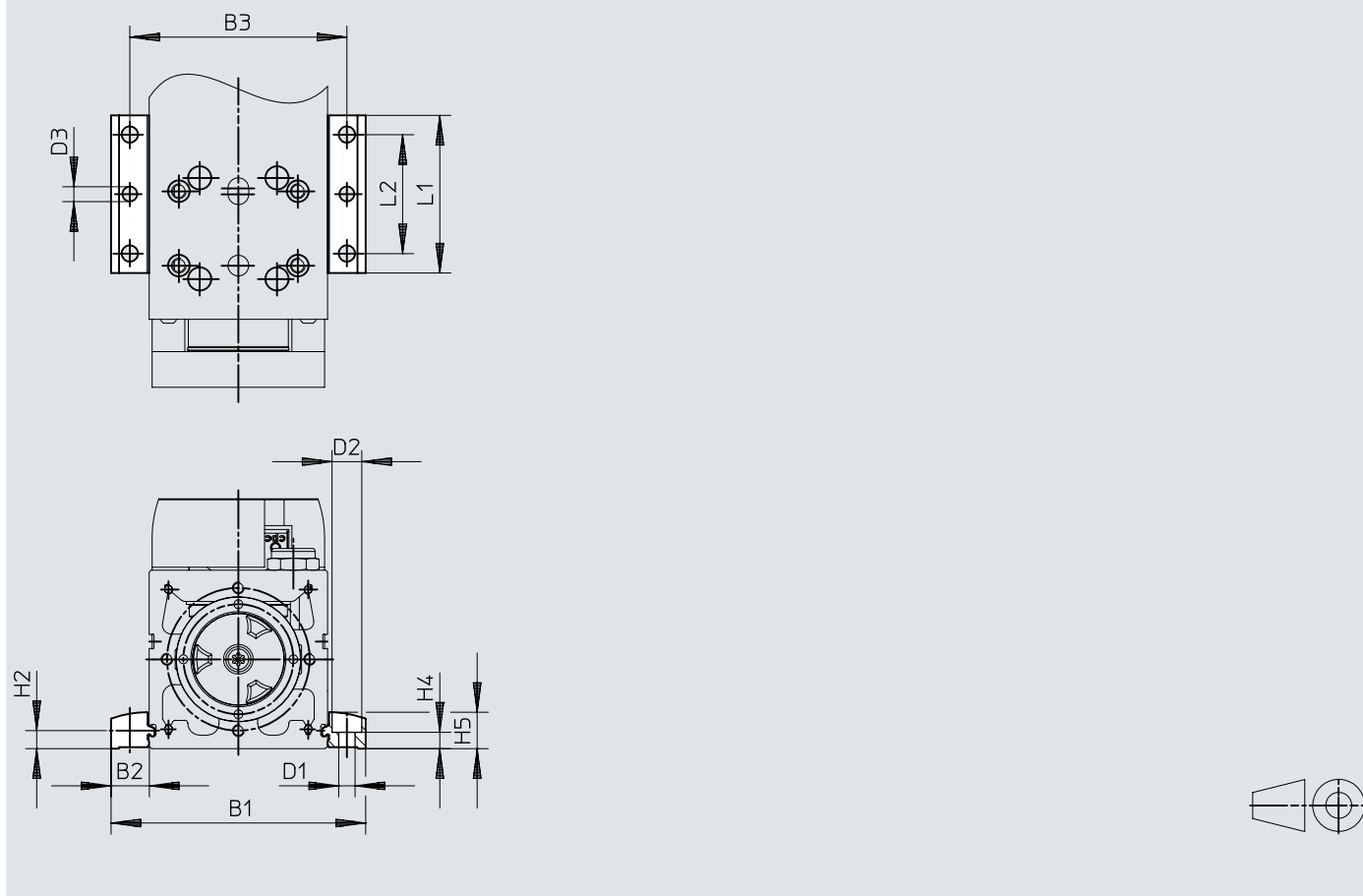
Download CAD data → www.festo.com

		B1	B2	B3	D1 ∅ H13	D2 ∅ H13	D3 ∅	H2	H4 ±0,1	H5	L1	L2
EAHF-L2-25-P	EGSS-BS-KF-32	51,4	9,7	42	4,5	8	4	4,9	4,2	9	53	40
EAHF-L2-45-P	EGSS-BS-KF-45	70,6	12,8	58	5,5	10	5	6,1	5,5	12,2	53	40
	EGSS-BS-KF-60	85,6	12,8	73	5,5	10	5	6,1	5,5	12,2	53	40

Dimensions

Dimensions – Switch lug EAPM-...-SLS

Download CAD data → www.festo.com

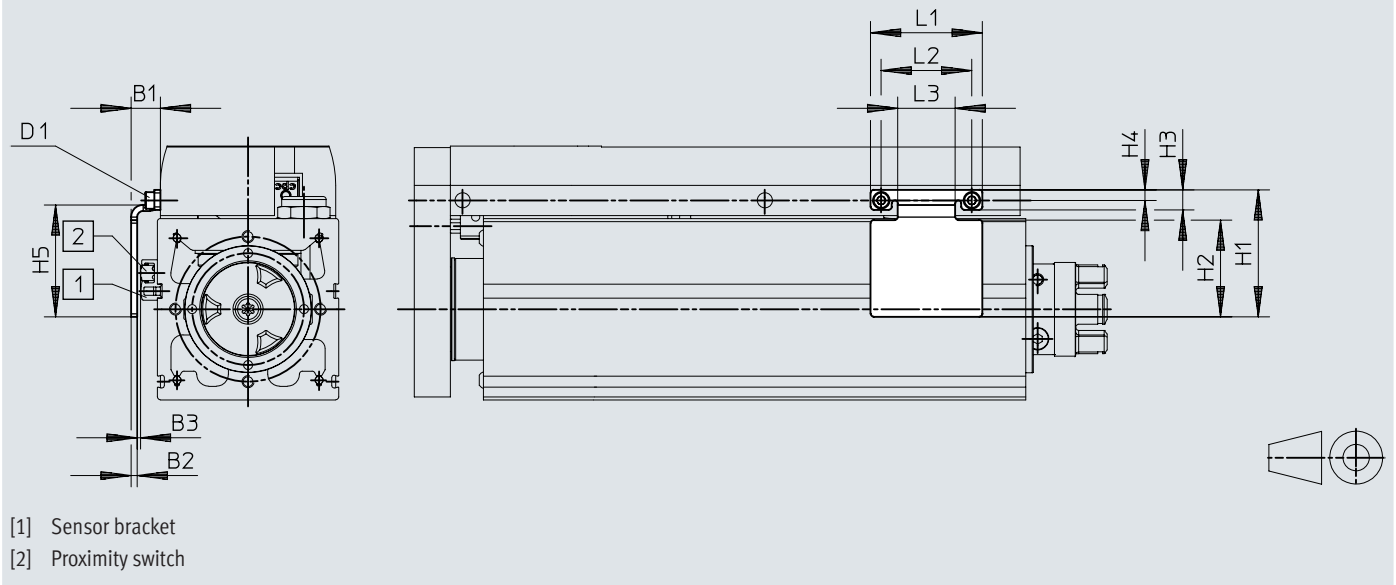

		B1	B2	B3	D1	H1	H2	H3	H4	H5	L1	L2	L3
EAPM-L2-32-SLS	EGSS-BS-KF-32	9,2	2	1,0±0,26	M1,6	27	19	4,3	2,5	24	22	18	10
EAPM-L2-45-SLS	EGSS-BS-KF-45	9,4	2	0,7±0,26	M2	37	28	5,5	3,3	33	30	24	14
EAPM-L2-60-SLS	EGSS-BS-KF-60	9,7	2	0,7±0,31	M3	42	32	6,6	3,5	37	37	30	19

Dimensions

Dimensions – Sensor bracket EAPM-L2

Download CAD data → www.festo.com

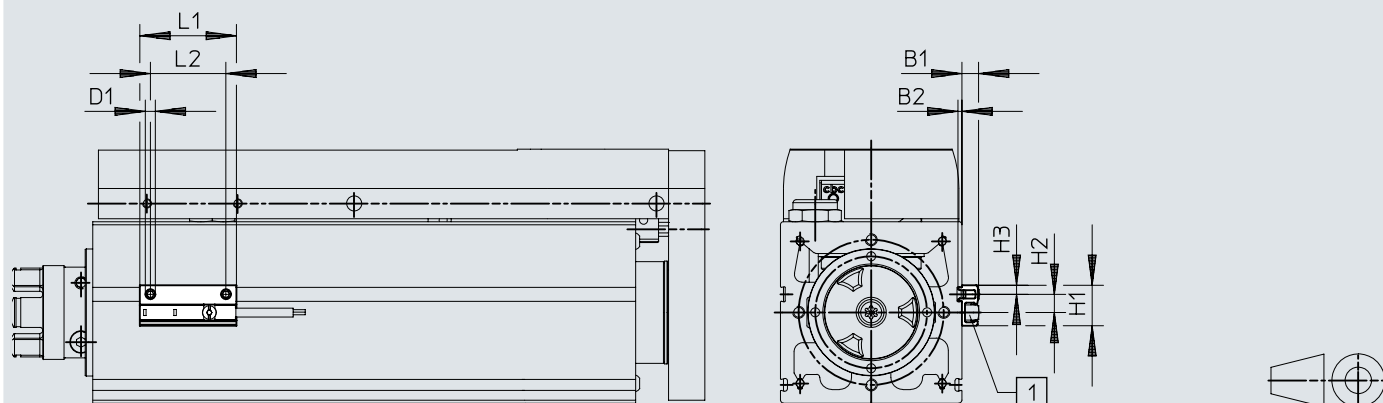

[1] Proximity switch

		B1	B2	D1	H1	H2	H3	L1	L2
EAPM-L2-SH	EGSS-BS-KF-32	5,5	1,3	M4	13,4	6	3	32	25
	EGSS-BS-KF-45								
	EGSS-BS-KF-60								

Ordering data

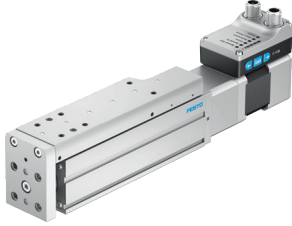
With recirculating ball bearing guide					
	Size	Spindle pitch	Working stroke	Part no.	Type
	32	8 mm/U	25 mm	8083801	EGSS-BS-KF-32-25-8P-ST-M-H1-PLK-AA
			50 mm	8083802	EGSS-BS-KF-32-50-8P-ST-M-H1-PLK-AA
			75 mm	8083803	EGSS-BS-KF-32-75-8P-ST-M-H1-PLK-AA
			100 mm	8083804	EGSS-BS-KF-32-100-8P-ST-M-H1-PLK-AA
	45	10 mm/U	25 mm	8083814	EGSS-BS-KF-45-25-10P-ST-M-H1-PLK-AA
			50 mm	8083815	EGSS-BS-KF-45-50-10P-ST-M-H1-PLK-AA
			75 mm	8083816	EGSS-BS-KF-45-75-10P-ST-M-H1-PLK-AA
			100 mm	8083817	EGSS-BS-KF-45-100-10P-ST-M-H1-PLK-AA
			125 mm	8083818	EGSS-BS-KF-45-125-10P-ST-M-H1-PLK-AA
	60	12 mm/U	150 mm	8083819	EGSS-BS-KF-45-150-10P-ST-M-H1-PLK-AA
			50 mm	8083716	EGSS-BS-KF-60-50-12P-ST-M-H1-PLK-AA
			75 mm	8083717	EGSS-BS-KF-60-75-12P-ST-M-H1-PLK-AA
			100 mm	8083718	EGSS-BS-KF-60-100-12P-ST-M-H1-PLK-AA
			125 mm	8083719	EGSS-BS-KF-60-125-12P-ST-M-H1-PLK-AA
			150 mm	8083720	EGSS-BS-KF-60-150-12P-ST-M-H1-PLK-AA
				200 mm	8083721

Ordering data – Modular product system				Further information → egss
	Size	Spindle pitch	Part no.	Type
	32	8 mm/U	8083800	EGSS-BS-KF-32-
	45	10 mm/U	8083813	EGSS-BS-KF-45-
	60	12 mm/U	8083713	EGSS-BS-KF-60-

Peripherals

Peripherals overview

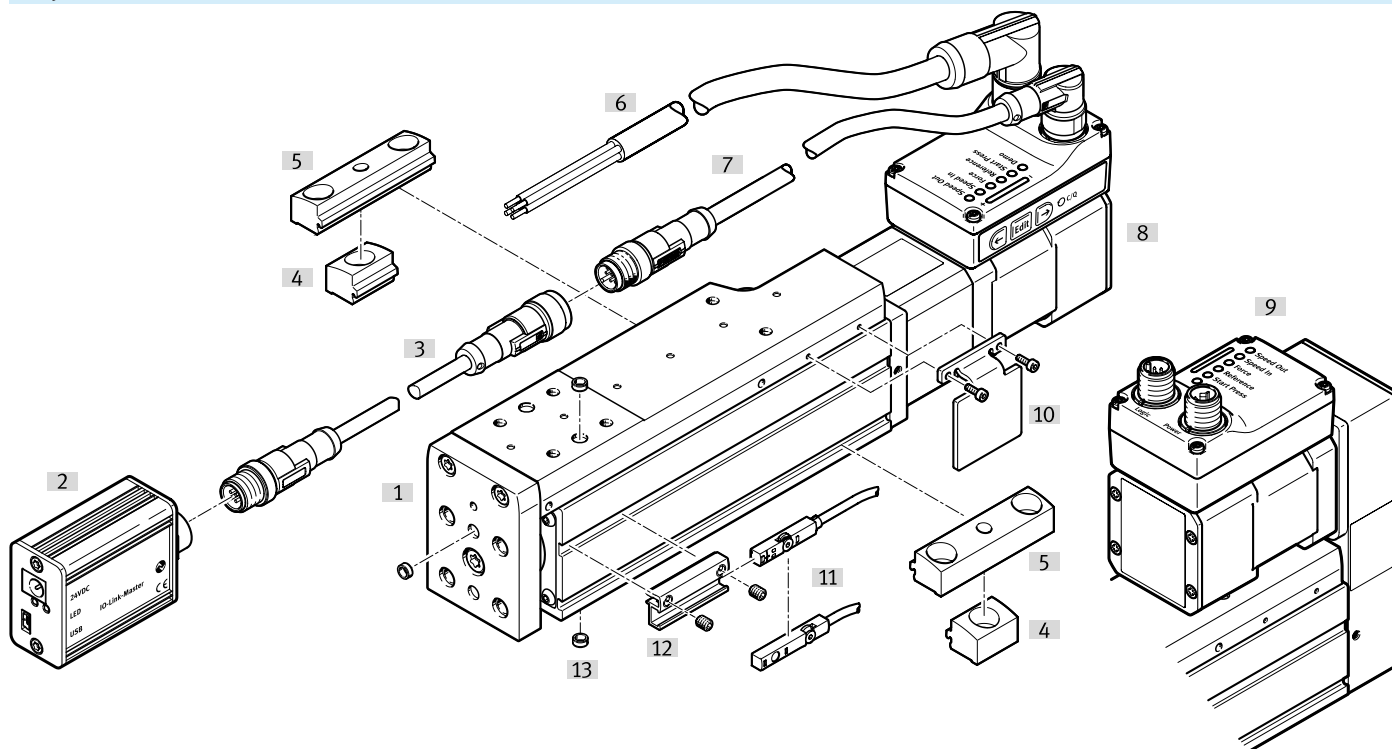

Accessories		→ Page/Internet
Type/order code	Description	
[1] Spindle axis ELGS-BS-KF	Electric drive	egss
[2] IO-Link® master USB CDSU-1	For easy use of the electric cylinder unit with IO-Link®	35
[3] Adapter NEFC-M12G8	<ul style="list-style-type: none"> • Connection between motor and IO-Link® master • Only recommended for use with IO-Link® Port class A master 	36
[4] Profile mounting EAHF-L2-...-P-S	For mounting the axis on the side of the profile	34
[5] Profile mounting EAHF-L2-...-P	For mounting the axis on the side of the profile. The profile mounting can be attached to the mounting surface using the drilled hole in the centre	34
[6] Supply cable NEBL-T12	For connecting the load and logic supply	36
[7] Connecting cable NEBC-M12	For connection to a controller	36
[8] Axial kit EAMM-A	For axial motor mounting (included in the scope of delivery)	-
[9] Parallel kit EAMM-U	For parallel motor mounting (included in the scope of delivery)	-
[10] Switch lug EAPM-L2-...-SLS	For sensing the slide position in conjunction with inductive proximity switches SIES-8M	34
[11] Proximity switch SIES-8M	<ul style="list-style-type: none"> • Inductive proximity sensors, for T-slot • Proximity switches are optional and are only required for sensing any intermediate positions 	35
[11] Proximity switch SMT-8M	<ul style="list-style-type: none"> • Magnetic proximity switches, for T-slot • Proximity switches are optional and are only required for sensing any intermediate positions 	35
[12] Sensor bracket EAPM-L2-SH	For mounting the proximity switches on the axis. The proximity switches can only be mounted using the sensor bracket	34
[13] Centring sleeve ZBS	For centring loads and attachments on the slide	34
[13] Centring pin ZBH	For centring loads and attachments on the slide	34

Accessories

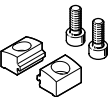
Profile mounting EAHF-L2-...-P-S						
	Description	Material plate	Note on materials	Product weight	Part no.	Type
	For size 32	Anodised wrought aluminium alloy	RoHS-compliant	4 g	5183153	EAHF-L2-25-P-S
	For size 45, 60			6 g	5184133	EAHF-L2-45-P-S

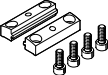
Profile mounting EAHF-L2-...-P						
	Description	Material plate	Note on materials	Product weight	Part no.	Type
	For size 32	Anodised wrought aluminium alloy	RoHS-compliant	19 g	4835684	EAHF-L2-25-P
	For size 45, 60			35 g	4835728	EAHF-L2-45-P

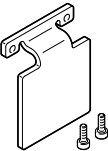
Switch lug EAPM-L2-SLS						
	Description	Material switch lug	Product weight	Note on materials	Part no.	Type
	For size 32		10 g	RoHS-compliant	8067259	EAPM-L2-32-SLS
	For size 45		18 g		8067260	EAPM-L2-45-SLS
	For size 60		27 g		8067261	EAPM-L2-60-SLS

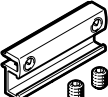
Sensor bracket EAPM-L2-SH						
	Description	Material sensor bracket	Note on materials	Product weight	Part no.	Type
	For sizes 32, 45, 60	Anodised wrought aluminium alloy	RoHS-compliant	4 g	★ 4759852	EAPM-L2-SH

Centring pin ZBS-4						
	Description	Material sleeve	Size of pack	Product weight	Part no.	Type
	For size 32	High-alloy stainless steel	10	0.5 g	562959	ZBS-4

Centring sleeve ZBH-5						
	Description	Material sleeve	Size of pack	Product weight	Part no.	Type
	For size 45	Steel	10	1 g	8146543	ZBH-5-B

Centring sleeve ZBH-7						
	Description	Material sleeve	Size of pack	Product weight	Part no.	Type
	For sizes 32, 45, 60	Steel	10	1 g	8146544	ZBH-7-B

Push-in fitting QSM-M5						
	Description	Material housing	Size of pack	Product weight	Part no.	Type
	For size 32, For sealing air connection	Brass, nickel-plated	10	3 g	133004	QSM-M5-4-I-R

Accessories

Push-in fitting QSM-M5						
	Description	Material housing	Size of pack	Product weight	Part no.	Type
	For size 32, For sealing air connection	Brass, nickel-plated	10	3.2 g	133003	QSM-M5-3-I-R

Push-in fitting QSM-G1/8						
	Description	Material housing	Size of pack	Product weight	Part no.	Type
	For size 45, 60, For sealing air connection	Brass, nickel-plated	10	8.9 g	★ 186266	QSM-G1/8-4-I
				9.5 g	★ 186267	QSM-G1/8-6-I

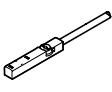
Proximity switch SIES for T-slot, inductive						Further information → sies-8m
	Switching output	Switching element function	Electrical connection 1, connector system	Cable length ¹⁾	Part no.	Type
	NPN	N/C contact	M8x1, A-coded, to EN 61076-2-104	0.3 m	551402	SIES-8M-NO-24V-K-0,3-M8D
			Open end	7.5 m	551401	SIES-8M-NO-24V-K-7,5-OE
		N/O contact	M8x1, A-coded, to EN 61076-2-104	0.3 m	551397	SIES-8M-NS-24V-K-0,3-M8D
			Open end	7.5 m	551396	SIES-8M-NS-24V-K-7,5-OE
	PNP	N/C contact	M8x1, A-coded, to EN 61076-2-104	0.3 m	551392	SIES-8M-PO-24V-K-0,3-M8D
			Open end	7.5 m	551391	SIES-8M-PO-24V-K-7,5-OE
		N/O contact	M8x1, A-coded, to EN 61076-2-104	0.3 m	551387	SIES-8M-PS-24V-K-0,3-M8D
			Open end	7.5 m	551386	SIES-8M-PS-24V-K-7,5-OE

1) For sizes 45 and 60, SIES-8M inductive proximity sensors must be used for strokes greater than 100 mm. Proximity switches are optional and are only required for sensing any intermediate positions.

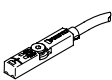
Proximity switch SMT for T-slot, magneto-resistive						Further information → smt-8m
	Type of mounting	Switching output	Electrical connection	Cable length ¹⁾	Part no.	Type
	Screw-clamped, Insertable in the slot from above	3-wire PNP N/C contact	Open end	7.5 m	★ 574340	SMT-8M-A-PO-24V-E-7,5-OE
				2.5 m	★ 574335	SMT-8M-A-PS-24V-E-2,5-OE
		3-wire PNP N/O contact	Plug M8, A-coded	0.3 m	★ 574334	SMT-8M-A-PS-24V-E-0,3-M8D

1) Proximity switches are optional and are only required for sensing any intermediate positions.

IO-Link® master USB				Further information → cdsu
	Description	Part no.	Type	
	For using the unit with IO-Link®, an external power supply plug is also required (not included in the scope of delivery)	8091509	CDSU-1	

Accessories

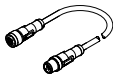
Adapter NEFC						
	Electrical connection 1, connector system	Electrical connection 2, connector system ¹⁾	Electrical connection 2, number of connections/cores	Cable length	Part no.	Type
	M12x1, A-coded to EN 61076-2-101	M12x1, A-coded to EN 61076-2-101	5	0.3 m	8080777	NEFC-M12G8-0.3-M12G5-LK

1) Only recommended for use with IO-Link® Port class A master

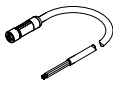
Supply cables NEBL, straight						
	Electrical connection 1, connector system	Electrical connection 2, connector system	Electrical connection 2, number of connections/cores	Cable length	Part no.	Type
	M12x1, T-coded according to EN 61076-2-111	Open end	4	2 m	8080790	NEBL-T12G4-E-2-N-LE4
				5 m	8080791	NEBL-T12G4-E-5-N-LE4
				10 m	8080792	NEBL-T12G4-E-10-N-LE4
				15 m	8080793	NEBL-T12G4-E-15-N-LE4

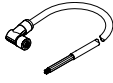
Supply cables NEBL, angled						
	Electrical connection 1, connector system	Electrical connection 2, connector system	Electrical connection 2, number of connections/cores	Cable length	Part no.	Type
	M12x1, T-coded according to EN 61076-2-111	Open end	4	2 m	8080778	NEBL-T12W4-E-2-N-LE4
				5 m	8080779	NEBL-T12W4-E-5-N-LE4
				10 m	8080780	NEBL-T12W4-E-10-N-LE4
				15 m	8080781	NEBL-T12W4-E-15-N-LE4

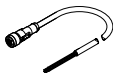
Connecting cables NEBC, straight						
	Electrical connection 1, connector system	Electrical connection 2, connector system	Electrical connection 2, number of connections/cores	Cable length	Part no.	Type
	M12x1, A-coded to EN 61076-2-101	M12x1, A-coded to EN 61076-2-101	8	2 m	8080782	NEBC-M12G8-E-2-N-M12G8
				5 m	8080783	NEBC-M12G8-E-5-N-M12G8
				10 m	8080784	NEBC-M12G8-E-10-N-M12G8
				15 m	8080785	NEBC-M12G8-E-15-N-M12G8
		Open end	2 m	8094480	NEBC-M12G8-E-2-N-B-LE8	
			5 m	8094477	NEBC-M12G8-E-5-N-B-LE8	
			10 m	8094482	NEBC-M12G8-E-10-N-B-LE8	
			15 m	8094475	NEBC-M12G8-E-15-N-B-LE8	

Connecting cables NEBC, angled						
	Electrical connection 1, connector system	Electrical connection 2, connector system	Electrical connection 2, number of connections/cores	Cable length	Part no.	Type
	M12x1, A-coded to EN 61076-2-101	M12x1, A-coded to EN 61076-2-101	8	2 m	8080786	NEBC-M12W8-E-2-N-M12G8
				5 m	8080787	NEBC-M12W8-E-5-N-M12G8
				10 m	8080788	NEBC-M12W8-E-10-N-M12G8
				15 m	8080789	NEBC-M12W8-E-15-N-M12G8
		Open end	2 m	8094476	NEBC-M12W8-E-2-N-B-LE8	
			5 m	8094478	NEBC-M12W8-E-5-N-B-LE8	
			10 m	8094481	NEBC-M12W8-E-10-N-B-LE8	
			15 m	8094479	NEBC-M12W8-E-15-N-B-LE8	