

## Planar surface gantries

**FESTO**

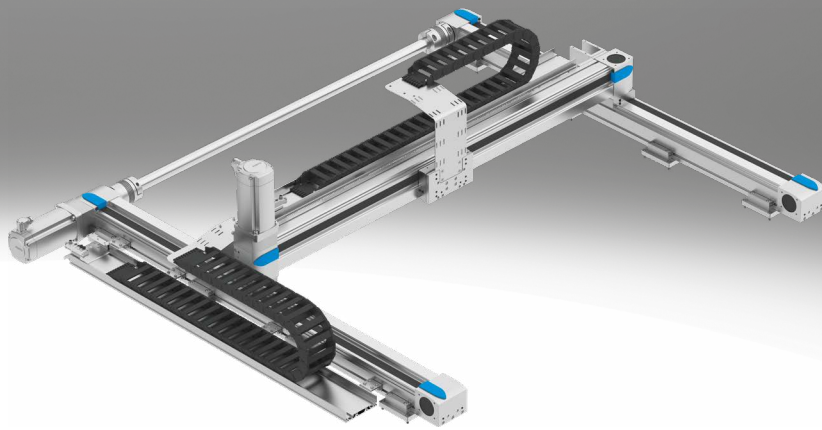

## Key features

### At a glance

The planar surface gantry facilitates movement in 2D space. Depending on the requirements, the gantry is either composed of several axis modules (YXCF) or using the planar surface gantries EXCM or EXCH (YXMF). These are all tried-and-tested components from Festo.

- Can be used generally for light to very heavy workpieces or high payloads
- Especially suitable for very long strokes
- High mechanical rigidity and sturdy design
- Freely positionable/any intermediate positions

Range of applications:

- For any movements in 2D space
- Very demanding requirements for precision and/or very heavy workpieces combined with long strokes (YXCR)
- Cost-effective handling unit in a compact format for small parts handling and simple tasks (YXCR-B)

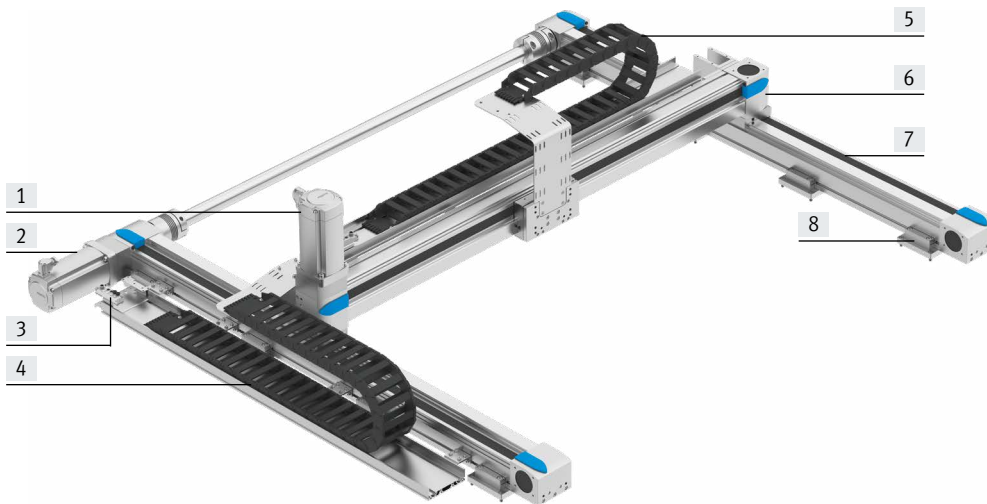

- [1] Servo motor for the Y-module
- [2] Servo motor of the X-module
- [3] Multi-pin plug distributor which transfers all the electrical signals such as for end-position sensing
- [4] Energy chain for the X-module
- [5] Energy chain for the Y-module
- [6] Y-axis
- [7] X-axis
- [8] Profile mounting/adjusting kit

### Description of the modules

#### X-module

Design:

Depending on the configuration, the X-module comprises either two drive axes joined together by a connecting shaft (YXCF) or one drive axis + separate guide axis (YXCF-B).

They are powered by a servo or stepper motor.

Adapters are mounted on the slides of the X-axes to connect the Y-module.

The position of the motor and energy chain can be selected using the configurator.

The following components are located on the motor side:

- Energy chain (optional)
- Multi-pin plug distributor for proximity switch (if a sensor package has been selected)

Sample image:

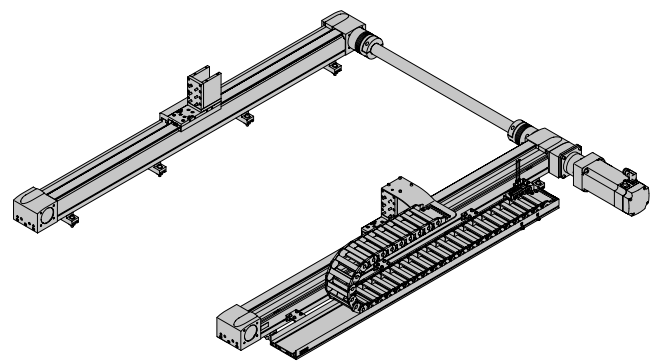

## Key features

### Description of the modules

#### Y-module

##### Design:

The Y-module EHYM comprises a linear axis which is powered by a servo or stepper motor.

The position of the motor and energy chain is dependent on the position of the motor on the X-module.

The following components are located on the motor side:

- Energy chain (optional)
- Multi-pin plug distributor for proximity switch (if a sensor package has been selected)

##### Sample image:

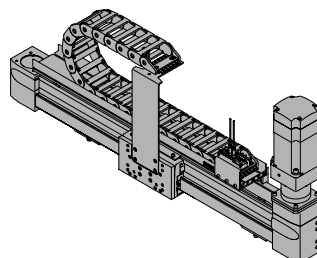

#### XY-module (EXCM, EXCH)

##### Design:

A slide is moved in a two-dimensional space (X-axis/Y-axis) via a toothed belt.

The system is powered by two fixed motors. The motors are coupled to the toothed belt. The belt is guided via guide pulleys so that the slide can move to any position in a working space when the motors are actuated accordingly.

When using attachment components, additional processes can be carried out by independent Z-axes.

##### Sample image:

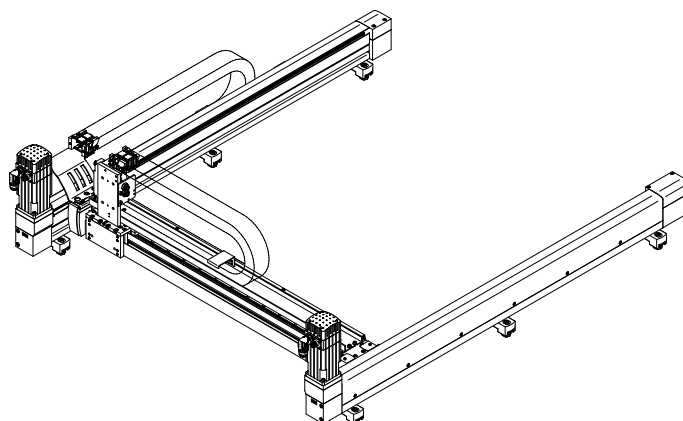

#### Dispatch options

##### Fully assembled:

The 2D planar surface gantry is fully assembled. All cables are installed and connected. The system is already set up on delivery, but must be adapted to the particular mounting surface during installation.

Note flatness → table below.

##### Partially assembled:

The 2D planar surface gantry is delivered partially assembled. This means that both axis modules (X-/Y-axis) are assembled, each with optional motors. The partially assembled system must be completed by the customer. Help can be found in the assembly instructions provided.

Optional accessories (→ page 10) are enclosed.

Note flatness → table below.

System overview <sup>1)</sup>							
Size	YXCF-1	YXCF-2	YXCF-3	YXCF-4	YXMF-1	YXMF-2	YXMF-3
Max. working stroke	X: 1900 mm Y: 1800 mm	X: 3000 mm Y: 1820 mm	X: 3000 mm Y: 1755 mm	X: 3000 mm Y: 1640 mm	X: 700 mm Y: 510 mm	X: 2000 mm Y: 1000 mm	X: 2500 mm Y: 1500 mm
Max. payload	Dependent on the selected dynamic response						
Required flatness of the mounting surface	≤ 0.1 mm/m						
Mounting position	Horizontal						

Size	YXCF-1-B	YXCF-2-B
Max. working stroke	X: 800 mm Y: 600 mm	X: 1000 mm Y: 800 mm
Max. payload	Dependent on the selected dynamic response	
Required flatness of the mounting surface	≤ 0.1 mm/m	
Mounting position	Horizontal	

1) Drive package depends on the configuration selected.

## Key features

### Configurator: Handling Guide Online (HGO)

#### Selecting a handling system

Planning complex handling systems takes a lot of time. You can use the configurator "Handling Guide Online" (HGO) to design a customised handling system for your application in just a few steps.

You can choose from the following systems:





- Single-axis system
- 2D linear gantry
- 2D planar surface gantry
- Three-dimensional gantry
- 3D cantilever system

#### Advantages:

- Automatic selection of all relevant components
- Automatic design and calculation of the workload
- Quote created automatically
- CAD model available immediately
- Configuration-specific parameters for servo drives available immediately
- Complete Eplan project can be ordered according to the individual configuration
- Fully automated processing
- You can order fully or partially assembled systems through the Online Shop
- Lots of possible options

### Selecting the handling solution

Select your handling system

<input type="radio"/> Single-axis system		<p>Single-axis movement: Single-axis module as a complete system. Easy to connect to your own front unit.</p> <p><input type="checkbox"/> Animation</p>
<input type="radio"/> 2D linear gantry		<p>Movements in 2D in the vertical working space: Linear gantries as complete systems. Electric and pneumatic axes can be combined</p> <p><input type="checkbox"/> Animation</p>
<input type="radio"/> 2D gantry		<p>Movements in 2D in the horizontal working space: Planar surface gantries as complete systems. Combining electric axes. Easy to connect to your own Z unit.</p> <p><input type="checkbox"/> Animation</p>
<input type="radio"/> 3D gantry		<p>Movements in 3D: Three-dimensional gantries as complete systems. Electric and pneumatic axes can be combined</p> <p><input type="checkbox"/> Animation</p>
<input type="radio"/> 3D cantilever system		<p>Movements in 3D: Cantilever system as complete system. Electric and pneumatic axes can be combined</p>

### Entering the application data

- Payload
- Drive system of the axis
- Distance from the centre of the load
- Working stroke
- Reference cycle

### Axis definition and payload

Axis definition

Drive system of the axis	X Electric: several positions
	Y Electric: several positions
Required working stroke	i X <input type="text" value="200"/> mm
	i Y <input type="text" value="200"/> mm

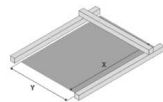

Sum of the weight of the front unit and the workpiece	<input type="text" value="1"/> kg
Distance from the centre of the load	i X <input type="text"/> mm
	i Y <input type="text"/> mm
	i Z <input type="text"/> mm

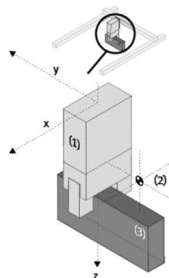

Data protection

[Back](#) [Continue](#)

## Key features

### Configurator: Handling Guide Online (HGO)

Result of the calculation

You will be offered a selection of systems that have been calculated based on the application data you entered.

The following are available immediately:

- CAD model
- Datasheet of the selected system
- Price information

### Result of calculation

Select the appropriate system and continue with the configuration:

Selection Filter

No.	System series	System workload i	Repetition accuracy (+/-)	Your price
<input checked="" type="checkbox"/>	1 YXMF-1	75 %	0.05 mm	
<input type="checkbox"/>	3 YXCF-1	22 %	0.11 mm	
<input type="checkbox"/>	5 YXCF-2	72 %	0.11 mm	
<input type="checkbox"/>	7 YXCF-2	75 %	0.11 mm	
<input type="checkbox"/>	9 YXCF-2	9 %	0.11 mm	

2D gantry YXMF-1: #1

Drive module	XY module: Planar surface gantry EXCM-30
Kinematics type	Parallel kinematics
Stroke	100 mm/120 mm
Repetition accuracy (+/-)	-
Gear unit	Without
Type of motor	Stepper motor EMMS-ST
Motor position	Underneath
Motor controller	CMXH-ST2

Data protection

Back Continue

### System overview

You will be given an overview of the complete system.

- Show price
- Send request
- Add to basket

You will also have the following options:

### Your handling solution

Your selected system overview:

Exemplary representation



Update CAD Preview

Your system ID:  
**C1374165**

Your next step:

[Show price](#)

[Send request](#)

[Add to basket](#)

Feature	Value
Handling type	2D gantry
Payload	2 kg
Drive system of the X-axis	Electric: several positions
Drive system of the Y-axis	Electric: several positions

Data protection Back

## Key features

### Standard components within the handling system

The handling system comprises a number of tried-and-tested standard components from Festo. Different components are used depending on the configuration. The single axes installed will be displayed in the configurator HGO on the "Result of the calculation" page.

### Drives/axes

#### X-axis

##### Toothed belt axis EGC-TB-KF



- Electrical
- Rigid, closed profile
- Recirculating ball bearing guide for high loads and torques
- High dynamic response and minimum vibration

##### Ball screw axis ELGC-BS



- Electrical
- Optimal installation space to working space ratio
- Protected against external influences by internal guide
- Various spindle pitches

##### Guide axis ELFC



- Driveless linear guide unit with guide and freely movable slide unit
- The guide axis is designed to support forces and torques in multi-axis applications

#### Y-axis

##### Toothed belt axis EGC-TB-KF



- Electrical
- Rigid, closed profile
- Recirculating ball bearing guide for high loads and torques
- High dynamic response and minimum vibration

##### Ball screw axis ELGC-BS



- Electrical
- Optimal installation space to working space ratio
- Protected against external influences by internal guide
- Various spindle pitches

##### Toothed belt axis EGC-HD-TB

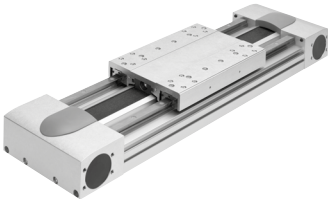

- Electrical
- Flat drive unit with rigid, closed profile
- Duo guide rail
- For maximum loads and torques, high feed forces and speeds and long service life

## Key features

Possible axis combinations <sup>1)</sup>		
Size	X-module	Y-module
YXCF-1	<ul style="list-style-type: none"> <li>Toothed belt axis EGC-50-TB-KF</li> </ul>	<ul style="list-style-type: none"> <li>Toothed belt axis EGC-50-TB-KF</li> </ul>
YXCF-1-B	<ul style="list-style-type: none"> <li>Ball screw axis ELGC-60-BS</li> </ul>	<ul style="list-style-type: none"> <li>Ball screw axis ELGC-45-BS</li> <li>Ball screw axis ELGC-60-BS</li> </ul>
YXCF-2	<ul style="list-style-type: none"> <li>Toothed belt axis EGC-80-TB-KF</li> </ul>	<ul style="list-style-type: none"> <li>Toothed belt axis EGC-80-TB-KF</li> <li>Toothed belt axis with heavy-duty guide EGC-HD-125-TB</li> </ul>
YXCF-2-B	<ul style="list-style-type: none"> <li>Ball screw axis ELGC-80-BS</li> </ul>	<ul style="list-style-type: none"> <li>Ball screw axis ELGC-60-BS</li> <li>Ball screw axis ELGC-80-BS</li> </ul>
YXCF-3	<ul style="list-style-type: none"> <li>Toothed belt axis EGC-120-TB-KF</li> </ul>	<ul style="list-style-type: none"> <li>Toothed belt axis EGC-120-TB-KF</li> <li>Toothed belt axis with heavy-duty guide EGC-HD-160-TB</li> </ul>
YXCF-4	<ul style="list-style-type: none"> <li>Toothed belt axis EGC-185-TB-KF</li> </ul>	<ul style="list-style-type: none"> <li>Toothed belt axis EGC-185-TB-KF</li> <li>Toothed belt axis with heavy-duty guide EGC-HD-220-TB</li> </ul>
YXMF-1	<ul style="list-style-type: none"> <li>Planar surface gantry EXCM-30</li> </ul>	<ul style="list-style-type: none"> <li>Planar surface gantry EXCM-30</li> </ul>
YXMF-2	<ul style="list-style-type: none"> <li>Planar surface gantry EXCM-40, EXCH-40</li> </ul>	<ul style="list-style-type: none"> <li>Planar surface gantry EXCM-40, EXCH-40</li> </ul>
YXMF-3	<ul style="list-style-type: none"> <li>Planar surface gantry EXCH-60</li> </ul>	<ul style="list-style-type: none"> <li>Planar surface gantry EXCH-60</li> </ul>

1) Drive package depends on the configuration selected.

## Key features

### Standard components within the handling system

The handling system comprises a number of tried-and-tested standard components from Festo. Different components are used depending on the configuration. You can alter the scope and design of the drive package in the configurator HGO on the "System configuration" page.

### Motors and controllers

#### Servo motors EMMT-AS



- Dynamic, brushless, permanently excited servo motor
- Digital absolute displacement encoder in single-turn or multi-turn version
- Simple connection technology (OCP: one cable plug) – hybrid cable: motor cable and connecting cable for supply and encoder in one
- Plug can be rotated 310°
- With optional brake

#### Servo motors EMMB-AS



- Dynamic, brushless, permanently excited servo motor
- Digital absolute displacement encoder in single-turn or multi-turn version
- Optimised connection technology
- With optional brake

#### Stepper motors EMMT-ST

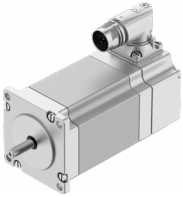

- Two-phase hybrid technology
- Digital absolute displacement encoder in single-turn or multi-turn version
- Simple connection technology (OCP: one cable plug) – hybrid cable: motor cable and connecting cable for supply and encoder in one
- Plug can be rotated 310°
- With optional brake

#### Stepper motors EMMB-ST

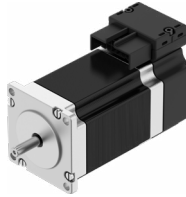

- Two-phase hybrid technology
- Digital absolute displacement encoder in single-turn or multi-turn version
- Simple connection technology (OCP: one cable plug) – hybrid cable: motor cable and connecting cable for supply and encoder in one
- Can be positioned to the front or the rear
- With optional brake

#### Gear unit EMGA



- Low-backlash planetary gear
- Gear ratio  
i = 3 and 5
- Life-time lubrication



## Key features

### Standard components within the handling system

The handling system comprises a number of tried-and-tested standard components from Festo. Different components are used depending on the configuration. You can alter the scope and design of the drive package in the configurator HGO on the "System configuration" page.

#### Servo drive CMMT-AS, for servo motor



- Universal servo drive
- For synchronous servo motors
- Integrated EMC filters
- Integrated brake chopper
- Integrated braking resistor
- Position controller
- Speed controller
- Force controller
- Range of control functions

#### Options:

- Safety function: safe torque off (STO)/category 4, Performance Level e
- Safe stop 1 (SS1)
- Safe brake control (SBC) up to SIL3/category 3, Performance Level e

- Bus protocols
  - EtherCAT®
  - PROFINET RT/IRT
  - EtherNet/IP
  - Modbus TCP

#### Servo drive CMMT-ST, for stepper motor



- Servo drive for operating stepper motors and brushless direct current motors
- Options for point-to-point and interpolating motion and for precise positioning
- Primary voltage from 24 ... 48 V DC
- Position controller
- Speed controller
- Force controller
- Range of control functions

#### Options:

- Safety function: safe torque off (STO)/category 3, Performance Level e
- Safe stop 1 time controlled (SS1-t)

- Bus protocols
  - EtherCAT®
  - PROFINET RT/IRT
  - EtherNet/IP
  - Modbus TCP

## Ordering data – Accessories

## Module/motor combinations

We recommend that the 2D planar surface gantry is operated with the proposed motors from Festo. These precisely match the mechanical system. When using third-party motors, it is essential that the technical limits are observed.

Module	Motor		Stepper motor	
	Servo motor			
<b>X-module</b>				
EHM-EGC-50-TB-KF	–	–	EMMT-ST-42-L-...	EMMB-ST-42-L-...
EHMX-EGC-80-TB-KF	EMMT-AS-60-L-LS-...	–	EMMT-ST-57-L-...	EMMB-ST-57-L-...
	EMMT-AS-100-M-HS-...	–		
EHMX-EGC-120-TB-KF	EMMT-AS-80-L-LS-...	–	–	–
	EMMT-AS-80-L-HS-...	–		
EHMX-EGC-185-TB-KF	EMMT-AS-100-L-HS-...	–	–	–
	EMMT-AS-100-H-HS-...	–	–	–
	EMMT-AS-150-M-HS-R2...	–	–	–
EHM-ELGC-60-BS	–	EMMB-AS-80-07	EMMT-ST-57-L-...	EMMB-ST-57-L-...
EHM-ELGC-80-BS	–	EMMB-AS-80-07	EMMT-ST-87-M-...	EMMB-ST-87-M-...
<b>Y-module</b>				
EHY-...-EGC-50-TB-KF	–	–	EMMT-ST-57-L-...	EMMT-ST-57-L-...
EHY-...-EGC-80-TB-KF	EMMT-AS-60-S-LS-...	–	EMMT-ST-57-M-...	EMMT-ST-57-M-...
EHY-...-EGC-120-TB-KF	EMMT-AS-80-L-LS-...	–	–	–
	EMMT-AS-80-L-HS-...	–		
EHY-...-EGC-125-TB-HD	EMMT-AS-60-L-LS-...	–	EMMT-ST-57-M-...	EMMT-ST-57-M-...
EHY-...-EGC-160-TB-HD	EMMT-AS-80-M-LS-...	–	–	–
	EMMT-AS-80-L-HS-...	–		
EHY-...-EGC-185-TB-KF	EMMT-AS-100-L-HS-...	–	–	–
EHY-...-EGC-220-TB-HD	EMMT-AS-100-L-HS-...	–	–	–
	EMMT-AS-100-H-HS-...	–	–	–
EHY-RP-ELGC-45-BS	–	EMMB-AS-40-01	EMMT-ST-42-L-...	EMMB-ST-42-L-...
EHY-RP-ELGC-60-BS	–	EMMB-AS-60-04	EMMT-ST-57-L-...	EMMB-ST-57-L-...
EHY-RP-ELGC-80-BS	–	EMMB-AS-60-04	EMMT-ST-87-M-...	EMMB-ST-87-M-...
<b>XY-module (EXCM, EXCH)</b>				
EXCM-30	–	–	EMMT-ST-42-L-...	EMMB-ST-42-L-...
EXCM-40	–	–	EMMT-ST-87-S-...	EMMB-ST-87-S-...
EXCH-40	EMMT-AS-80-M-LS-...	–	–	–
	EMMT-AS-80-L-HS-...	–	–	–
EXCH-60	EMMT-AS-100-M-HS-...	–	–	–
	EMMT-AS-150-M-HV-R3...	–	–	–

## Ordering data – Accessories

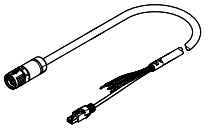
Ordering data	Description	Cable length [m]	Part no.	Type
<b>For servo motor EMMT-AS</b>				
<b>Motor cable</b>				
	• For EMMT-AS-60/80-...-R2... with CMMT-AS	2.5	5251374	NEBM-M23G15-EH-2.5-Q7N-R3LEG14
		5	5251375	NEBM-M23G15-EH-5-Q7N-R3LEG14
		7.5	5251376	NEBM-M23G15-EH-7.5-Q7N-R3LEG14
		10	5251377	NEBM-M23G15-EH-10-Q7N-R3LEG14
		15	5251378	NEBM-M23G15-EH-15-Q7N-R3LEG14
		20	5251379	NEBM-M23G15-EH-20-Q7N-R3LEG14
	• For EMMT-AS-100-...-R2... with CMMT-AS • For EMMT-AS-150-...-R2... with CMMT-AS	2.5	5251381	NEBM-M23G15-EH-2.5-Q9N-R3LEG14
		5	5251382	NEBM-M23G15-EH-5-Q9N-R3LEG14
		7.5	5251383	NEBM-M23G15-EH-7.5-Q9N-R3LEG14
		10	5251384	NEBM-M23G15-EH-10-Q9N-R3LEG14
		15	5251385	NEBM-M23G15-EH-15-Q9N-R3LEG14
		20	5251386	NEBM-M23G15-EH-20-Q9N-R3LEG14
	• For EMMT-AS-150-...-R3... with CMMT-AS	2.5	5251395	NEBM-M40G15-EH-2.5-Q11N-R3LEG14
		5	5251396	NEBM-M40G15-EH-5-Q11N-R3LEG14
		7.5	5251397	NEBM-M40G15-EH-7.5-Q11N-R3LEG14
10		5251398	NEBM-M40G15-EH-10-Q11N-R3LEG14	
15		5251399	NEBM-M40G15-EH-15-Q11N-R3LEG14	
20		5251400	NEBM-M40G15-EH-20-Q11N-R3LEG14	

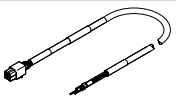
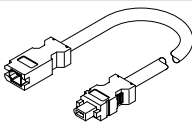
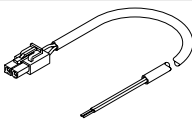
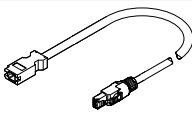
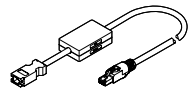
Ordering data	Description	Cable length [m]	Part no.	Type
<b>For servo motor EMMB-AS</b>				
<b>Motor cable</b>				
	• For EMMB-AS-40/60/80 with CMMT-AS	2.5	5219197	NEBM-H6G4-E-2.5-Q13N-LE4
		5	5219198	NEBM-H6G4-E-5-Q13N-LE4
		7.5	5219199	NEBM-H6G4-E-7.5-Q13N-LE4
		10	5219200	NEBM-H6G4-E-10-Q13N-LE4
		15	8097203	NEBM-H6G4-E-15-Q13N-LE4
<b>Encoder cable</b>				
	• For EMMB-AS-40/60/80 with CMMT-AS	2.5	5219213	NEBM-REG6-E-2.5-Q14N-REG6
		5	5219214	NEBM-REG6-E-5-Q14N-REG6
		7.5	5219215	NEBM-REG6-E-7.5-Q14N-REG6
		10	5219216	NEBM-REG6-E-10-Q14N-REG6
		15	8097200	NEBM-REG6-E-15-Q14N-REG6
<b>Connecting cable for brake</b>				
	• For EMMB-AS-40/60/80 with CMMT-AS	2.5	5219205	NEBM-H7G2-E-2.5-Q14N-LE2
		5	5219206	NEBM-H7G2-E-5-Q14N-LE2
		7.5	5219207	NEBM-H7G2-E-7.5-Q14N-LE2
		10	5219208	NEBM-H7G2-E-10-Q14N-LE2
		15	8097206	NEBM-H7G2-E-15-Q14N-LE2
<b>Adapter for encoder cable (absolutely essential)</b>				
	• For EMMB-AS-40/60/80 with CMMT-AS	<b>For single-turn version with CMMT-AS</b>		
		0.5	8097197	NEFM-REG6-K-0.5-R3G8
	• For EMMB-AS-40/60/80 with CMMT-AS <sup>1)</sup>	<b>For multi-turn version with CMMT-AS<sup>1)</sup></b>		
		0.5	8097195	NEFM-REG6-K-0.5-B-R3G8
		0.5	8097196	NEFM-REG6-K-0.5-B-REG6

1) The required battery is not included in the scope of delivery

## Ordering data – Accessories

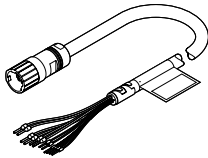
Designation	Description	Cable length [m]	Part no.	Type
<b>For stepper motor EMMT-ST</b>				
<b>Motor cable</b>				
	• For EMMT-ST-42-... with CMMT-ST	2.5	8181670	NEBM-M17G12-EH-2.5-Q6N-LE12
		5	8181668	NEBM-M17G12-EH-5-Q6N-LE12
		7	8190096	NEBM-M17G12-EH-7.5-Q6N-LE12
		10	8195457	NEBM-M17G12-EH-10-Q6N-LE12
		15	8214679	NEBM-M17G12-EH-15-Q7N-LE12
	• For EMMT-ST-57-... with CMMT-ST	2.5	8181670	NEBM-M17G12-EH-2.5-Q6N-LE12
		5	8181668	NEBM-M17G12-EH-5-Q6N-LE12
		7	8195460	NEBM-M17G12-EH-7.5-Q7N-LE12
		10	8195461	NEBM-M17G12-EH-10-Q7N-LE12
		15	8214683	NEBM-M17G12-EH-15-Q9N-LE12
	• For EMMT-ST-87-... with CMMT-ST	2.5	8195458	NEBM-M17G12-EH-2.5-Q7N-LE12
		5	8195459	NEBM-M17G12-EH-5-Q7N-LE12
		7	8214681	NEBM-M17G12-EH-7.5-Q9N-LE12
		10	8214682	NEBM-M17G12-EH-10-Q9N-LE12
		15	8214683	NEBM-M17G12-EH-15-Q9N-LE12

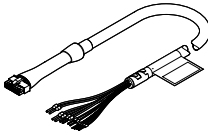
Designation	Description	Cable length [m]	Part no.	Type
<b>For stepper motor EMMB-ST</b>				
<b>Motor cable</b>				
	• For EMMB-ST-42-... with CMMT-ST	2.5	8181675	NEBM-L5G14-EH-2.5-Q6N-LE12
		5	8181664	NEBM-L5G14-EH-5-Q6N-LE12
		7	8181676	NEBM-L5G14-EH-7.5-Q6N-LE12
		10	8181672	NEBM-L5G14-EH-10-Q6N-LE12
		15	8214680	NEBM-L5G14-EH-15-Q6N-LE12
	• For EMMB-ST-57-... with CMMT-ST	2.5	8181677	NEBM-L10G14-EH-2.5-Q6N-LE12
		5	8181667	NEBM-L10G14-EH-5-Q6N-LE12
		7	8181674	NEBM-L10G14-EH-7.5-Q7N-LE12
		10	8181673	NEBM-L10G14-EH-10-Q7N-LE12
		15	8214689	NEBM-L10G14-EH-15-Q9N-LE12
	• For EMMB-ST-87-... with CMMT-ST	2.5	8181666	NEBM-L10G14-EH-2.5-Q7N-LE12
		5	8181671	NEBM-L10G14-EH-5-Q7N-LE12
		7	8214687	NEBM-L10G14-EH-7.5-Q9N-LE12
		10	8214688	NEBM-L10G14-EH-10-Q9N-LE12
		15	8214689	NEBM-L10G14-EH-15-Q9N-LE12

### Possible cable and tube lengths



- Cables and tubing are selected so that the length specified when ordering will be the minimum connection length from the energy chain output.
- Cables and tubing are only available in fixed lengths as stated in the table below. This can mean that the cable plugs of the different cables do not end at the same point.

Length	1 m	2 m	5 m	7 m	10 m
Motor cable	–	■	■	■	■
Encoder cable	–	■	■	■	■
Multi-pin plug connecting cable	–	■	■	■	■
Tubing (for DHMZ only)	■	■	■	–	–

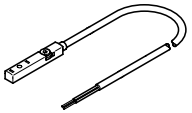

## Ordering data – Accessories

## Standard components within the handling system

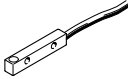
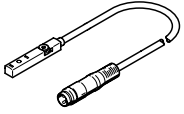

The handling system comprises a number of tried-and-tested standard components from Festo. Different components are used depending on the configuration. You can alter the scope and design of the accessories in the configurator HGO on the "System configuration" page.

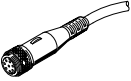
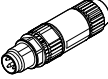
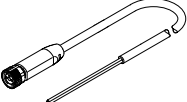
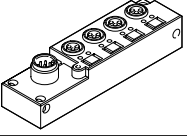
Designation	Description	Cable length [m]	Part no.	Type	
<b>Proximity switch (inductive) for sensing the position of the slide on the X-/Y-/Z-axis</b>					
	<b>Cable with open end</b>				
	<ul style="list-style-type: none"> <li>For toothed belt axis EGC-TB, EGC-HD-TB</li> <li>For ball screw axis EGC-BS</li> <li>For ball screw axis ELGC-BS</li> <li>For DC voltage</li> </ul> Included if the "Festo sensor package" is selected: <ul style="list-style-type: none"> <li>For EGC, ELGC: 2 pieces</li> </ul>	PNP, N/C contact	7.5	551391	SIES-8M-PO-24V-K-7.5-OE
		PNP, N/O contact	7.5	551386	SIES-8M-PS-24V-K-7.5-OE
		NPN, N/C contact	7.5	551401	SIES-8M-NO-24V-K-7.5-OE
		NPN, N/O contact	7.5	551396	SIES-8M-NS-24V-K-7.5-OE
<b>Proximity switches for sensing the position of the slide on the X-axis</b>					
	<ul style="list-style-type: none"> <li>For EXCM-40, EXCH-40, EXCH-60</li> </ul> PNP, N/O contact	–	150491	SIES-V3B-PS-S-L	
	<ul style="list-style-type: none"> <li>For EXCM-40, EXCH-40, EXCH-60</li> </ul> PNP, N/C contact	–	174552	SIES-Q8B-PO-K-L	
<b>Proximity switch (inductive) for sensing the position of the slide on the Y-axis</b>					
	<b>Cable with plug</b>				
	<ul style="list-style-type: none"> <li>For EXCM-40, EXCH-40, EXCH-60</li> <li>For DC voltage</li> </ul> Included if the "Festo sensor package" is selected: <ul style="list-style-type: none"> <li>1 piece</li> </ul>	PNP, N/C contact	0.3	551392	SIES-8M-PO-24V-K-0.3-M8D
		PNP, N/O contact	0.3	551387	SIES-8M-PS-24V-K-0.3-M8D

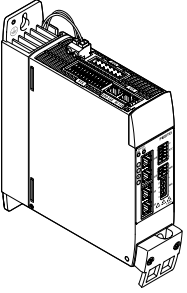
## Ordering data – Accessories

Designation	Description	Cable length [m]	Part no.	Type
<b>Plug socket with cable</b>				
	• Connection between multi-pin plug distributor NEDU and control cabinet	5	525618	SIM-M12-8GD-5-PU
		10	570008	SIM-M12-8GD-10-PU
<b>Plug</b>				
	• For connection to the multi-pin plug distributor NEDU / distributor NEDY	–	562024	NECU-S-M8G3-HX
<b>Connecting cable</b>				
	• Connection between distributor NEDY and control cabinet	2.5	8078227	NEBA-M8G4-U-2.5-N-LE4
		5	8078228	NEBA-M8G4-U-5-N-LE4
		7.5	8215486	NEBA-M8G4-U-7.5-N-LE4
		10	8078229	NEBA-M8G4-U-10-N-LE4
		15	8215487	NEBA-M8G4-U-15-N-LE4
<b>Multi-pin plug distributor</b>				
	• With the help of the multi-pin plug distributor, all electrical signals such as for end-position sensing can be transferred Options: – 4 individual connections – 6 individual connections	–	574586	NEDU-L4R1-M8G3L-M12G8
			574587	NEDU-L6R1-M8G3L-M12G8
	• With the help of the distributor, all electrical signals such as for end-position sensing can be transferred – 2 individual connections	–	8005312	NEDY-L2R1-V1-M8G3-N-M8G4
<b>Motor controller/servo drive</b>				
	The accessories for the relevant motor controllers/servo drives can be found at: • <a href="http://www.festo.com/catalogue/cmmt">www.festo.com/catalogue/cmmt</a>			

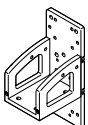
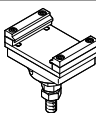
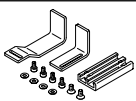
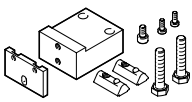
## Ordering data – Accessories

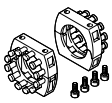
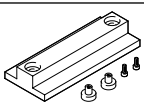
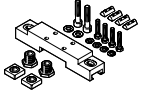
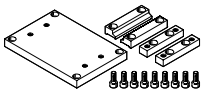
Designation	Description	Part no.	Type
<b>Mounting kit</b>			
	<ul style="list-style-type: none"> <li>Mounting kit for the energy chain and a Z-axis, such as EGSL, DGSL</li> </ul>	EXCM-30 4070088	EAHT-E9-FB-3D-30
<b>Adjusting kit</b>			
	<ul style="list-style-type: none"> <li>Height-adjustable mounting kit</li> </ul>	EXCM-30 4070088	EADC-E11-30
<b>Sensor mounting</b>			
	<ul style="list-style-type: none"> <li>For homing in combination with third-party motors</li> </ul>	EXCM-30 4070088	EAPR-E11-30
<b>Sensor mounting</b>			
	<ul style="list-style-type: none"> <li>For mounting the proximity switches SIES-Q8B, SIES-V3B on the X-axis</li> </ul>	EXCM-40, EXCH-40 2536353	EAPR-E12-40
		EXCH-60 2478805	EAPR-E12-60
<b>Energy chain</b>			
	<ul style="list-style-type: none"> <li>As a cable guide for the Z-axis</li> </ul>	EXCM-30 8059999 8060324	EADH-U-3D-30 EADH-U-3D-40
<b>Connection kit</b>			
	<ul style="list-style-type: none"> <li>Retaining brackets for mounting the energy chain</li> </ul>	EXCM-30 8060325 8060326	EAHT-AE-3D-30 EAHT-AE-3D-40
<b>Adjusting tool</b>			
	<ul style="list-style-type: none"> <li>For aligning and checking the flatness of the planar surface gantry</li> </ul>	EXCM-40, EXCH-40, EXCH-60 3197697	EADT-W-E12
<b>Adjusting kit</b>			
	<ul style="list-style-type: none"> <li>Used to mount the handling system on the supporting surface</li> <li>Can be used to easily compensate for any unevenness in the bearing surface</li> </ul>	EHMX-...-EGC-50-TB-KF 8047565	EADC-E15-50-E7
		EHMX-...-EGC-80-TB-KF 8047566	EADC-E15-80-E7
		EHMX-...-EGC-120-TB-KF 8047567	EADC-E15-120-E7
		EHMX-...-EGC-185-TB-KF 8047568	EADC-E15-185-E7
		EHMX-...-ELGC-60-BS 8142650	EADC-E15-60-E22
		EHMX-...-ELGC-80-BS 8142651	EADC-E15-80-E22
<b>Profile mounting</b>			
	<ul style="list-style-type: none"> <li>Used to mount the handling system on the supporting surface</li> <li>It is not height-adjustable</li> </ul>	EHMX-...-ELGC-60-BS 8142652	EAHM-E15-60-E22
		EHMX-...-ELGC-80-BS 8142653	EAHM-E15-80-E22

## Programming support

### Festo Automation Suite

Parameterisation and programming software for electronic devices from Festo

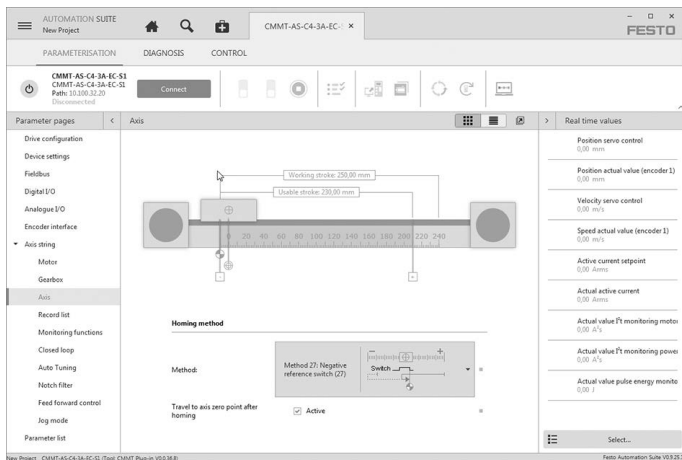

- Parameterisation, programming and commissioning in a clear and user-friendly interface
- Optimum support for complex processes thanks to guided wizards (e.g. for commissioning, drive configuration, etc.)
- Fast access to the required documents and additional information
- Easy integration of electric drives in the controller programming