

Three-dimensional gantries

FESTO

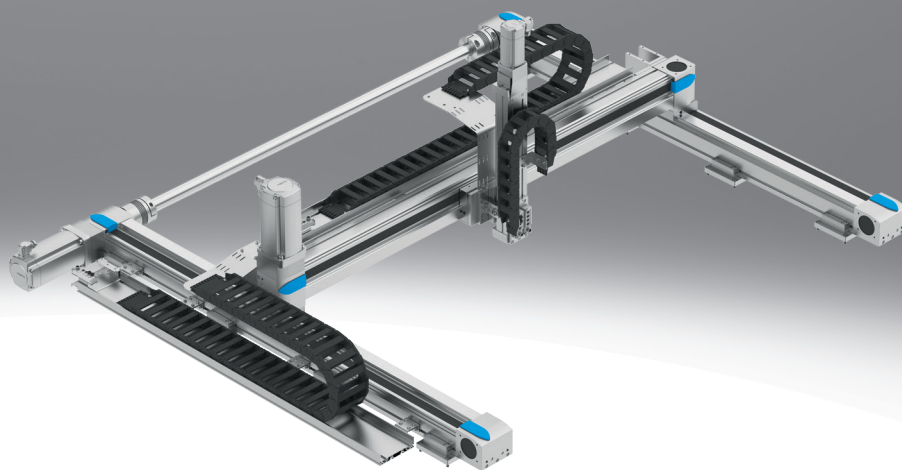

Key features

At a glance

The three-dimensional gantry facilitates movement in 3D space. Depending on the requirements, the gantry is either composed of several axis modules (YXCR) or using the planar surface gantries EXCM or EXCH (YXMR). These are all tried-and-tested components from Festo.

- Can be used generally for light to very heavy workpieces or high payloads
- Especially suitable for very long strokes
- High mechanical rigidity and sturdy design
- Pneumatic and electric components are freely combinable
- As an electrical solution it is freely positionable/any intermediate positions

Range of applications:

- For any movements in 3D space
- Very demanding requirements for precision and/or very heavy workpieces combined with long strokes (YXCR)
- Cost-effective handling unit in a compact format for small parts handling and simple tasks (YXCR-B)

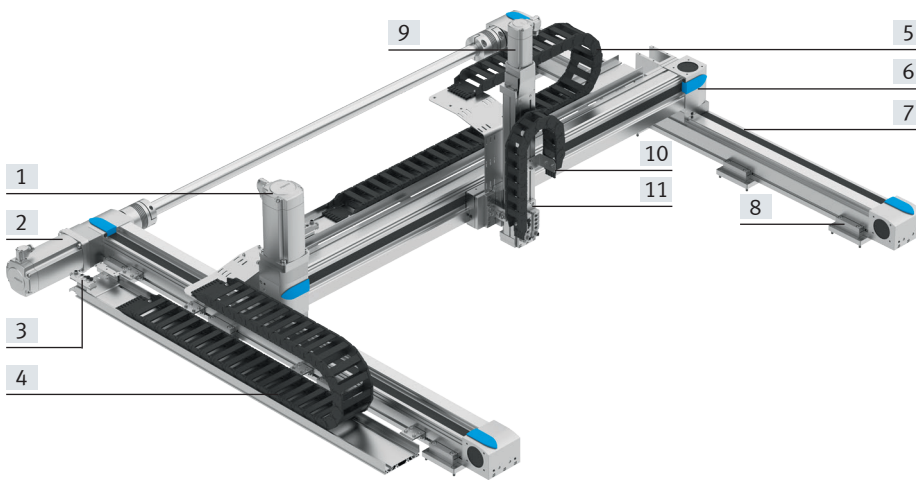

- [1] Servo motor for the Y-module
- [2] Servo motor for the X-module
- [3] Multi-pin plug distributor which transfers all electrical signals such as for end-position sensing
- [4] Energy chain for the X-module
- [5] Energy chain for the Y-module
- [6] Y-axis
- [7] X-axis
- [8] Profile mounting/adjusting kit
- [9] Servo motor for the Z-module
- [10] Energy chain for the Z-module
- [11] Z-axis

Description of the modules

X module

Design:

Depending on the configuration, the X-module comprises either two drive axes joined together by a connecting shaft (YXCR) or one drive axis + separate guide axis (YXCR-B).

They are powered by a servo or stepper motor.

Adapters are mounted on the slides of the X-axes to connect the Y-module.

The position of the motor and energy chain can be selected using the configurator.

The following components are located on the motor side:

- Energy chain (optional)
- Multi-pin plug distributor for proximity switch (if a sensor package has been selected)

Sample image:

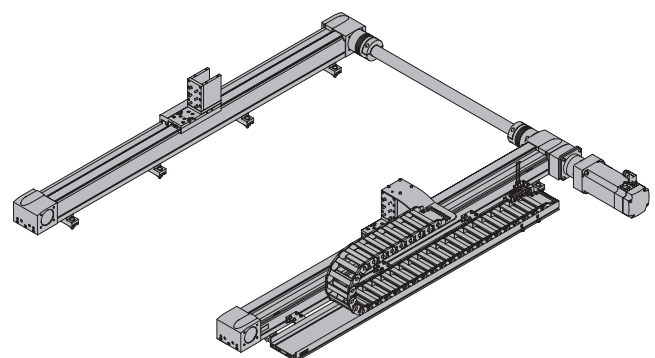

Key features

Description of the modules

Y-module

Design:

The Y-module EHYM comprises a linear axis which is powered by a servo or stepper motor.

Adapters are mounted on the slides of the Y-axis to connect the Z-module.

The position of the motor and energy chain is dependent on the position of the motor on the X-module.

The following components are located on the motor side:

- Energy chain (optional)
- Multi-pin plug distributor for proximity switch (if a sensor package has been selected)

Sample image:

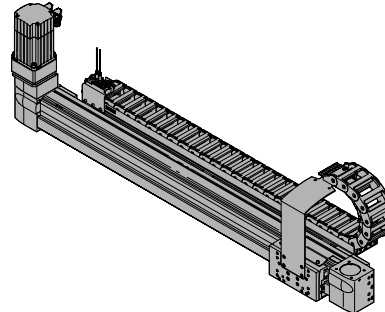

Z-module

Design:

The Z-module EHZM comprises an electric drive, the DHMZ comprises a pneumatic drive. Based on the configuration, an energy chain is optionally installed as a cable guide depending on the axis type and stroke.

The Z-module can be selected using the configurator, depending on the application.

Sample image:

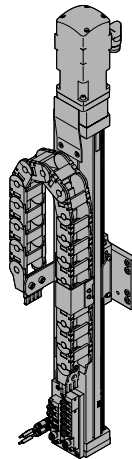

XY-module (EXCM, EXCH)

Design:

A slide is moved in a two-dimensional space (X-axis/Y-axis) via a toothed belt. The system is powered by two fixed motors. The motors are coupled to the toothed belt. The belt is guided via guide pulleys so that the slide can move to any position in a working space when the motors are actuated accordingly.

When using attachment components, additional processes can be carried out by independent Z-axes.

Sample image:

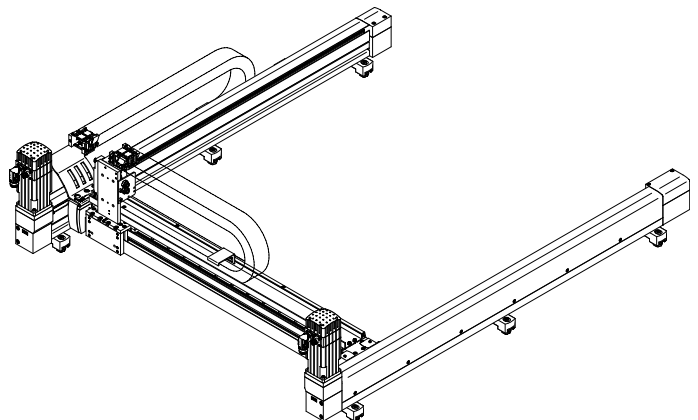

Key features

Description of the modules

Z-module (EXCM, EXCH)

Design:

The Z-module comprises either an electric drive (EHMZ) or a pneumatic drive (DHMZ).

The Z-module can be selected using the configurator, depending on the application.

Sample image:

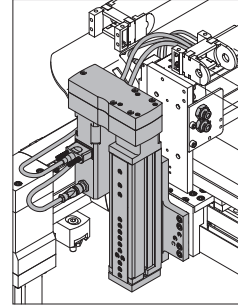
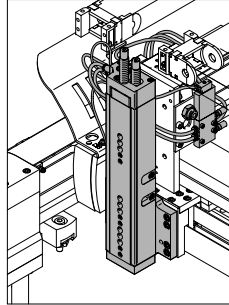

Dispatch options

Fully assembled:

The three-dimensional gantry is fully assembled. All cables and tubing are installed and connected. The system is already set up on delivery, but must be adapted to the particular mounting surface during installation.

Note flatness → table below.

Partially assembled:

The three-dimensional gantry is delivered partially assembled. This means that all three axis modules (X-/Y-/Z-axis) are assembled, each with the optional motors. The partially assembled system must be completed by the customer. Help can be found in the assembly instructions provided.

Optional accessories (→ page 12) are enclosed.

Note flatness → table below.

System overview¹⁾

Size	YXCR-1	YXCR-2	YXCR-3	YXCR-4
Max. working stroke	X: 1900 mm Y: 1800 mm Z: 50 mm	X: 3000 mm Y: 1820 mm Z: 1000 mm	X: 3000 mm Y: 1755 mm Z: 1200 mm	X: 3000 mm Y: 1640 mm Z: 1200 mm
Max. payload	Dependent on the selected dynamic response			
Required flatness of the mounting surface	≤ 0.1 mm/m			
Mounting position	Horizontal			

Size	YXCR-1-B	YXCR-2-B
Max. working stroke	X: 800 mm Y: 600 mm Z: 150 mm	X: 1000 mm Y: 800 mm Z: 200 mm
Max. payload	Dependent on the selected dynamic response	
Required flatness of the mounting surface	≤ 0.1 mm/m	
Mounting position	Horizontal	

Size	YXMR-1	YXMR-2	YXMR-3
Max. working stroke	X: 700 mm Y: 510 mm Z: 100 mm (electric) 150 mm (pneumatic)	X: 2000 mm Y: 1000 mm Z: 200 mm (electric) 150 mm (pneumatic)	X: 2500 mm Y: 1500 mm Z: 200 mm
Max. payload	Dependent on the selected dynamic response		
Required flatness of the mounting surface	≤ 0.1 mm/m		
Mounting position	Horizontal		

1) Drive package depends on the configuration selected.

Key features

Configurator: Handling Guide Online (HGO)

Selecting a handling system

Planning complex handling systems takes a lot of time. You can use the configurator "Handling Guide Online" (HGO) to design a customised handling system for your application in just a few steps.

You can choose from the following systems:





- Single-axis system
- 2D linear gantry
- 2D planar surface gantry
- Three-dimensional gantry
- 3D cantilever system

Advantages:

- Automatic selection of all relevant components
- Automatic design and calculation of the workload
- Quote created automatically
- CAD model available immediately
- Configuration-specific parameters for servo drives available immediately
- Complete Eplan project can be ordered according to the individual configuration
- Fully automated processing
- You can order fully or partially assembled systems through the Online Shop
- Lots of possible options

Selecting the handling solution

Select your handling system

<input type="radio"/> Single-axis system		<p>Single-axis movement: Single-axis module as a complete system. Easy to connect to your own front unit.</p> <p><input type="checkbox"/> Animation</p>
<input type="radio"/> 2D linear gantry		<p>Movements in 2D in the vertical working space: Linear gantries as complete systems. Electric and pneumatic axes can be combined</p> <p><input type="checkbox"/> Animation</p>
<input type="radio"/> 2D gantry		<p>Movements in 2D in the horizontal working space: Planar surface gantries as complete systems. Combining electric axes. Easy to connect to your own Z unit.</p> <p><input type="checkbox"/> Animation</p>
<input type="radio"/> 3D gantry		<p>Movements in 3D: Three-dimensional gantries as complete systems. Electric and pneumatic axes can be combined</p> <p><input type="checkbox"/> Animation</p>
<input type="radio"/> 3D cantilever system		<p>Movements in 3D: Cantilever system as complete system. Electric and pneumatic axes can be combined</p>

Entering the application data

- Payload
- Drive system of the axis
- Distance from the centre of the load
- Working stroke
- Reference cycle

Axis definition and payload

Axis definition

Drive system of the axis	X	Electric: several positions
	Y	Electric: several positions
	Z	Electric: several positions <input type="button" value="v"/>
Required working stroke	i X	<input type="text" value="100"/> mm
	i Y	<input type="text" value="120"/> mm
Working stroke in Z direction	i Z	<input type="text" value="50"/> mm
Take the stroke reserve into account in your specification		
Payload		
Sum of the weight of the front unit and the workpiece		<input type="text" value="2"/> kg
Distance from the centre of the load	i X	<input type="text"/> mm
	i Y	<input type="text"/> mm
	i Z	<input type="text"/> mm

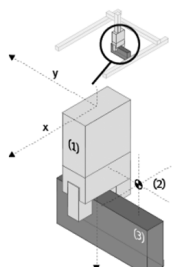
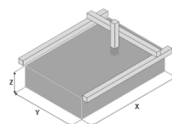

Data protection

Key features

Configurator: Handling Guide Online (HGO)

Result of calculation

You will be offered a selection of systems that have been calculated based on the application data you entered.

The following are available immediately:

- CAD model
- Datasheet of the selected system
- Price information

Result of calculation

Select the appropriate system and continue with the configuration:

Selection Filter

No.	System series	System workload i	Repetition accuracy (+/-)	Your price
<input checked="" type="checkbox"/>	1 YXCR-1	91 %	0.11 mm	
<input type="checkbox"/>	3 YXCR-2	46 %	0.11 mm	
<input type="checkbox"/>	5 YXCR-2	52 %	0.11 mm	
<input type="checkbox"/>	7 YXCR-2	32 %	0.11 mm	
<input type="checkbox"/>	26 YXMR-2	48 %	0.1 mm	

Requires additional motion controller for interpolation (e.g. CPX-E-CEC-M1- ...)

3D gantry YXCR-1: #1

Drive module	X module: toothed belt axis EGC-50	Y module: toothed belt axis EGC-50	Z module: Electric mini slide EGSL-35
Kinematics type	Serial kinematics	Serial kinematics	Serial kinematics
Stroke	200 mm	200 mm	50 mm
Repetition accuracy (+/-)	0.08 mm	0.08 mm	0.02 mm
Gear unit	5:1	5:1	Without
Type of motor	Servo motor EMME-AS	Servo motor EMME-AS	Servo motor EMME-AS
Motor position	Right	Right	Top

Data protection

Back

Continue

System overview

You will be given an overview of the complete system.

- Show price
- Send request

You will also have the following options:

- Add to basket

Your handling solution

Your selected system overview:

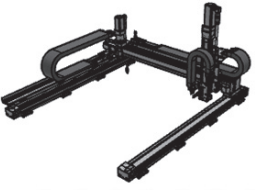

©2022 powered by CADENAS

Update CAD Preview

Your system ID:
C2534118

Your next step:

Show price

Send request

Add to Cart

Key features

Standard components within the handling system

The handling system comprises a number of tried-and-tested standard components from Festo. Different components are used depending on the configuration. The single axes installed will be displayed in the configurator HGO on the "Result of calculation" page.

Drives/axes

X-Axis

Toothed belt axis EGC-TB-KF



- Electrical
- Rigid, closed profile
- Recirculating ball bearing guide for high loads and torques
- High dynamic response and minimum vibration

Ball screw axis ELGC-BS



- Electrical
- Optimal installation space to working space ratio
- Protected against external influences by internal guide
- Various screw pitches

Guide axis ELFC



- Driveless linear guide unit with guide and freely movable slide unit
- The guide axis is designed to support forces and torques in multi-axis applications

Y-axis

Toothed belt axis EGC-TB-KF



- Electrical
- Rigid, closed profile
- Recirculating ball bearing guide for high loads and torques
- High dynamic response and minimum vibration

Ball screw axis ELGC-BS



- Electrical
- Optimal installation space to working space ratio
- Protected against external influences by internal guide
- Various screw pitches

Toothed belt axis EGC-HD-TB

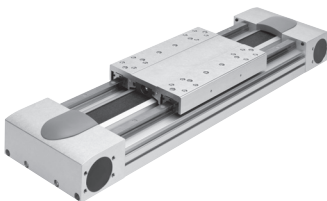

- Electrical
- Flat drive unit with rigid, closed profile
- Duo guide rail
- For maximum loads and torques, high feed forces and speeds and long service life

Key features

Standard components within the handling system

The handling system comprises a number of tried-and-tested standard components from Festo. Different components are used depending on the configuration. The single axes installed will be displayed in the configurator HGO on the "Result of calculation" page.

Z-axis

Mini slide EGSC



- Electrical
- Compact design
- High load capacity
- Precision guide and ball screw
- Easy adjustment of end positions

Mini slide EGSL

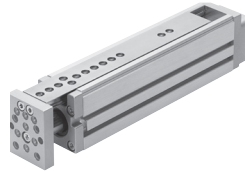

- Electrical
- Compact design
- High load capacity
- High dynamic response
- Easy adjustment of end positions

Mini slide DGST



- Pneumatic system
- Precise and resilient roller bearing guide
- Slide and yoke plate as a single component
- High dynamic response

Mini slide DGSL



- Pneumatic system
- Flat design
- High load capacity
- High dynamic response
- Easy adjustment of end positions

Spindle axis EGC-BS-KF



- Electrical
- Rigid, closed profile
- Recirculating ball bearing guide for high loads and torques
- High dynamic response and minimum vibration
- Various screw pitches

Cantilever axis ELCC

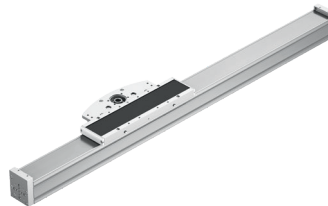

- Stationary drive head
- Toothed belt drive with recirculating ball bearing guide
- High rigidity thanks to the innovative design principle
- Very low moving mass

Key features

Possible axis combinations ¹⁾			
Size	X module	Y-module	Z-module
YXCR-1	<ul style="list-style-type: none"> Toothed belt axis EGC-50-TB-KF 	<ul style="list-style-type: none"> Toothed belt axis EGC-50-TB-KF 	<ul style="list-style-type: none"> Mini slide Pneumatic: DGSL-6 Electric: EGSL-35
YXCR-1-B	<ul style="list-style-type: none"> Ball screw axis ELGC-60-BS 	<ul style="list-style-type: none"> Ball screw axis ELGC-45-BS Ball screw axis ELGC-60-BS 	<ul style="list-style-type: none"> Mini slide pneumatic: DGST-8/12/16 electric: EGSC-32/45
YXCR-2	<ul style="list-style-type: none"> Toothed belt axis EGC-80-TB-KF 	<ul style="list-style-type: none"> Toothed belt axis EGC-80-TB-KF Toothed belt axis with heavy-duty guide EGC-HD-125-TB 	<ul style="list-style-type: none"> Mini slide Pneumatic: DGSL-12/16 Electric: EGSL-45/55 Cantilever axis ELCC-60 Ball screw axis EGC-70-BS-KF
YXCR-2-B	<ul style="list-style-type: none"> Ball screw axis ELGC-80-BS 	<ul style="list-style-type: none"> Ball screw axis ELGC-60-BS Ball screw axis ELGC-80-BS 	<ul style="list-style-type: none"> Mini slide Pneumatic: DGST-12/16/20 Electric: EGSC-45/60
YXCR-3	<ul style="list-style-type: none"> Toothed belt axis EGC-120-TB-KF 	<ul style="list-style-type: none"> Toothed belt axis EGC-120-TB-KF Toothed belt axis with heavy-duty guide EGC-HD-160-TB 	<ul style="list-style-type: none"> Mini slide Pneumatic: DGSL-20/25 Electric: EGSL-75 Cantilever axis ELCC-70 Ball screw axis EGC-80-BS-KF
YXCR-4	<ul style="list-style-type: none"> Toothed belt axis EGC-185-TB-KF 	<ul style="list-style-type: none"> Toothed belt axis EGC-185-TB-KF Toothed belt axis with heavy-duty guide EGC-HD-220-TB 	<ul style="list-style-type: none"> Cantilever axis ELCC-90 Ball screw axis EGC-120-BS-KF
YXMR-1	<ul style="list-style-type: none"> Planar surface gantry EXCM-30 	<ul style="list-style-type: none"> Planar surface gantry EXCM-30 	<ul style="list-style-type: none"> Mini slide Pneumatic: DGSL-8/10/12 Electric: EGSC-25/32
YXMR-2	<ul style="list-style-type: none"> Planar surface gantry EXCM-40, EXCH-40 	<ul style="list-style-type: none"> Planar surface gantry EXCM-40, EXCH-40 	<ul style="list-style-type: none"> Mini slide Pneumatic: DGSL-16 Electric: EGSL-45
YXMR-3	<ul style="list-style-type: none"> Planar surface gantry EXCH-60 	<ul style="list-style-type: none"> Planar surface gantry EXCH-60 	<ul style="list-style-type: none"> Mini slide Pneumatic: DGSL-20 Electric: EGSL-55

1) Drive package depends on the configuration selected.

Key features

Standard components within the handling system

The handling system comprises a number of tried-and-tested standard components from Festo. Different components are used depending on the configuration. You can alter the scope and design of the drive package in the configurator HGO on the "System configuration" page.

Motors and controllers

Servo motors EMMT-AS



- Dynamic, brushless, permanently excited servo motor
- Digital absolute displacement encoder in single-turn or multi-turn version
- Simple connection technology (OCP: one cable plug) – hybrid cable: motor cable and connecting cable for supply and encoder in one
- Plug can be rotated 310°
- With optional brake

Servo motors EMMB-AS



- Dynamic, brushless, permanently excited servo motor
- Digital absolute displacement encoder in single-turn or multi-turn version
- Optimised connection technology
- With optional brake

Stepper motors EMMT-ST

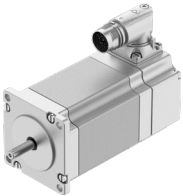

- Two-phase hybrid technology
- Digital absolute displacement encoder in single-turn or multi-turn version
- Simple connection technology (OCP: one cable plug) – hybrid cable: motor cable and connecting cable for supply and encoder in one
- Plug can be rotated 310°
- With optional brake

Stepper motors EMMB-ST

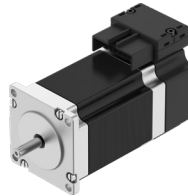

- Two-phase hybrid technology
- Digital absolute displacement encoder in single-turn or multi-turn version
- Simple connection technology (OCP: one cable plug) – hybrid cable: motor cable and connecting cable for supply and encoder in one
- Can be positioned to the front or the rear
- With optional brake

Gear unit EMGA

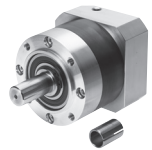

- Low-backlash planetary gear
- Gear ratio
 $i = 3$ and 5
- Life-time lubrication

Key features

Standard components within the handling system

The handling system comprises a number of tried-and-tested standard components from Festo. Different components are used depending on the configuration. You can alter the scope and design of the drive package in the configurator HGO on the "System configuration" page.

Servo drive CMMT-AS, for servo motor



- Universal servo drive
- For synchronous servo motors
- Integrated EMC filters
- Integrated brake chopper
- Integrated braking resistor
- Position controller
- Speed controller
- Force controller
- Range of control functions

Options:

- Safety function: safe torque off (STO)/category 4, Performance Level e
- Safe stop 1 (SS1)
- Safe brake control (SBC) up to SIL3/category 3, Performance Level e

- Bus protocols
 - EtherCAT®
 - PROFINET RT/IRT
 - EtherNet/IP
 - Modbus TCP

Servo drive CMMT-ST, for stepper motor



- Servo drive for operating stepper motors and brushless direct current motors
- Options for point-to-point and interpolating motion and for precise positioning
- Primary voltage from 24 ... 48 V DC
- Position controller
- Speed controller
- Force controller
- Range of control functions

Options:

- Safety function: safe torque off (STO)/category 3, Performance Level e
- Safe stop 1 time controlled (SS1-t)

- Bus protocols
 - EtherCAT®
 - PROFINET RT/IRT
 - EtherNet/IP
 - Modbus TCP

Ordering data – Accessories

Module/motor combinations

We recommend that the three-dimensional gantry is operated with the suggested motors from Festo. These precisely match the mechanical system. When using third-party motors, it is essential that the technical limits are observed.

Module	Motor		Stepper motor	
	Servo motor			
X module				
EHM-EGC-50-TB-KF	–	–	EMMT-ST-42-L-...	EMMB-ST-42-L-...
EHM-EGC-80-TB-KF	EMMT-AS-60-L-LS-...	–	EMMT-ST-57-L-...	EMMB-ST-57-L-...
	EMMT-AS-100-M-HS-...			
EHM-EGC-120-TB-KF	EMMT-AS-80-L-LS-...	–	–	–
	EMMT-AS-80-L-HS-...			
EHM-EGC-185-TB-KF	EMMT-AS-100-L-HS-...	–	–	–
	EMMT-AS-100-H-HS-...	–	–	–
	EMMT-AS-150-M-HS-R2...	–	–	–
EHM-ELGC-60-BS	–	EMMB-AS-80-07	EMMT-ST-57-L-...	EMMB-ST-57-L-...
EHM-ELGC-80-BS	–	EMMB-AS-80-07	EMMT-ST-87-M-...	EMMB-ST-87-M-...
Y-module				
EHM-...-EGC-50-TB-KF	–	–	EMMT-ST-57-L-...	EMMB-ST-57-L-...
EHM-...-EGC-80-TB-KF	EMMT-AS-60-S-LS-...	–	EMMT-ST-57-M-...	EMMB-ST-57-M-...
EHM-...-EGC-120-TB-KF	EMMT-AS-80-L-LS-...	–	–	–
	EMMT-AS-80-L-HS-...			
EHM-...-EGC-125-TB-HD	EMMT-AS-60-L-LS-...	–	EMMT-ST-57-M-...	EMMB-ST-57-M-...
EHM-...-EGC-160-TB-HD	EMMT-AS-80-M-LS-...	–	–	–
	EMMT-AS-80-L-HS-...			
EHM-...-EGC-185-TB-KF	EMMT-AS-100-L-HS-...	–	–	–
EHM-...-EGC-220-TB-HD	EMMT-AS-100-L-HS-...	–	–	–
EHM-RP-ELGC-45-BS	–	EMMB-AS-40-01	EMMT-ST-42-L-...	EMMB-ST-42-L-...
EHM-RP-ELGC-60-BS	–	EMMB-AS-60-04	EMMT-ST-57-L-...	EMMB-ST-57-L-...
EHM-RP-ELGC-80-BS	–	EMMB-AS-60-04	EMMT-ST-87-M-...	EMMB-ST-87-M-...
Z-module				
EHMZ-ELCC-60-TB-KF	EMMT-AS-60-M-LS-...	–	–	–
	EMMT-AS-80-L-LS-...	–	–	–
	EMMT-AS-100-S-HS-...	–	–	–
EHMZ-ELCC-70-TB-KF	EMMT-AS-80-M-LS-...	–	–	–
	EMMT-AS-80-L-HS-...	–	–	–
EHMZ-ELCC-90-TB-KF	EMMT-AS-80-L-HS-...	–	–	–
	EMMT-AS-100-L-HS-...	–	–	–
	EMMT-AS-100-H-HS-...	–	–	–
EHMZ-EGC-70-BS-KF	EMMT-AS-60-S-LS-...	–	EMMT-ST-57-M-...	EMMB-ST-57-M-...
EHMZ-EGC-80-BS-KF	EMMT-AS-60-M-LS-...	–	EMMT-ST-57-M-...	EMMB-ST-57-M-...
EHMZ-EGC-120-BS-KF	EMMT-AS-80-S-LS-...	–	–	–
	EMMT-AS-80-M-LS-...			
	EMMT-AS-80-S-HS-...			
	EMMT-AS-80-L-HS-...			
EHMZ-EGSL-35-BS-KF	–	–	EMMT-ST-42-S-...	EMMB-ST-42-S-...
EHMZ-EGSL-45-BS-KF	EMMT-AS-60-S-LS-...	–	EMMT-ST-57-M-...	EMMB-ST-57-M-...
EHMZ-EGSL-55-BS-KF	EMMT-AS-60-S-LS-...	–	EMMT-ST-57-M-...	EMMB-ST-57-M-...
EHMZ-EGSL-75-BS-KF	EMMT-AS-80-S-LS-...	–	EMMT-ST-87-S-...	EMMB-ST-87-S-...
EHMZ-EGSC-32	–	EMMB-AS-40-01	EMMT-ST-42-L-...	EMMB-ST-42-L-...
EHMZ-EGSC-45	–	EMMB-AS-40-01	EMMT-ST-42-L-...	EMMB-ST-42-L-...
EHMZ-EGSC-60	–	EMMB-AS-60-02	EMMT-ST-57-L-...	EMMB-ST-57-L-...

Ordering data – Accessories

Module	Motor		Stepper motor	
	Servo motor			
XY-module (EXCM, EXCH)				
EXCM-30	–	–	EMMT-ST-42-L-...	EMMB-ST-42-L-...
EXCM-40	–	–	EMMT-ST-87-S-...	EMMB-ST-87-S-...
EXCH-40	EMMT-AS-80-M-LS-...	–	–	
	EMMT-AS-80-L-HS-...	–	–	
EXCH-60	EMMT-AS-100-M-HS-...	–	–	
	EMMT-AS-150-M-HV-R3...	–	–	
Z-module (EXCM, EXCH)				
EHMZ-EGSC-BS-KF-32-...-V1	–	–	EMMT-ST-42-L-...	EMMB-ST-42-L-...
EHMZ-EGSL-45-BS-KF-...-V1	EMMT-AS-60-S-LS-...	–	–	
EHMZ-EGSL-55-BS-KF-...-V1	EMMT-AS-60-S-LS-...	–	–	

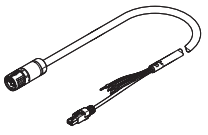
Ordering data				
Designation	Description	Cable length [m]	Part no.	Type
For servo motor EMMT-AS				
Motor cable				
	<ul style="list-style-type: none"> For EMMT-AS-60/80-...-R2... with CMMT-AS 	2.5	5251374	NEBM-M23G15-EH-2.5-Q7N-R3LEG14
		5	5251375	NEBM-M23G15-EH-5-Q7N-R3LEG14
		7.5	5251376	NEBM-M23G15-EH-7.5-Q7N-R3LEG14
		10	5251377	NEBM-M23G15-EH-10-Q7N-R3LEG14
		15	5251378	NEBM-M23G15-EH-15-Q7N-R3LEG14
		20	5251379	NEBM-M23G15-EH-20-Q7N-R3LEG14
	<ul style="list-style-type: none"> For EMMT-AS-100-...-R2... with CMMT-AS For EMMT-AS-150-...-R2... with CMMT-AS 	2.5	5251381	NEBM-M23G15-EH-2.5-Q9N-R3LEG14
		5	5251382	NEBM-M23G15-EH-5-Q9N-R3LEG14
		7.5	5251383	NEBM-M23G15-EH-7.5-Q9N-R3LEG14
		10	5251384	NEBM-M23G15-EH-10-Q9N-R3LEG14
		15	5251385	NEBM-M23G15-EH-15-Q9N-R3LEG14
	<ul style="list-style-type: none"> For EMMT-AS-150-...-R3... with CMMT-AS 	2.5	5251395	NEBM-M40G15-EH-2.5-Q11N-R3LEG14
		5	5251396	NEBM-M40G15-EH-5-Q11N-R3LEG14
		7.5	5251397	NEBM-M40G15-EH-7.5-Q11N-R3LEG14
		10	5251398	NEBM-M40G15-EH-10-Q11N-R3LEG14
15		5251399	NEBM-M40G15-EH-15-Q11N-R3LEG14	
	20	5251400	NEBM-M40G15-EH-20-Q11N-R3LEG14	

Ordering data – Accessories

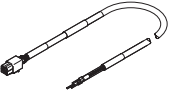
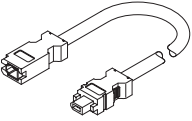
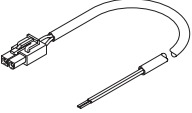
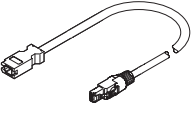
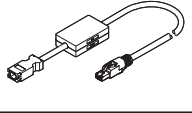
Ordering data		Cable length	Part no.	Type
Designation	Description	[m]		
For servo motor EMMB-AS				
Motor cable				
	<ul style="list-style-type: none"> For EMMB-AS-40/60/80 with CMMT-AS 	2.5	5219197	NEBM-H6G4-E-2.5-Q13N-LE4
		5	5219198	NEBM-H6G4-E-5-Q13N-LE4
		7.5	5219199	NEBM-H6G4-E-7.5-Q13N-LE4
		10	5219200	NEBM-H6G4-E-10-Q13N-LE4
		15	8097203	NEBM-H6G4-E-15-Q13N-LE4
Encoder cable				
	<ul style="list-style-type: none"> For EMMB-AS-40/60/80 with CMMT-AS 	2.5	5219213	NEBM-REG6-E-2.5-Q14N-REG6
		5	5219214	NEBM-REG6-E-5-Q14N-REG6
		7.5	5219215	NEBM-REG6-E-7.5-Q14N-REG6
		10	5219216	NEBM-REG6-E-10-Q14N-REG6
		15	8097200	NEBM-REG6-E-15-Q14N-REG6
Connecting cable for brake				
	<ul style="list-style-type: none"> For EMMB-AS-40/60/80 with CMMT-AS 	2.5	5219205	NEBM-H7G2-E-2.5-Q14N-LE2
		5	5219206	NEBM-H7G2-E-5-Q14N-LE2
		7.5	5219207	NEBM-H7G2-E-7.5-Q14N-LE2
		10	5219208	NEBM-H7G2-E-10-Q14N-LE2
		15	8097206	NEBM-H7G2-E-15-Q14N-LE2
Adapter for encoder cable (absolutely essential)				
	<ul style="list-style-type: none"> For EMMB-AS-40/60/80 with CMMT-AS 	For single-turn version with CMMT-AS		
		0.5	8097197	NEFM-REG6-K-0.5-R3G8
	<ul style="list-style-type: none"> For EMMB-AS-40/60/80 with CMMT-AS 	For multi-turn version with CMMT-AS¹⁾		
		0.5	8097195	NEFM-REG6-K-0.5-B-R3G8
		For multi-turn version with CMMB-AS¹⁾		
		0.5	8097196	NEFM-REG6-K-0.5-B-REG6

1) The required battery is not included in the scope of delivery

Ordering data – Accessories

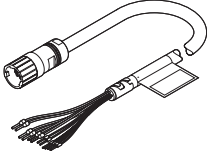
Designation	Description	Cable length [m]	Part no.	Type
For stepper motor EMMT-ST				
Motor cable				
	• For EMMT-ST-42-... with CMMT-ST	2.5	8181670	NEBM-M17G12-EH-2.5-Q6N-LE12
		5	8181668	NEBM-M17G12-EH-5-Q6N-LE12
		7	8190096	NEBM-M17G12-EH-7.5-Q6N-LE12
		10	8195457	NEBM-M17G12-EH-10-Q6N-LE12
		15	8214679	NEBM-M17G12-EH-15-Q7N-LE12
	• For EMMT-ST-57-... with CMMT-ST	2.5	8181670	NEBM-M17G12-EH-2.5-Q6N-LE12
		5	8181668	NEBM-M17G12-EH-5-Q6N-LE12
		7	8195460	NEBM-M17G12-EH-7.5-Q7N-LE12
		10	8195461	NEBM-M17G12-EH-10-Q7N-LE12
		15	8214683	NEBM-M17G12-EH-15-Q9N-LE12
	• For EMMT-ST-87-... with CMMT-ST	2.5	8195458	NEBM-M17G12-EH-2.5-Q7N-LE12
		5	8195459	NEBM-M17G12-EH-5-Q7N-LE12
		7	8214681	NEBM-M17G12-EH-7.5-Q9N-LE12
		10	8214682	NEBM-M17G12-EH-10-Q9N-LE12
		15	8214683	NEBM-M17G12-EH-15-Q9N-LE12

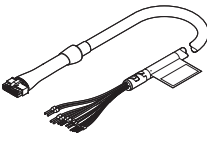
Designation	Description	Cable length [m]	Part no.	Type
For stepper motor EMMB-ST				
Motor cable				
	• For EMMB-ST-42-... with CMMT-ST	2.5	8181675	NEBM-L5G14-EH-2.5-Q6N-LE12
		5	8181664	NEBM-L5G14-EH-5-Q6N-LE12
		7	8181676	NEBM-L5G14-EH-7.5-Q6N-LE12
		10	8181672	NEBM-L5G14-EH-10-Q6N-LE12
		15	8214680	NEBM-L5G14-EH-15-Q6N-LE12
	• For EMMB-ST-57-... with CMMT-ST	2.5	8181677	NEBM-L10G14-EH-2.5-Q6N-LE12
		5	8181667	NEBM-L10G14-EH-5-Q6N-LE12
		7	8181674	NEBM-L10G14-EH-7.5-Q7N-LE12
		10	8181673	NEBM-L10G14-EH-10-Q7N-LE12
		15	8214689	NEBM-L10G14-EH-15-Q9N-LE12
	• For EMMB-ST-87-... with CMMT-ST	2.5	8181666	NEBM-L10G14-EH-2.5-Q7N-LE12
		5	8181671	NEBM-L10G14-EH-5-Q7N-LE12
		7	8214687	NEBM-L10G14-EH-7.5-Q9N-LE12
		10	8214688	NEBM-L10G14-EH-10-Q9N-LE12
		15	8214689	NEBM-L10G14-EH-15-Q9N-LE12

Possible cable and tube lengths



- Cables and tubing are selected so that the length specified when ordering will be the minimum connection length from the energy chain output.
- Cables and tubing are only available in fixed lengths as stated in the table below. This can mean that the cable plugs of the different cables do not end at the same point.

Length	1 m	2 m	5 m	7 m	10 m
Motor cable	–	■	■	■	■
Encoder cable	–	■	■	■	■
Multi-pin plug connecting cable	–	■	■	■	■
Tubing (for DHMZ only)	■	■	■	–	–

Ordering data – Accessories

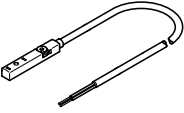

Standard components within the handling system

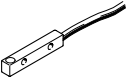
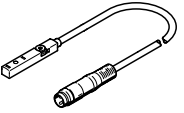
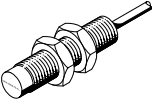
The handling system comprises a number of tried-and-tested standard components from Festo. Different components are used depending on the configuration. You can alter the scope and design of the accessories in the configurator HGO on the "System configuration" page.

Designation	Description	Cable length [m]	Part no.	Type	
Proximity switch (inductive) for sensing the position of the slide on the X-/Y-/Z-axis					
	Cable with open end				
	<ul style="list-style-type: none"> For toothed belt axis EGC-TB, EGC-HD-TB For ball screw axis EGC-BS For ball screw axis ELGC-BS For mini slide EGSL For mini slide EGSC For DC voltage Included if the "Festo sensor package" is selected: <ul style="list-style-type: none"> For EGC, ELGC: 2 pieces For EGSL, EGSC: 1 piece 	PNP, N/C contact	7.5	551391	SIES-8M-PO-24V-K-7.5-OE
		PNP, N/O contact	7.5	551386	SIES-8M-PS-24V-K-7.5-OE
		NPN, N/C contact	7.5	551401	SIES-8M-NO-24V-K-7.5-OE
		NPN, N/O contact	7.5	551396	SIES-8M-NS-24V-K-7.5-OE
Proximity switches for sensing the position of the slide on the X-axis					
	<ul style="list-style-type: none"> For EXCM-40, EXCH-40, EXCH-60 PNP, N/O contact	–	150491	SIES-V3B-PS-S-L	
	<ul style="list-style-type: none"> For EXCM-40, EXCH-40, EXCH-60 PNP, N/C contact Included if the "Festo sensor package" is selected: <ul style="list-style-type: none"> 1 piece 	–	174552	SIES-Q8B-PO-K-L	
Proximity switch (inductive) for sensing the position of the slide on the Y-axis					
	Cable with plug				
	<ul style="list-style-type: none"> For EXCM-40, EXCH-40, EXCH-60 For DC voltage Included if the "Festo sensor package" is selected: <ul style="list-style-type: none"> 1 piece 	PNP, N/C contact	0.3	551392	SIES-8M-PO-24V-K-0.3-M8D
		PNP, N/O contact	0.3	551387	SIES-8M-PS-24V-K-0.3-M8D
Proximity switch (inductive) for sensing the position of the slide on the Z-axis					
	Cable with open end				
	<ul style="list-style-type: none"> For cantilever axis ELCC For DC voltage Included if the "Festo sensor package" is selected: <ul style="list-style-type: none"> 2 pieces 	PNP, N/C contact	2.5	150398	SIEN-M8NB-PO-K-L
		PNP, N/O contact	2.5	150394	SIEN-M8NB-PS-K-L
		NPN, N/C contact	2.5	150396	SIEN-M8NB-NO-K-L
NPN, N/O contact		2.5	150392	SIEN-M8NB-NS-K-L	

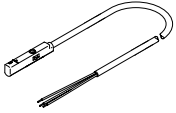
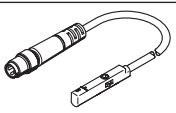
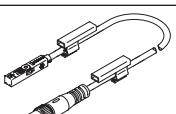

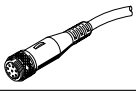
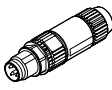
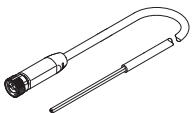
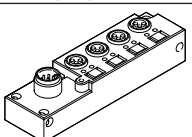
Ordering data – Accessories

Designation	Description	Cable length [m]	Part no.	Type	
Proximity switches (magneto-resistive) for sensing the position of the slide on the Z-axis					
	Cable with open end <ul style="list-style-type: none"> For mini slide DGSL For DC voltage Included if the "Festo sensor package" is selected: <ul style="list-style-type: none"> 2 pieces 	PNP, N/O contact	2.5	551373	SMT-10M-PS-24V-E-2.5-L-OE
		NPN, N/O contact	2.5	551377	SMT-10M-NS-24V-E-2.5-L-OE
	<ul style="list-style-type: none"> For mini slide DGST-8/-12 For DC voltage Included if the "Festo sensor package" is selected: <ul style="list-style-type: none"> 2 pieces 	PNP, N/O contact	2.5	551375	SMT-10M-PS-24V-E-0.3-L-M8D
		NPN, N/O contact	2.5	551379	SMT-10M-NS-24V-E-0.3-L-M8D
	<ul style="list-style-type: none"> For mini slide DGST-16/-20 For DC voltage Included if the "Festo sensor package" is selected: <ul style="list-style-type: none"> 2 pieces 	PNP, N/O contact	2.5	574334	SMT-8M-A-PS-24V-E-0.3-M8D
		NPN, N/O contact	2.5	574339	SMT-8M-A-NS-24V-E-0.3-M8D

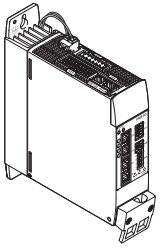
Designation	Description	Cable length [m]	Part no.	Type
Plug socket with cable				
	<ul style="list-style-type: none"> Connection between multi-pin plug distributor NEDU and control cabinet 	5	525618	SIM-M12-8GD-5-PU
		10	570008	SIM-M12-8GD-10-PU
Plug				
	<ul style="list-style-type: none"> For connection to the multi-pin plug distributor NEDU / distributor NEDY 	–	562024	NECU-S-M8G3-HX
Connecting cable				
	<ul style="list-style-type: none"> Connection between distributor NEDY and control cabinet 	2.5	8078227	NEBA-M8G4-U-2.5-N-LE4
		5	8078228	NEBA-M8G4-U-5-N-LE4
		7.5	8215486	NEBA-M8G4-U-7.5-N-LE4
		10	8078229	NEBA-M8G4-U-10-N-LE4
		15	8215487	NEBA-M8G4-U-15-N-LE4
Multi-pin plug distributor				
	<ul style="list-style-type: none"> With the help of the multi-pin plug distributor, all electrical signals such as for end-position sensing can be transferred Options: <ul style="list-style-type: none"> 4 individual connections 6 individual connections 	–	574586	NEDU-L4R1-M8G3L-M12G8
			574587	NEDU-L6R1-M8G3L-M12G8
	<ul style="list-style-type: none"> With the help of the distributor, all electrical signals such as for end-position sensing can be transferred 2 individual connections 	–	8005312	NEDY-L2R1-V1-M8G3-N-M8G4

Designation	Description
Motor controller/servo drive	
	The accessories for the relevant motor controllers/servo drives can be found at: <ul style="list-style-type: none"> www.festo.com/catalogue/cmmt

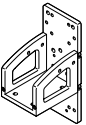
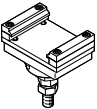
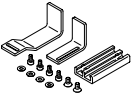
Ordering data – Accessories

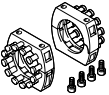
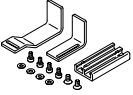
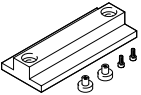
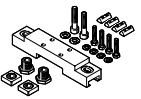
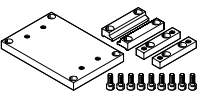
Designation	Description	Part no.	Type
Mounting kit			
	<ul style="list-style-type: none"> Mounting kit for the energy chain and a Z-axis, such as EGSL, DGSL 	EXCM-30	4070088 EAHT-E9-FB-3D-30
Adjusting kit			
	<ul style="list-style-type: none"> Height-adjustable mounting kit 	EXCM-30	4070088 EADC-E11-30
Sensor mounting			
	<ul style="list-style-type: none"> For homing in combination with third-party motors 	EXCM-30	4070088 EAPR-E11-30
Energy chain			
	<ul style="list-style-type: none"> As a cable guide for the Z-axis 	EXCM-30	8059999 EADH-U-3D-30 8060324 EADH-U-3D-40
Connection kit			
	<ul style="list-style-type: none"> Retaining brackets for mounting the energy chain 	EXCM-30	8060325 EAHT-AE-3D-30 8060326 EAHT-AE-3D-40
Sensor mounting			
	<ul style="list-style-type: none"> For mounting the proximity switches SIES-Q8B, SIES-V3B on the X-axis 	EXCM-40, EXCH-40 EXCH-60	2536353 EAPR-E12-40 2478805 EAPR-E12-60
Adjusting tool			
	<ul style="list-style-type: none"> For aligning and checking the flatness of the planar surface gantry 	EXCM-40, EXCH-40, EXCH-60	3197697 EADT-W-E12
Adjusting kit			
	<ul style="list-style-type: none"> Used to mount the handling system on the supporting surface Can be used to easily compensate for any unevenness in the bearing surface 	EHMx-....-EGC-50-TB-KF EHMx-....-EGC-80-TB-KF EHMx-....-EGC-120-TB-KF EHMx-....-EGC-185-TB-KF EHMx-....-ELGC-60-BS EHMx-....-ELGC-80-BS	8047565 EADC-E15-50-E7 8047566 EADC-E15-80-E7 8047567 EADC-E15-120-E7 8047568 EADC-E15-185-E7 8142650 EADC-E15-60-E22 8142651 EADC-E15-80-E22
Profile mounting			
	<ul style="list-style-type: none"> Used to mount the handling system on the supporting surface It is not height-adjustable 	EHMx-....-ELGC-60-BS EHMx-....-ELGC-80-BS	8142652 EAHM-E15-60-E22 8142653 EAHM-E15-80-E22

Programming aid

Festo Automation Suite

Parameterisation and programming software for electronic devices from Festo

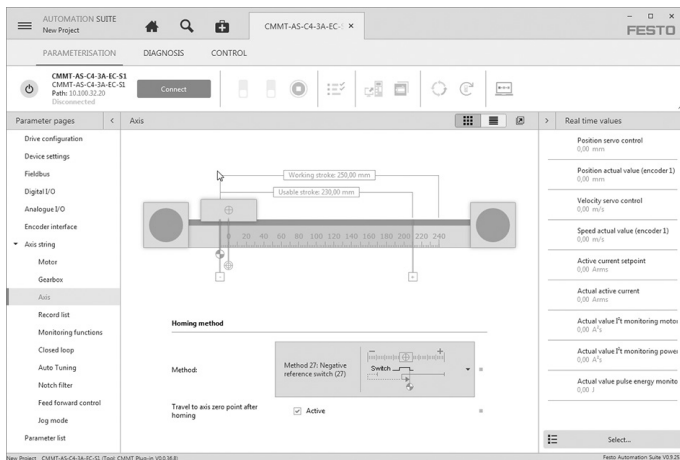

- Parameterisation, programming and commissioning in a clear and user-friendly interface
- Optimum support for complex processes thanks to guided wizards (e.g. for commissioning, drive configuration, etc.)
- Fast access to the required documents and additional information
- Easy integration of electric drives in the controller programming