

Customised tubing PAN, PEN, PLN, PUN

FESTO



Characteristics

At a glance

Customised tubing PUN, PAN, PEN, PLN for different requirements for pressure, temperature, flexibility and environmental influences.

- PUN: polyurethane tubing; very resistant to stress cracks; suitable for energy chains; operating media: compressed air, vacuum
- PAN: polyamide tubing; thermally and mechanically highly resilient; very resistant to microbes; operating media: compressed air, vacuum
- PEN: polyethylene tube; highly resistant to chemicals and extremely resistant to hydrolysis; largely resistant to common cleaning agents and lubricants; suitable for energy chains; operating media: compressed air, vacuum, water (for water, see manufacturer's declaration at www.festo.com/certificates/PEN_S)
- PLN: polyethylene tube; highly resistant to chemicals, microbes and hydrolysis; for suitability in the food industry, see www.festo.com/certificates/PLN; operating media: compressed air, vacuum, water (for water according to manufacturer's declaration, see www.festo.com/certificates/PLN)

Ordering data - modular system

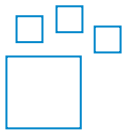

This product and all its product options can be ordered online via the configurator.

- Individual lengths: delivered in units of 25, 50, 100, 200 ... 500 m
- Minimum order quantity: from 1500 m/3000 m (or less depending on type) depending on diameter
- Customised design: specific printing possible
- Individual colour selection for easier recognition and handling
- 9 basic colours, other colours available on request
- Select, size and order quickly, easily and reliably with the configurator

Type code

001	Series
PLN	Plastic tubing, polyethylene, standard O.D.
PEN	Plastic tubing
PAN	Standard O.D. tubing
PUN	Plastic tubing, polyurethane

002	Colour
BL	Blue
BR	Brown
GE	Yellow
GN	Green
NT	Natural
RT	Red
SI	Silver
SW	Black
TBL	Translucent blue
TGE	Translucent yellow
TGN	Translucent green
TRT	Translucent red
TSW	Translucent black
WS	White

Datasheet

Operating and environmental conditions

Short type code	PAN-MF, PAN, PAN-R	PEN	PLN	PUN-H, PUN-VO, PUN, PUN-VO-C, PUN-CM
Outside diameter	4 ... 16 mm			3 ... 16 mm
Inside diameter	2.5 ... 12 mm	2.7 ... 10.8 mm	2.9 ... 12 mm	2 ... 11 mm
Temperature-dependent operating pressure	-0.95 ... 35 bar	-0.95 ... 10 bar	-0.95 ... 14 bar	-0.95 ... 30 bar
Operating medium	Compressed air to ISO 8573-1:2010 [7:-:], Mineral oil	Compressed air to ISO 8573-1:2010 [7:-:], Water as per manufacturer's declaration at www.festo.com		Compressed air to ISO 8573-1:2010 [7:-:]
Ambient temperature	-60 ... 100°C	-30 ... 60°C	-30 ... 80°C	-35 ... 60°C
Approval	German Technical Control Board (TÜV)			
Certificate issuing authority	B 013277 0506 00			
Tubing characteristics	–	Suitable for use with energy chains	–	Suitable for use with energy chains

Materials

Short type code	PAN-MF, PAN, PAN-R	PEN	PLN	PUN-H, PUN-VO, PUN, PUN-VO-C, PUN-CM
Material tubing	PA12-P TPE-A	PE		TPE-U(PU)
Shore hardness	–	D 52 +/-3	–	
Note on materials	RoHS-compliant			
LABS (PWIS) conformity	VDMA24364-B1/B2-L			
Cleanroom class	Element installed statically, no meaningful evaluation possible according to ISO 14644-1			

Operating pressure p as a function of temperature t

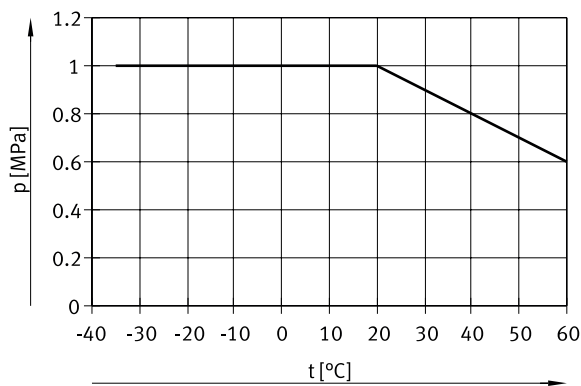

Datasheet

Operating pressure p as a function of temperature t (PUN-H; medium: water)

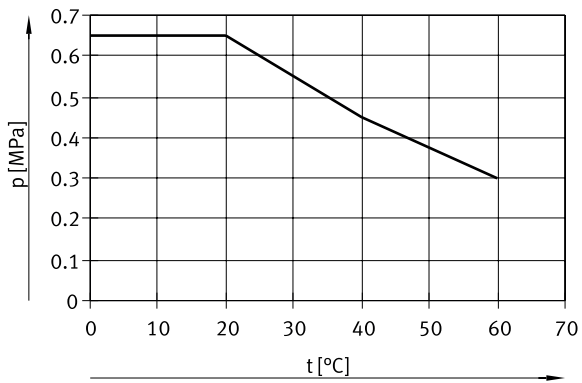

Deviating maximum operating pressures apply to the medium water, with a safety factor of $s=4$.

Operating pressure p as a function of temperature t (PUN)

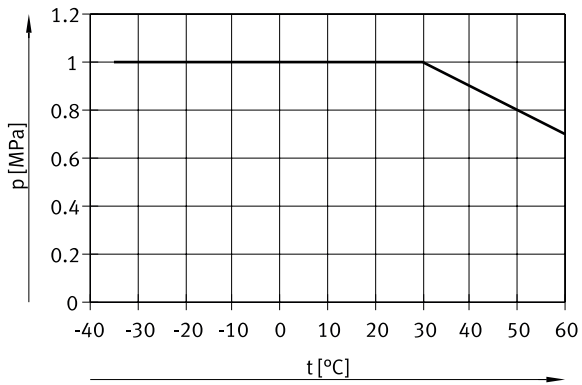

Datasheet

Operating pressure p as a function of temperature t (PUN-CM)

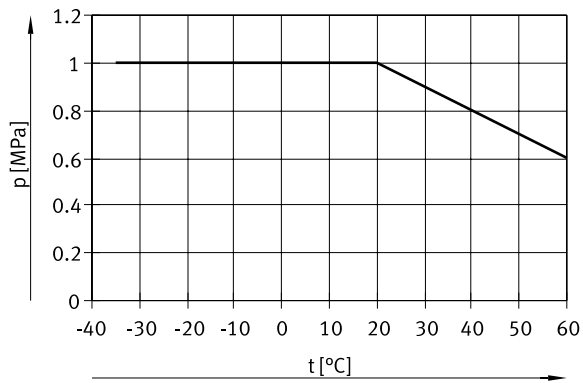

Operating pressure p as a function of temperature t

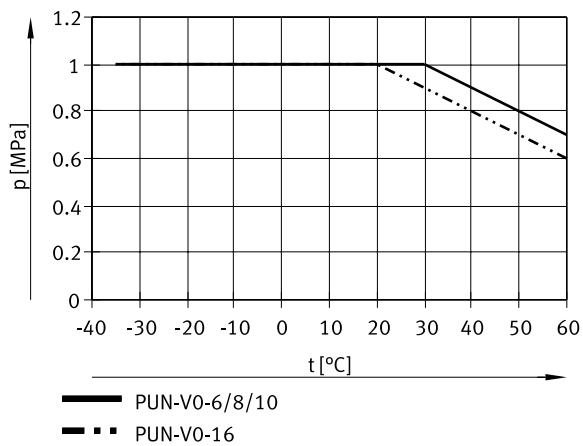

Datasheet

Operating pressure p as a function of temperature t

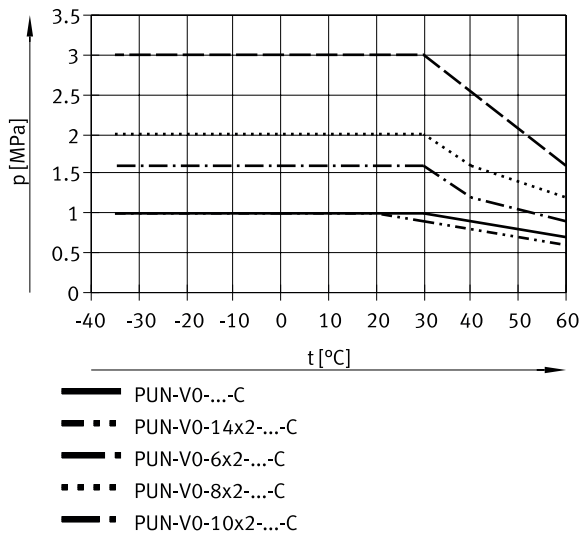

Operating pressure p as a function of temperature t (PAN)

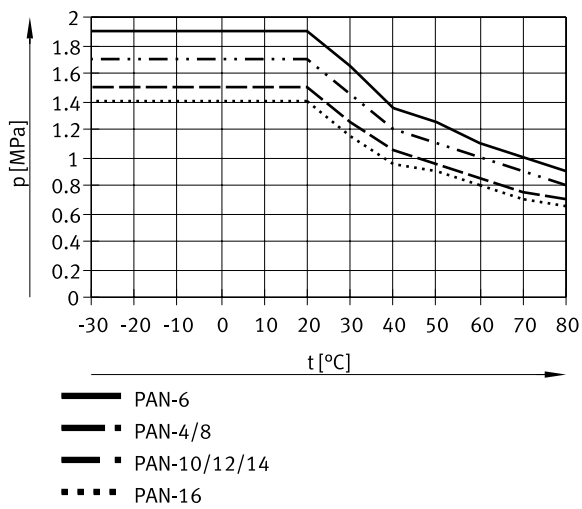

Datasheet

Operating pressure p as a function of temperature t (PAN-MF)

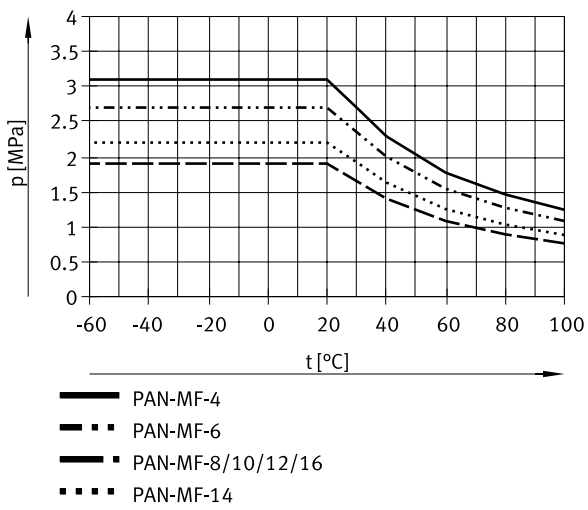

Operating pressure p as a function of temperature t (PAN-R; external \varnothing 4 ... 16 mm)

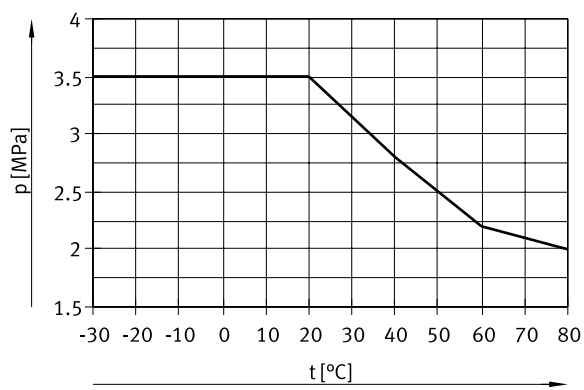

Datasheet

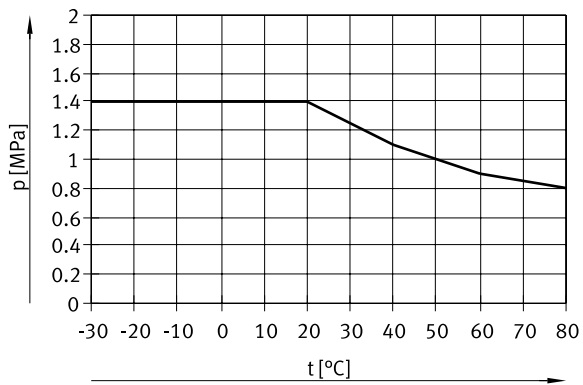
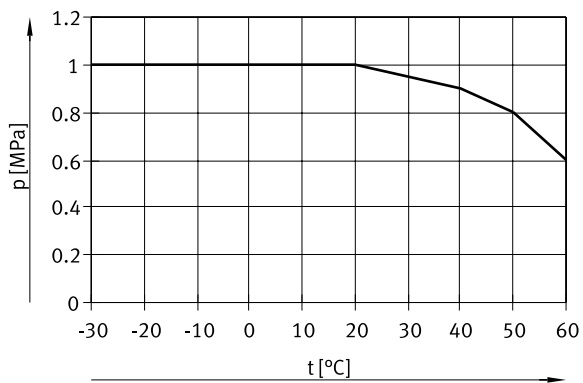
Operating pressure p as a function of temperature t (PAN-R; external \varnothing 22 ... 28 mm)Operating pressure p as a function of temperature t (PEN)

Datasheet

Operating pressure p as a function of temperature t (PLN)

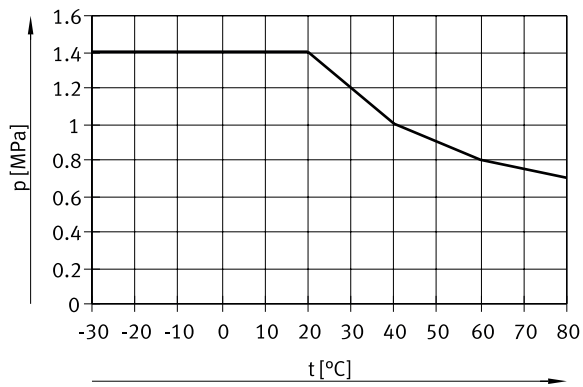

Dimensions

Dimensions – Reel

Download CAD data www.festo.com

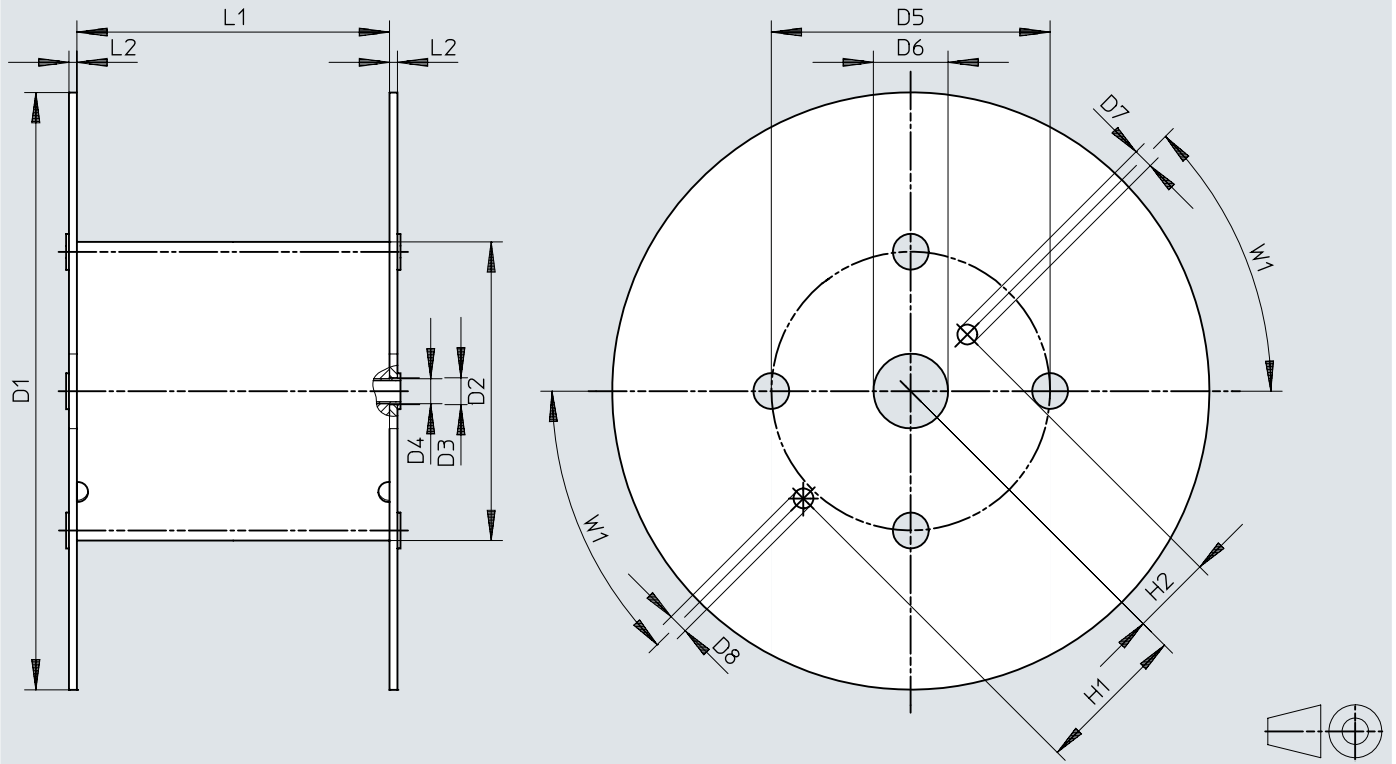

	D1 ∅	D2 ∅	D3 ∅	D4 ∅	D5 ∅	D6 ∅	D7 ∅	D8 ∅	H1	H2	L1	L2	W1									
PAN-4x0,75-...-500	545	246	21	20	216	75	20	20	152,5	80,5	128	8	45°									
PAN-6x1-...-500					280						254											
PAN-8x1,25-...-400		600			310						254											
PAN-10x1,5-...-300																						
PAN-12x1,75-...-200																						
PAN-16x2-...-100	545																					
PAN-MF-4x0,75-...-500	545	246	21	20	216	75	20	20	152,5	80,5	128	8	45°									
PAN-MF-6x1-...-500	600	310			280						114											
PEN-4x0,75-...-500	545	246	21	20	216	75	20	20	152,5	80,5	128	8	45°									
PEN-6x1-...-500					280						254											
PEN-8x1,25-...-400		600			310						254											
PEN-10x1,5-...-300																						
PEN-12x1,75-...-200																						
PEN-16x2,5-...-100	545																					
PUN-3x0,5-...-500	545	246	21	20	216	75	20	20	152,5	80,5	128	8	45°									
PUN-4x0,75-...-500					280						114											
PUN-6x1-...-500		600			310						254											
PUN-8x1,25-...-400																						
PUN-10x1,5-...-300																						
PUN-12x2-...-200	545																					
PUN-H-3x0,5-...-500	545	246	21	20	216	75	20	20	152,5	80,5	128	8	45°									
PUN-H-4x0,75-...-500					280						254											
PUN-H-6x1-...-500		600			310						254											
PUN-H-8x1,25-...-400														280	75	20	20	152,5	80,5	254	8	45°
PUN-H-10x1,5-...-300																						
PUN-H-12x2-...-200	545																					

Ordering data

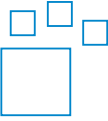
Ordering information – Modular product system			
	Short type code	Part no.	Type
	PAN, PAN-MF, PAN-R	553610	PAN
	PEN	553769	PEN
	PLN	553850	PLN
	PUN, PUN-CM, PUN-H, PUN-V0, PUN-V0-C	553573	PUN