

Ball valve unit KVZB

FESTO

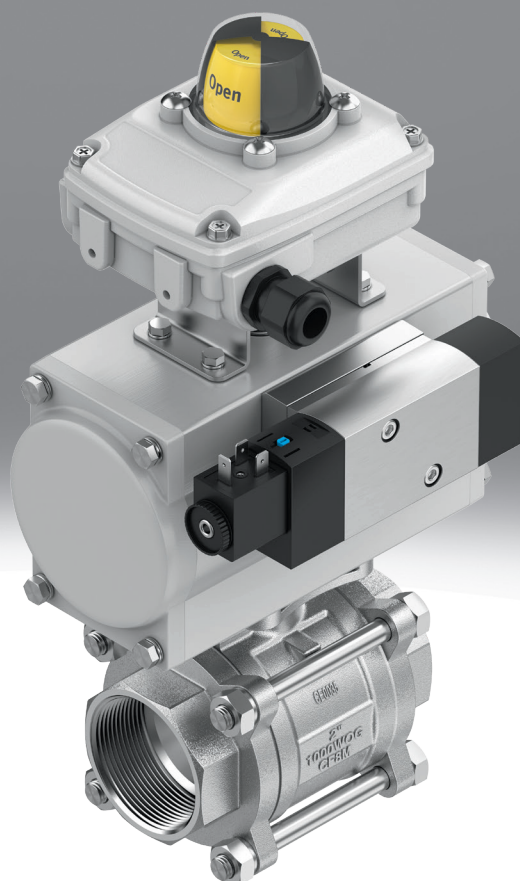

Characteristics

Ordering data - modular system

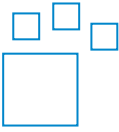
[Link](#) [kvzb](#)

Configurable product

This product and all its product options can be ordered online via the configurator.

Actuation

Automatic

The process valve is actuated using a pneumatic quarter turn actuator.

Manual

The process valve is actuated using a hand lever.

EX certification

II 2GD

ATEX category for gas II 2G

- Type of ignition protection for gas c T6 ... T3 X
- ATEX category for dust II 2D
- Type of ignition protection for dust c T80 °C ... T200 °C X
- Explosion-proof ambient temperature rating $0^{\circ}\text{C} \leq T_a \leq +60^{\circ}\text{C}$

Application

Controlled

The required position of the process valve is specified via an analogue positioning signal, e.g. 4 ... 20 mA.

Open/closed

The process valve is moved into both end positions.

Position indicator

The actual end position of the process valve unit can be transmitted either visually, directly on the process valve or via an electrical signal.

Limit switch box



Optical



Optical and electrical

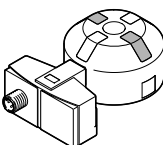

Sensor principle, position indicator

This selection determines the measuring principle for the position indicator. Inductive sensors operate contactlessly. Magnetic reed and changeover switches operate with contacts.

Floating contact, changeover contact

Operating voltage range 0 ... 30 V DC
 Operating voltage range 0 ... 250 V AC
 Max. output current 3000 mA

Inductive

Max. output current 100 mA
 Operating voltage range 5 ... 60 V DC

Characteristics

Magnetic reed

Operating voltage range 0 ... 175 V DC

Max. output current 250 mA

Operating voltage range 0 ... 120 V AC

Pilot valve



The pneumatic pilot valve is mounted directly on the quarter turn actuator via the NAMUR interface.

Standard version

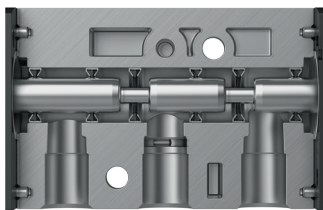

A pneumatic pilot valve, with the design principle of a piston slide, is mounted directly on the quarter turn actuator via the NAMUR interface. The piston slide design is the first choice for all standard applications. The technology enables overlap-free switching and, compared to the poppet valve, has a greater flow rate with the same connection size.

Poppet valve version

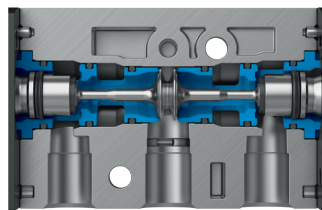

A pneumatic pilot valve, with the design principle of a poppet valve, is mounted directly on the quarter turn actuator via the NAMUR interface. The advantages of the poppet valve design come into their own when the demands on the application increase. They include greater tolerance against "dirty" compressed air, reduced leakages and fewer dynamic seals, which has an impact on service life.

Connection type

Flange

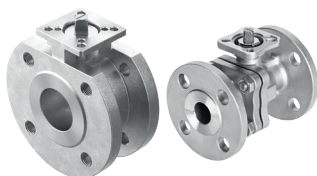

To DIN EN 1092-1 or ANSI B16.5 class 150

Thread

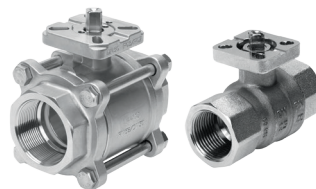

Pipe thread to EN 10226-1 or ASME B1.20.1

Clamp



To DIN 32676-B or ASME-BPE

Welded end

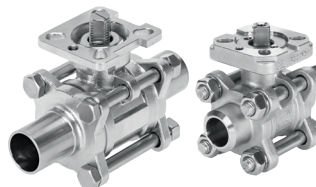

To EN 12627 or with extended welded ends to ISO 1127 or ASME-BPE

Characteristics

Valve function

2/2-way

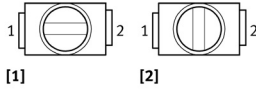

[1] Open

- [2] Closed

3/2-way, L-bore

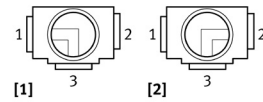

[3] 1 – 3 connected, 2 closed

- [2] 2 – 3 connected, 1 closed

3/2-way, T-bore

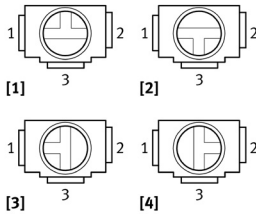

[1] 1 – 2 connected, 3 closed

- [2] 1 – 2 – 3 connected
- [3] 1 – 3 connected, 2 closed
- [4] 2 – 3 connected, 1 closed

Normal position

1-2 connected, 3 closed, T-bore

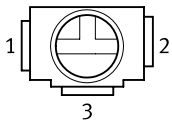

1-2-3 connected, T-bore

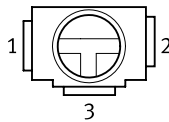

1-3 connected, 2 closed, L-bore

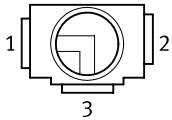

1-3 connected, 2 closed, T-bore

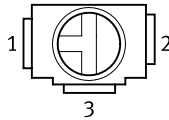

2-3 connected, 1 closed, L-bore

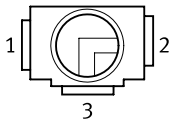

2-3 connected, 1 closed, T-bore

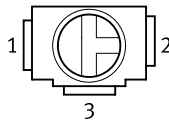

Opened

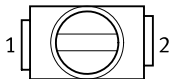

Closed

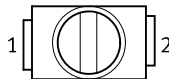

Characteristics

Operating position

1-2 connected, 3 closed, T-bore

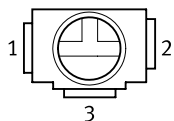

1-2-3 connected, T-bore

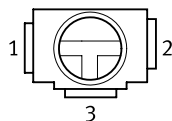

1-3 connected, 2 closed, L-bore

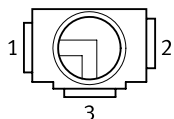

1-3 connected, 2 closed, T-bore

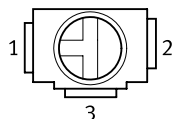

2-3 connected, 1 closed, L-bore

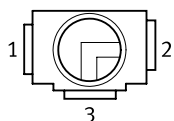

2-3 connected, 1 closed, T-bore

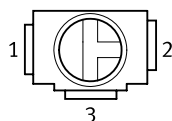

Opened

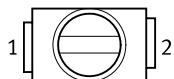

Closed

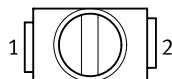

Mode of operation

Double-acting

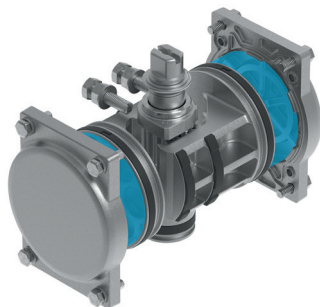

The double-acting quarter turn actuator requires compressed air for each direction of movement. In this mode of operation, the torque for opening or closing the process valve is generated purely via the compressed air.

Single-acting

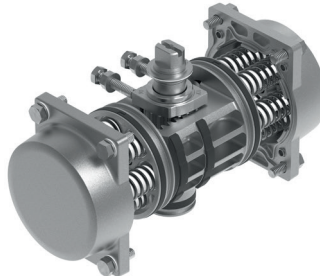

With the single-acting quarter turn actuator, the incoming compressed air moves the pistons in one direction. This generates the torque of the actuator. The springs built into the actuator are pre-tensioned at the same time. This spring force generates the torque in the opposite direction of rotation when the pressure chambers of the actuator are exhausted. This causes the process valve to move to the required initial position.

Safety function

Return to normal position

The valve is moved to the selected normal position if the system fails. Note: The selection of the operating mode (double-acting or single-acting) has a decisive influence on when the safety function is carried out.

“Double-acting” operating mode: this function is carried out by a 5/2-way single solenoid pilot valve. The valve is only moved to the normal position if the operating voltage fails, but not if the compressed air supply fails.

- “Single-acting” operating mode: this function is carried out by a 3/2-way single solenoid pilot valve. If the operating voltage or compressed air supply fails, the valve is moved to the normal position by the spring force of the actuator.

Hold position with 5/3C pilot valve

The valve is held in the current position if the operating voltage supply or compressed air fails. This function is only possible with the “double-acting” operating mode and is carried out by a 5/3-way pilot valve with closed intermediate position.

Characteristics

Hold position with 5/2B pilot valve

The valve is held in the current position if the operating voltage supply fails. This function is only possible with the “double-acting” operation mode and is carried out by a 5/2-way double solenoid pilot valve which remains in the position last occupied before the fault occurred when pressure is applied to one side of the actuator. If the compressed air supply fails, the valve cannot be guaranteed to remain in the current position.

Operating pressure

The operating pressure available for actuating the quarter turn actuator.

Safety factor

The specification of a safety factor is recommended when configuring a quarter turn actuator because this increases the available torque reserve.
Pipeline medium liquid 1.2

- Pipeline medium sticky/viscous 1.6
- Pipeline medium gaseous 1.5

These values are reference values and must be reviewed according to the application.

Closing torque factor

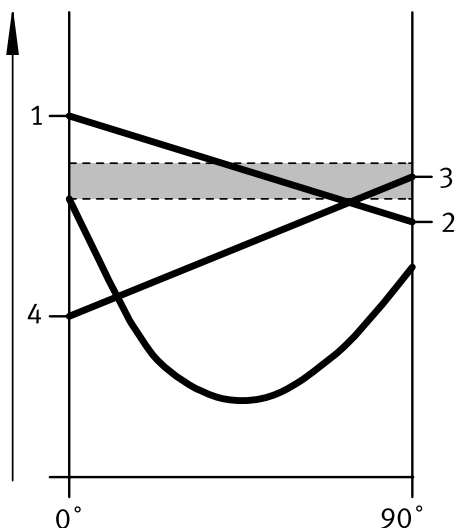

1 → 2 connection pressure

3 → 4 spring force

0° = ball valve closed, 90° = ball valve open

Note: Specification of the closing torque factor is optional.

The torque required to operate the process valve is greatest at the start of the movement (breakaway torque). Under certain conditions, the closing torque of the process valve can be smaller than the breakaway torque. If this difference is known, it can be taken into account by specifying a closing torque factor.

For single-acting actuators, the correct sizing between the supply pressure (1 → 2) and the spring force (3 → 4) must be taken into account. When the ball valve opens, the actuator works against the spring and increases the spring force, while the supply pressure decreases at the same time. Point [1] in the diagram is the breakaway torque required to release the ball valve. Point [4] is the closing torque needed to return the ball valve to the closed position.

High corrosion resistance

Yes

Higher corrosion resistance thanks to epoxy coating of the pneumatic quarter turn actuator. The actuator shaft is stainless steel.

Datasheet

General technical data

Design	–
Mode of operation	–
Size of valve actuator	–
Flange hole pattern	–
Swivel angle	–
Product weight	1 ... 120 kg

Operating and environmental conditions

Ambient temperature	–
Operating pressure	–
Operating pressure	–
Operating pressure	–
LABS (PWIS) conformity	VDMA24364 zone III
Note on materials	RoHS-compliant

ATEX VSNC

Short type code	VSNC
ATEX category gas	II 2G
Explosion ignition protection type for gas	Ex ia IIC T6 Ga
ATEX category dust	II 2D
Explosion ignition protection type for dust	Ex t IIIC T80°C Db
Explosion ambient temperature	-40°C ≤ Ta ≤ +50°C

ATEX SRBC

Short type code	SRBC
ATEX category gas	II 1G
Explosion ignition protection type for gas	Ex ia IIC T6...T1 Ga
ATEX category dust	II 1D
Explosion ignition protection type for dust	Ex i IIIC Txx°C Da
Explosion ambient temperature	See ATEX certificate, See IECEx certificate

ATEX SRBG

Short type code	SRBG
ATEX category gas	II 1G
Explosion ignition protection type for gas	Ex ia IIC T6...T1 Ga
ATEX category dust	II 1D
Explosion ignition protection type for dust	Ex ia IIIC T200 135°C Da
Explosion ambient temperature	See ATEX certificate, See IECEx certificate

Ordering data

Ordering information – Modular product system			
	Description	Part no.	Type
	Automatically actuated with semi-rotary drive, Controlled operation with quarter turn actuator and valve positioner, Manually actuated with hand lever, Variants to EU Explosion Protection Directive (ATEX)	8102172	KVZB-

Peripherals

Peripherals overview

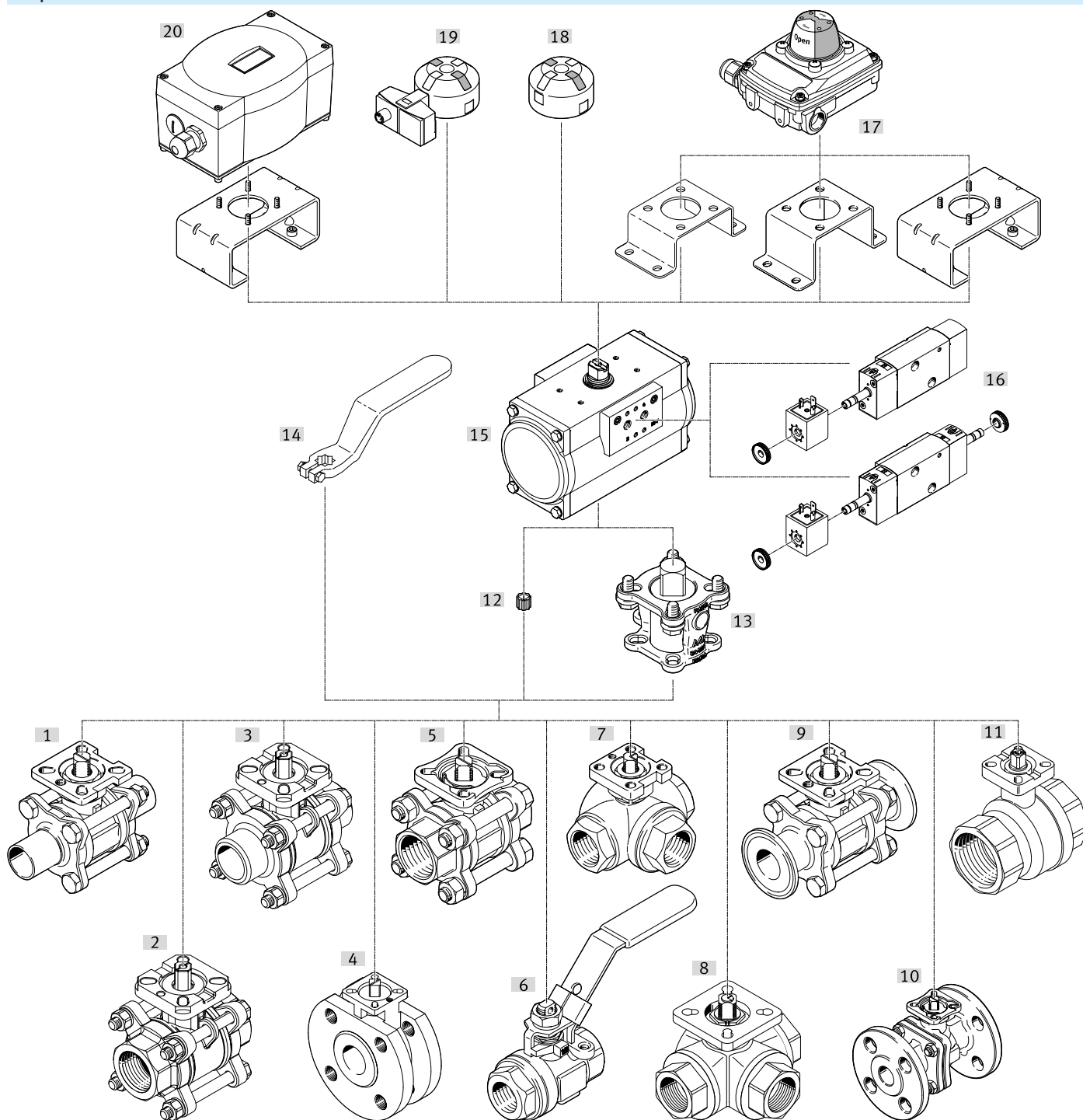

Accessories			→ Link
Type/order code	Description		
[1] Ball valves 2-way VZBD	- Extended welded ends according to ISO 1127 - Extended welded ends according to ASME-BPE		vzbd
[2] Ball valves 2-way VZBA-...-GG	- Pipe thread according to EN 10226-1 - Stainless steel design		vzba
[3] Ball valves 2-way VZBA-...-WW	- Welding ends according to EN 12627 - Stainless steel design		vzba
[4] Ball valves 2-way VZBC	- Compact design with flange according to DIN EN 1092-1 - Stainless steel design		vzbc
[5] Ball valves 2-way VZBE	- Pipe thread according to ASME B1.20.1 - Stainless steel design		vzbe

Peripherals

Accessories		→ Link
Type/order code	Description	
[6] Ball valves 2-way VZBE	- Pipe thread according to ASME B1.20.1 - Actuated via hand lever - Stainless steel design	vzbe
[7] Ball valves 3-way VZBE	- Pipe thread according to ASME B1.20.1 - With L-bore or T-bore - Stainless steel design	vzbe
[8] Ball valves 3-way VZBA	- Pipe thread according to EN 10226-1 - With L-bore or T-bore - Stainless steel design	vzba
[9] Ball valves 2-way VZBD	- Clamp ferrule according to DIN 32676-B or ASME-BPE - Stainless steel design	vzbd
[10] Ball valves 2-way VZBF	- Flange according to ANSI B16.5 Class 150 - Stainless steel design	vzbf
[11] Ball valves 2-way VAPB	- Pipe thread according to EN 10226-1 - Brass design	vapb
[12] Reducing sleeves DARQ-R...	For square adjustment of the ball valves	darq
[13] Mounting kits DARQ-KV-...	For connecting quarter turn actuators and ball valves	darq
[14] Hand lever VAOH	Manual operation of the ball valves, lockable manual operation of the ball valves, lockable	vaoh
[15] Quarter turn actuators DFPD	In single-acting or double-acting design, has a gear rack-and-pinion combination with a constant torque curve over the entire swivel range, port pattern according to VDI/VDE 3845	dfpd
[16] Solenoid valves VSNC	Pilot valves with solenoid coils VACF for single-acting and double-acting quarter turn actuators with port pattern according to VDI/VDE 3845, can be converted from 3/2 to 5/2 directional control valve simply by turning the seal	vsnc
[17] Sensor boxes SRBC	For electrical feedback and control of the position of process valves, with mounting adapter, sturdy and corrosion-resistant design, highly visible 3D position indicator for quickly detecting the current position of the quarter turn actuator	srbc
[18] Position indicators SASF	The compact solution, the direct mounting really minimises the space requirement, with four fixed actuating vanes offset by 90°	sASF
[19] Sensor boxes SRBG	For electrical feedback and checking the position of process valves, is mounted without additional accessories on quarter turn actuators with port pattern according to VDI/VDE 3845, with M12 plug or terminal strip	srbg
[20] Positioner CMSX	Based on the PID control algorithm, used for position control of single-acting and double-acting pneumatic quarter turn actuators with mechanical interface according to VDI/VDE 3845	cmsx