

## Round cylinder DSNU-S

**FESTO**



## Characteristics

### At a glance

Further information → [dsnu-s](#)

- Space-optimised, ideal for narrow installation spaces
- Piston rod with male and female threads
- Quick and easy to install.
- Lightweight
- Stainless steel cylinder barrel
- End cap made of wrought aluminium alloy

### Product segmentation



Festo Core Range

Solves the majority of your automation tasks

With the Festo Core Range, we have selected the most important products and functions from our broad product catalogue, and added the quickest delivery. the Core Range offers you the best value with the expected high Festo quality.

- Quickest delivery, worldwide – wherever, whenever
- Expected high Festo quality
- Easy and fast to select

### Ordering data - modular system

Further information → [dsnu-s](#)

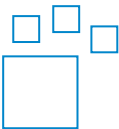

Configurable product

This product and all its product options can be ordered online via the configurator.

### Diagrams

Further information → [dsnu-s](#)



The diagrams shown in this document are also available online. These can be used to display precise values.

### Product version

[S] Space-saving

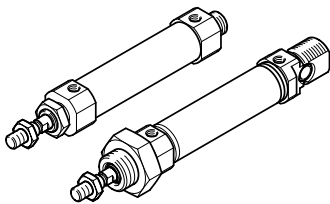

DSNU-S compared to DSNU:

- Total width reduced by up to 40%
- Total length up to 3.5 cm shorter

## Characteristics

### Cushioning

End-position cushioning has the following functions:

- Reduces kinetic energy in the end positions
- Avoids vibrations
- Reduces noise generation

[P] Elastic cushioning rings/plates on both sides

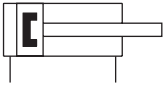

The drive is fitted with elastic polymer end-position cushioning.

Benefits:

- No adjustment required
- Saves time

[PPS] Pneumatic cushioning, self-adjusting at both ends



The drive is fitted with pneumatic end-position cushioning, which automatically adapts to the moving mass and speed and does not need to be adjusted by the operator.

Benefits:

- Saves time
- Powerful

### Position sensing

[A] For proximity sensor

By using proximity switches, any position can be detected.

### Special material properties

[F1A] Recommended for production facilities for the manufacture of lithium-ion batteries

Product:

- Metals with more than 1% copper, zinc or nickel by mass are excluded from use. Exceptions are nickel in steel, chemically nickel-plated surfaces, circuit boards, cables, electrical plug connectors and coils

Accessories:

- Please contact your Festo representative for information on which accessories are suitable for manufacturing lithium-ion batteries

### Cylinder end cap

[MX] Mounting thread, end cap



- Short end cap with mounting thread
- Stainless steel cylinder barrel
- Bearing cap with threaded flange

[MQ] Transverse supply port, end cap



- Short end cap with compressed air supply port, transverse
- Stainless steel cylinder barrel
- Bearing cap with threaded flange

[MP] Swivel mounting, end cap



- Short end cap with swivel mounting
- Stainless steel cylinder barrel
- Bearing cap with threaded flange

[MA] Axial air connection, end cap



- Short end cap with compressed air supply port, axial
- Stainless steel cylinder barrel
- Bearing cap with threaded flange

## Characteristics

### Piston rod thread extension

[K2] 1 ... 35 mm



The male piston rod thread can be extended:

- Ø 8: 1 ... 15 mm
- Ø 12, 16: 1 ... 20 mm
- Ø 20: 1 ... 25 mm
- Ø 25: 1 ... 35 mm

### K6 - Shortened male piston rod thread

[K6] 1 ... 8 mm



The male piston rod thread can be shortened:

- Ø 8, 12, 16: 1 ... 4 mm
- Ø 20, 25: 1 .. 8 mm

### Piston rod thread type

[ ] Male thread



[K3] With female thread



### Piston rod extension

[...K8] 1 ... 150 mm



The piston rod can be extended at one end:

- Ø 8: 1 ... 50 mm
- Ø 12, 16: 1 ... 100 mm
- Ø 20: 1 ... 110 mm
- Ø 25: 1 ... 150 mm

## Type code

001	Series	
DSNU	Round cylinder, double-acting, based on ISO 6432	
002	Design type	
S	Short	
003	Piston diameter [mm]	
8	8	
12	12	
16	16	
20	20	
25	25	
004	Stroke [mm]	
...	1 ... 200	
005	Cushioning	
PPS	Pneumatic cushioning, self-adjusting at both ends	
P	Elastic cushioning rings/plates on both sides	
006	Position sensing	
A	For proximity sensor	

007	Special material properties	
F1A	Recommended for production facilities for the manufacture of lithium-ion batteries	
008	Cylinder end cap	
MA	Axial air connection, end cap	
MQ	Transverse supply port, end cap	
MX	Mounting thread, end cap	
MP	Swivel mounting, end cap	
009	Piston rod thread extension	
	None	
K2	1 ... 35 mm	
010	Piston rod thread type	
	Male thread	
K3	With female thread	
011	K6 - Shortened male piston rod thread	
	None	
K6	1 ... 8 mm	
012	Piston rod extension	
	None	
...K8	1 ... 150 mm	

## Datasheet

### General technical data

Piston diameter	8 mm	12 mm	16 mm	20 mm	25 mm
Stroke <sup>1)</sup>	10 mm, 15 mm, 20 mm, 25 mm, 30 mm, 40 mm, 50 mm, 60 mm, 80 mm, 100 mm	10 mm, 15 mm, 20 mm, 25 mm, 30 mm, 40 mm, 50 mm, 60 mm, 80 mm, 100 mm, 125 mm, 150 mm	10 mm, 15 mm, 20 mm, 25 mm, 30 mm, 40 mm, 50 mm, 60 mm, 80 mm, 100 mm, 125 mm, 150 mm, 200 mm		
Pneumatic connection	M5			G1/8	
Piston rod thread <sup>2)</sup>	M4	M6	M8	M10x1.25	
Design	Piston Piston rod Cylinder barrel				
Mode of operation	Double-acting				
Cushioning	Elastic cushioning rings/plates at both ends		Elastic cushioning rings/plates at both ends Self-adjusting pneumatic end-position cushioning		
Cushioning length	–		12 mm	15 mm	17 mm
Position detection	Via proximity switch				
Type of mounting	With accessories				
Mounting position	optional				

1) Cylinders with position sensing require a minimum stroke of 10 mm to ensure reliable sensing. Also available with longer strokes on request.

2) Male thread / female thread: Ø 8: M4 / M2.5 Ø 12: M6 / M3 Ø 16: M6 / M3 Ø 20: M8 / M4 Ø 25: M10x1.25 / M6

### Operating and environmental conditions

Piston diameter	8 mm	12 mm	16 mm	20 mm	25 mm
Operating medium	Compressed air to ISO 8573-1:2010 [7:4:4]				
Note on operating and pilot medium	Lubricated operation possible (in which case lubricated operation will always be required)				
Operating pressure	0.15 ... 1 MPa		0.08 ... 1 MPa		0.06 ... 1 MPa
Operating pressure	1.5 ... 10 bar		0.8 ... 10 bar		0.6 ... 10 bar
Operating pressure	21.75 ... 145 psi		11.6 ... 145 psi		8.7 ... 145 psi
Ambient temperature <sup>1)</sup>	-20 ... 80°C				
Corrosion resistance class CRC <sup>2)</sup>	0 - No corrosion stress 2 - Moderate corrosion stress				

1) Note operating range of the proximity switches.

2) DSNU-S-...: KBK2

DSNU-S-...-F1A: KBK0

More information [www.festo.com/x/topic/crc](http://www.festo.com/x/topic/crc)

### Weight

Piston diameter	8 mm	12 mm	16 mm	20 mm	25 mm
Basic weight for 0 mm stroke	20 g	35.9 g	48.9 g	126 g	180.2 g
Additional weight per 10 mm stroke	2.4 g	4.2 g	4.8 g	7.2 g	11 g
Moving mass for 0 mm stroke	6.3 g	16.2 g	18.3 g	37.3 g	63.6 g
Additional moving mass per 10 mm stroke	1 g	2 g		4 g	6 g

### Forces and impact energy

Piston diameter	8 mm	12 mm	16 mm	20 mm	25 mm
Theoretical force at 0.6 MPa (6 bar, 87 psi), advance stroke	30.2 N	67.9 N	120.6 N	188.5 N	294.5 N
Theoretical force at 0.6 MPa (6 bar, 87 psi), return stroke	22.6 N	50.9 N	103.7 N	158.3 N	247.4 N

## Datasheet

### Materials

Material cover	Anodised wrought aluminium alloy
Material piston rod	High-alloy stainless steel
Material cylinder barrel	High-alloy stainless steel
Material seals	TPE-U(PU)
Note on materials	RoHS-compliant
LABS (PWS) conformity	VDMA24364-B2-L
Cleanroom class	Class 6 according to ISO 14644-1
Suitability for the production of Li-ion batteries	Metals with more than 1% by mass of copper, zinc or nickel are excluded from use. Exceptions are nickel in steel, chemically nickel-plated surfaces, printed circuit boards, cables, electrical plug connectors and coils

### Max. transverse force $F_q$ as a function of projection $l$

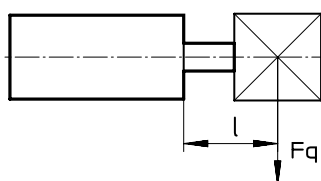

### Max. transverse force $F_q$ as a function of projection $l$ – DSNU-S-8

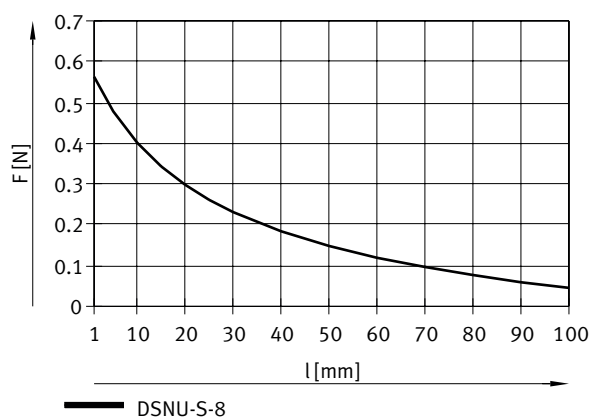

### Max. transverse force $F_q$ as a function of projection $l$ – DSNU-S-12 ... 20

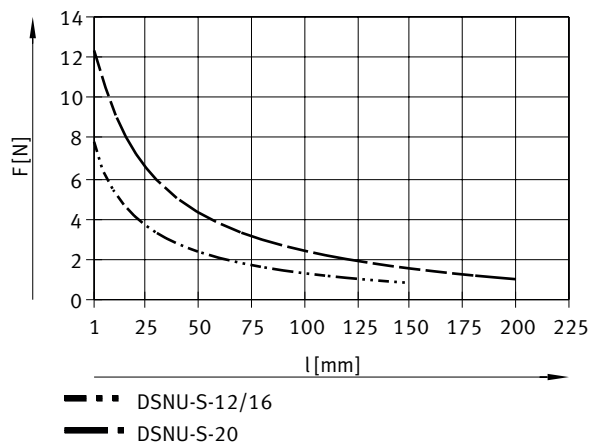

## Datasheet

### Max. transverse force $F_q$ as a function of projection $l$ – DSNU-S-25

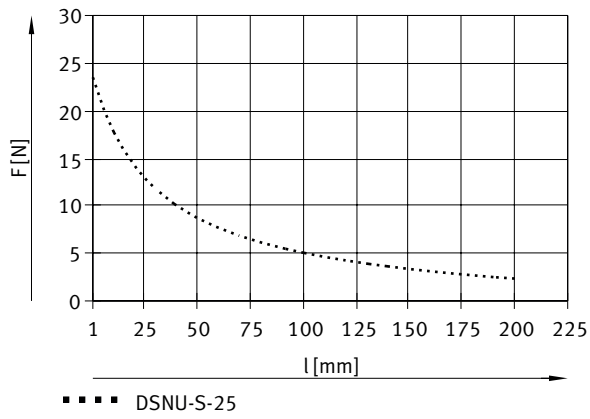



## Dimensions

Dimensions – DSNU-S-...-MX – Mounting thread, short end cap

Download CAD data → [www.festo.com](http://www.festo.com)

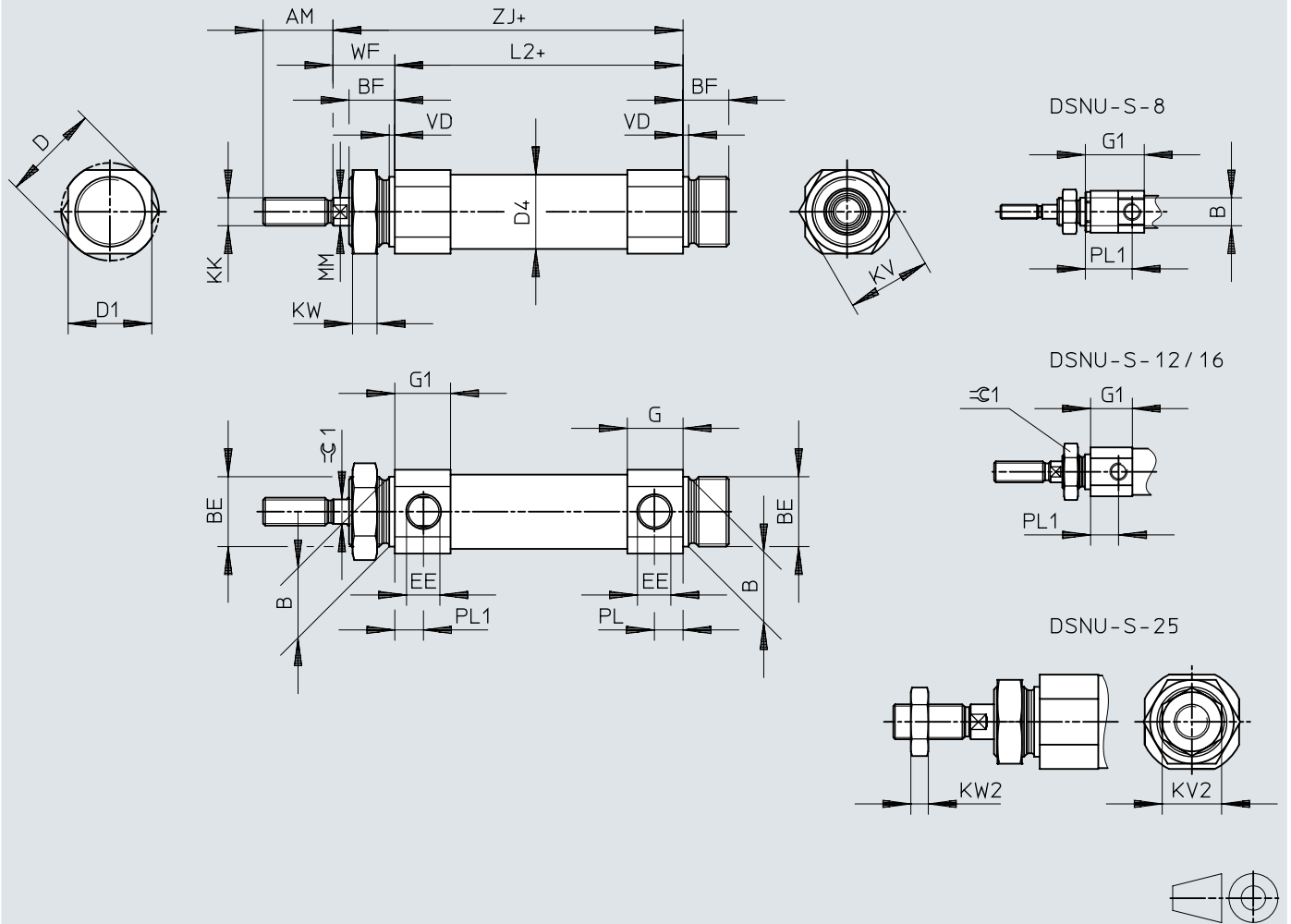

[1] += plus stroke length

Dimensions

	AM	B h8	BE	BF	D ∅	D1 ∅	D4 ∅	EE	G		G1
									[-P]	[-PPS]	
DSNU-S-8-...-MX	12	8	M8x1	8	14	12	9,3	M5	9	-	16,9
DSNU-S-12-...-MX	16	10	M10x1		16	14	13,3		9,7		12
DSNU-S-16-...-MX					20	18	17,3		11,2	9,7	11,2
DSNU-S-20-...-MX	20	20	M20x1,5	13	28	24	21,3	G1/8	16	-	16
DSNU-S-25-...-MX	22				30	27	26,5		16,8		16,8

	KK	KV	KV2	KW	KW2	L2		MM ∅	PL	PL1	VD
						[-P]	[-PPS]				
DSNU-S-8-...-MX	M4	11	-	4	-	45,6	-	4	5	13,4	1,5
DSNU-S-12-...-MX	M6	14				46,1		6	6	8	
DSNU-S-16-...-MX						45,7	57,2	7,5			
DSNU-S-20-...-MX	M8	24	17	7	5	57,8	-	8	8,2	-	
DSNU-S-25-...-MX	M10x1,25					60,8	10	8,3	-		

	WF	Z)		≈G1
		[-P]	[-PPS]	
DSNU-S-8-...-MX	11,9 ±0,7	57,5 ±1	-	-
DSNU-S-12-...-MX	13 ±0,7	59,1 ±1		5
DSNU-S-16-...-MX	12,9 ±0,75	58,6 ±1	70,1 ±0,1	7
DSNU-S-20-...-MX	17,3 ±0,75	75,1 ±1	-	9
DSNU-S-25-...-MX	19,6 ±0,75	80,4 ±1		

## Dimensions

Dimensions – DSNU-S-...-MP – Swivel mounting, short end cap

Download CAD data → [www.festo.com](http://www.festo.com)

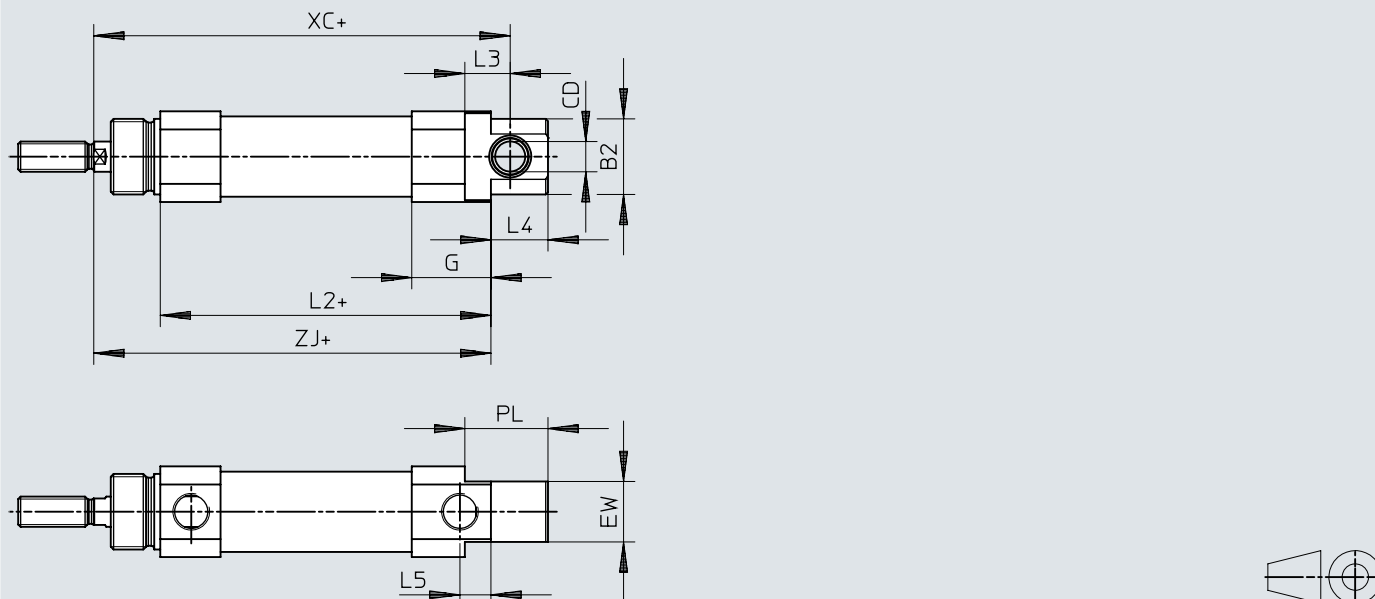

[1] += plus stroke length

	B2 ø	CD ø	EW	G		L2	
				[-P]	[-PPS]	[-P]	[-PPS]
DSNU-S-8-...-MP	10	4	8	9	-	45,6	-
DSNU-S-12-...-MP				9,7		46,1	
DSNU-S-16-...-MP	14,5	6	12	11,2	9,7	45,7	57,2
DSNU-S-20-...-MP	20	8	16	21	-	62,8	-
DSNU-S-25-...-MP				21,8		65,8	

	L3	L4	L5	PL	XC		ZJ	
					[-P]	[-PPS]	[-P]	[-PPS]
DSNU-S-8-...-MP	6,3	8	11,5	5	60,3	-	57,5 ±1	-
DSNU-S-12-...-MP		11	12,5	6	63,9		59,1 ±1	
DSNU-S-16-...-MP	9	10	16,5		8,2	61,1	72,6	58,6 ±1
DSNU-S-20-...-MP	12	15,1	22	8,3	85,2	-	80,1 ±1	-
DSNU-S-25-...-MP		16,1		91,5	85,4 ±1			

## Dimensions

Dimensions – DSNU-S-...-MQ – Lateral supply port, short end cap

Download CAD data → [www.festo.com](http://www.festo.com)

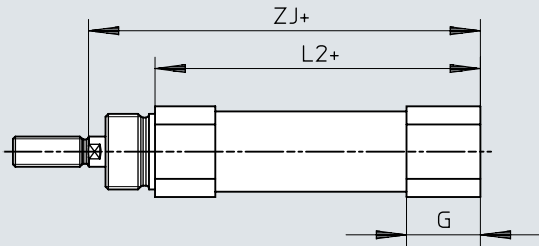

[1] + = plus stroke length

	G		L2		ZJ	
	[-P]	[-PPS]	[-P]	[-PPS]	[-P]	[-PPS]
DSNU-S-8-...-MQ	9	-	45,6	-	57,5 ±1	-
DSNU-S-12-...-MQ	9,7		46,1		59,1 ±1	
DSNU-S-16-...-MQ	11,2	9,7	45,7	57,2	58,6 ±1	70,1 ±0,1
DSNU-S-20-...-MQ	19,6	-	61,4	-	78,7 ±1	-
DSNU-S-25-...-MQ	22,4		66,4		88 ±1	

## Dimensions

Dimensions – DSNU-S-...-MA – Axial supply port, short end cap

Download CAD data → [www.festo.com](http://www.festo.com)

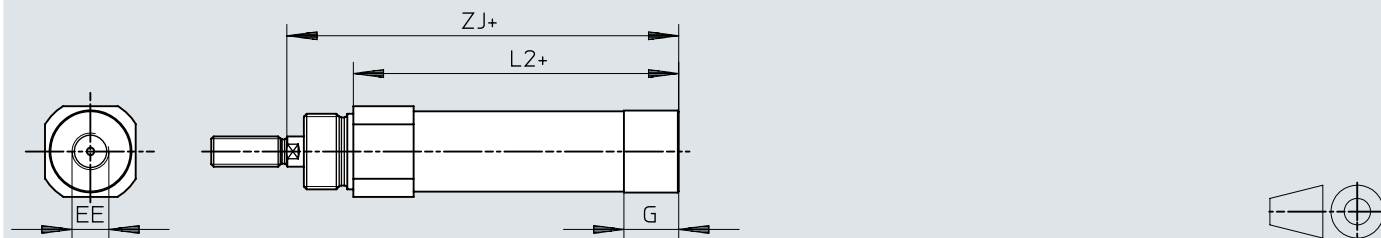

[1] += plus stroke length

	EE	G	L2	ZJ ±1
DSNU-S-8-...-MA	M5	7,6	47,7	59,6
DSNU-S-12-...-MA		7,7	47,2	60,2
DSNU-S-16-...-MA			48,7	61,6
DSNU-S-20-...-MA	G1/8	14,5	61,4	78,7
DSNU-S-25-...-MA		14	63,4	83

## Dimensions

Dimensions – DSNU-S-...-K2 – Extended male piston rod thread

Download CAD data → [www.festo.com](http://www.festo.com)

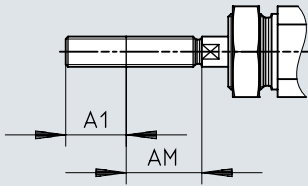

[1] += plus stroke length

	A1 max.	AM
DSNU-S-8-...-K2	15	12
DSNU-S-12-...-K2	20	16
DSNU-S-16-...-K2		
DSNU-S-20-...-K2	25	20
DSNU-S-25-...-K2	35	22

## Dimensions

### Dimensions – DSNU-S-...-K6 – Shortened male piston rod thread

Download CAD data → [www.festo.com](http://www.festo.com)

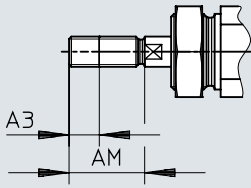

[1] + = plus stroke length

	A3	AM
	max.	
DSNU-S-8-...-K6		12
DSNU-S-12-...-K6	4	16
DSNU-S-16-...-K6		20
DSNU-S-20-...-K6	8	22
DSNU-S-25-...-K6		

## Dimensions

Dimensions – DSNU-S-...-K3 – Female thread on the piston rod

Download CAD data → [www.festo.com](http://www.festo.com)

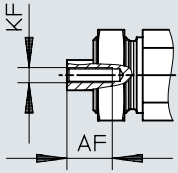

[1] + = plus stroke length

	AF	KF
DSNU-S-8-...-K3	5	M2,5
DSNU-S-12-...-K3	6	M3
DSNU-S-16-...-K3		M4
DSNU-S-20-...-K3	12	M6
DSNU-S-25-...-K3		



## Dimensions

## Dimensions – DSNU-S-...-K8 – Extended piston rod

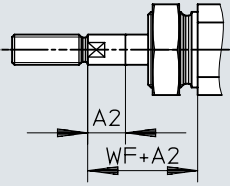
Download CAD data → [www.festo.com](http://www.festo.com)

[1] += plus stroke length

	A2	WF
	max.	
DSNU-S-8-...-K8	50	11,9 ±0,7
DSNU-S-12-...-K8	100	13 ±0,7
DSNU-S-16-...-K8		12,9 ±0,75
DSNU-S-20-...-K8	110	17,3 ±0,75
DSNU-S-25-...-K8	150	19,6 ±0,75

## Dimensions

### Dimensions – Foot mounting HBN-S

Download CAD data → [www.festo.com](http://www.festo.com)

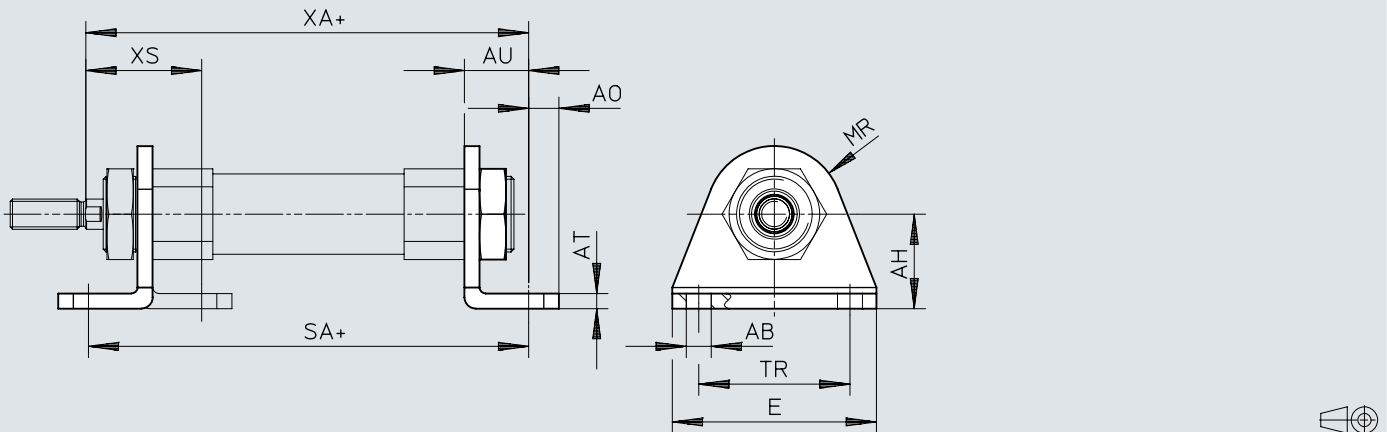

[1] + = plus stroke length

	AB ∅	AH	AO	AT	AU ±0,2	E	MR	SA		TR ±0,1	XA		XS
									DSNU-PPS			DSNU-PPS	
HBN-S-8	4,5	10	5	2	11	35	7	67,4	–	25	68,7	–	21,3
HBN-S-12	5,5	15	6	3	14	42	10	74	–	32	73,3	–	24,3
HBN-S-16	5,5	15	6	3	14	42	10	73,5	85	32	72,8	84,3	24,3
HBN-S-20	6,6	25	8	4	17	54	18	91,6	91,6	40	92,3	92,3	30,7
HBN-S-25	6,6	25	8	4	17	54	18	94,3	94,3	40	97,3	97,3	33

## Dimensions

## Dimensions – Clevis foot LBN

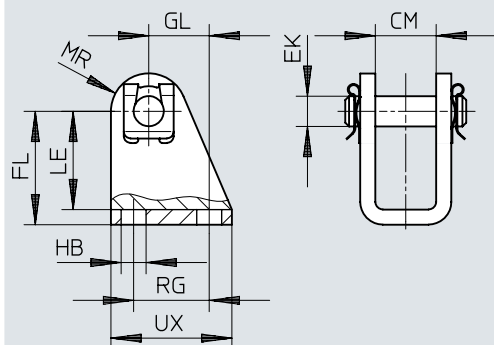
Download CAD data → [www.festo.com](http://www.festo.com)

	CM	EK ∅	FL	GL	HB	LE	MR	RG	UX
LBN-8/10 <sup>1)</sup>	8,1	4	24 +0,3/-0,2	13,8	4,5	21,5	5	12,5	20
LBN-12/16 <sup>1)</sup>	12,1	6	27 +0,3/-0,2	13	5,5	24	7	15	25
LBN-20/25 <sup>1)</sup>	16,1	8	30 +0,4/-0,2	16	6,6	26	10	20	32

1) You can find out which accessory fits which piston ∅ of the product in the chapter on Accessories.

Ordering data

DSNU-S-8 ... 16 with P cushioning					
	Piston diameter	Stroke	Cylinder end cap	Part no.	Type
	8 mm	10 mm	Transverse supply port, end cap	5205897	DSNU-S-8-10-P-A-MQ
		15 mm		5205898	DSNU-S-8-15-P-A-MQ
		20 mm		5205899	DSNU-S-8-20-P-A-MQ
		25 mm		5205900	DSNU-S-8-25-P-A-MQ
		30 mm		5205902	DSNU-S-8-30-P-A-MQ
		40 mm		5205903	DSNU-S-8-40-P-A-MQ
		50 mm		5205904	DSNU-S-8-50-P-A-MQ
		60 mm		5205905	DSNU-S-8-60-P-A-MQ
		80 mm		5205906	DSNU-S-8-80-P-A-MQ
		100 mm		5205907	DSNU-S-8-100-P-A-MQ
	12 mm	10 mm	★ 5211896	DSNU-S-12-10-P-A-MQ	
		15 mm	★ 5211897	DSNU-S-12-15-P-A-MQ	
		20 mm	★ 5211898	DSNU-S-12-20-P-A-MQ	
		25 mm	★ 5211899	DSNU-S-12-25-P-A-MQ	
		30 mm	★ 5211900	DSNU-S-12-30-P-A-MQ	
		40 mm	★ 5211901	DSNU-S-12-40-P-A-MQ	
		50 mm	★ 5211903	DSNU-S-12-50-P-A-MQ	
		60 mm	★ 5211904	DSNU-S-12-60-P-A-MQ	
		80 mm	★ 5211905	DSNU-S-12-80-P-A-MQ	
		100 mm	★ 5211906	DSNU-S-12-100-P-A-MQ	
		125 mm	★ 5211908	DSNU-S-12-125-P-A-MQ	
		150 mm	★ 5211909	DSNU-S-12-150-P-A-MQ	
		16 mm	10 mm	★ 5216087	DSNU-S-16-10-P-A-MQ
			15 mm	★ 5216088	DSNU-S-16-15-P-A-MQ
			20 mm	★ 5216089	DSNU-S-16-20-P-A-MQ
	25 mm		★ 5216090	DSNU-S-16-25-P-A-MQ	
	30 mm		★ 5216091	DSNU-S-16-30-P-A-MQ	
	40 mm		★ 5216093	DSNU-S-16-40-P-A-MQ	
	50 mm		★ 5216094	DSNU-S-16-50-P-A-MQ	
	60 mm		★ 5216095	DSNU-S-16-60-P-A-MQ	
	80 mm		★ 5216096	DSNU-S-16-80-P-A-MQ	
	100 mm		★ 5216098	DSNU-S-16-100-P-A-MQ	
	125 mm		★ 5216099	DSNU-S-16-125-P-A-MQ	
	150 mm		★ 5216100	DSNU-S-16-150-P-A-MQ	
	200 mm		★ 5216101	DSNU-S-16-200-P-A-MQ	

DSNU-S-20 ... 25 with P cushioning						
	Piston diameter	Stroke	Cylinder end cap	Part no.	Type	
	20 mm	10 mm	Mounting thread, end cap	★ 5224633	DSNU-S-20-10-P-A-MX	
		15 mm		★ 5224634	DSNU-S-20-15-P-A-MX	
		20 mm		★ 5224635	DSNU-S-20-20-P-A-MX	
		25 mm		★ 5224636	DSNU-S-20-25-P-A-MX	
		30 mm		★ 5224637	DSNU-S-20-30-P-A-MX	
		40 mm		★ 5224639	DSNU-S-20-40-P-A-MX	
		50 mm		★ 5224641	DSNU-S-20-50-P-A-MX	
		60 mm		★ 5224642	DSNU-S-20-60-P-A-MX	
		80 mm		★ 5224643	DSNU-S-20-80-P-A-MX	
		100 mm		★ 5224644	DSNU-S-20-100-P-A-MX	
		125 mm		★ 5224645	DSNU-S-20-125-P-A-MX	
		150 mm		★ 5224646	DSNU-S-20-150-P-A-MX	
		200 mm		★ 5224647	DSNU-S-20-200-P-A-MX	
		25 mm		10 mm	★ 5228227	DSNU-S-25-10-P-A-MX
				15 mm	★ 5228228	DSNU-S-25-15-P-A-MX
	20 mm		★ 5228229	DSNU-S-25-20-P-A-MX		
	25 mm		★ 5228230	DSNU-S-25-25-P-A-MX		

## Ordering data

DSNU-S-20 ... 25 with P cushioning					
	Piston diameter	Stroke	Cylinder end cap	Part no.	Type
	25 mm	30 mm	Mounting thread, end cap	★ 5228231	DSNU-S-25-30-P-A-MX
		40 mm		★ 5228232	DSNU-S-25-40-P-A-MX
		50 mm		★ 5228233	DSNU-S-25-50-P-A-MX
		60 mm		★ 5228234	DSNU-S-25-60-P-A-MX
		80 mm		★ 5228235	DSNU-S-25-80-P-A-MX
		100 mm		★ 5228236	DSNU-S-25-100-P-A-MX
		125 mm		★ 5228237	DSNU-S-25-125-P-A-MX
		150 mm		★ 5228238	DSNU-S-25-150-P-A-MX
		200 mm		★ 5228239	DSNU-S-25-200-P-A-MX

DSNU-S-16 with PPS cushioning					
	Piston diameter	Stroke	Cylinder end cap	Part no.	Type
	16 mm	25 mm	Transverse supply port, end cap	★ 5217238	DSNU-S-16-25-PPS-A-MQ
		30 mm		★ 5217239	DSNU-S-16-30-PPS-A-MQ
		40 mm		★ 5217240	DSNU-S-16-40-PPS-A-MQ
		50 mm		★ 5217241	DSNU-S-16-50-PPS-A-MQ
		60 mm		★ 5217242	DSNU-S-16-60-PPS-A-MQ
		80 mm		★ 5217243	DSNU-S-16-80-PPS-A-MQ
		100 mm		★ 5217244	DSNU-S-16-100-PPS-A-MQ
		125 mm		★ 5217245	DSNU-S-16-125-PPS-A-MQ
		150 mm		★ 5217246	DSNU-S-16-150-PPS-A-MQ
		200 mm		★ 5217248	DSNU-S-16-200-PPS-A-MQ

DSNU-S-20 ... 25 with PPS cushioning					
	Piston diameter	Stroke	Cylinder end cap	Part no.	Type
	20 mm	25 mm	Mounting thread, end cap	★ 5225836	DSNU-S-20-25-PPS-A-MX
		30 mm		★ 5225837	DSNU-S-20-30-PPS-A-MX
		40 mm		★ 5225838	DSNU-S-20-40-PPS-A-MX
		50 mm		★ 5225839	DSNU-S-20-50-PPS-A-MX
		60 mm		★ 5225840	DSNU-S-20-60-PPS-A-MX
		80 mm		★ 5225841	DSNU-S-20-80-PPS-A-MX
		100 mm		★ 5225842	DSNU-S-20-100-PPS-A-MX
		125 mm		★ 5225843	DSNU-S-20-125-PPS-A-MX
		150 mm		★ 5225844	DSNU-S-20-150-PPS-A-MX
		200 mm		★ 5225846	DSNU-S-20-200-PPS-A-MX
	25 mm	25 mm	★ 5228452	DSNU-S-25-25-PPS-A-MX	
		30 mm	★ 5228453	DSNU-S-25-30-PPS-A-MX	
		40 mm	★ 5228454	DSNU-S-25-40-PPS-A-MX	
		50 mm	★ 5228455	DSNU-S-25-50-PPS-A-MX	
		60 mm	★ 5228456	DSNU-S-25-60-PPS-A-MX	
		80 mm	★ 5228457	DSNU-S-25-80-PPS-A-MX	
		100 mm	★ 5228458	DSNU-S-25-100-PPS-A-MX	
		125 mm	★ 5228459	DSNU-S-25-125-PPS-A-MX	
		150 mm	★ 5228460	DSNU-S-25-150-PPS-A-MX	
		200 mm	★ 5228461	DSNU-S-25-200-PPS-A-MX	

Modular product system				Further information → dsnu-s	
	Piston diameter	Stroke <sup>1)</sup>	Part no.	Type	
	8 mm	1 ... 100 mm	8112002	DSNU-S-8- -	
	12 mm	1 ... 150 mm	8112003	DSNU-S-12- -	
	16 mm	1 ... 200 mm	8112004	DSNU-S-16- -	
	20 mm		8112005	DSNU-S-20- -	
	25 mm		8112006	DSNU-S-25- -	

1) Also available with longer strokes on request.

## Ordering data

Modular product system – For the production of Li-ion batteries			Further information → dsnu-s	
	Piston diameter	Stroke <sup>1)</sup>	Part no.	Type
	8 mm	1 ... 100 mm	8148785	DSNU-S-8- -F1A-
	12 mm	1 ... 150 mm	8148786	DSNU-S-12- -F1A-
	16 mm	1 ... 200 mm	8148787	DSNU-S-16- -F1A-
	20 mm		8148788	DSNU-S-20- -F1A-
	25 mm		8148789	DSNU-S-25- -F1A-

1) Also available with longer strokes on request.

## Peripherals

### Peripherals overview

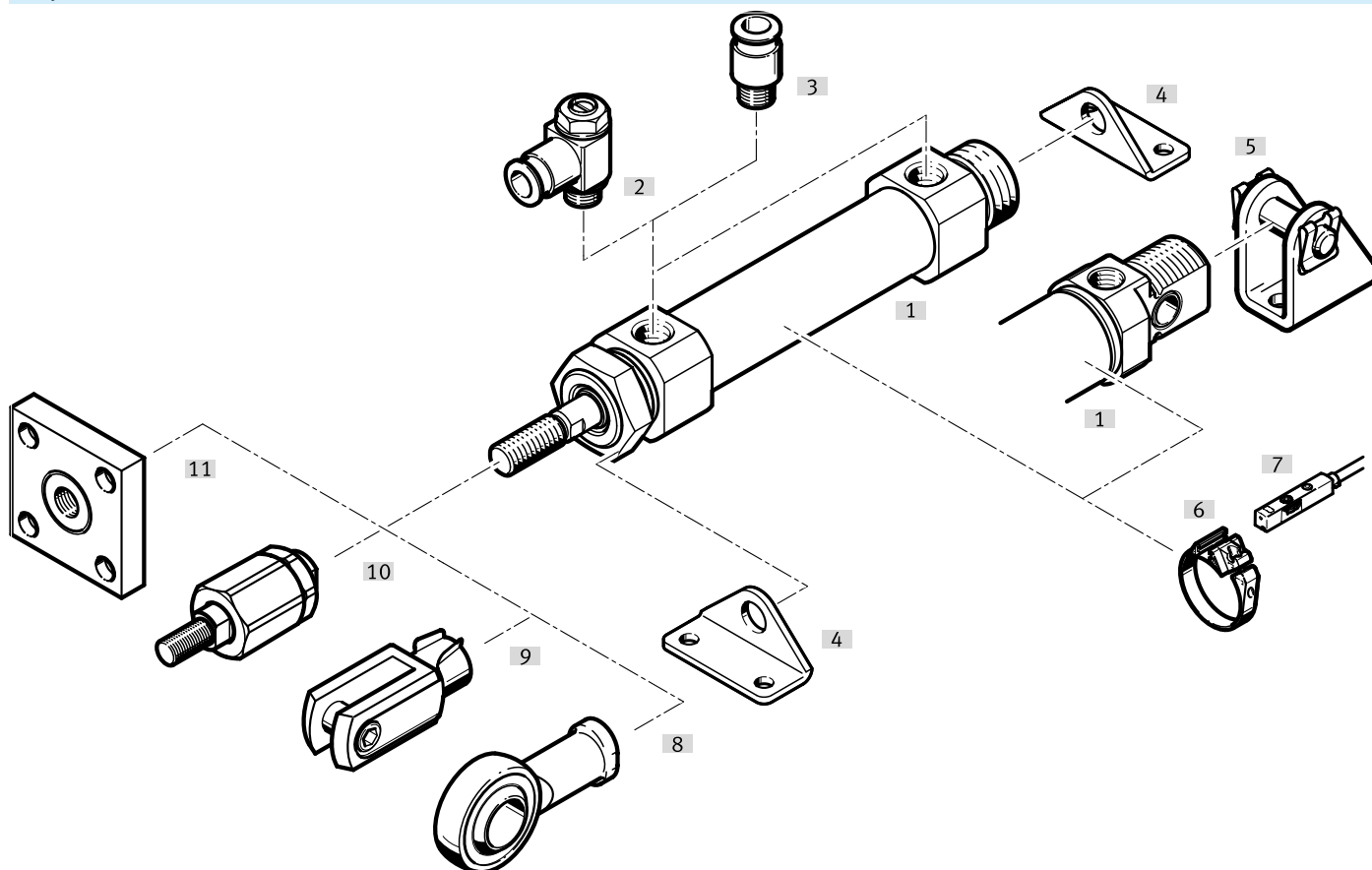

Accessories		→ Page/Internet
Type/order code	Description	
[1] Round cylinder DSNU-S	Round cylinder, space-saving	dsnu-s
[2] One-way flow control valve GRLA/GRLZ	For regulating speed	27
[3] Push-in fitting QS	For connecting tubing with standard O.D.	qs
[4] Foot mounting HBN-S	For bearing or end caps	24
[5] Clevis foot LBN	For bearing cap	24
[6] Mounting kit SMBR	For proximity switches and position transmitters	27
[7] Proximity switch SMT/SDBT	Can be integrated in the cylinder profile	25
[7] Position transmitter SDAS/SDAT/SMAT	<ul style="list-style-type: none"> <li>Continuously senses the position of the piston</li> <li>Has an analogue output</li> </ul>	26
[8] Rod eye SGS	With spherical bearing	24
[9] Rod clevis SG	Permits a swivelling movement of the cylinder in one plane	24
[10] Self-aligning rod coupler FK/DARP	To compensate for radial and angular deviations	24
[11] Coupling piece KSG	To compensate for radial deviations	25

## Accessories

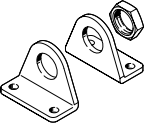
Foot mounting HBN-S					
	Size	Material mounting <sup>1)</sup>	Product weight	Part no.	Type
	8	Galvanised steel	12 g	★ 5407712	HBN-S-8X1
			26 g	8185945	HBN-S-8X2
		Steel, chemically nickel-plated	12 g	8148809	HBN-S-8X1-F1A
	12, 16	Galvanised steel	30 g	★ 5407772	HBN-S-12/16X1
			63 g	8185946	HBN-S-12/16X2
		Steel, chemically nickel-plated	30 g	8148808	HBN-S-12/16X1-F1A
	20, 25	Galvanised steel	77 g	★ 5407787	HBN-S-20/25X1
			165 g	★ 5407847	HBN-S-20/25X2
		Steel, chemically nickel-plated	77 g	8148811	HBN-S-20/25X1-F1A
			166 g	8148810	HBN-S-20/25X2-F1A

1) HBN-S-...-F1A: Recommended for production lines for the manufacture of Li-ion batteries. More information [www.festo.com/x/topic/bat](http://www.festo.com/x/topic/bat)

Clevis foot LBN					
	Description	Material mounting	Product weight	Part no.	Type
	For Ø 8/12	Steel, Galvanised	20 g	6057	LBN-8/10
	For Ø 16		40 g	★ 6058	LBN-12/16
	For Ø 20/25		84 g	★ 6059	LBN-20/25

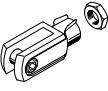
Rod clevis SG					
	Description	Material clevis	Product weight	Part no.	Type
	for Ø 8	Steel, Galvanised	8 g	6532	SG-M4
	for Ø 12, 16		22 g	★ 3110	SG-M6
	for Ø 20		53 g	★ 3111	SG-M8
	for Ø 25		103 g	★ 6144	SG-M10X1,25

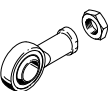
Rod eye SGS					
	Description	Material housing	Product weight	Part no.	Type
	for Ø 8	Galvanised steel	21 g	9253	SGS-M4
	for Ø 12/16		30 g	★ 9254	SGS-M6
	for Ø 20		54 g	★ 9255	SGS-M8
	for Ø 25		88 g	★ 9261	SGS-M10X1,25

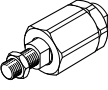
Self-aligning rod coupler FK					
	Description	Material housing	Product weight	Part no.	Type
	For Ø 8	Steel, Galvanised	15 g	6528	FK-M4
	For Ø 12, 16		23 g	★ 2061	FK-M6
	For Ø 20		50 g	★ 2062	FK-M8
	For Ø 25		210 g	★ 6140	FK-M10X1,25

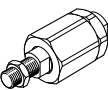
Self-aligning rod coupler DARP					
	Description	Material housing <sup>1)</sup>	Product weight	Part no.	Type
	for Ø 8	High-alloy stainless steel	17 g	8170110	DARP-M4-F
	for Ø 12, 16		25 g	8170115	DARP-M6-F
	for Ø 20		58 g	8170116	DARP-M8-F
	for Ø 25		236 g	8170119	DARP-M10P-F

1) DARP-....: Recommended for production lines for the manufacture of Li-ion batteries. Further information [www.festo.com/x/topic/bat](http://www.festo.com/x/topic/bat)

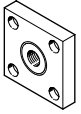

## Accessories

Coupling piece KSG						
	Description	Material mounting	Product weight	Part no.	Type	
	For Ø 25	Steel, Galvanised	229 g	32963	KSG-M10X1,25	

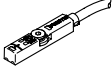
Proximity switch SMT-8M for T-slot, magneto-resistive						
	Type of mounting	Switching output	Electrical connection	Cable length	Part no.	Type
	Screw-clamped, Insertable in the slot from above	3-wire NPN N/O contact	Open end	2.5 m	★ 574338	SMT-8M-A-NS-24V-E-2,5-OE
			Plug M8, A-coded	0.3 m	★ 574339	SMT-8M-A-NS-24V-E-0,3-M8D
		3-wire PNP N/O contact	Open end	2.5 m	★ 574335	SMT-8M-A-PS-24V-E-2,5-OE
			Plug M8, A-coded	0.3 m	★ 574334	SMT-8M-A-PS-24V-E-0,3-M8D
		2-wire PNP N/O contact	Open end	5 m	★ 8165237	SMT-8M-A-ZS-24V-E-5,0-OE

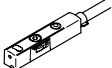
Proximity switch SDBT-MSX for T-slot, magnetic Hall						
	Switching output	Switching element function	Electrical connection	Cable length	Part no.	Type
	PNP/NPN, switchable	N/C or N/O contact, switchable	Open end	2.5 m	★ 8059121	SDBT-MSX-1L-PU-E-2.5-N-LE
			Plug M8, A-coded	0.3 m	★ 8059124	SDBT-MSX-1L-NU-E-2.5-N-LE
			Plug M8, A-coded	0.3 m	★ 8059123	SDBT-MSX-1L-NU-E-0.3-N-M8
					★ 8059120	SDBT-MSX-1L-PU-E-0.3-N-M8

Mounting kits SMBR for proximity switches						
	Size	Material profile	Part no.	Type		
	8	Wrought aluminium alloy	175091	SMBR-8-8		
	12		★ 175093	SMBR-8-12		
	16		★ 175094	SMBR-8-16		
	20		★ 175095	SMBR-8-20		
	25		★ 175096	SMBR-8-25		

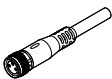
Connecting cables NEBU, straight, M8 connection						
	Electrical connection 1, connector system	Electrical connection 2, connector system	Electrical connection 2, number of connections/cores	Cable length	Part no.	Type
	M8x1, A-coded, to EN 61076-2-104	Open end	3	2.5 m	★ 541333	NEBU-M8G3-K-2.5-LE3
				5 m	★ 541334	NEBU-M8G3-K-5-LE3

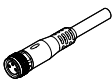
Connecting cables NEBU, straight, M12 connection						
	Electrical connection 1, connector system	Electrical connection 2, connector system	Electrical connection 2, number of connections/cores	Cable length	Part no.	Type
	M12x1, A-coded to EN 61076-2-101	Open end	3	2.5 m	★ 541363	NEBU-M12G5-K-2.5-LE3
				5 m	★ 541364	NEBU-M12G5-K-5-LE3

Accessories

Connecting cables NEBU, angled, M8 connection

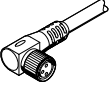
	Electrical connection 1, connector system	Electrical connection 2, connector system	Electrical connection 2, number of connections/cores	Cable length	Part no.	Type
	M8x1, A-coded, to EN 61076-2-104	Open end	3	2.5 m	★ 541338	NEBU-M8W3-K-2.5-LE3
				5 m	★ 541341	NEBU-M8W3-K-5-LE3

Connecting cables NEBU, angled, M12 connection

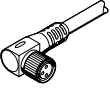
	Electrical connection 1, connector system	Electrical connection 2, connector system	Electrical connection 2, number of connections/cores	Cable length	Part no.	Type
	M12x1, A-coded to EN 61076-2-101	Open end	3	2.5 m	541367	NEBU-M12W5-K-2.5-LE3
				5 m	541370	NEBU-M12W5-K-5-LE3

Position transmitter SDAS for T-slot, plug M8, A-coded

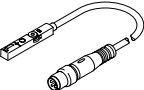
	Description	Sensing range	Electrical connection 1, number of connections/cores	Cable length	Part no.	Type
	Operating modes: two adjustable switching outputs; IO-Link®	52 mm	4	0.3 m	8063974	SDAS-MHS-M40-1L-PNLK-PN-E-0.3-M8

Position transmitter SDAT for T-slot, connector M8, A-coded

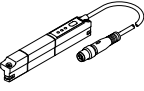
	Sensing range	Analogue output	Electrical connection 1, number of connections/cores	Cable length	Part no.	Type
	0 ... 50.000 mm	4 - 20 mA	4	0.3 m	1531265	SDAT-MHS-M50-1L-SA-E-0.3-M8
	0 ... 80.000 mm				1531266	SDAT-MHS-M80-1L-SA-E-0.3-M8
	0 ... 100.000 mm				1531267	SDAT-MHS-M100-1L-SA-E-0.3-M8
	0 ... 125.000 mm				1531268	SDAT-MHS-M125-1L-SA-E-0.3-M8
	0 ... 160.000 mm				1531269	SDAT-MHS-M160-1L-SA-E-0.3-M8

Position transmitter SMAT-8M for T-slot, plug M8, A-coded

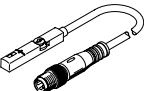
	Sensing range	Analogue output	Electrical connection 1, number of connections/cores	Cable length	Part no.	Type
	52 mm	0 - 10 V	4	0.3 m	553744	SMAT-8M-U-E-0,3-M8D

## Accessories

Mounting kits SMBR for position transmitters					
	Size	Material profile	Part no.	Type	
	8	Wrought aluminium alloy	175091	SMBR-8-8	
	12		★ 175093	SMBR-8-12	
	16		★ 175094	SMBR-8-16	
	20		★ 175095	SMBR-8-20	
	25		★ 175096	SMBR-8-25	

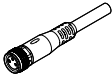
Connecting cables NEBU, straight						
	Electrical connection 1, connector system	Electrical connection 2, connector system	Electrical connection 2, number of connections/cores	Cable length	Part no.	Type
	M8x1, A-coded, to EN 61076-2-104	Open end	4	2.5 m	541342	NEBU-M8G4-K-2.5-LE4
				5 m	541343	NEBU-M8G4-K-5-LE4

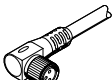
Connecting cables NEBU, angled						
	Electrical connection 1, connector system	Electrical connection 2, connector system	Electrical connection 2, number of connections/cores	Cable length	Part no.	Type
	M8x1, A-coded, to EN 61076-2-104	Open end	4	2.5 m	541344	NEBU-M8W4-K-2.5-LE4
				5 m	541345	NEBU-M8W4-K-5-LE4

One-way flow control valves GRLA – For exhaust air					
	Description	Pneumatic connection 1	Pneumatic connection, port 2	Part no.	Type
	For Ø 8...16	Push-in connector 3 mm	M5	★ 193137	GRLA-M5-QS-3-D
		Push-in connector 4 mm		★ 193138	GRLA-M5-QS-4-D
		Push-in connector 6 mm		★ 193139	GRLA-M5-QS-6-D
	For Ø 20...25	Push-in connector 3 mm	G1/8	193142	GRLA-1/8-QS-3-D
		Push-in connector 4 mm		★ 193143	GRLA-1/8-QS-4-D
		Push-in connector 6 mm		★ 193144	GRLA-1/8-QS-6-D
		Push-in connector 8 mm		★ 193145	GRLA-1/8-QS-8-D

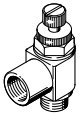
One-way flow control valves GRLZ – For supply air					
	Description	Pneumatic connection 1	Pneumatic connection, port 2	Part no.	Type
	For Ø 8...16	Push-in connector 3 mm	M5	★ 193153	GRLZ-M5-QS-3-D
		Push-in connector 4 mm		★ 193154	GRLZ-M5-QS-4-D
		Push-in connector 6 mm		★ 193155	GRLZ-M5-QS-6-D
	For Ø 20...25	Push-in connector 3 mm	G1/8	193156	GRLZ-1/8-QS-3-D

Accessories

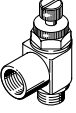
One-way flow control valves GRLZ – For supply air					
	Description	Pneumatic connection 1	Pneumatic connection, port 2	Part no.	Type
	For Ø 20...25	Push-in connector 4 mm	G1/8	★ 193157	GRLZ-1/8-QS-4-D
		Push-in connector 6 mm		★ 193158	GRLZ-1/8-QS-6-D
		Push-in connector 8 mm		★ 193159	GRLZ-1/8-QS-8-D