

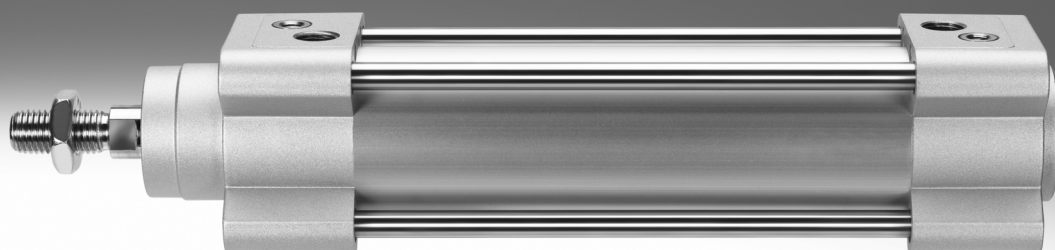



Standards-based cylinders DSBG, to ISO 15552

FESTO



Key features

At a glance

- 

- Standards-based cylinders to ISO15552 (corresponds to the withdrawn standards ISO 6431, DIN ISO 6431, VDMA24562, NFE49003.1 and UNI 10290)
 - Sturdy tie rod design
 - Double-acting
 - For contactless position sensing
 - Available with protection against rotation
 - EX4: for use in potentially explosive areas
 - A wide range of accessories enables the cylinder to be installed virtually anywhere
 - There is a choice of three types of cushioning:
 - P cushioning: elastic cushioning rings/plates at both ends
 - PPS cushioning: pneumatic cushioning, self-adjusting at both ends
 - PPV cushioning: pneumatic cushioning, adjustable at both ends
 - The variants can be configured according to individual needs using a modular product system
 - Excellent flexibility thanks to a wide range of variants

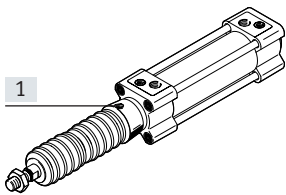
DSBG-...-P2 – with bellows kit DADB, to ISO 15552



The bellows protects the piston rod, the seal and the bearing from the effects of a wide range of media, which has a positive impact on the service life of these components.

The bellows kit is a leak-free system. To prevent unwanted media from being drawn in, the supply and exhaust air for the kit must be ducted via a pressure compensation hole in the connection part [1].

The kit protects the piston rod, seal and bearing against a wide variety of media, for example:

- Dust
- Chippings
- Oil
- Grease
- Petrol

Ordering the bellows kit

An extended piston rod is absolutely essential if a bellows kit is to be used.

The bellows kit can be ordered via the modular product system or as an accessory. The following must be noted in this case:

Ordering via the modular product system:
The bellows kit is supplied mounted on the bearing cap using feature P2. The required piston rod extension is automatically taken into consideration. This means that there is no need to specify a value for feature ...E.

Ordering as an accessory:
If the bellows kit is ordered as an accessory, the required value → page 39 must be entered for characteristic ...E in the modular product system.

Position sensing/force control

With position transmitter SMAT, SDAT → page 43



Analogue position feedback possible

- Analogue output – 0 ... 10 V



With proportional-pressure regulator VPPM

















Stepless adjustment of the gripping force possible

- Setpoint value input – 0 ... 10 V
- 4 ... 20 mA

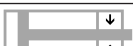
Variants from the modular product system

Symbol	Key features	Description
	Q Square piston rod	Protection against rotation. For position-oriented feeding
	L Low friction	<ul style="list-style-type: none"> • Break-away pressure: low • Dynamic response: suitable for very fast movements, especially at low operating pressures Application example: very dynamic movements with no standstill

Key features

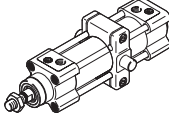
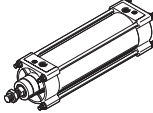
Variants from the modular product system		
Symbol	Key features	Description
	U Constant, slow movement	<ul style="list-style-type: none"> Break-away pressure: very low Dynamic response: suitable for very slow, constant and stick-slip-free movements Application example: slow, constant feed motion
	L1 Low friction for balancer applications	<ul style="list-style-type: none"> Break-away pressure: low Dynamic response: suitable for slow movements with constant application of pressure at one end. System friction is independent of operating pressure Application example: balancing of a mass (balancer, belt tensioner with constant feed motion)
	T Through piston rod	For working at both ends with the same force in the forward and return stroke, for attaching external stops
	F Female thread on the piston rod	–
	R3 High corrosion protection	All external cylinder surfaces comply with corrosion resistance class 3 to Festo standard 940 070. The piston rod is made from corrosion- and acid-resistant steel
	T1 Heat-resistant seals	Temperature range 0 ... +120 °C
	T3 Low temperature	Temperature range –40 ... +80 °C
	T4 Heat-resistant seals	Temperature range 0 ... +150 °C
	A2 Wiper variant	Hard wiper: The cylinder has a hard-chromium plated piston rod and a hard scraper, which protects against dry, dusty and viscous media
	A3 Wiper variant	Unlubricated operation: Cleaning processes degrease the piston rod. A special piston rod seal designed for unlubricated operation permits a longer service life compared to the standard seal.
	A6 Wiper variant	Metal scraper: The cylinder has a hard-chromium plated piston rod and metal scraper, which scrapes off hard particles (e.g. welding spatter) sticking to the piston rod. For use in welding systems, for example
	...E Extended piston rod	1 ... 500 mm
	...L Extended piston rod thread	1 ... 70 mm
	...S Shortened piston rod thread	1 ... 44 mm
	M... Piston rod thread	Piston rod thread version: M16/M16x1.5/M20/M20x1.5/M24/M27
	...V Swivel mounting position	<ul style="list-style-type: none"> Swivel mounting, position freely selectable Position can be moved at any time
	Thread length of spacer bolts: ...LB2 On the bearing cap ...LB3 On the end cap	<ul style="list-style-type: none"> Variable thread length: 20 ... 140 mm Optionally on the bearing or end cap

Product range overview

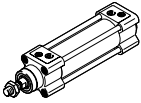
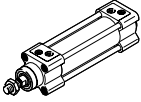
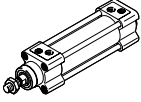
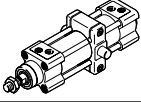
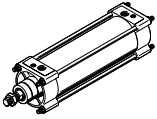
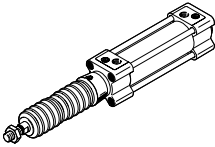
Function	Version	Type	Piston ø	Stroke	Through piston rod	Female piston rod thread	Cushioning			
			[mm]	[mm]			T	F	P	PPS
Double-acting	DSBG-...									
		DSBG-...	32, 40, 50, 63, 80, 100, 125	1 ... 2800		■	■	■	■	■
	DSBG-...-Q – With protection against rotation									
		DSBG-...-Q	32, 40, 50, 63, 80, 100	1 ... 1500		■	■	■	■	■
	DSBG-...-L/-U/-L1 – With special running characteristics									
		DSBG-...-L	32, 40, 50, 63, 80, 100	1 ... 2800		–	■	■	■	■
		DSBG-...-U	32, 40, 50, 63, 80, 100, 125	1 ... 2800		–	■	■	■	■
		DSBG-...-L1	32, 40, 50, 63, 80, 100, 125	10 ... 1000		–	■	■	■	–
	DSBG-...-...V – With swivel mounting position									
		DSBG-...-...V	32, 40, 50, 63, 80, 100, 125	10 ... 2800		■	■	■	■	■
DSBG-...-...LB2/3 – With spacer bolt on the bearing/end cap										
	DSBG-...-...LB2/3	80, 100, 125	10 ... 2800		■	■	■	■	■	
DSBG-...-P2 – With protective bellows										
	DSBG-...-P2	32, 40, 50, 63, 80, 100	10 ... 500		■	■	■	■	■	

Product range overview

Type	Position sensing	High corrosion protection	Temperature range 0 ... +120 °C	Temperature range -40 ... +80 °C	Temperature range 0 ... +150 °C	Wiper variant Hard scraper	Wiper variant For unlubricated operation	Wiper variant Metal scraper	EU certification	Extended piston rod	Extended piston rod thread	Shortened piston rod thread
	A	R3	T1	T3	T4	A2	A3	A6	EX4	..E	..L	..S
DSBG-...												
DSBG-...	■	■	■	■	■	■	■	■	■	■	■	■
DSBG-...-Q – With protection against rotation												
DSBG-...-Q	■	■	■	-	-	-	-	-	■	■	■	■
DSBG-...-L/-U/-L1 – With special running characteristics												
DSBG-...-L	■	-	-	-	-	-	-	-	-	■	■	■
DSBG-...-U	■	-	-	-	-	-	-	-	-	■	■	■
DSBG-...-L1	■	-	-	-	-	-	-	-	-	■	■	■
DSBG-...-...V – With swivel mounting position												
DSBG-...-...V	■	-	■	■	■	■	■	■	■	■	■	■
DSBG-...-...LB2/3 – With spacer bolt on the bearing/end cap												
DSBG-...-...LB2/3	■	■	■	■	■	■	■	■	■	■	■	■
DSBG-...-P2 – With protective bellows												
DSBG-...-P2	■	■	-	-	-	-	-	-	-	■	■	■

Peripherals overview

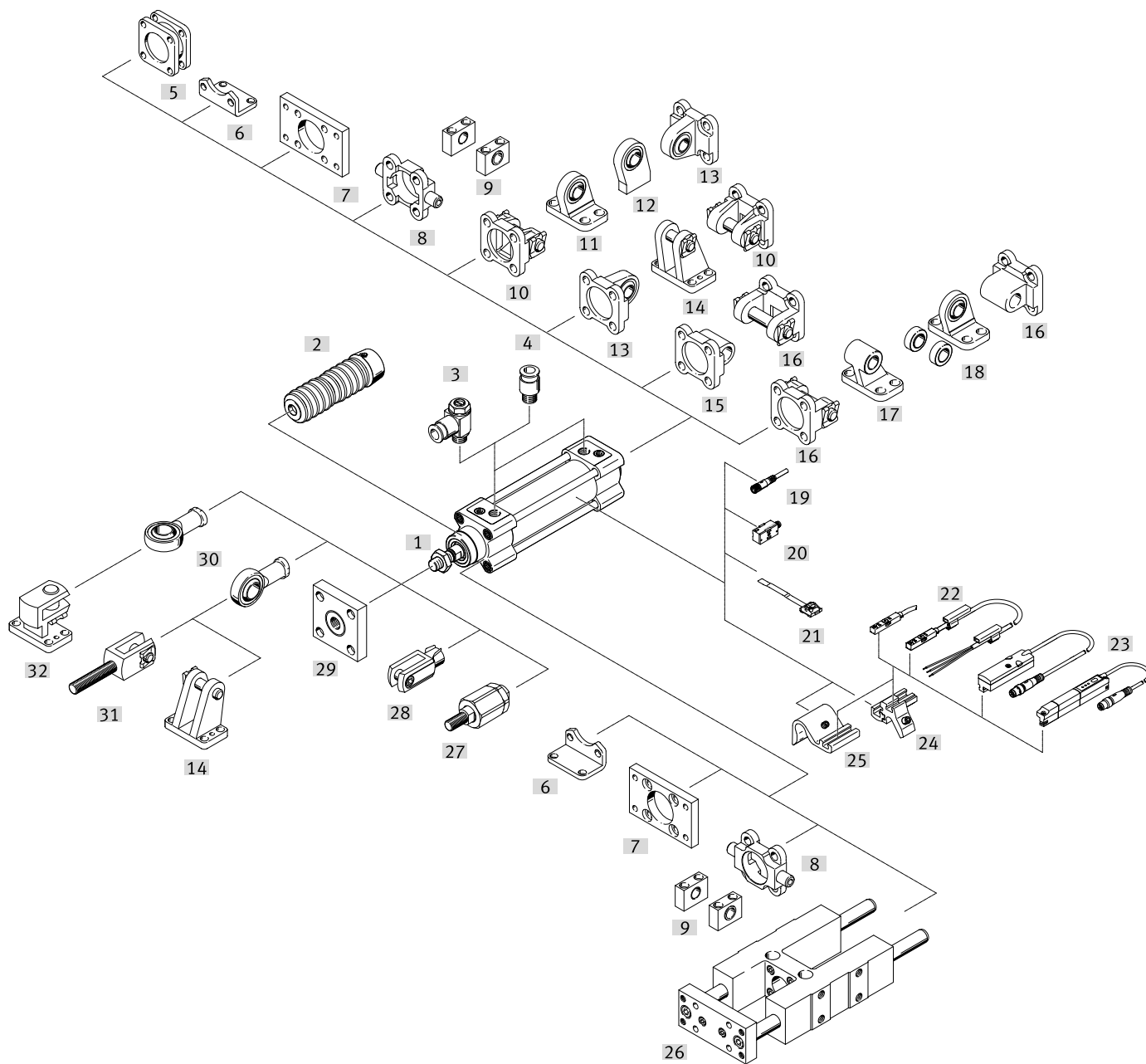

Mounting attachments and accessories

	Description	DSBG...			→ Page/ Internet
		-L/-U/ -L1	-T		
[1] Standards-based cylinder DSBG	Standards-based cylinder without accessories, basic design				9
[2] Bellows kit DADB	<ul style="list-style-type: none"> Protects the cylinder (piston rod, seal and bearing) against a wide range of media and thus prevents premature wear Can only be used in combination with an extended piston rod (E) 	■	-	■	36
[3] One-way flow control valve GRLA	For regulating speed	■	■	■	44
[4] Push-in fitting QS	For connecting tubing with standard O.D.	■	■	■	q5
[5] Multi-position kit DPNC	For connecting two cylinders with identical piston diameters to form a multi-position cylinder	■	-	■	40

Peripherals overview

Mounting attachments and accessories		Description	DSBG-...			→ Page/ Internet
				-L/-U/ -L1	-T	
[6]	Foot mounting HNC/CRHNC	For bearing or end caps	■	■	■	26
[7]	Flange mounting FNC/CRFNG	<ul style="list-style-type: none"> For bearing or end caps Cannot be used on the bearing cap in combination with bellows kit DADB 	■	■	■	27
[8]	Trunnion flange ZNC/CRZNG	<ul style="list-style-type: none"> For bearing or end caps Cannot be used on the bearing cap in combination with bellows kit DADB 	■	■	■	28
[9]	Trunnion support LNZG/CRLNZG	–	■	■	■	29
[10]	Swivel flange SNC	For end caps	■	■	–	30
[11]	Clevis foot LSNG	With spherical bearing	■	■	–	34
[12]	Clevis foot LSNSG	Weld-on, with spherical bearing	■	■	–	34
[13]	Swivel flange SNCS/CRSNCS/SNCS-...-R3	With spherical bearing for end caps	■	■	–	32
[14]	Clevis foot LBG/LBG-...-R3	–	■	■	–	34
[15]	Swivel flange SNCL	For end caps	■	■	–	33
[16]	Swivel flange SNCB/SNCB-...-R3	For end caps	■	■	–	31
[17]	Clevis foot LNG/CRLNG	–	■	■	–	34
[18]	Clevis foot LSN	With spherical bearing	■	■	–	34
[19]	Connecting cable NEBU	–	■	■	■	43
[20]	Proximity switch SMPO-1-H-B	–	■	■	■	44
[21]	Mounting kit SMBS	For proximity switch SMPO-1-H-B	■	■	■	43
[22]	Proximity switch SME/SMT-8M/SDBT-MS	Can be integrated in the cylinder profile barrel	■	■	■	42
[23]	Position transmitter SMAT, SDAT	<ul style="list-style-type: none"> Continuously senses the position of the piston Has an analogue output 	■	■	■	43
[24]	Mounting kit SMBZ-8- ...	For proximity switch SME/SMT-8M, with piston diameter 32 ... 100	■	■	■	43
[25]	Sensor bracket DASP-M4- ...	For proximity switch SME/SMT-8M, with piston diameter 125	■	■	■	43
[26]	Guide unit FENG	For protecting standards-based cylinders against rotation at high torques	■	■	■	41
[27]	Self-aligning rod coupler FK, CRFK	To compensate for radial and angular deviations	■	■	■	35
[28]	Rod clevis SG/CRSG	Permits a swivelling movement of the cylinder in one plane	■	■	■	35
[29]	Coupling piece KSG	To compensate for radial deviations	■	■	■	35
	Coupling piece KSZ	For cylinders with a non-rotating piston rod to compensate radial deviations	■	■	■	35
[30]	Rod eye SGS/CRSGS	With spherical bearing	■	■	■	35
[31]	Rod clevis SGA	With male thread	■	■	■	35
[32]	Right-angle clevis foot LQG	–	■	■	■	34

Type codes

001	Series	
DSBG	Standards-based cylinder, double-acting, based on ISO 15552	
002	Protection against rotation	
	None	
Q	With protection against rotation	
003	Running characteristics	
	Standard	
L	Low friction	
U	Uniform, slow movement	
L1	Low friction for balancer applications	
004	Piston diameter	
32	32	
40	40	
50	50	
63	63	
80	80	
100	100	
125	125	
005	Stroke	
...	25 ... 500	
006	Piston rod type	
	At one end	
T	Through piston rod	
007	Piston rod thread type	
	Male thread	
F	Female thread	
008	Cushioning	
P	Elastic cushioning rings/plates on both sides	
PPV	Pneumatic cushioning, adjustable at both ends	
PPS	Pneumatic cushioning, self-adjusting at both ends	
009	Position sensing	
	None	
A	For proximity sensor	
010	Standard	
	Not according to standard	
N3	Conforms to ISO 15552	
011	Corrosion protection	
	Standard	
R3	High corrosion protection	

012	Temperature range	
	Standard	
T1	Heat-resistant seals max. 120°C	
T3	-40 ... +80°C	
T4	0 ... +150°C	
013	Protection against particles	
	Standard	
P2	Bellows on bearing cap	
014	Scraper variant	
	None	
A2	Hard scraper	
A3	For unlubricated operation	
A6	Metal scraper	
015	EU certification	
	None	
EX4	II 2GD	
016	Swivel mounting position	
	None	
...V	163 ... 2483 mm	
017	Piston rod extension	
	None	
...E	1 ... 500 mm	
018	Piston rod thread extension	
...	1 ... 70	
019	Piston rod thread shortening	
	None	
...S	0 ... 86 mm	
020	Piston rod thread	
	Standard	
M16	M16	
M16P	M16x1.5	
M20	M20	
M20P	M20x1.5	
M24	M24	
M27	M27	
021	Thread length of spacer bolts on bearing cap	
	Without spacer bolt	
...LB2	20...140 mm	
022	Thread length of spacer bolts on end cap	
	Without spacer bolt	
...LB3	20...140 mm	

Datasheet

Function

P cushioning

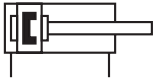

⌀ - Diameter
32 ... 125 mm

Adjustable pneumatic cushioning

PPV

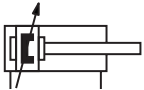

- | - Stroke length
1 ... 2800 mm



www.festo.com

PPS cushioning

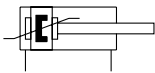

- ⚙ - Repair service
Piston ⌀ 125 mm

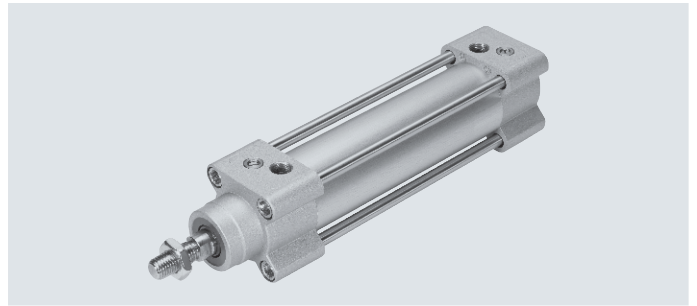

General technical data

Piston ⌀	32	40	50	63	80	100	125
Design	Piston/piston rod/cylinder barrel						
Operating mode	Double-acting						
Pneumatic connection	G1/8	G1/4	G1/4	G3/8	G3/8	G1/2	G1/2
Stroke							
DSBG-... [mm]	1 ... 2800						
DSBG-...-Q [mm]	1 ... 1500						-
DSBG-...-L1 [mm]	10 ... 1000						
DSBG-...-P2 [mm]	10 ... 500						-
DSBG-...-...E [mm]	1 ... 2000						
DSBG-...-...L [mm]	1 ... 2000						
Cushioning							
DSBG-...-P	Elastic cushioning rings/plates at both ends						
DSBG-...-PPV	Pneumatic cushioning, adjustable at both ends						
DSBG-...-PPS	Pneumatic cushioning, self-adjusting at both ends						
Cushioning length							
DSBG-...-PPV [mm]	17	19	22	22	31	31	45
Position sensing	Via proximity switch						
Type of mounting	With female thread/accessories						
Mounting position	Any						

Datasheet

Operating and environmental conditions								
Piston Ø		32	40	50	63	80	100	125
Operating medium		Compressed air to ISO 8573-1:2010 [7:4:4]						
Note on the operating/pilot medium		Lubricated operation possible (in which case lubricated operation will always be required)						
Operating pressure								
DSBG-...	[MPa]	0.06 ... 1.2		0.04 ... 1.2			0.02 ... 1.0	
	[bar]	0.6 ... 12		0.4 ... 12			0.2 ... 10	
DSBG-...-Q	[MPa]	0.1 ... 1.2						–
	[bar]	1 ... 12						–
DSBG-...-Q-T1	[MPa]	0.1 ... 0.8						–
	[bar]	1 ... 8						–
DSBG-...-L ¹⁾	[MPa]	0.03 ... 1.2	0.025 ... 1.2		0.02 ... 1.2	0.015 ... 1.2		–
	[bar]	0.3 ... 12	0.25 ... 12		0.2 ... 12	0.15 ... 12		–
DSBG-...-U ¹⁾	[MPa]	0.01 ... 1.2			0.005 ... 1.2			0.005 ... 1.0
	[bar]	0.1 ... 12			0.05 ... 12			0.05 ... 10
DSBG-...-L1 ¹⁾	[MPa]	0.03 ... 1.2	0.025 ... 1.2		0.02 ... 1.2	0.015 ... 1.2		0.01 ... 1.0
	[bar]	0.3 ... 12	0.25 ... 12		0.2 ... 12	0.15 ... 12		0.1 ... 10
DSBG-...-T/-T3/-A2	[MPa]	0.1 ... 1.2						0.1 ... 1.0
	[bar]	1 ... 12						1 ... 10
DSBG-...-T3-A6	[MPa]	0.15 ... 1.2						
	[bar]	1.5 ... 12						
DSBG-...-A3	[MPa]	0.15 ... 1.2	0.1 ... 1.2		0.06 ... 1.2		0.06 ... 1.0	
	[bar]	1.5 ... 12	1 ... 12		0.6 ... 12		0.6 ... 10	
DSBG-...-A6	[MPa]	0.15 ... 1.2						
	[bar]	1.5 ... 12						
Ambient temperature ²⁾								
DSBG-...	[°C]	–20 ... +80						
DSBG-...-L/-U	[°C]	+5 ... +80						
DSBG-...-L1	[°C]	0 ... +60						
DSBG-...-A1	[°C]	0 ... +80						
DSBG-...-A6	[°C]	–20 ... +80						
DSBG-...-T1-A6	[°C]	0 ... +120						
DSBG-...-T3-A6	[°C]	–40 ... +80						
DSBG-...-T4-A6	[°C]	0 ... +150						
DSBG-...-T1	[°C]	0 ... +120						
DSBG-...-T3	[°C]	–40 ... +80						
DSBG-...-T4	[°C]	0 ... +150						
DSBG-...-P2	[°C]	–10 ... +80						–
DSBG-...-EX4	[°C]	–20 ... +60						
Corrosion resistance class CRC ³⁾								
DSBG-...		2 - Moderate corrosion stress						
DSBG-...-R3		3 - High corrosion stress						

- 1) Values apply only for strokes ≤ 500 mm and after 10 double strokes.
In combination with cushioning PPV/PPS, the specifications only apply outside the cushioning range
- 2) Note operating range of proximity switches.
- 3) More information: www.festo.com/x/topic/crc

Weight [g]								
Piston Ø		32	40	50	63	80	100	125
DSBG-...								
Product weight with 0 mm stroke		465	740	1190	1740	2660	3665	6611
Additional weight per 10 mm stroke		25	35	52	55	85	94	143
Moving mass with 0 mm stroke		110	205	365	430	810	1000	2245
Moving mass per 10 mm stroke		9	16	25	25	39	39	63
DSBG-...-Q								
Product weight with 0 mm stroke		503	755	1241	1821	2717	3827	–
Additional weight per 10 mm stroke		24	30	47	50	78	87	–
Moving mass with 0 mm stroke		103	170	332	391	757	890	–
Moving mass per 10 mm stroke		8	11	20	20	32	32	–

Datasheet

Weight [g]							
Piston ø	32	40	50	63	80	100	125
DSBG-...-L1							
Product weight with 0 mm stroke	465	741	1200	1759	2651	3693	6651
Additional weight per 10 mm stroke	25	35	52	55	85	94	143
Moving mass with 0 mm stroke	110	206	375	449	801	1028	2285
Moving mass per 10 mm stroke	9	16	25	25	39	39	63
DSBG-...-T							
Product weight with 0 mm stroke	581	924	1523	2103	3243	4353	7450
Additional weight per 10 mm stroke	34	51	77	80	124	133	206
Moving mass with 0 mm stroke	181	339	613	684	1292	1516	3084
Moving mass per 10 mm stroke	18	32	50	50	78	78	126
DSBG-...-F							
Product weight with 0 mm stroke	453	721	1145	1695	2570	3575	6389
Additional weight per 10 mm stroke	25	35	52	55	85	94	143
Moving mass with 0 mm stroke	98	186	320	385	720	910	2023
Moving mass per 10 mm stroke	9	16	25	25	39	39	63
DSBG-...E							
Additional weight per piston rod extension of 10 mm	9	16	25	25	39	39	63
DSBG-...L							
Additional weight per piston rod extension of 10 mm	6	8	14	14	22	22	41

ATEX¹⁾	
ATEX category for gas	II 2G
Type of ignition protection for gas	Ex h IIC T4 Gb
ATEX category for dust	II 2D
Type of ignition protection for dust	Ex h IIIC T120°C Db
Explosion-proof ambient temperature	-20 °C ≤ Ta ≤ +60 °C
CE marking (see declaration of conformity)	To EU Explosion Protection Directive (ATEX)
UKCA marking (see declaration of conformity)	According to UK explosion regulations
Explosion protection certification outside the EU	EPL Gb (GB) EPL Db (GB)

1) Note the ATEX certification of the accessories.

Forces [N] and impact energy [J]							
Piston ø	32	40	50	63	80	100	125
Theoretical force at 6 bar, advancing	483	754	1178	1870	3016	4712	7363
Theoretical force at 6 bar, retracting	415	633	990	1682	2721	4418	6881
Max. impact energy in the end positions							
DSBG-...	0.4	0.7	1.0	1.3	1.8	2.5	3.3
DSBG-...-L/-U/-T1/-T3/-T4	0.2	0.35	0.5	0.65	0.9	1.25	1.65
DSBG-...-L1	0.1	0.2	0.3	0.4	0.9	1.25	1.65

Permissible impact velocity:
$$V = \sqrt{\frac{2 \times E}{m_1 + m_2}}$$

Maximum permissible mass:
$$m_2 = \frac{2 \times E}{v^2} - m_1$$

V Permissible impact speed
E Max. impact energy
m1 Moving mass (drive)
m2 Moving payload

Datasheet

Materials

Sectional view

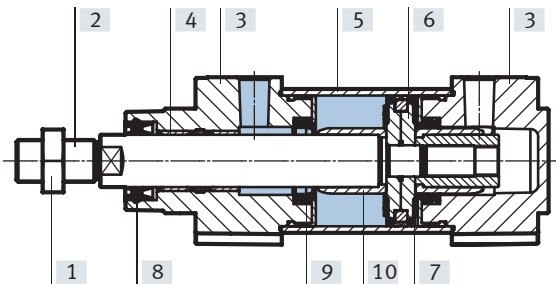

Standards-based cylinder

[1]	Nut	Galvanised steel
[2]	Piston rod	
	DSBG-...	High-alloy steel
	DSBG-...-R3	High-alloy stainless steel
	DSBG-...-A2/-A6/-T3-A6	Hard-chrome-plated tempered steel
	DSBG-...-T1-A6	High-alloy stainless steel, hard chrome-plated
[3]	Cover	Coated die-cast aluminium
[4]	Bearings	
	DSBG-...	POM
	DSBG-...-A2	Bronze
	DSBG-...-L/-U/-T1/-T1-A6/-T4-A6	Metal polymer compound
[5]	Cylinder barrel	Anodised wrought aluminium alloy
[6]	Piston	Anodised wrought aluminium alloy
[7]	Piston seal	
	DSBG-...	TPE-U (PU)
	DSBG-...-L/-U/-T1/-T4	FPM
	DSBG-...-T3	TPE-U (PU) (suitable for low temperatures)
	DSBG-...-L1	HNBR
[8]	Piston rod wiper seal	
	DSBG-...	TPE-U (PU)
	DSBG-...-L/-U	FPM
	DSBG-...-L1	HNBR
	DSBG-...-T1/-T4/-A1	FPM
	DSBG-...-T3	TPE-U (PU) (suitable for low temperatures)
	DSBG-...-A3	UHMW-PE
[9]	Buffer seal	
	DSBG-...	PUR
	DSBG-...-L	TPE-U (PU)
	DSBG-...-U/-T1/-T1-A6/-T4	FPM
	DSBG-...-T3	PUR (suitable for low temperatures)
[10]	Cushioning boss	
	DSBG-...	POM
	DSBG-...-L/-T1/-T1-A6	Metal polymer compound
	DSBG-...-T4/-T4-A6	Anodised wrought aluminium alloy
-	Tie rods	
	DSBG-...	High-alloy steel
	DSBG-...-R3	High-alloy stainless steel
-	Piston rod scraper	
	DSBG-...-A6/-T3-A6	CuZn
	DSBG-...	POM
	DSBG-...-L/-U	Aluminium
	DSBG-...-T1/-T3/-T4	Aluminium
	DSBG-...-T4-A6	Brass
-	Spacer bolt	
	DSBG-...-...LB2/-...LB3	High-alloy stainless steel
-	Swivel mounting	
	DSBG-...-...V	Painted spheroidal graphite cast iron
-	Collar nut	Galvanised steel
-	Note on materials	RoHS-compliant
	LABS (PWIS) conformity	
	DSBG-...	VDMA 24364-B1/B2-L
	DSBG-...-L/U/-T3/-T4/-A3	VDMA 24364-Zone III
	Cleanroom class	
	DSBG-32 ... 50	Class 6 to ISO 14644-1

Datasheet

Max. transverse force F_q as a function of stroke length l

Horizontal installation

Vertical installation

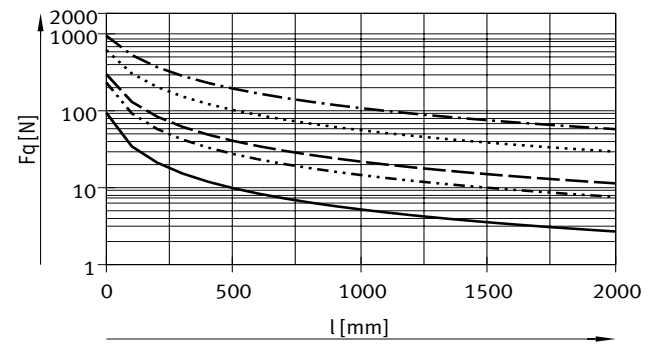
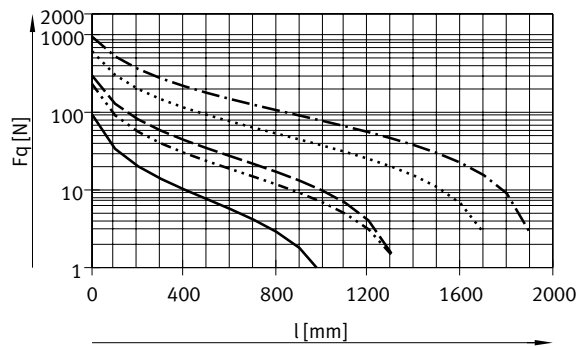

- $\varnothing 32$
- · - · - $\varnothing 40$
- - - $\varnothing 50/63$
- · · · · $\varnothing 80/100$
- · - · - $\varnothing 125$

Note
No transverse loads are permitted in combination with characteristic DSBG-...-L1.

Permissible torsional backlash for variant Q – with protection against rotation							
Piston \varnothing		32	40	50	63	80	100
Torsional backlash	[°]	±0.65	±0.6	±0.45	±0.45	±0.45	±0.45

Datasheet

Max. transverse force F_q as a function of stroke length l and lever arm s

Q – With protection against rotation

$\varnothing 32$

$\varnothing 40$

Max. torque = 800 Nmm/max. stroke = 300 mm

Max. torque = 1100 Nmm/max. stroke = 400 mm

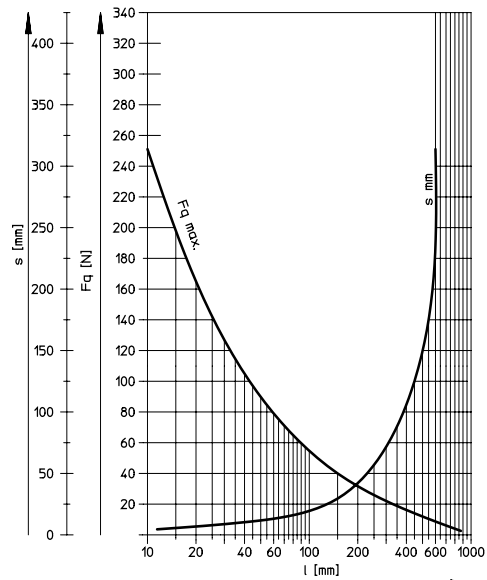
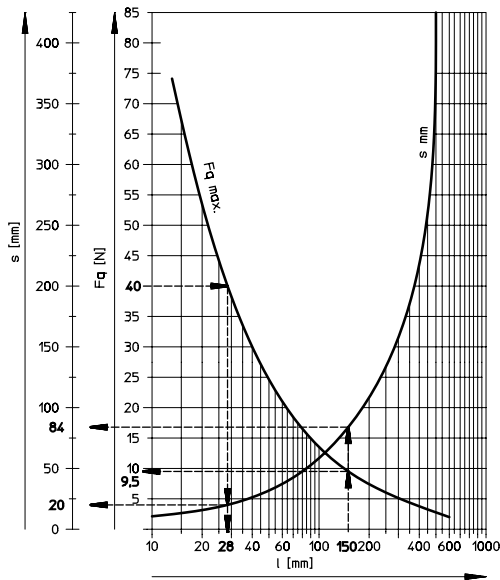

$\varnothing 50/63$

$\varnothing 80/100$

Max. torque = 1500 Nmm/max. stroke = 500 mm

Max. torque = 3000 Nmm/max. stroke = 600 mm

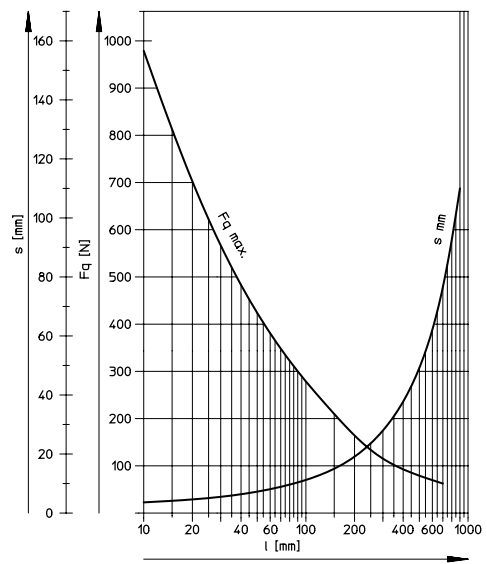
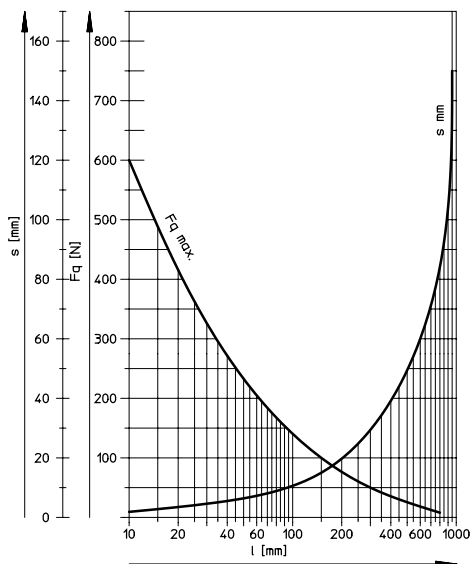

Datasheet

Examples for piston diameter 32 mm

Example 1:

Stroke length l = 150 mm

Result: permissible

Lateral force F_q = 9.5 N

Lever arm s = 84 mm

Example 2:

Lateral force F_q = 40°N

Result: permissible

Stroke length l = 28 mm

Lever arm s = 20 mm

Example 3:

Stroke length l = 150 mm

Lever arm s = 100 mm

$$F_q = \frac{M}{s} = \frac{800 \text{ Nmm}}{100 \text{ mm}}$$

M = max. torque

s = lever arm

Result: permissible

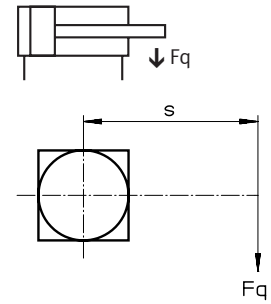
F_q = 8 N < F_{qmax} = 9.5 N

Datasheet

Dimensions

Download CAD data → www.festo.com

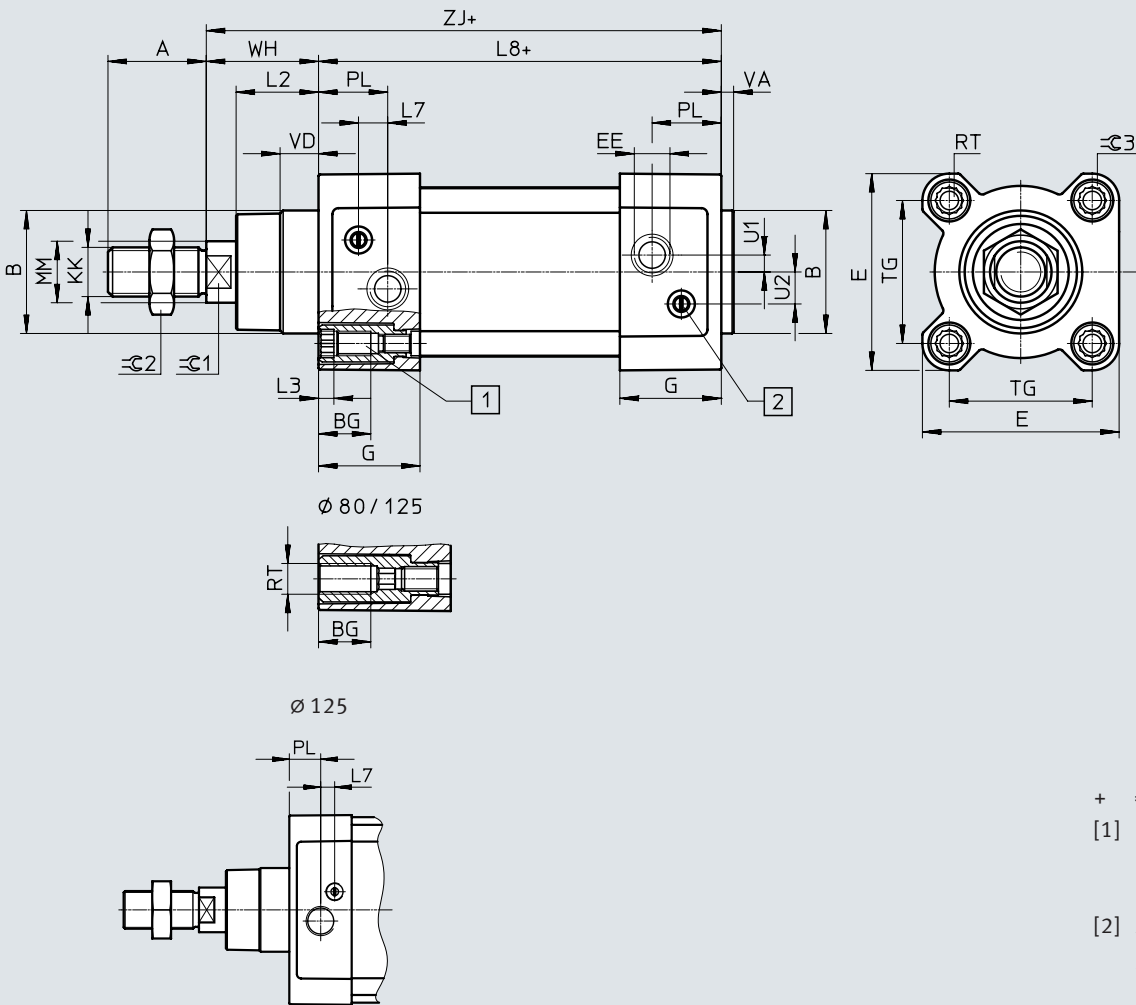

- + = plus stroke length
- [1] Socket head screw with female thread for mounting components
- [2] Adjusting screw for adjustable end-position cushioning (PPV)

Variant

T – Through piston rod

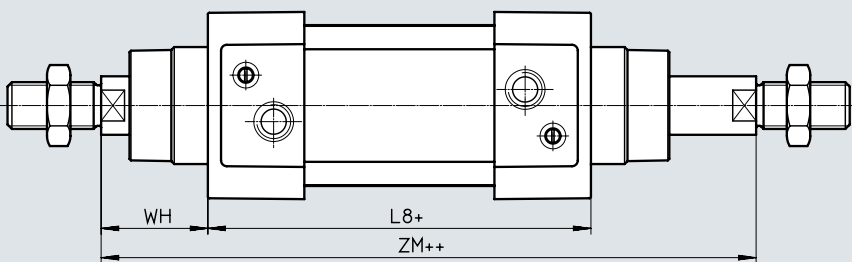

- + = plus stroke length
- ++ = plus 2x stroke length

Datasheet

∅ [mm]	A -0.5	B ∅ d11	BG min.	E +0.5	EE	G -0.2	L2	L3 max.
32	22	30	16	45	G1/8	28	18 _{-0.2}	5
40	24	35	16	54	G1/4	33	21.3 _{-0.2}	5
50	32	40	16	64	G1/4	33	26.8 _{-0.2}	5
63	32	45	16	75	G3/8	40.5	27 _{-0.2}	5
80	40	45	17	93	G3/8	43	34.2 _{-0.2}	-
100	40	55	17	110	G1/2	48	38 _{-0.2}	-
125	54	60	20	136	G1/2	44.7	45 _{-0.3}	-

∅ [mm]	L7	L8 ±0.4	MM ∅	PL ±0.1	RT	TG ±0.3	U1) ±0.1	U2) ±0.1
32	6.5	94	12	19.5	M6	32.5	5.25	5.7
40	7.5	105	16	22.5	M6	38	4	8
50	9.5	106	20	22.5	M8	46.5	5.5	10.4
63	9	121	20	27.5	M8	56.5	6.25	12.75
80	11	128	25	30	M10	72	8	12.5
100	7.5	138	25	31.5	M10	89	10	13.5
125	10	160	32	22.5	M12	110	8	13

∅ [mm]	VA	VD +0.5	WH +2.2	ZJ +1.8	ZM +1	≈C1	≈C2	≈C3
32	4 _{-0.2}	10	25	119.1	146.1	10	17	6
40	4 _{-0.2}	10.5	28.7	133.9	164.8	13	19	6
50	4 _{-0.2}	11.5	35.6	141.8	179.8	17	24	8
63	4 _{-0.2}	15	35.9	157.1	195.4	17	24	8
80	4 _{-0.2}	15.7	45.4	173.6	221	22	30	6
100	4 _{-0.2}	19.2	49.3	187.5	238.8	22	30	6
125	6 _{-0.3}	20.5	64.1	225	290	27	41	8

∅ [mm]	KK	
	DSBG-...	-M... ¹⁾
32	M10x1.25	-
40	M12x1.25	-
50	M16x1.5	-
63	M16x1.5	-
80	M20x1.5	M16/M16x1.5/M20
100	M20x1.5	M16/M16x1.5/M20
125	M27x2	M16/M16x1.5/M20/M20x1.5/M24/M27

1) Threads with a smaller nominal diameter than in the basic version can generally not withstand such high loads. If necessary, the screw connection must be engineered.

Datasheet

Dimensions – Variants

Download CAD data → www.festo.com

Q – With protection against rotation

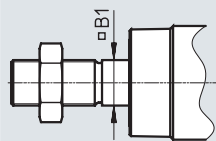

- - **Note**

In combination with variant T, the piston rod is protected against rotation at one end.

F – Female thread

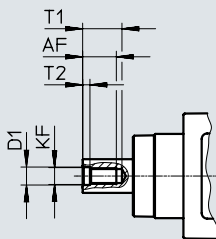

- - **Note**

In combination with variant T, the piston rod has female threads at both ends.

...E – Extended piston rod

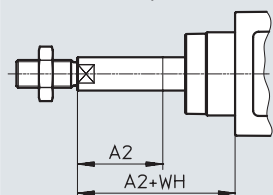

- - **Note**

Piston rod extension at one end in combination with variant T. In combination with variants T and Q, the piston rod is extended only at the square piston rod.

...L – Extended piston rod thread

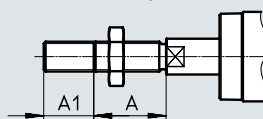

- - **Note**

In combination with variant T, the piston rod thread is extended at both ends.

.....S – Shortened piston rod thread

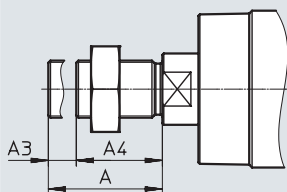

- - **Note**

In combination with variant T, the piston rod thread is shortened at both ends.

Effective thread length: $A4 = A - A3$

∅ [mm]	A	A1		A2		A3	
		min.	max.	min.	max.	min.	max.
32	22	1	35	1	500	–	–
40	24	1	35	1	500	–	–
50	32	1	70	1	500	–	–
63	32	1	70	1	500	–	–
80	40	1	70	1	500	1	30
100	40	1	70	1	500	1	30
125	54	1	70	1	500	1	44

∅ [mm]	AF	B1	D1	KF	T1	T2	WH
	min.				max.		+2.2
32	12	10	6.4	M6	16	2.6	25
40	12	12	8.4	M8	16	3.3	28.7
50	16	16	10.5	M10	21	4.7	35.6
63	16	16	10.5	M10	21	4.7	35.9
80	20	20	13	M12	26.5	6.1	45.4
100	20	20	13	M12	26.5	6.1	49.3
125	32	–	17	M16	40	8	64.1

Datasheet

Dimensions – Variants

Download CAD data → www.festo.com

...V – swivel mounting position

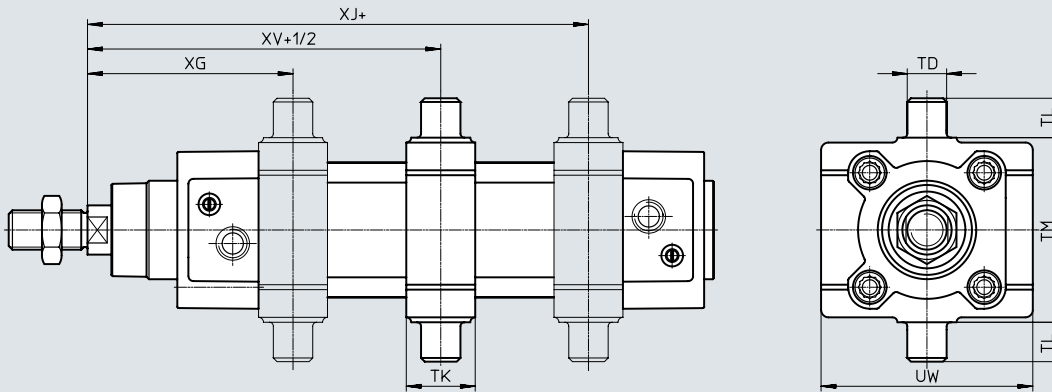

Note

The dimensions for the swivel mounting position (...V) refer to the basic design without piston rod extension.

The swivel mounting can be moved at any time.

+ = plus stroke length
+1/2 = plus half stroke length

∅ [mm]	TD ∅ e9	TK	TL h14	TM h14	UW	XG min.	XJ max.	XV
32	12	20	12	50	65	64±1.4	81±1.4	73±1.4
40	16	25	16	63	72	74.2±1.4	88.4±1.4	81.2±1.4
50	16	28	16	75	86	82.6±1.4	94.8±1.4	88.6±1.4
63	20	30	20	90	98	91.4±1.8	101.6±1.8	96.4±1.8
80	20	32	20	110	110	104.4±1.8	114.6±1.8	109.4±1.8
100	25	38	25	132	136	116.3±1.8	120.5±1.8	118.3±1.8
125	25	44	25	160	160	131.7±1.8	158.3±1.8	145±1.8

...LB2/-LB3 – thread length of spacer bolts

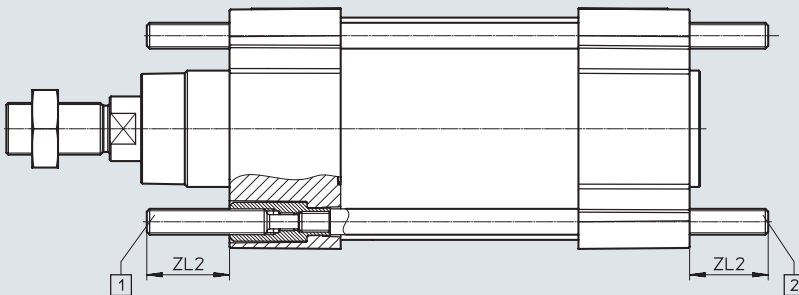

[1] = DSBG-...-LB2
(on bearing cap)
[2] = DSBG-...-LB3
(on end cap)

∅ [mm]	ZL2 ±1
	min. max.
80	20 140
100	20 140
125	24 140

Datasheet

Dimensions – Variants

Download CAD data → www.festo.com

P2 – Protective bellows on the bearing cap

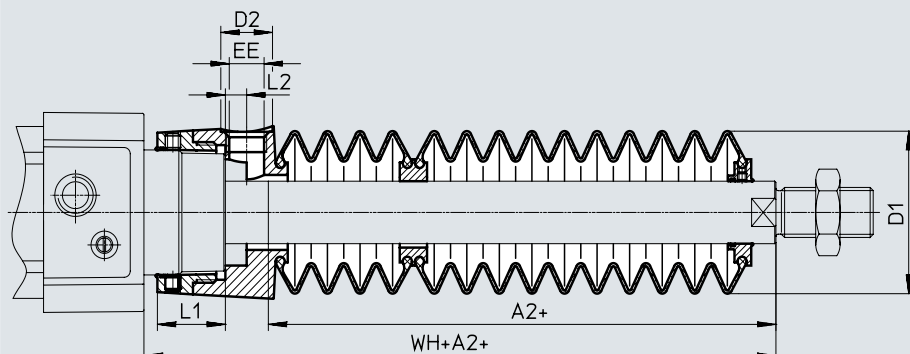

+ = plus stroke length

∅ Stroke [mm]	32							40						
	A2 ¹⁾	D1 max.	D2	EE	L1	L2	WH+A2	A2 ¹⁾	D1 max.	D2	EE	L1	L2	WH+A2
10 ... 50	29	38	14	G1/8	12.9	5.4	55	28	46	14	G1/8	16.3	5.4	56.7
51 ... 125	47						73	43						71.7
126 ... 175	61						87	56						84.7
176 ... 250	80						106	72						100.7
251 ... 300	96						122	86						114.7
301 ... 350	112						138	100						128.7
351 ... 375	114						140	101						129.7
376 ... 425	130						156	115						143.7
426 ... 475	145						171	130						158.7
476 ... 500	147	173	131	159.7										

∅ Stroke [mm]	50							63						
	A2 ¹⁾	D1 max.	D2	EE	L1	L2	WH+A2	A2 ¹⁾	D1 max.	D2	EE	L1	L2	WH+A2
10 ... 50	28	57	17	G1/4	22.35	7	63.6	28	57	17	G1/4	22.4	7	63.9
51 ... 125	46						81.6	46						81.9
126 ... 175	56						91.6	56						91.9
176 ... 250	73						108.6	73						108.9
251 ... 300	86						121.6	86						121.9
301 ... 350	97						132.6	97						132.9
351 ... 375	105						140.6	105						140.9
376 ... 425	116						151.6	116						151.9
426 ... 475	126						161.6	126						161.9
476 ... 500	134	169.6	134	169.9										

∅ Stroke [mm]	80							100						
	A2 ¹⁾	D1 max.	D2	EE	L1	L2	WH+A2	A2 ¹⁾	D1 max.	D2	EE	L1	L2	WH+A2
10 ... 50	25	93	17	G1/4	28	4	70.4	25	93	17	G1/4	28	4	74.3
51 ... 125	37						82.4	37						86.3
126 ... 175	49						94.4	49						98.3
176 ... 250	62						107.4	62						111.3
251 ... 300	74						119.4	74						123.3
301 ... 350	86						131.4	86						135.3
351 ... 375	87						132.4	87						136.3
376 ... 425	98						143.4	98						147.3
426 ... 475	110						155.4	110						159.3
476 ... 500	111	156.4	111	160.3										

1) The dimension corresponds to the E value (piston rod extension) of the drive

Datasheet

Ordering data				With self-adjusting cushioning PPS	
Piston ø [mm]	Stroke [mm]	With end-position cushioning PPV		Part no.	Type
		Part no.	Type		
32	25	1638842	DSBG-32-25-PPVA-N3	1645460	DSBG-32-25-PPSA-N3
	40	1638843	DSBG-32-40-PPVA-N3	1645461	DSBG-32-40-PPSA-N3
	50	1638844	DSBG-32-50-PPVA-N3	1645462	DSBG-32-50-PPSA-N3
	80	1638845	DSBG-32-80-PPVA-N3	1645463	DSBG-32-80-PPSA-N3
	100	1638846	DSBG-32-100-PPVA-N3	1645464	DSBG-32-100-PPSA-N3
	125	1638848	DSBG-32-125-PPVA-N3	1645465	DSBG-32-125-PPSA-N3
	160	1638849	DSBG-32-160-PPVA-N3	1645466	DSBG-32-160-PPSA-N3
	200	1638850	DSBG-32-200-PPVA-N3	1645467	DSBG-32-200-PPSA-N3
	250	1638851	DSBG-32-250-PPVA-N3	1645468	DSBG-32-250-PPSA-N3
	320	1638852	DSBG-32-320-PPVA-N3	1645469	DSBG-32-320-PPSA-N3
	400	1638853	DSBG-32-400-PPVA-N3	1645470	DSBG-32-400-PPSA-N3
	500	1638854	DSBG-32-500-PPVA-N3	1645471	DSBG-32-500-PPSA-N3
	1 ... 2800	1634781	DSBG-32-...-PPVA-N3	1634560	DSBG-32-...-PPSA-N3
40	25	1646547	DSBG-40-25-PPVA-N3	1646559	DSBG-40-25-PPSA-N3
	40	1646548	DSBG-40-40-PPVA-N3	1646560	DSBG-40-40-PPSA-N3
	50	1646549	DSBG-40-50-PPVA-N3	1646561	DSBG-40-50-PPSA-N3
	80	1646550	DSBG-40-80-PPVA-N3	1646562	DSBG-40-80-PPSA-N3
	100	1646551	DSBG-40-100-PPVA-N3	1646563	DSBG-40-100-PPSA-N3
	125	1646552	DSBG-40-125-PPVA-N3	1646564	DSBG-40-125-PPSA-N3
	160	1646553	DSBG-40-160-PPVA-N3	1646565	DSBG-40-160-PPSA-N3
	200	1646554	DSBG-40-200-PPVA-N3	1646566	DSBG-40-200-PPSA-N3
	250	1646555	DSBG-40-250-PPVA-N3	1646567	DSBG-40-250-PPSA-N3
	320	1646556	DSBG-40-320-PPVA-N3	1646568	DSBG-40-320-PPSA-N3
	400	1646557	DSBG-40-400-PPVA-N3	1646569	DSBG-40-400-PPSA-N3
	500	1646558	DSBG-40-500-PPVA-N3	1646570	DSBG-40-500-PPSA-N3
	1 ... 2800	1644503	DSBG-40-...-PPVA-N3	1645473	DSBG-40-...-PPSA-N3
50	25	1646709	DSBG-50-25-PPVA-N3	1646723	DSBG-50-25-PPSA-N3
	40	1646710	DSBG-50-40-PPVA-N3	1646724	DSBG-50-40-PPSA-N3
	50	1646711	DSBG-50-50-PPVA-N3	1646725	DSBG-50-50-PPSA-N3
	80	1646712	DSBG-50-80-PPVA-N3	1646726	DSBG-50-80-PPSA-N3
	100	1646713	DSBG-50-100-PPVA-N3	1646727	DSBG-50-100-PPSA-N3
	125	1646714	DSBG-50-125-PPVA-N3	1646728	DSBG-50-125-PPSA-N3
	160	1646715	DSBG-50-160-PPVA-N3	1646729	DSBG-50-160-PPSA-N3
	200	1646716	DSBG-50-200-PPVA-N3	1646730	DSBG-50-200-PPSA-N3
	250	1646717	DSBG-50-250-PPVA-N3	1646731	DSBG-50-250-PPSA-N3
	320	1646718	DSBG-50-320-PPVA-N3	1646732	DSBG-50-320-PPSA-N3
	400	1646719	DSBG-50-400-PPVA-N3	1646733	DSBG-50-400-PPSA-N3
	500	1646720	DSBG-50-500-PPVA-N3	1646734	DSBG-50-500-PPSA-N3
	1 ... 2800	1646708	DSBG-50-...-PPVA-N3	1646722	DSBG-50-...-PPSA-N3

 Note

Other variants in the modular product system → page 24

Datasheet

Ordering data				With self-adjusting cushioning PPS	
Piston ø [mm]	Stroke [mm]	With end-position cushioning PPV		Part no.	Type
		Part no.	Type		
63	25	1646740	DSBG-63-25-PPVA-N3	1646754	DSBG-63-25-PPSA-N3
	40	1646741	DSBG-63-40-PPVA-N3	1646755	DSBG-63-40-PPSA-N3
	50	1646742	DSBG-63-50-PPVA-N3	1646756	DSBG-63-50-PPSA-N3
	80	1646743	DSBG-63-80-PPVA-N3	1646757	DSBG-63-80-PPSA-N3
	100	1646744	DSBG-63-100-PPVA-N3	1646758	DSBG-63-100-PPSA-N3
	125	1646745	DSBG-63-125-PPVA-N3	1646760	DSBG-63-125-PPSA-N3
	160	1646746	DSBG-63-160-PPVA-N3	1646761	DSBG-63-160-PPSA-N3
	200	1646747	DSBG-63-200-PPVA-N3	1646762	DSBG-63-200-PPSA-N3
	250	1646748	DSBG-63-250-PPVA-N3	1646763	DSBG-63-250-PPSA-N3
	320	1646749	DSBG-63-320-PPVA-N3	1646764	DSBG-63-320-PPSA-N3
	400	1646750	DSBG-63-400-PPVA-N3	1646765	DSBG-63-400-PPSA-N3
	500	1646751	DSBG-63-500-PPVA-N3	1646766	DSBG-63-500-PPSA-N3
	1 ... 2800	1646739	DSBG-63-...-PPVA-N3	1646753	DSBG-63-...-PPSA-N3
	80	25	1646771	DSBG-80-25-PPVA-N3	1646785
40		1646772	DSBG-80-40-PPVA-N3	1646786	DSBG-80-40-PPSA-N3
50		1646773	DSBG-80-50-PPVA-N3	1646787	DSBG-80-50-PPSA-N3
80		1646774	DSBG-80-80-PPVA-N3	1646788	DSBG-80-80-PPSA-N3
100		1646775	DSBG-80-100-PPVA-N3	1646789	DSBG-80-100-PPSA-N3
125		1646776	DSBG-80-125-PPVA-N3	1646790	DSBG-80-125-PPSA-N3
160		1646777	DSBG-80-160-PPVA-N3	1646791	DSBG-80-160-PPSA-N3
200		1646778	DSBG-80-200-PPVA-N3	1646792	DSBG-80-200-PPSA-N3
250		1646779	DSBG-80-250-PPVA-N3	1646793	DSBG-80-250-PPSA-N3
320		1646780	DSBG-80-320-PPVA-N3	1646794	DSBG-80-320-PPSA-N3
400		1646781	DSBG-80-400-PPVA-N3	1646795	DSBG-80-400-PPSA-N3
500		1646782	DSBG-80-500-PPVA-N3	1646796	DSBG-80-500-PPSA-N3
1 ... 2800		1646770	DSBG-80-...-PPVA-N3	1646784	DSBG-80-...-PPSA-N3
100		25	1646801	DSBG-100-25-PPVA-N3	1646815
	40	1646802	DSBG-100-40-PPVA-N3	1646816	DSBG-100-40-PPSA-N3
	50	1646803	DSBG-100-50-PPVA-N3	1646817	DSBG-100-50-PPSA-N3
	80	1646804	DSBG-100-80-PPVA-N3	1646818	DSBG-100-80-PPSA-N3
	100	1646805	DSBG-100-100-PPVA-N3	1646819	DSBG-100-100-PPSA-N3
	125	1646806	DSBG-100-125-PPVA-N3	1646820	DSBG-100-125-PPSA-N3
	160	1646807	DSBG-100-160-PPVA-N3	1646821	DSBG-100-160-PPSA-N3
	200	1646808	DSBG-100-200-PPVA-N3	1646822	DSBG-100-200-PPSA-N3
	250	1646809	DSBG-100-250-PPVA-N3	1646823	DSBG-100-250-PPSA-N3
	320	1646810	DSBG-100-320-PPVA-N3	1646824	DSBG-100-320-PPSA-N3
	400	1646811	DSBG-100-400-PPVA-N3	1646825	DSBG-100-400-PPSA-N3
	500	1646812	DSBG-100-500-PPVA-N3	1646826	DSBG-100-500-PPSA-N3
	1 ... 2800	1646800	DSBG-100-...-PPVA-N3	1646814	DSBG-100-...-PPSA-N3

 Note

Other variants in the modular product system → page 24

Datasheet

Ordering data					
Piston ø [mm]	Stroke [mm]	With end-position cushioning PPV		With self-adjusting cushioning PPS	
		Part no.	Type	Part no.	Type
125	25	2159622	DSBG-125-25-PPVA-N3	2159907	DSBG-125-25-PPSA-N3
	40	2159623	DSBG-125-40-PPVA-N3	2159908	DSBG-125-40-PPSA-N3
	50	2159624	DSBG-125-50-PPVA-N3	2159909	DSBG-125-50-PPSA-N3
	80	2159625	DSBG-125-80-PPVA-N3	2159910	DSBG-125-80-PPSA-N3
	100	2159626	DSBG-125-100-PPVA-N3	2159911	DSBG-125-100-PPSA-N3
	125	2159627	DSBG-125-125-PPVA-N3	2159912	DSBG-125-125-PPSA-N3
	160	2159628	DSBG-125-160-PPVA-N3	2159913	DSBG-125-160-PPSA-N3
	200	2159629	DSBG-125-200-PPVA-N3	2159915	DSBG-125-200-PPSA-N3
	250	2159630	DSBG-125-250-PPVA-N3	2159916	DSBG-125-250-PPSA-N3
	320	2159631	DSBG-125-320-PPVA-N3	2159917	DSBG-125-320-PPSA-N3
	400	2159632	DSBG-125-400-PPVA-N3	2159918	DSBG-125-400-PPSA-N3
	500	2159633	DSBG-125-500-PPVA-N3	2159919	DSBG-125-500-PPSA-N3
	1 ... 2800	2158455	DSBG-125-...-PPVA-N3	2158471	DSBG-125-...-PPSA-N3

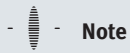
**Note**

Other variants in the modular product system → page 24

Ordering data – Modular product system

Ordering table											
Size	32	40	50	63	80	100	125	Condi- tions	Code	Enter code	
Module no.	1634484	1645477	1646707	1646738	1646769	1646799	2045493				
Function	Standards-based cylinder, double-acting, based on ISO 15552								DSBG	DSBG	
Protection against rotation	Without										
	With protection against rotation							–	[1]	-Q	
Running characteristics	Standard										
	Low friction							–	[2]	L	
	Constant, slow movement								[2]	U	
	Low friction for balancer applications								[3]	L1	
Piston ø [mm]	32	40	50	63	80	100	125		-...		
Stroke [mm]	1 ... 2800								-...		
Piston rod type	On one side										
	Through piston rod									-T	
Piston rod thread type	Male thread										
	Female thread								[4]	F	
Cushioning	Elastic cushioning rings/plates at both ends									-P	
	Pneumatic cushioning, self-adjusting at both ends								[5]	-PPS	
	Pneumatic cushioning, adjustable at both ends									-PPV	
Position sensing	Via proximity switch									A	A
Standard	Based on ISO 15552										
	Conforms to ISO 15552									-N3	
Corrosion protection	Standard										
	High corrosion protection								[6]	R3	
Temperature range	Standard										
	[°C]	Heat-resistant seals up to max. 120								[7]	T1
	[°C]	–40 ... +80								[7]	T3
	[°C]	0 ... +150								[7]	T4

[1] Q Not with L, U, N3, T3, T4, P2, A2, A3, A6
Only up to stroke of 1500 mm

[2] L, U Not with T, R3, T1, T3, T4, P2, A2, A3, A6, EX4

[3] L1 Not with T, PPV, R3, T1, T3, T4, P2, A2, A3, A6, EX4

[4] F Not with N3, ...L, M...

[5] PPS Not with T1, T3, T4

[6] R3 Not with A2, A6, ...V

[7] T1, T3, T4 Not with P2, A2, A3, EX4

 - **Note**

If characteristic L is used in combination with transverse loads or strokes of above 500 mm, suitable measures must be taken to support the piston rod.

The operating pressure (→ page 10) is applicable for strokes up to 500 mm.

 - **Note**

If characteristic L1 is used in combination with strokes of above 500 mm, suitable measures must be taken to support the piston rod.

The operating pressure (→ page 10) is applicable for strokes up to 500 mm.

Ordering data – Modular product system

Ordering table											
Size	32	40	50	63	80	100	125	Condi- tions	Code	Enter code	
Protection against particles	Standard										
	Protective bellows on bearing cap							–	[8]	P2	
Wiper variant	None										
	Hard wiper									A2	
	For unlubricated operation									A3	
	Metal scraper									A6	
EU certification	None										
	II 2GD								[9]	EX4	
Swivel mounting position [mm]	Without										
	0 ... 2800									-...V	
Piston rod extension [mm]	Without										
	1 ... 500								[10]	-...E	
Extended piston rod thread [mm]	Without										
	1 ... 35		1 ... 70						[10]	-...L	
Shortened piston rod thread [mm]	Without										
	–				1 ... 30		1 ... 44			-...S	
Piston rod thread	Standard (→ 17)										
	–				M16			[11]	-M16		
	–				M16x1.5			[11]	-M16P		
	–				M20			[11]	-M20		
	–				M20x1.5		[11]	-M20P			
	–				M24		[11]	-M24			
–				M27			[11]	-M27			
Thread length [mm]	Without										
	–				On bearing cap			[11]	-...LB2		
Spacer bolt	–				20 ... 140		24 ... 140		[11]	-...LB3	
	–				On the end cap		[11]	-...LB3			
–				20 ... 140		24 ... 140					

[8] P2 Not with N3, A2, A3, A6, EX4
Only for strokes 10 ... 500 mm

[9] EX4 Not with T1, T3, T4, P2, A3, A6, ...LB2, ...LB3

[10] ...E, ...L Only up to stroke of 2000 mm.
Not with N3

[11] M..., LB... Not with N3

 **Note**

The piston rod extension for the bellows is automatically taken into consideration when characteristic P2 is selected. This means that there is no need to specify a value for characteristic ...E.

 **Note**

When feature ...E is selected in combination with feature P2, the part of the piston rod extension ...E is not covered by the protective bellows.

 **Note**

When feature P2 is selected in combination with feature T (through piston rod), the protective bellows is mounted at one end only.

 **Note**

If a thread smaller than the standard thread is selected for characteristic M... (piston rod thread), this may reduce the load capacity.

 **Note**

If feature M... is selected, the scope of delivery does not include the piston rod nut.

Accessories

Foot mounting HNC/CRHNC

Material:

HNC: Galvanised steel

CRHNC: High-alloy steel

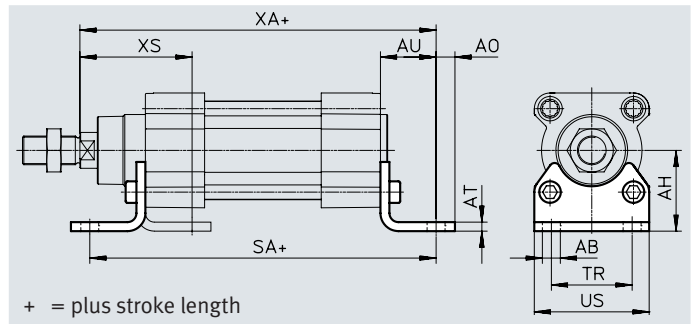

Dimensions and ordering data

For \varnothing [mm]	AB \varnothing	AH	AO	AT	AU	SA	TR	US	XA	XS
32	7	32	6.5	4	24	142	32	45	143.1	46
40	10	36	9	4	28	161	36	54	161.9	52.7
50	10	45	9.5	5	32	170	45	64	173.8	62.6
63	10	50	12.5	5	32	185	50	75	189.1	62.9
80	12	63	15	6	41	210	63	93	214.6	80.4
100	14.5	71	17.5	6	41	220	75	110	228.5	84.3
125	16.5	90	22	8	45	250	90	131	270	102

For \varnothing [mm]	Basic version				Corrosion resistant			
	CRC ¹⁾	Weight [g]	Part no.	Type ²⁾	CRC ¹⁾	Weight [g]	Part no.	Type ²⁾
32	2	144	174369	HNC-32	4	139	176937	CRHNC-32
40	2	193	174370	HNC-40	4	188	176938	CRHNC-40
50	2	353	174371	HNC-50	4	341	176939	CRHNC-50
63	2	436	174372	HNC-63	4	424	176940	CRHNC-63
80	2	829	174373	HNC-80	4	809	176941	CRHNC-80
100	2	1009	174374	HNC-100	4	990	176942	CRHNC-100
125	2	1902	174375	HNC-125	4	1920	176943	CRHNC-125

1) More information www.festo.com/x/topic/crc

2) Suitable for ATEX

Accessories

Flange mounting FNC/CRFNG

Material:

FNC: Galvanised steel

CRFNG: high-alloy steel

RoHS-compliant

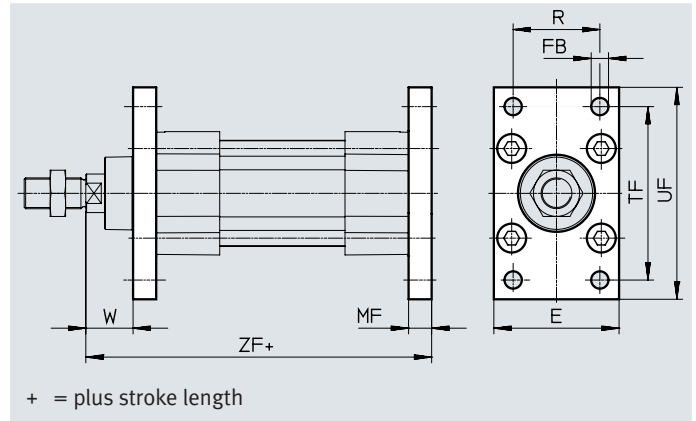
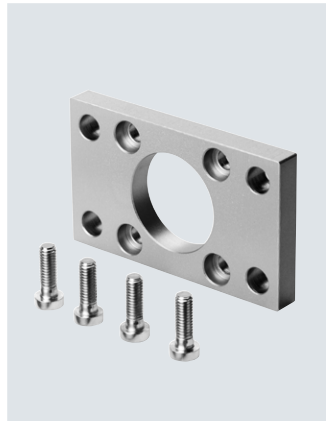

+ = plus stroke length

Dimensions and ordering data								
For \varnothing	E	FB \varnothing H13	MF	R	TF	UF	W	ZF
[mm]								
32	45	7	10	32	64	80	16	129.1
40	54	9	10	36	72	90	18.7	143.9
50	65	9	12	45	90	110	23.6	153.8
63	75	9	12	50	100	120	23.9	169.1
80	93	12	16	63	126	150	29.4	189.6
100	110	14	16	75	150	175	33.3	203.5
125	132	16	20	90	180	210	45	245

For \varnothing	Basic version				Corrosion resistant			
	CRC ¹⁾	Weight [g]	Part no.	Type ²⁾	CRC ¹⁾	Weight [g]	Part no.	Type ²⁾
[mm]								
32	1	221	174376	FNC-32	4	220	161846	CRFNG-32
40	1	291	174377	FNC-40	4	291	161847	CRFNG-40
50	1	536	174378	FNC-50	4	526	161848	CRFNG-50
63	1	679	174379	FNC-63	4	680	161849	CRFNG-63
80	1	1495	174380	FNC-80	4	1508	161850	CRFNG-80
100	1	2041	174381	FNC-100	4	2054	161851	CRFNG-100
125	1	3775	174382	FNC-125	4	3787	185363	CRFNG-125

1) More information www.festo.com/x/topic/crc

2) Suitable for ATEX

Accessories

Trunnion flange ZNCF/CRZNG

Material:

ZNCF: Stainless steel casting

CRZNG: Electropolished stainless steel casting

RoHS-compliant

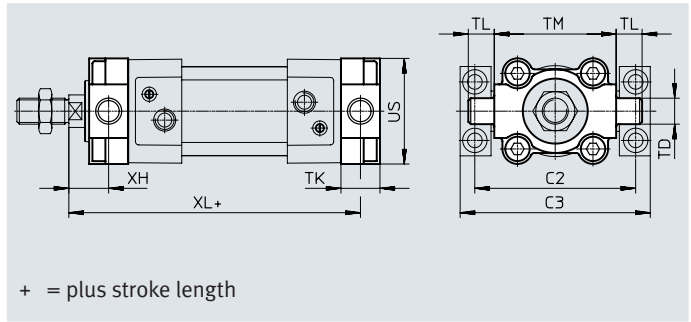
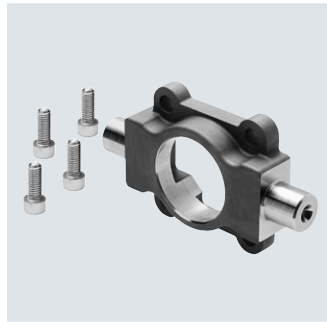

Dimensions and ordering data

For \varnothing [mm]	C2)	C3)	TD \varnothing e9	TK	TL	TM	US	XH	XL
32	71	86	12	16	12	50	45	18	127.1
40	87	105	16	20	16	63	54	18.7	143.9
50	99	117	16	24	16	75	64	23.6	153.8
63	116	136	20	24	20	90	75	23.9	169.1
80	136	156	20	28	20	110	93	31.4	187.6
100	164	189	25	38	25	132	110	30.3	206.5
125	192	217	25	50	25	160	131	40	250

For \varnothing [mm]	Basic version				Corrosion resistant			
	CRC ¹⁾	Weight [g]	Part no.	Type ²⁾	CRC ¹⁾	Weight [g]	Part no.	Type ²⁾
32	2	150	174411	ZNCF-32	4	150	161852	CRZNG-32
40	2	285	174412	ZNCF-40	4	285	161853	CRZNG-40
50	2	473	174413	ZNCF-50	4	473	161854	CRZNG-50
63	2	687	174414	ZNCF-63	4	687	161855	CRZNG-63
80	2	1296	174415	ZNCF-80	4	1296	161856	CRZNG-80
100	2	2254	174416	ZNCF-100	4	2254	161857	CRZNG-100
125	2	3484	174417	ZNCF-125	4	3484	185362	CRZNG-125

1) More information www.festo.com/x/topic/crc

2) Suitable for ATEX

Accessories

Trunnion support LNZG

Material:
Trunnion support: Anodised aluminium
Plain bearing: Plastic
RoHS-compliant

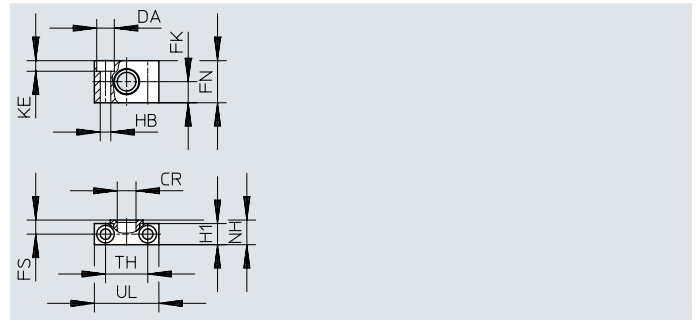
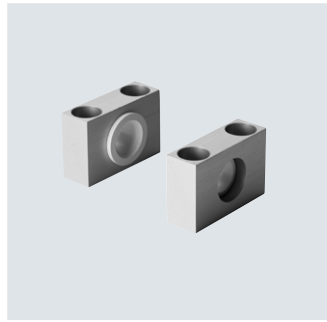

Dimensions and ordering data

For \varnothing [mm]	CR \varnothing D11	DA \varnothing H13	FK \varnothing ± 0.1	FN	FS	H1	HB \varnothing H13	KE	NH	TH ± 0.2	UL	CRC ¹⁾	Weight [g]	Part no.	Type
32	12	11	15	30	10.5	15	6.6	6.8	18	32	46	2	83	32959	LNZG-32
40, 50	16	15	18	36	12	18	9	9	21	36	55	2	129	32960	LNZG-4 0/50
63, 80	20	18	20	40	13	20	11	11	23	42	65	2	178	32961	LNZG-6 3/80
100, 125	25	20	25	50	16	24.5	14	13	28.5	50	75	2	306	32962	LNZG-10 0/125

1) More information: www.festo.com/x/topic/crc

Trunnion support CRLNZG

Material:
High-alloy steel
RoHS-compliant

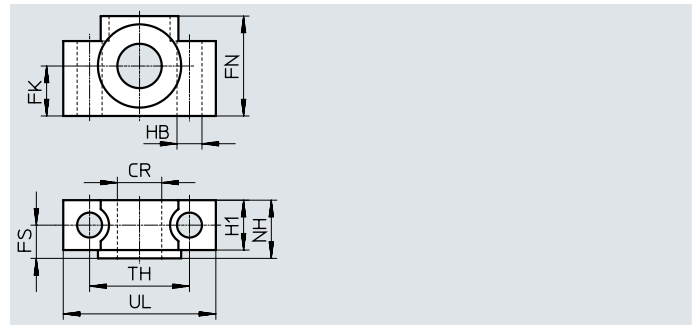
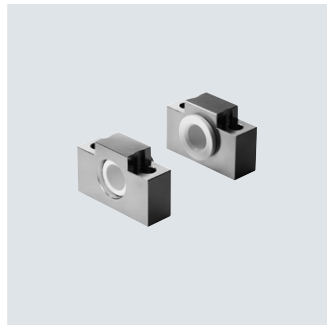

Dimensions and ordering data

For \varnothing [mm]	CR \varnothing D11	FK \varnothing ± 0.1	FN	FS	H1	HB \varnothing H13	NH	TH ± 0.2	UL	CRC ¹⁾	Weight [g]	Part no.	Type
32	12	15	30	10.5	15	6.6	18	32	46	4	205	161874	CRLNZG-32
40, 50	16	18	36	12	18	9	21	36	55	4	323	161875	CRLNZG-4 0/50
63, 80	20	20	40	13	20	11	23	42	65	4	435	161876	CRLNZG-6 3/80
100, 125	25	25	50	16	24.5	14	28.5	50	75	4	739	161877	CRLNZG-10 0/125

1) More information: www.festo.com/x/topic/crc

Accessories

Swivel flange SNC

Material:
Die-cast aluminium
RoHS-compliant

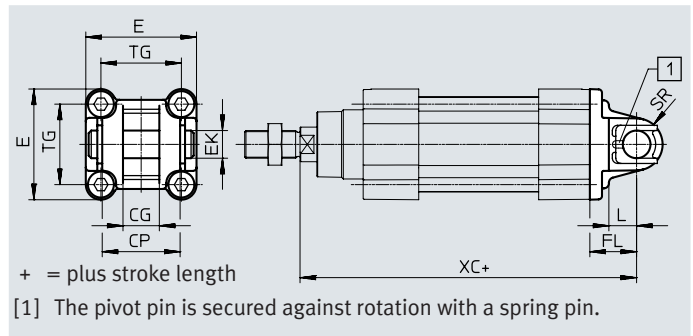
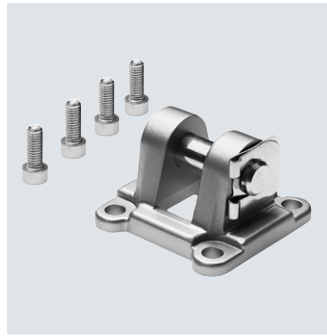

Dimensions and ordering data

For \varnothing	CG	CP	E	EK \varnothing	FL	L	SR	TG	XC	CRC ¹⁾	Weight	Part no.	Type ²⁾
[mm]	H14	h14		H9	± 0.2						[g]		
32	14	34	$45_{+0.2/-0.5}$	10	22	13	10	32.5	141.1	1	93	174383	SNC-32
40	16	40	$54_{-0.5}$	12	25	16	12	38	158.9	1	140	174384	SNC-40
50	21	45	$64_{-0.6}$	16	27	16	12	46.5	168.8	1	234	174385	SNC-50
63	21	51	$75_{-0.6}$	16	32	21	16	56.5	189.1	1	331	174386	SNC-63
80	25	65	$93_{-0.8}$	20	36	22	16	72	209.6	1	618	174387	SNC-80
100	25	75	$110_{+0.3/-0.8}$	20	41	27	20	89	228.5	1	865	174388	SNC-100
125	37	97	$131_{-0.8}$	30	50	30	25	110	275	1	1728	174389	SNC-125

1) More information www.festo.com/x/topic/crc

2) Suitable for ATEX

Accessories

Swivel flange SNCB/SNCB-...-R3

Material:
 SNCB: Die-cast aluminium
 SNCB-...-R3: Die-cast aluminium
 with protective coating
 RoHS-compliant

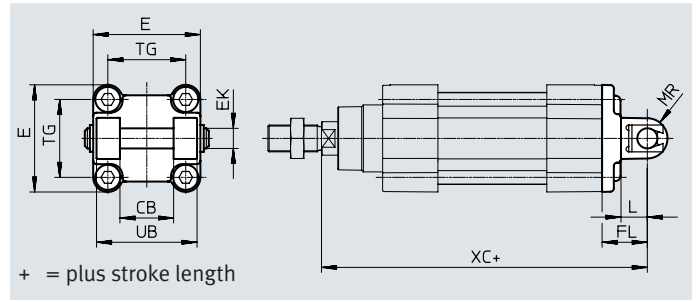
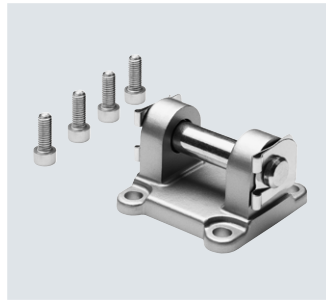

Dimensions and ordering data									
For \varnothing	CB	E	EK \varnothing	FL	L	MR	TG	UB	XC
[mm]	H14		H9/e8	± 0.2		-0.5		h14	
32	26	45 $^{+0.2/-0.5}$	10	22	13	8.5	32.5	45	141.1
40	28	54 $_{-0.5}$	12	25	16	12	38	52	158.9
50	32	64 $_{-0.6}$	12	27	16	12	46.5	60	168.8
63	40	75 $_{-0.6}$	16	32	21	16	56.5	70	189.1
80	50	93 $_{-0.8}$	16	36	22	16	72	90	209.6
100	60	110 $^{+0.3/-0.8}$	20	41	27	20	89	110	228.5
125	70	131 $_{-0.8}$	25	50	30	25	110	130	275

For \varnothing	Basic version				R3 – High corrosion protection			
	CRC ¹⁾	Weight [g]	Part no.	Type	CRC ¹⁾	Weight [g]	Part no.	Type
[mm]								
32	1	103	174390	SNCB-32	3	100	176944	SNCB-32-R3
40	1	155	174391	SNCB-40	3	151	176945	SNCB-40-R3
50	1	232	174392	SNCB-50	3	228	176946	SNCB-50-R3
63	1	375	174393	SNCB-63	3	371	176947	SNCB-63-R3
80	1	636	174394	SNCB-80	3	632	176948	SNCB-80-R3
100	1	1035	174395	SNCB-100	3	986	176949	SNCB-100-R3
125	1	1860	174396	SNCB-125	3	1776	176950	SNCB-125-R3

1) More information: www.festo.com/x/topic/crc

Accessories

Swivel flange SNCS/CRSNCS/SNCS-...-R3

Material:
 SNCS 32 ... 50:
 Die-cast aluminium
 SNCS 63 ... 125:
 Wrought aluminium alloy
 CRSNCS 32 ... 80:
 High-alloy stainless steel
 SNCS-...-R3 100 ... 125:
 Wrought aluminium alloy with
 protective coating
 RoHS-compliant

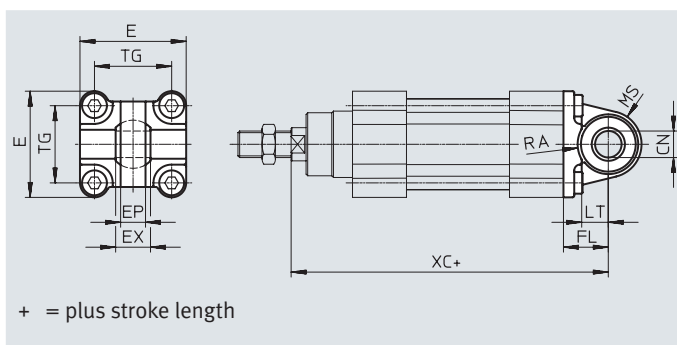

Dimensions and ordering data

For \varnothing [mm]	CN \varnothing		E		EP ± 0.2	EX	FL ± 0.2
	DSBG-...	DSBG-...-R3	DSBG-...	DSBG-...-R3			
32	10 ^{+0.013}	10+0.015/-0.04	45+0.2/-0.5	45-0.5	10.5	14	22
40	12 ^{+0.015}	12+0.018/-0.04	54 _{-0.5}	54 _{-0.5}	12	16	25
50	16 ^{+0.015}	16+0.018/-0.04	64 _{-0.6}	64 _{-0.6}	15	21	27
63	16 ^{+0.015}	16+0.018/-0.04	74.5 ± 0.5	75 _{-0.6}	15	21	32
80	20 ^{+0.018}	20+0.021/-0.04	92.2 ± 0.8	93 _{-0.8}	18	25	36
100	20 ^{+0.018}	20+0.021/-0.04	109+1/-0.7	109+1/-0.7	18	25	41
125	30 ^{+0.018}	30+0.021/-0.04	132+1/-0.7	132+1/-0.7	25	37	50

For \varnothing [mm]	LT	MS		RA		TG	XC
		DSBG	DSBG-...-R3	DSBG +1	DSBG-...-R3 +1		
32	13	15 ^{+0.5}	15 ^{+0.5}	14.5	14.5	32.5	141.1
40	16	17 ^{+0.5}	17 ^{+0.5}	17.5	17.5	38	158.9
50	16	20 ^{+0.5}	20 ^{+0.5}	18.5	19	46.5	168.8
63	21	23 _{-0.5}	22 ^{+0.5}	23	23	56.5	189.1
80	22	28 _{-0.5}	27 ^{+0.5}	25	25	72	209.6
100	27	30 ± 0.5	30 ± 0.5	95	100	89	228.5
125	30	39 ± 0.5	39 ± 0.5	100	100	110	275

For \varnothing [mm]	Basic version				High corrosion protection			
	CRC ¹⁾	Weight [g]	Part no.	Type	CRC ¹⁾	Weight [g]	Part no.	Type
32	1	86	174397	SNCS-32	4	161	2895920	CRSNCS-32
40	1	122	174398	SNCS-40	4	239	2895921	CRSNCS-40
50	1	216	174399	SNCS-50	4	403	2895922	CRSNCS-50
63	2	281	174400	SNCS-63	4	576	2895923	CRSNCS-63
80	2	557	174401	SNCS-80	4	1173	2895924	CRSNCS-80
100	2	683	174402	SNCS-100	3	684	2895925	SNCS-100-R3
125	2	1369	174403	SNCS-125	3	1369	2895926	SNCS-125-R3

1) More information: www.festo.com/x/topic/crc

Accessories

Swivel flange SNCL

Material:
Die-cast aluminium
RoHS-compliant

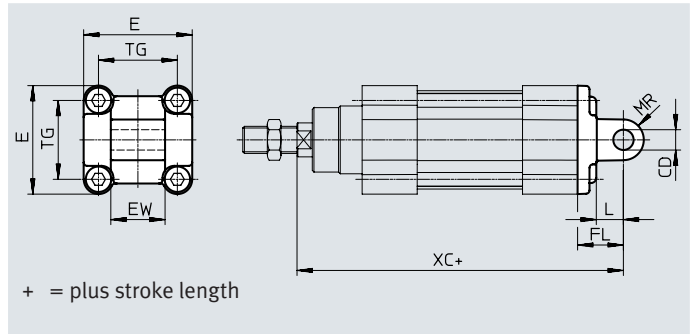

Dimensions and ordering data



For \varnothing [mm]	CD \varnothing H9	E	EW h12	FL ± 0.2	L	MR	TG	XC	CRC ¹⁾	Weight [g]	Part no.	Type
32	10	45 ^{+0.2/-0.5}	26	22	13	10	32.5	141.1	1	71	174404	SNCL-32
40	12	54 ^{-0.5}	28	25	16	12	38	158.9	1	95	174405	SNCL-40
50	12	64 ^{-0.6}	32	27	16	12	46.5	168.8	1	158	174406	SNCL-50
63	16	75 ^{-0.6}	40	32	21	16	56.5	189.1	1	225	174407	SNCL-63
80	16	93 ^{-0.8}	50	36	22	16	72	209.6	1	436	174408	SNCL-80
100	20	110 ^{+0.3/-0.8}	60	41	27	20	89	228.5	1	606	174409	SNCL-100
125	25	131 ^{-0.8}	70	50	30	25	110	275	1	1135	174410	SNCL-125



1) More information: www.festo.com/x/topic/crc

Accessories

Ordering data – Mounting components

Datasheets → Internet: clevis foot

Designation	For ø	Part no.	Type
Clevis foot LNG			
	32	33890	LNG-32
	40	33891	LNG-40
	50	33892	LNG-50
	63	33893	LNG-63
	80	33894	LNG-80
	100	33895	LNG-100
	125	33896	LNG-125
Clevis foot LSNG			
	32	31740	LSNG-32
	40	31741	LSNG-40
	50	31742	LSNG-50
	63	31743	LSNG-63
	80	31744	LSNG-80
	100	31745	LSNG-100
	125	31746	LSNG-125
Clevis foot LBG¹⁾			
	32	31761	LBG-32
	40	31762	LBG-40
	50	31763	LBG-50
	63	31764	LBG-63
	80	31765	LBG-80
	100	31766	LBG-100
	125	31767	LBG-125

Designation	For ø	Part no.	Type
Clevis foot LSN			
	32	5561	LSN-32
	40	5562	LSN-40
	50	5563	LSN-50
	63	5564	LSN-63
	80	5565	LSN-80
	100	5566	LSN-100
	125	6987	LSN-125
Clevis foot LSNSG			
	32	31747	LSNSG-32
	40	31748	LSNSG-40
	50	31749	LSNSG-50
	63	31750	LSNSG-63
	80	31751	LSNSG-80
	100	31752	LSNSG-100
	125	31753	LSNSG-125
Right-angle clevis foot LQG¹⁾			
	32	31768	LQG-32
	40	31769	LQG-40
	50	31770	LQG-50
	63	31771	LQG-63
	80	31772	LQG-80
	100	31773	LQG-100
	125	31774	LQG-125

1) Suitable for ATEX

Ordering data – Mounting components, corrosion-resistant

Datasheets → Internet: crlng

Designation	For ø	Part no.	Type
Clevis foot CRLNG			
	32	161840	CRLNG-32
	40	161841	CRLNG-40
	50	161842	CRLNG-50
	63	161843	CRLNG-63
	80	161844	CRLNG-80
	100	161845	CRLNG-100
	125	176951	CRLNG-125

Ordering data – Mounting components, high corrosion protection

Datasheets → Internet: clevis foot

Designation	For ø	Part no.	Type
Clevis foot LBG-R3			
	32	2078790	LBG-32-R3
	40	2078792	LBG-40-R3
	50	2078794	LBG-50-R3
	63	2078795	LBG-63-R3
	80	2078797	LBG-80-R3
	100	2078799	LBG-100-R3
	125	2078837	LBG-125-R3

Accessories

Ordering data – Piston rod attachments

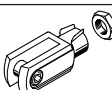
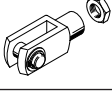
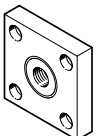
Designation	For ø	Part no.	Type
Rod eye SGS			
	32	9261	SGS-M10x1.25
	40	9262	SGS-M12x1.25
	50	9263	SGS-M16x1.5
	63		
	80	9264	SGS-M20x1.5
	100		
	125	10774	SGS-M27x2
Rod clevis SG¹⁾			
	32	6144	SG-M10x1.25
	40	6145	SG-M12x1.25
	50	6146	SG-M16x1.5
	63		
	80	6147	SG-M20x1.5
	100		
	125	14987	SG-M27x2-B
Coupling piece KSG¹⁾			
	32	32963	KSG-M10x1.25
	40	32964	KSG-M12x1.25
	50	32965	KSG-M16x1.5
	63		
	80	32966	KSG-M20x1.5
	100		
	125	32967	KSG-M27x2

1) Suitable for ATEX

Datasheets → Internet: piston rod attachment

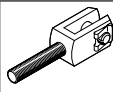
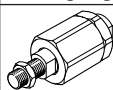
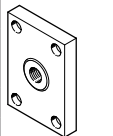
Designation	For ø	Part no.	Type
Rod clevis SGA¹⁾			
	32	32954	SGA-M10x1.25
	40	10767	SGA-M12x1.25
	50	10768	SGA-M16x1.5
	63		
	80	10769	SGA-M20x1.5
	100		
	125	10770	SGA-M27x2
Self-aligning rod coupler FK¹⁾			
	32	6140	FK-M10x1.25
	40	6141	FK-M12x1.25
	50	6142	FK-M16x1.5
	63		
	80	6143	FK-M20x1.5
	100		
	125	10485	FK-M27x2
Coupling piece KSZ¹⁾			
	32	36125	KSZ-M10x1.25
	40	36126	KSZ-M12x1.25
	50	36127	KSZ-M16x1.5
	63		
	80	36128	KSZ-M20x1.5
	100		
	125	-	-

Ordering data – Piston-rod attachments, corrosion-resistant

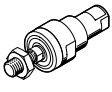
Designation	For ø	Part no.	Type
Rod eye CRSGS			
	32	195582	CRSGS-M10x1.25
	40	195583	CRSGS-M12x1.25
	50	195584	CRSGS-M16x1.5
	63		
	80	195585	CRSGS-M20x1.5
	100		
	125	195586	CRSGS-M27x2
Self-aligning rod coupler CRFK¹⁾			
	32	2305778	CRFK-M10x1.25
	40	2305779	CRFK-M12x1.25
	50	2490673	CRFK-M16x1.5
	63		
	80	2545677	CRFK-M20x1.5
	100		

1) Suitable for ATEX

Datasheets → Internet: piston rod attachment

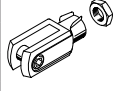
Designation	For ø	Part no.	Type
Rod clevis CRSG¹⁾			
	32	13569	CRSG-M10x1.25
	40	13570	CRSG-M12x1.25
	50	13571	CRSG-M16x1.5
	63		
	80	13572	CRSG-M20x1.5
	100		
	125	185361	CRSG-M27x2

Accessories

Bellows kit DADB



General technical data		32	40	50	63	80	100
Type DADB-V6-		32	40	50	63	80	100
Max. stroke range of the cylinder ¹⁾	[mm]	10 ... 500	10 ... 500	10 ... 500	10 ... 500	10 ... 500	10 ... 500
Type of mounting		Via threaded pin					
Mounting position		Any					
Media resistance		Dust, chippings, oil, grease, fuel (→ Internet: media resistance)					
Ambient temperature ²⁾	[°C]	-10 ... +80					
Degree of protection		IP54					
Corrosion resistance class CRC ³⁾		3 - High corrosion stress					

1) In conjunction with the bellows kit DADB

2) Note operating range of proximity switches and cylinder

3) More information www.festo.com/x/topic/crc

Materials

Sectional view

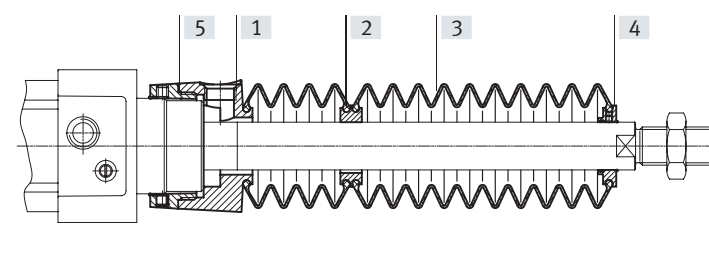

Bellows		
[1]	Connection	Polyamide
[2]	Adapter	Polyamide
[3]	Protective bellows	NBR
[4]	End piece	Polyamide
[5]	Connector	Polyamide
-	O-ring	NBR
	Note on materials	RoHS-compliant

Weight [g]		32	40	50	63	80	100
Type DADB-V6-	Stroke [mm]						
10 ... 50		29	42	71	69	99	124
51 ... 125		41	56	91	89	127	152
126 ... 175		52	68	105	103	140	165
176 ... 250		66	85	129	127	193	218
251 ... 300		79	100	147	145	231	255
301 ... 350		92	115	166	164	268	293
351 ... 375		92	115	167	165	259	284
376 ... 425		104	129	185	183	296	321
426 ... 475		117	144	204	202	334	359
476 ... 500		117	144	205	203	324	349

Accessories

Travel speed v as a function of tubing length l

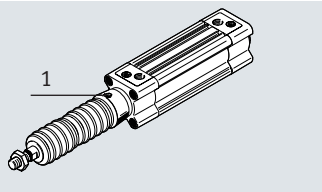

The bellows kit is a leak-free system. To prevent unwanted media from being drawn in, the supply and exhaust air for the kit must be ducted via a pressure

compensation hole in the connection part [1]. The pressure generated in the bellows kit by the positioning motion is primarily defined by the travel speed and the

tubing length. The recommended tubing length based on the travel speed of the drive can be read from the graph.

Advancing

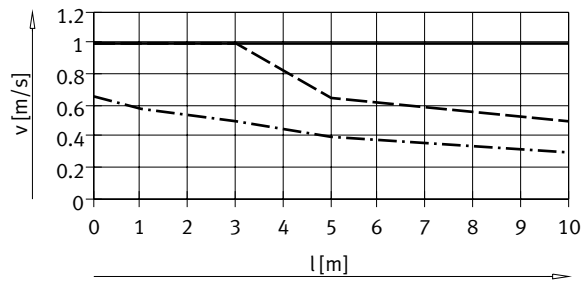

— Ø 32/50/63
 - · - · - · Ø 40
 - - - - - Ø 80/100

Retracting

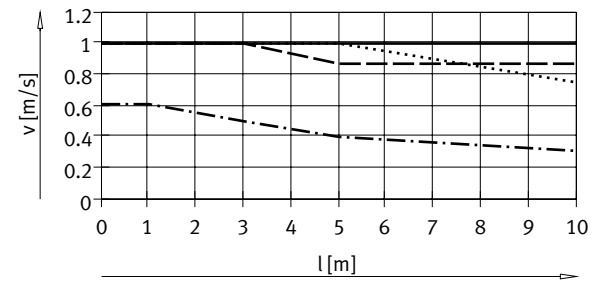

— Ø 32
 - · - · - · Ø 40
 · · · · · Ø 50/63
 · · · · · Ø 80/100

Note

The push-in fittings in the adjacent table must be used for the pressure compensation hole. Silencers can be used as an alternative. This reduces the travel speed slightly.

Tubing size and push-in fitting for pressure compensation hole

Ø [mm]	Tubing O.D. [mm]	Push-in fitting	
		Part no.	Type
32, 40	8	186109	QS-G1/8-8-I
		578376	NPQH-DK-G18-Q8-P10
		578362	NPQH-D-G18-S8-P10
50, 63, 80, 100	12	186350	QS-G1/4-12
		578344	NPQH-D-G14-Q12-P10
		578366	NPQH-D-G14-S12-P10

Accessories

Dimensions

Download CAD data → www.festo.com

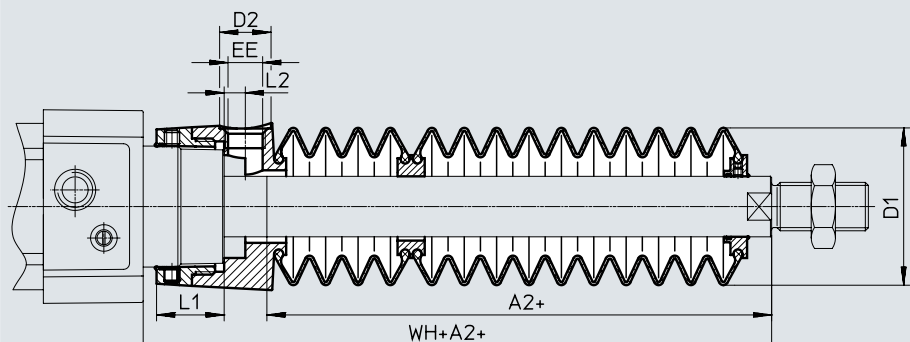

+ = plus stroke length

∅ Stroke [mm]	32							40						
	A2 ¹⁾	D1 max.	D2	EE	L1	L2	WH+A2	A2 ¹⁾	D1 max.	D2	EE	L1	L2	WH+A2
10 ... 50	29	38	14	G1/8	12.9	5.4	55	28	46	14	G1/8	16.3	5.4	56.7
51 ... 125	47						73	43						71.7
126 ... 175	61						87	56						84.7
176 ... 250	80						106	72						100.7
251 ... 300	96						122	86						114.7
301 ... 350	112						138	100						128.7
351 ... 375	114						140	101						129.7
376 ... 425	130						156	115						143.7
426 ... 475	145						171	130						158.7
476 ... 500	147	173	131	159.7										

∅ Stroke [mm]	50							63						
	A2 ¹⁾	D1 max.	D2	EE	L1	L2	WH+A2	A2 ¹⁾	D1 max.	D2	EE	L1	L2	WH+A2
10 ... 50	28	57	17	G1/4	22.35	7	63.6	28	57	17	G1/4	22.4	7	63.9
51 ... 125	46						81.6	46						81.9
126 ... 175	56						91.6	56						91.9
176 ... 250	73						108.6	73						108.9
251 ... 300	86						121.6	86						121.9
301 ... 350	97						132.6	97						132.9
351 ... 375	105						140.6	105						140.9
376 ... 425	116						151.6	116						151.9
426 ... 475	126						161.6	126						161.9
476 ... 500	134	169.6	134	169.9										

∅ Stroke [mm]	80							100						
	A2 ¹⁾	D1 max.	D2	EE	L1	L2	WH+A2	A2 ¹⁾	D1 max.	D2	EE	L1	L2	WH+A2
10 ... 50	25	93	17	G1/4	28	4	70.4	25	93	17	G1/4	28	4	74.3
51 ... 125	37						82.4	37						86.3
126 ... 175	49						94.4	49						98.3
176 ... 250	62						107.4	62						111.3
251 ... 300	74						119.4	74						123.3
301 ... 350	86						131.4	86						135.3
351 ... 375	87						132.4	87						136.3
376 ... 425	98						143.4	98						147.3
426 ... 475	110						155.4	110						159.3
476 ... 500	111	156.4	111	160.3										

1) The dimension corresponds to the E value (piston rod extension) of the drive

Accessories

Ordering data – Bellows kit

An extended piston rod (order code E) is absolutely essential when using a bellows kit
 → Ordering data – Modular product system.

The necessary dimension for order code E as a function of piston diameter and cylinder stroke as well as the corresponding bellows kit is indicated in the table below:

Order example:

Selected standards-based cylinder:

DSBG-32-320-PPV-A-...

The dimension for the corresponding E value (see table):
 112 mm

Complete order reference for standards-based cylinder:

DSBG-32-320-PPV-A-...-112E

The corresponding bellows kit:

DADB-V6-32-S301-350

Cylinder data			Bellows kit		Cylinder data			Bellows kit	
∅	Stroke	Dimension for E	Part no.	Type	∅	Stroke	Dimension for E	Part no.	Type
[mm]	[mm]	[mm]			[mm]	[mm]	[mm]		
32	10 ... 50	29	553271	DADB-V6-32-S10-50	40	10 ... 50	28	553291	DADB-V6-40-S10-50
	51 ... 125	47	553273	DADB-V6-32-S51-125		51 ... 125	43	553293	DADB-V6-40-S51-125
	126 ... 175	61	553275	DADB-V6-32-S126-175		126 ... 175	56	553295	DADB-V6-40-S126-175
	176 ... 250	80	553277	DADB-V6-32-S176-250		176 ... 250	72	553297	DADB-V6-40-S176-250
	251 ... 300	96	553279	DADB-V6-32-S251-300		251 ... 300	86	553399	DADB-V6-40-S251-300
	301 ... 350	112	553281	DADB-V6-32-S301-350		301 ... 350	100	553301	DADB-V6-40-S301-350
	351 ... 375	114	553283	DADB-V6-32-S351-375		351 ... 375	101	553303	DADB-V6-40-S351-375
	376 ... 425	130	553285	DADB-V6-32-S376-425		376 ... 425	115	553305	DADB-V6-40-S376-425
	426 ... 475	145	553287	DADB-V6-32-S426-475		426 ... 475	130	553307	DADB-V6-40-S426-475
476 ... 500	147	553289	DADB-V6-32-S476-500	476 ... 500	131	553309	DADB-V6-40-S476-500		
50	10 ... 50	28	553311	DADB-V6-50-S10-50	63	10 ... 50	28	553331	DADB-V6-63-S10-50
	51 ... 125	46	553313	DADB-V6-50-S51-125		51 ... 125	46	553333	DADB-V6-63-S51-125
	126 ... 175	56	553315	DADB-V6-50-S126-175		126 ... 175	56	553335	DADB-V6-63-S126-175
	176 ... 250	73	553317	DADB-V6-50-S176-250		176 ... 250	73	553337	DADB-V6-63-S176-250
	251 ... 300	86	553319	DADB-V6-50-S251-300		251 ... 300	86	553339	DADB-V6-63-S251-300
	301 ... 350	97	553321	DADB-V6-50-S301-350		301 ... 350	97	553341	DADB-V6-63-S301-350
	351 ... 375	105	553323	DADB-V6-50-S351-375		351 ... 375	105	553343	DADB-V6-63-S351-375
	376 ... 425	116	553325	DADB-V6-50-S376-425		376 ... 425	116	553345	DADB-V6-63-S376-425
	426 ... 475	126	553327	DADB-V6-50-S426-475		426 ... 475	126	553347	DADB-V6-63-S426-475
476 ... 500	134	553329	DADB-V6-50-S476-500	476 ... 500	134	553349	DADB-V6-63-S476-500		
80	10 ... 50	25	553351	DADB-V6-80-S10-50	100	10 ... 50	25	553371	DADB-V6-100-S10-50
	51 ... 125	37	553353	DADB-V6-80-S51-125		51 ... 125	37	553373	DADB-V6-100-S51-125
	126 ... 175	49	553355	DADB-V6-80-S126-175		126 ... 175	49	553375	DADB-V6-100-S126-175
	176 ... 250	62	553357	DADB-V6-80-S176-250		176 ... 250	62	553377	DADB-V6-100-S176-250
	251 ... 300	74	553359	DADB-V6-80-S251-300		251 ... 300	74	553379	DADB-V6-100-S251-300
	301 ... 350	86	553361	DADB-V6-80-S301-350		301 ... 350	86	553381	DADB-V6-100-S301-350
	351 ... 375	87	553363	DADB-V6-80-S351-375		351 ... 375	87	553383	DADB-V6-100-S351-375
	376 ... 425	98	553365	DADB-V6-80-S376-425		376 ... 425	98	553385	DADB-V6-100-S376-425
	426 ... 475	110	553367	DADB-V6-80-S426-475		426 ... 475	110	553387	DADB-V6-100-S426-475
476 ... 500	111	553369	DADB-V6-80-S476-500	476 ... 500	111	553389	DADB-V6-100-S476-500		

Accessories

Multi-position kit DPNC

Material:
Flange: Wrought aluminium alloy
Threaded pins, hex nuts:
Galvanised steel

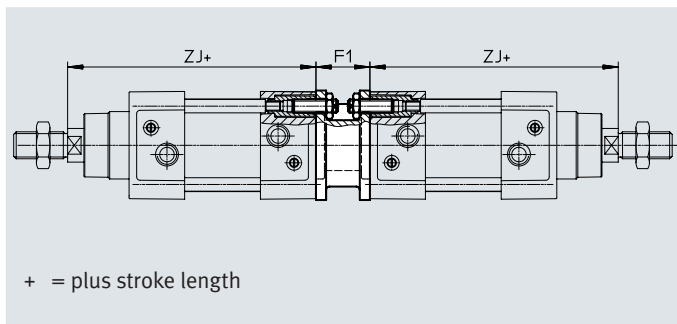

Dimensions and ordering data						
For \varnothing [mm]	F1	ZJ +1.8	Max. Total stroke [mm]	Weight [g]	Part no.	Type ¹⁾
32	27	119.1	500	292	174418	DPNC-32
40	27	133.9	800	410	174419	DPNC-40
50	32	141.8	800	335	174420	DPNC-50
63	28	157.1	700	390	174421	DPNC-63
80	38	173.6	1000	847	174422	DPNC-80
100	38	187.5	900	1200	174423	DPNC-100
125	48	225	1000	2102	174424	DPNC-125

1) Suitable for ATEX

Note

The maximum total stroke length must not be exceeded when combining cylinders and multi-position kits.

Connecting two cylinders with identical piston diameters to form a 3- or 4-position cylinder

A 3- or 4-position cylinder consists of two separate cylinders whose piston rods extend in opposite directions.

This means that, depending on the actuation and stroke pattern, this type of cylinder can assume up to four positions. In each case the cylinder is moved precisely

against a stop. Note that when one end of the piston rod is fixed, the cylinder barrel

executes the movement. The line connections to the cylinder must be flexible.

To achieve 3 positions

Two cylinders with the same stroke length must be connected to each other.

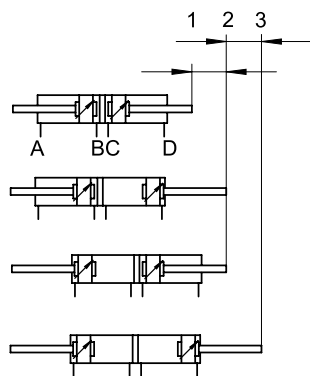

To achieve 4 positions

Two cylinders with different stroke lengths must be connected to each other.

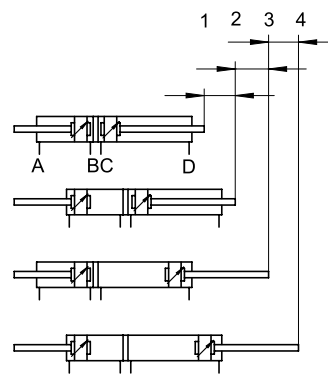

Accessories

Ordering data – Guide units for fixed strokes (recirculating ball bearing guide only)

Datasheets → Internet: feng

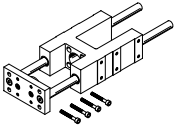
	Stroke	Part no.	Type ¹⁾	Stroke	Part no.	Type ¹⁾	
	[mm]			[mm]			
For \varnothing 32 mm				For \varnothing 40 mm			
	10 ... 50	34493	FENG-32-50-KF	10 ... 50	34499	FENG-40-50-KF	
	10 ... 100	34494	FENG-32-100-KF	10 ... 100	34500	FENG-40-100-KF	
	10 ... 160	34495	FENG-32-160-KF	10 ... 160	34501	FENG-40-160-KF	
	10 ... 200	34496	FENG-32-200-KF	10 ... 200	34502	FENG-40-200-KF	
	10 ... 250	150289	FENG-32-250-KF	10 ... 250	34503	FENG-40-250-KF	
	10 ... 320	34497	FENG-32-320-KF	10 ... 320	34504	FENG-40-320-KF	
	10 ... 400	150290	FENG-32-400-KF	10 ... 400	150291	FENG-40-400-KF	
	10 ... 500	34498	FENG-32-500-KF	10 ... 500	34505	FENG-40-500-KF	
For \varnothing 50 mm				For \varnothing 63 mm			
	10 ... 50	34506	FENG-50-50-KF	10 ... 50	34513	FENG-63-50-KF	
	10 ... 100	34507	FENG-50-100-KF	10 ... 100	34514	FENG-63-100-KF	
	10 ... 160	34508	FENG-50-160-KF	10 ... 160	34515	FENG-63-160-KF	
	10 ... 200	34509	FENG-50-200-KF	10 ... 200	34516	FENG-63-200-KF	
	10 ... 250	34510	FENG-50-250-KF	10 ... 250	34517	FENG-63-250-KF	
	10 ... 320	34511	FENG-50-320-KF	10 ... 320	34518	FENG-63-320-KF	
	10 ... 400	150292	FENG-50-400-KF	10 ... 400	34519	FENG-63-400-KF	
	10 ... 500	34512	FENG-50-500-KF	10 ... 500	34520	FENG-63-500-KF	
For \varnothing 80 mm				For \varnothing 100 mm			
	10 ... 50	34521	FENG-80-50-KF	10 ... 50	34529	FENG-100-50-KF	
	10 ... 100	34522	FENG-80-100-KF	10 ... 100	34530	FENG-100-100-KF	
	10 ... 160	34523	FENG-80-160-KF	10 ... 160	34531	FENG-100-160-KF	
	10 ... 200	34524	FENG-80-200-KF	10 ... 200	34532	FENG-100-200-KF	
	10 ... 250	34525	FENG-80-250-KF	10 ... 250	34533	FENG-100-250-KF	
	10 ... 320	34526	FENG-80-320-KF	10 ... 320	34534	FENG-100-320-KF	
	10 ... 400	34527	FENG-80-400-KF	10 ... 400	34535	FENG-100-400-KF	
	10 ... 500	34528	FENG-80-500-KF	10 ... 500	34536	FENG-100-500-KF	

Ordering data – Guide units for variable strokes

Datasheets → Internet: feng

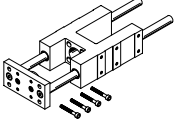
	For \varnothing [mm]	Stroke [mm]	With recirculating ball bearing guide		With plain-bearing guide	
			Part no.	Type ¹⁾	Part no.	Type ¹⁾
	32	10 ... 500	34487	FENG-32-...-KF	34481	FENG-32-...-GF
	40	10 ... 500	34488	FENG-40-...-KF	34482	FENG-40-...-GF
	50	10 ... 500	34489	FENG-50-...-KF	34483	FENG-50-...-GF
	63	10 ... 500	34490	FENG-63-...-KF	34484	FENG-63-...-GF
	80	10 ... 500	34491	FENG-80-...-KF	34485	FENG-80-...-GF
	100	10 ... 500	34492	FENG-100-...-KF	34486	FENG-100-...-GF

1) Suitable for ATEX

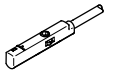
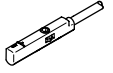

Accessories

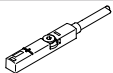
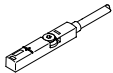
Ordering data – Proximity switch for T-slot, magneto-resistive							Datasheets → Internet: smt
	Type of mounting	Switching output	Electrical connection	Cable length [m]	Part no.	Type	
N/O							
	Inserted in the slot from above, flush with the cylinder profile, short design	PNP	Cable, 3-core	2.5	574335	SMT-8M-A-PS-24V-E-2.5-OE	
			Plug M8x1, 3-pin	0.3	574334	SMT-8M-A-PS-24V-E-0.3-M8D	
			Plug M12x1, 3-pin	0.3	574337	SMT-8M-A-PS-24V-E-0.3-M12	
		NPN	Cable, 3-core	2.5	574338	SMT-8M-A-NS-24V-E-2.5-OE	
			Plug M8x1, 3-pin	0.3	574339	SMT-8M-A-NS-24V-E-0.3-M8D	
N/C							
	Inserted in the slot from above, flush with the cylinder profile, short design	PNP	Cable, 3-core	7.5	574340	SMT-8M-A-PO-24V-E-7.5-OE	

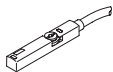

Ordering data – Proximity switch for T-slot, magnetic reed							Datasheets → Internet: sme
	Type of mounting	Switching output	Electrical connection	Cable length [m]	Part no.	Type	
N/O							
	Inserted in the slot from above, flush with the cylinder profile	Contacting	Cable, 3-core	2.5	543862	SME-8M-DS-24V-K-2.5-OE	
				5.0	543863	SME-8M-DS-24V-K-5.0-OE	
			Cable, 2-core	2.5	543872	SME-8M-ZS-24V-K-2.5-OE	
				Plug M8x1, 3-pin	0.3	543861	SME-8M-DS-24V-K-0.3-M8D
N/C							
	Inserted in the slot from above, flush with the cylinder profile	Contacting	Cable, 3-core	7.5	546799	SME-8M-DO-24V-K-7.5-OE	

Ordering data – Proximity switch for T-slot, NAMUR							Datasheets → Internet: sdbt
	Type of mounting	Switching output	Electrical connection	Cable length [m]	Part no.	Type	
N/O							
	Inserted in the slot from above, flush with cylinder profile	NAMUR	Cable, 2-core	5	579071	SDBT-MS-20NL-ZN-E-5-LE-EX6	
				10	579072	SDBT-MS-20NL-ZN-E-10-LE-EX6	

Ordering data – Safety clip for ATEX zone				Part no.	Type
	Description	For size			
	<ul style="list-style-type: none"> Protects "equipment that is not intrinsically safe" against simple disconnection, here the plug of the proximity switch SMT and connecting cable NEBU ATEX category: gas: II 3G / dust: II 3D 	Plug M8x1		548067	NEAU-M8-GD

Ordering data – Connecting cables					Datasheets → Internet: nebu
	Electrical connection, left	Electrical connection, right	Cable length [m]	Part no.	Type
	Straight socket, M8x1, 3-pin	Cable, open end, 3-core	2.5	541333	NEBU-M8G3-K-2.5-LE3
			5	541334	NEBU-M8G3-K-5-LE3
	Straight socket, M12x1, 5-pin	Cable, open end, 3-core	2.5	541363	NEBU-M12G5-K-2.5-LE3
			5	541364	NEBU-M12G5-K-5-LE3
	Angled socket, M8x1, 3-pin	Cable, open end, 3-core	2.5	541338	NEBU-M8W3-K-2.5-LE3
			5	541341	NEBU-M8W3-K-5-LE3
	Angled socket, M12x1, 5-pin	Cable, open end, 3-core	2.5	541367	NEBU-M12W5-K-2.5-LE3
			5	541370	NEBU-M12W5-K-5-LE3

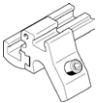
Accessories

Ordering data – Mounting kits for proximity switch SME/SMT-8				
	For \varnothing	Materials	Part no.	Type
	32 ... 100	Rail: Anodised wrought aluminium alloy Screws: High-alloy stainless steel	537806	SMBZ-8-3 2/100
	125		1451483	DASP-M4-125-A

Ordering data – Mounting kits for proximity switches SME/SMT-8					Datasheets → Internet: smbr
	For \varnothing	Mounting	CRC ¹⁾	Part no.	Type
	32 ... 100	On the cylinder barrel using clamping strap	4	538937	SMBR-8-8/100-S6

1) More information: www.festo.com/x/topic/crc

Position transmitter

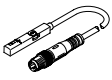
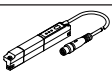

The position transmitter continuously senses the position of the piston.

It has an analogue output with an output signal that is proportional to the piston position.

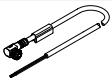
Ordering data – Position transmitter for T-slot								Datasheets → Internet: position transmitter	
	For \varnothing	Position measuring range	Analogue output		Type of mounting	Electrical connection	Cable length [m]	Part no.	Type
			[V]	[mA]					
	32 ... 125	0 ... 40	0 ... 10	–	Inserted in the slot from above	Plug M8x1, 4-pin, in-line	0.3	553744	SMAT-8M-U-E-0.3-M8D
	32 ... 125	0 ... 50	–	4 ... 20	Inserted in the slot from above	Plug M8x1, 4-pin, in-line	0.3	1531265	SDAT-MHS-M50-1L-SA-E-0.3-M8
		0 ... 80						1531266	SDAT-MHS-M80-1L-SA-E-0.3-M8
		0 ... 100						1531267	SDAT-MHS-M100-1L-SA-E-0.3-M8
		0 ... 125						1531268	SDAT-MHS-M125-1L-SA-E-0.3-M8
		0 ... 160						1531269	SDAT-MHS-M160-1L-SA-E-0.3-M8
		0 ... 50						0 ... 10	–

Ordering data – Connecting cables					Datasheets → Internet: nebu
	Electrical connection, left	Electrical connection, right	Cable length [m]	Part no.	Type
	Straight socket, M8x1, 4-pin	Cable, open end, 4-core	2.5	541342	NEBU-M8G4-K-2.5-LE4
			5	541343	NEBU-M8G4-K-5-LE4
	Angled socket, M8x1, 4-pin	Cable, open end, 4-core	2.5	541344	NEBU-M8W4-K-2.5-LE4
			5	541345	NEBU-M8W4-K-5-LE4

Accessories

Ordering data – Proximity switch, cuboid shape, pneumatic				Datasheets → Internet: smpo	
	Mounting	Pneumatic connection		Part no.	Type
3/2-way valve, normally closed					
	With accessories	Barbed connector for tubing I.D. 3 mm		31008	SMPO-1-H-B
Ordering data – Mounting kit for proximity switch SMPO-1				Datasheets → Internet: smbs	
	For ø	Mounting		Part no.	Type
	32 ... 100 mm	On the cylinder barrel using clamping strap		151226	SMBS-2
Ordering data – One-way flow control valves				Datasheets → Internet: grla	
	Connection		Material	Part no.	Type
	Thread	For tubing O.D.			
For exhaust air					
	G1/8	4	Metal design	193143	GRLA-1/8-QS-4-D
		6		193144	GRLA-1/8-QS-6-D
		8		193145	GRLA-1/8-QS-8-D
	G1/4	6		193146	GRLA-1/4-QS-6-D
		8		193147	GRLA-1/4-QS-8-D
		10		193148	GRLA-1/4QS-10-D
	G3/8	6		193149	GRLA-3/8-QS-6-D
		8		193150	GRLA-3/8-QS-8-D
		10		193151	GRLA-3/8-QS-10-D
	G1/2	12		193152	GRLA-1/2-QS-12-D