



## Short-stroke cylinders ADVC/AEVC

**FESTO**



## Key features

### At a glance

-  Diameter  
4 ... 100 mm
-  Stroke length  
2.5 ... 25 mm

Short-stroke cylinders are ideal for clamping tasks with short strokes, e.g. in machining jigs.

The courses offer:

- Rapid response when pressure is applied
- Large clamping forces in comparison to their size
- Minimal installation space
- Integrated sensor slots for contacting or contactless proximity switches
- Hole pattern for mounting to VDMA 24562 for  $\varnothing$  32 ... 100 mm

$\varnothing$  4 ... 25



$\varnothing$  6 ... 25



$\varnothing$  32 ... 100



### Installation space for 10 mm stroke

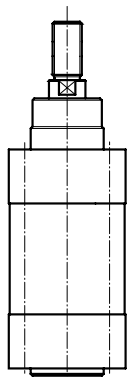

Standards-based cylinder

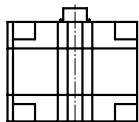

Compact cylinder

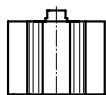

Short-stroke cylinder

## Type codes

001	Series
<b>ADVC</b>	Short-stroke cylinder, double-acting
<b>AEVC</b>	Short-stroke cylinder, single-acting

002	Piston diameter
<b>4</b>	4
<b>6</b>	6
<b>10</b>	10
<b>12</b>	12
<b>16</b>	16
<b>20</b>	20
<b>25</b>	25
<b>32</b>	32
<b>40</b>	40
<b>50</b>	50
<b>63</b>	63
<b>80</b>	80
<b>100</b>	100









003	Stroke
<b>2.5</b>	2.5
<b>5</b>	5
<b>10</b>	10
<b>15</b>	15
<b>20</b>	20
<b>25</b>	25

004	Piston rod thread
<b>A</b>	Male thread
<b>I</b>	Female thread
	None

005	Cushioning
<b>P</b>	Elastic cushioning rings/plates on both sides

006	Position sensing
	None
<b>A</b>	For proximity sensor

Product range overview

Function	Version	Type	Piston $\varnothing$ [mm]	Stroke [mm]	Position sensing
Double-acting	<b>Without position sensing</b>				
		ADVC $\varnothing$ 4 ... 25	4	2.5; 5	-
			6, 10, 12	5, 10	
			16, 20, 25	5, 10, 15, 20, 25	
		ADVC $\varnothing$ 32 ... 100	32, 40	5, 10, 15, 20, 25	-
			50, 63, 80, 100	10, 15, 20, 25	
	<b>With position sensing</b>				
		ADVC-...-A $\varnothing$ 6 ... 25	6, 10, 12	5, 10	■
			16, 20, 25	5, 10, 15, 20, 25	
		ADVC-...-A $\varnothing$ 32 ... 100	32, 40	5, 10, 15, 20, 25	■
50, 63, 80, 100			10, 15, 20, 25		
Single-acting	<b>Without position sensing</b>				
		AEVC $\varnothing$ 4 ... 25	4	2.5; 5	-
			6, 10, 12	5, 10	
			16, 20, 25	5, 10, 25	
		AEVC $\varnothing$ 32 ... 100	32	5, 10, 25	-
			40, 50, 63, 80, 100	10, 25	
	<b>With position sensing</b>				
		AEVC-...-A $\varnothing$ 6 ... 25	6, 10, 12	5, 10	■
			16, 20, 25	5, 10, 25	
		AEVC-...-A $\varnothing$ 32 ... 100	32	5, 10, 25	■
40, 50, 63, 80, 100			10, 25		

## Product range overview

Type	Piston rod			Cushioning	→ Page/Internet
	With male thread	With female thread	Without thread		
<b>Without position sensing</b>					
ADVC ø 4 ... 25	■	■ From ø 12	■ ø 4 ... 12	■	8
ADVC ø 32 ... 100	■	■	–	■	8
<b>With position sensing</b>					
ADVC...-A ø 6 ... 25	■	■ From ø 12	■ ø 6 ... 12	■	16
ADVC...-A ø 32 ... 100	■	■	–	■	16
<b>Without position sensing</b>					
AEVC ø 4 ... 25	■	■ From ø 12	■ ø 4 ... 12	■	24
AEVC ø 32 ... 100	■	■	–	■	24
<b>With position sensing</b>					
AEVC...-A ø 6 ... 25	■	■ From ø 12	■ ø 6 ... 12	■	32
AEVC...-A ø 32 ... 100	■	■	–	■	32

Peripherals overview

∅ 32 ... 100 mm

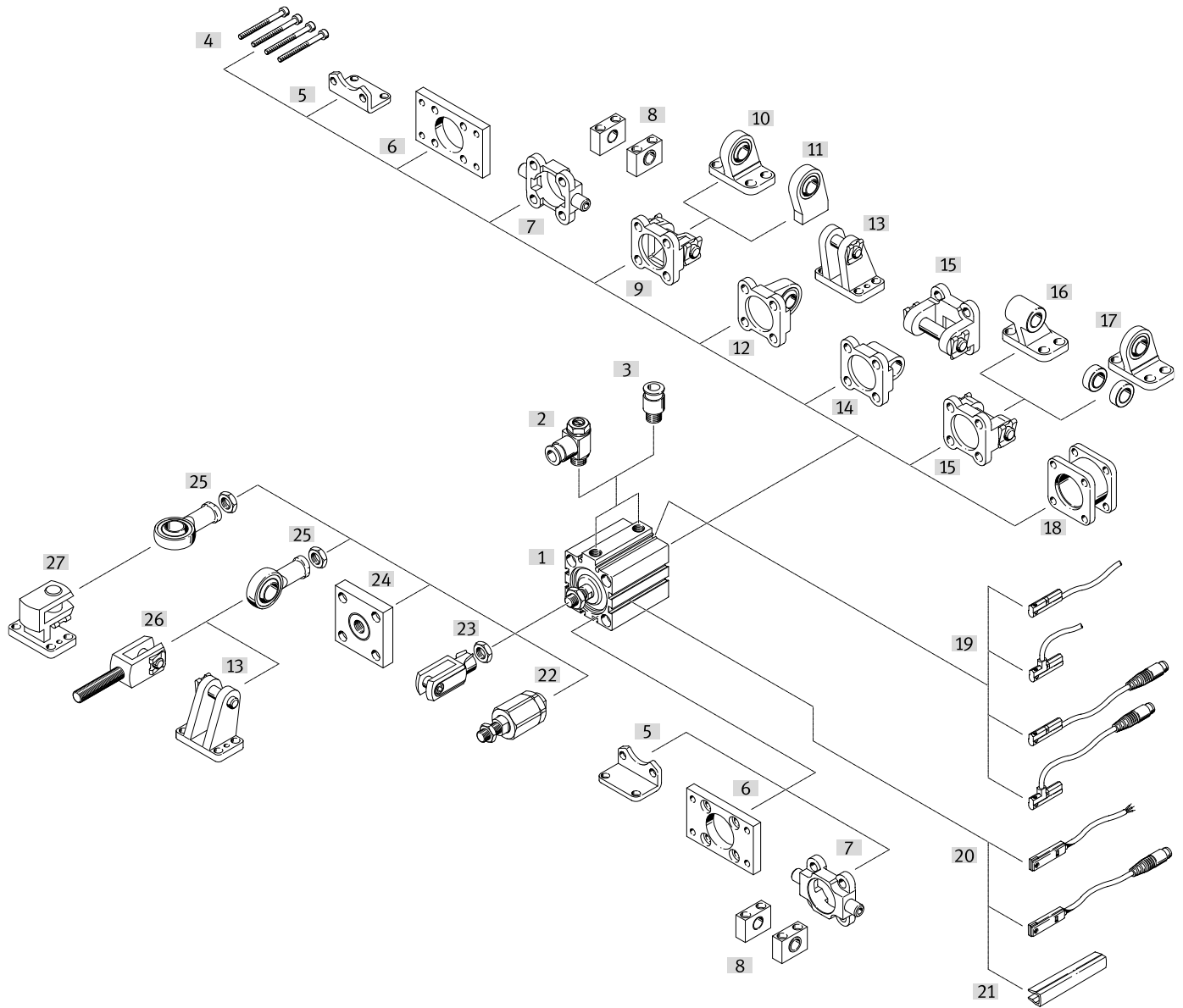

∅ 4 ... 25 mm  
Without position sensing



∅ 6 ... 25 mm  
With position sensing

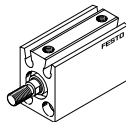

## Peripherals overview

Mounting attachments and accessories		Description	Piston $\varnothing$			→ Page/Internet
			4, 6, 12	10, 16 ... 25	32 ... 100	
[1]	Short-stroke cylinder ADVC	Double-acting	Without position sensing	4 ... 100		8
			With position sensing	6 ... 100		16
	Short-stroke cylinder AEVC	Single-acting	Without position sensing	4 ... 100		24
			With position sensing	6 ... 100		32
[2]	One-way flow control valve GRLA	For regulating speed	■	■	■	50
[3]	Push-in fitting QS	For connecting tubing with standard O.D.	■	■	■	qs
[4]	Retaining screws	Not included in the scope of delivery	■ DIN 84	■ DIN 912	■ DIN 912	–
	Retaining screws for $\varnothing$ 80, 100	Not included in the scope of delivery	–	–	■	–
[5]	Foot mounting HNC	For bearing and end caps	–	–	■	39
[6]	Flange mounting FNC	For bearing or end caps	–	–	■	40
[7]	Trunnion flange ZNCF	For bearing or end caps	–	–	■	41
[8]	Trunnion support LNZG	–	–	–	■	42
[9]	Swivel flange SNC	For end caps	–	–	■	43
[10]	Clevis foot LSNG	With spherical bearing	–	–	■	47
[11]	Clevis foot LSNSG	Weld-on, with spherical bearing	–	–	■	47
[12]	Swivel flange SNCS	With spherical bearing for end caps	–	–	■	45
[13]	Clevis foot LBG	–	–	–	■	47
[14]	Swivel flange SNCL	For end caps	–	–	■	46
[15]	Swivel flange SNCB	For end caps	–	–	■	44
[16]	Clevis foot LNG	–	–	–	■	47
[17]	Clevis foot LSN	With spherical bearing	–	–	■	47
[18]	Multi-position kit DPNC	For connecting two cylinders with the same piston diameter to form a multi-position cylinder	–	–	■	38
[19]	Proximity switch SME/SMT-10	Can be integrated in the cylinder profile barrel	–	■	■	49
[20]	Proximity switch SME/SMT-8	Can be integrated in the cylinder profile barrel	–	–	■	49
[21]	Slot cover ABP-5-S	For protecting the sensor cables and the sensor slots from contamination	–	–	■	50
[22]	Self-aligning rod coupler FK	To compensate for radial and angular deviations	■ $\varnothing$ 12	■	■	48
[23]	Rod clevis SG	Permits a swivelling movement of the cylinder in one plane	–	■	■	48
[24]	Coupling piece KSG	To compensate for radial deviations	–	–	■	48
[25]	Rod eye SGS	With spherical bearing	–	■	■	48
[26]	Rod clevis SGA	With male thread	–	–	■	48
[27]	Right-angle clevis foot LQG	–	–	■	■	47

Datasheet – Double-acting, without position sensing

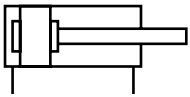

- Diameter  
4 ... 100 mm
- Stroke length  
2.5 ... 25 mm



General technical data													
Piston $\varnothing$	4	6	10	12	16	20	25	32	40	50	63	80	100
Pneumatic connection	M3	M3	M5	M5	M5	M5	M5	G1/8	G1/8	G1/8	G1/8	G1/8	G1/4
Piston rod with female thread	–	–	–	■	■	■	■	■	■	■	■	■	■
Piston rod with male thread	■	■	■	■	■	■	■	■	■	■	■	■	■
Piston rod without thread	■	■	■	■	–	–	–	–	–	–	–	–	–
Operating medium	Compressed air to ISO 8573-1:2010 [7:4:4]												
Note on the operating/pilot medium	Lubricated operation possible (in which case lubricated operation will always be required)												
Design	Piston												
	Piston rod												
Cushioning	Elastic cushioning rings/plates at both ends												
Type of mounting	Via through-hole							Via through-hole					
	–							With accessories					
Mounting position	Any												

Operating conditions														
Piston $\varnothing$	4	6	10	12	16	20	25	32	40	50	63	80	100	
Operating pressure	[MPa]	0.2 ... 0.8	0.15 ... 0.8	0.1 ... 0.8	0.1 ... 1						0.06 ... 1		0.1 ... 1	
	[bar]	2 ... 8	1.5 ... 8	1 ... 8	1 ... 10						0.6 ... 10		1 ... 10	
	[psi]	29 ... 116	21.75 ... 116	14.5 ... 116	14.5 ... 145						8.7 ... 145		14.5 ... 145	
Ambient temperature	[°C]	–20 ... +80												
Corrosion resistance class CRC <sup>1)</sup>	1 - Low corrosion stress													

1) More information: [www.festo.com/x/topic/crc](http://www.festo.com/x/topic/crc)



## Datasheet – Double-acting, without position sensing

Forces [N] and impact energy [J]													
Piston $\varnothing$	4	6	10	12	16	20	25	32	40	50	63	80	100
Theoretical force at 0.6 MPa (6 bar, 87 psi), advancing	7.5	17	47	68	121	189	295	483	754	1178	1870	3016	4712
Theoretical force at 0.6 MPa (6 bar, 87 psi), retracting	5.7	13	40	51	91	141	247	415	686	1056	1750	2847	4418
Max. impact energy in the end positions	0.003	0.005	0.03	0.06	0.10	0.14	0.18	0.26	0.36	0.60	0.64	0.90	1.20

Product weight [g]													
Stroke [mm]	Piston $\varnothing$												
	4	6	10	12	16	20	25	32	40	50	63	80	100
2.5	3	–	–	–	–	–	–	–	–	–	–	–	–
5	4.2	7.5	20	30	43	80	102	173	250	–	–	–	–
10	–	10	21	35	51	95	116	193	270	388	590	1052	2079
15	–	–	–	–	58	106	129	210	290	411	663	1102	2161
20	–	–	–	–	66	119	145	229	321	447	704	1167	2338
25	–	–	–	–	72	131	157	246	344	481	742	1219	2400

Moving mass [g]													
Stroke [mm]	Piston $\varnothing$												
	4	6	10	12	16	20	25	32	40	50	63	80	100
2.5	0.2	–	–	–	–	–	–	–	–	–	–	–	–
5	0.25	1.2	2.8	6.6	11	22	27	46	69	–	–	–	–
10	–	1.5	3.3	7.7	13	25	30	51	74	127	178	339	719
15	–	–	–	–	15	28	33	56	79	135	186	351	739
20	–	–	–	–	17	31	36	61	84	143	194	363	759
25	–	–	–	–	19	34	39	66	89	151	202	375	779

## Materials

Sectional view

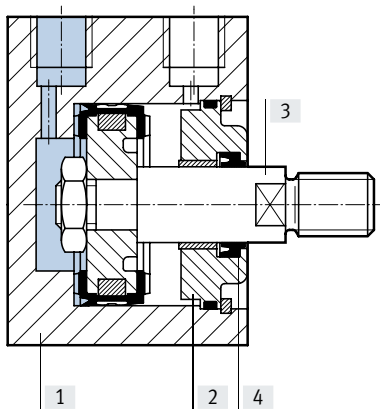

Short-stroke cylinder	$\varnothing 4$	$\varnothing 6 \dots 100$
[1] Cylinder barrel	Anodised aluminium	Anodised aluminium
[2] Cover	Anodised aluminium	Anodised aluminium
[3] Piston rod	Anodised aluminium	High-alloy steel
[4] Rod seal	Nitrile rubber	Polyurethane
– Note on materials	RoHS-compliant	RoHS-compliant
LABS (PWIS) conformity	VDMA24364-B1/B2-L	VDMA24364-B1/B2-L
LABS (PWIS) criterion	Free of paint-wetting impairment substances to FN 942010	Free of paint-wetting impairment substances to FN 942010

Datasheet – Double-acting, without position sensing

Dimensions

Download CAD data → [www.festo.com](http://www.festo.com)

∅ 4 ... 25 mm

ADVC-...-I-P, piston rod with female thread

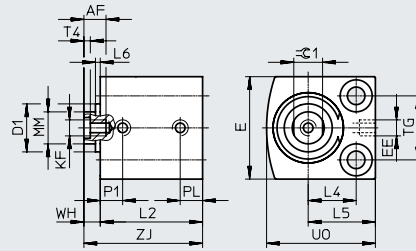

ADVC-...-A-P, piston rod with male thread

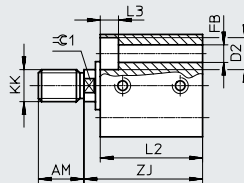

ADVC-...-P, piston rod without thread

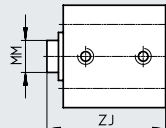

∅ 4 mm:

Do not exceed the maximum screw-in depth of 3 mm and maximum tightening torque of 0.7 Nm.

∅ 10 mm

The bearing cap can protrude by up to 0.65 mm depending on the tolerance position.

∅ 12 mm

The bearing cap can protrude by up to 0.35 mm depending on the tolerance position.

[1] No undercut with diameter 4/6/10

## Datasheet – Double-acting, without position sensing

∅ [mm]	Stroke [mm]	AF min.	AM -0.5	D1 ∅ max.	D2 ∅	E max.	EE	FB ∅	KF	KK	L2 +0.2	L3
4	2.5	-	6	-	3.3 <sup>+0.1</sup>	10	M3	1.8	-	M2	13	1.8
	5										15.5	
6	5	-	6	-	5 <sup>+0.1</sup>	13	M3	2.9	-	M3	16	2.9
	10										21	
10	5	-	8	7.5	5.8 <sup>+0.1</sup>	18	M5	3.4	-	M4	21	3.4
	10										24	
12	5	8	8	10.7	6 <sup>H13</sup>	20	M5	3.4	M3	M5	23	3.4
	10										28	
16	5	10	12	-	8 <sup>H13</sup>	25	M5	4.5	M4	M6	23	4.6
	10										28	
	15										33	
	20										38	
	25										43	
20	5	12	12	-	10 <sup>H13</sup>	32	M5	5.5	M5	M8	27	5.7
	10										32	
	15										37	
	20										42	
	25										47	
25	5	12	12	-	10 <sup>H13</sup>	38	M5	5.5	M5	M8	27.5	5.7
	10										32.5	
	15										37.5	
	20										42.5	
	25										47.5	

∅ [mm]	Stroke [mm]	L4	L5	L6 max.	MM ∅	P1	PL	T4	TG ±0.1	UO max.	WH	ZJ ±0.8	≅G1
4	2.5	4	6.5	-	2	3.7	3.2	-	5.8	10	1	14	-
	5											16.5	
6	5	6	9	-	3	4.7	3	-	7	14	1	17	-
	10											22	
10	5	8	11.5	0.7	4	5.2	5.2	-	11	19	1.5	22.5	-
	10					6	5.5					25.5	
12	5	9	13	0.4	6	5.75	5.75	1.5	13	22	4	27	5
	10					9	6					32	
16	5	11.5	16.5	-	8	6	6	2	15	27	4	27	7
	10					7.5						32	
	15						37						
	20						42						
	25						47						
20	5	15	21	-	10	7.5	7	2	20	34	5	32	9
	10											37	
	15											42	
	20											47	
	25											52	
25	5	15.5	21.5	-	10	8	6.5	2	26	37	5	32.5	9
	10											37.5	
	15											42.5	
	20											47.5	
	25											52.5	

Datasheet – Double-acting, without position sensing

Dimensions

Download CAD data → [www.festo.com](http://www.festo.com)

∅ 32 ... 100 mm

ADVC-...-I-P, piston rod with female thread

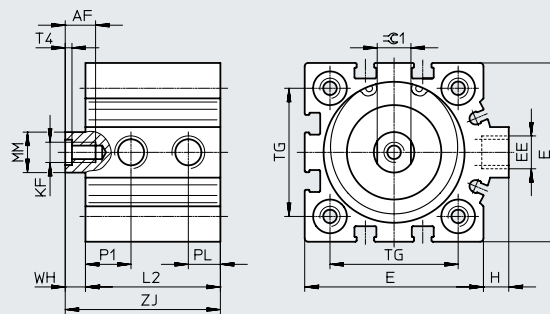

ADVC-...-A-P\*\*, piston rod with male thread

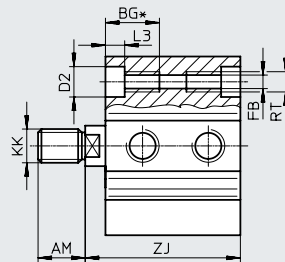

∅ [mm]	AF min.	AM -0.5	BG* min.	D2 ∅ F9	E max.	EE	FB ∅	H	KF	KK
32	12	14	21.7	9	45	G1/8	5.2	7	M6	M10x1.25
40	12	14	21.7	9	53.5	G1/8	5.2	7	M6	M10x1.25
50	16	16	22.8	11	63.5	G1/8	6.8	7	M8	M12x1.25
63	16	16	22.8	11	75	G1/8	6.8	7.5	M8	M12x1.25
80	20	22	25	14	93	G1/8	8.5	7	M10	M16x1.5
100	24	28	25	14	113	G1/4	8.5	13	M12	M20x1.5

\* Continuous thread with shorter sizes

\*\* Nut for piston rod thread included in the scope of delivery

## Datasheet – Double-acting, without position sensing

∅ [mm]	Stroke [mm]	L2 +0.2	L3	MM ∅	P1	PL	RT	T4	TG ±0.1	WH	ZJ ±0.8	≅C1
32	5	34	5.7	12	9	8.5	M6	2.6	32.5	6	40	10
	10	39									45	
	15	44									50	
	20	49									55	
	25	54									60	
40	5	34.5	5.7	12	11	9	M6	2.6	38	6	40.5	10
	10	39.5									45.5	
	15	44.5									50.5	
	20	49.5									55.5	
	25	54.5									60.5	
50	10	38	6.8	16	11.3	9.5	M8	3.3	46.5	8	46	13
	15	43									51	
	20	48									56	
	25	53									61	
63	10	45	6.8	16	12.5	11.5	M8	3.3	56.5	8	53	13
	15	50									58	
	20	55									63	
	25	60									68	
80	10	50	9	20	15	15	M10	4.7	72	8	58	17
	15	55									63	
	20	60									68	
	25	65									73	
100	10	59	9	25	16.5	19	M10	6.1	89	10	69	22
	15	64									74	
	20	69									79	
	25	74									84	

Datasheet – Double-acting, without position sensing

Ordering data				
Type	Piston ø	Stroke	Piston rod without thread	
	[mm]	[mm]	Part no.	Type
	4	2.5	526897	ADVC-4-2.5-P
		5	526898	ADVC-4-5-P
	6	5	526899	ADVC-6-5-P
		10	526900	ADVC-6-10-P
	10	5	526903	ADVC-10-5-P
		10	526904	ADVC-10-10-P
	12	5	530568	ADVC-12-5-P
		10	530569	ADVC-12-10-P

Ordering data								
Type	Piston ø	Stroke	Piston rod with male thread		Piston rod with female thread			
			Part no.	Type	Part no.	Type		
	4	2.5	188054	ADVC-4-2.5-A-P	-			
		5	188055	ADVC-4-5-A-P				
	6	5	188066	ADVC-6-5-A-P				
		10	188067	ADVC-6-10-A-P				
	10	5	188078	ADVC-10-5-A-P				
		10	188079	ADVC-10-10-A-P				
	12	5	188094	ADVC-12-5-A-P			188090	ADVC-12-5-I-P
		10	188095	ADVC-12-10-A-P			188091	ADVC-12-10-I-P
	16	5	188123	ADVC-16-5-A-P			188113	ADVC-16-5-I-P
		10	188124	ADVC-16-10-A-P			188114	ADVC-16-10-I-P
		15	188125	ADVC-16-15-A-P	188115	ADVC-16-15-I-P		
		20	188126	ADVC-16-20-A-P	188116	ADVC-16-20-I-P		
		25	188127	ADVC-16-25-A-P	188117	ADVC-16-25-I-P		
	20	5	188155	ADVC-20-5-A-P	188145	ADVC-20-5-I-P		
		10	188156	ADVC-20-10-A-P	188146	ADVC-20-10-I-P		
		15	188157	ADVC-20-15-A-P	188147	ADVC-20-15-I-P		
		20	188158	ADVC-20-20-A-P	188148	ADVC-20-20-I-P		
		25	188159	ADVC-20-25-A-P	188149	ADVC-20-25-I-P		
	25	5	188187	ADVC-25-5-A-P	188177	ADVC-25-5-I-P		
		10	188188	ADVC-25-10-A-P	188178	ADVC-25-10-I-P		
15		188189	ADVC-25-15-A-P	188179	ADVC-25-15-I-P			
20		188190	ADVC-25-20-A-P	188180	ADVC-25-20-I-P			
25		188191	ADVC-25-25-A-P	188181	ADVC-25-25-I-P			

## Datasheet – Double-acting, without position sensing

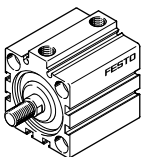
Ordering data							
Type	Piston ø [mm]	Stroke [mm]	Piston rod with male thread		Piston rod with female thread		
			Part no.	Type	Part no.	Type	
	32	5	188219	ADVC-32-5-A-P	188209	ADVC-32-5-I-P	
		10	188220	ADVC-32-10-A-P	188210	ADVC-32-10-I-P	
		15	188221	ADVC-32-15-A-P	188211	ADVC-32-15-I-P	
		20	188222	ADVC-32-20-A-P	188212	ADVC-32-20-I-P	
		25	188223	ADVC-32-25-A-P	188213	ADVC-32-25-I-P	
	40	5	188247	ADVC-40-5-A-P	188237	ADVC-40-5-I-P	
		10	188248	ADVC-40-10-A-P	188238	ADVC-40-10-I-P	
		15	188249	ADVC-40-15-A-P	188239	ADVC-40-15-I-P	
		20	188250	ADVC-40-20-A-P	188240	ADVC-40-20-I-P	
		25	188251	ADVC-40-25-A-P	188241	ADVC-40-25-I-P	
	50	10	188272	ADVC-50-10-A-P	188264	ADVC-50-10-I-P	
		15	188273	ADVC-50-15-A-P	188265	ADVC-50-15-I-P	
		20	188274	ADVC-50-20-A-P	188266	ADVC-50-20-I-P	
		25	188275	ADVC-50-25-A-P	188267	ADVC-50-25-I-P	
	63	10	188296	ADVC-63-10-A-P	188288	ADVC-63-10-I-P	
		15	188297	ADVC-63-15-A-P	188289	ADVC-63-15-I-P	
		20	188298	ADVC-63-20-A-P	188290	ADVC-63-20-I-P	
		25	188299	ADVC-63-25-A-P	188291	ADVC-63-25-I-P	
	80	10	188320	ADVC-80-10-A-P	188312	ADVC-80-10-I-P	
		15	188321	ADVC-80-15-A-P	188313	ADVC-80-15-I-P	
20		188322	ADVC-80-20-A-P	188314	ADVC-80-20-I-P		
25		188323	ADVC-80-25-A-P	188315	ADVC-80-25-I-P		
100	10	188344	ADVC-100-10-A-P	188336	ADVC-100-10-I-P		
	15	188345	ADVC-100-15-A-P	188337	ADVC-100-15-I-P		
	20	188346	ADVC-100-20-A-P	188338	ADVC-100-20-I-P		
	25	188347	ADVC-100-25-A-P	188339	ADVC-100-25-I-P		

Datasheet – Double-acting, with position sensing

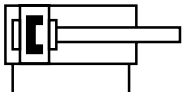

- - Diameter  
6 ... 100 mm
- - Stroke length  
5 ... 25 mm

General technical data												
Piston $\varnothing$	6	10	12	16	20	25	32	40	50	63	80	100
Pneumatic connection	M3	M5	M5	M5	M5	M5	G1/8	G1/8	G1/8	G1/8	G1/8	G1/4
Piston rod with female thread	–	–	■	■	■	■	■	■	■	■	■	■
Piston rod with male thread	■	■	■	■	■	■	■	■	■	■	■	■
Piston rod without thread	■	■	■	–	–	–	–	–	–	–	–	–
Operating medium	Compressed air to ISO 8573-1:2010 [7:4:4]											
Note on the operating/pilot medium	Lubricated operation possible (in which case lubricated operation will always be required)											
Design	Piston											
	Piston rod											
Cushioning	Elastic cushioning rings/plates at both ends											
Position sensing	For proximity switch											
Type of mounting	Via through-hole						Via through-hole					
	–						With accessories					
Mounting position	Any											

Operating conditions													
Piston $\varnothing$	6	10	12	16	20	25	32	40	50	63	80	100	
Operating pressure	[MPa]	0.15 ... 0.8	0.1 ... 0.8	0.1 ... 1						0.06 ... 1		0.1 ... 1	
	[bar]	1.5 ... 8	1 ... 8	1 ... 10						0.6 ... 10		1 ... 10	
	[psi]	21.75 ... 116	14.5 ... 116	14.5 ... 145						8.7 ... 145		14.5 ... 145	
Ambient temperature	[°C]	–20 ... +80 (observe operating range of proximity switches)											
Corrosion resistance class CRC <sup>1)</sup>	1 - Low corrosion stress												

1) More information: [www.festo.com/x/topic/crc](http://www.festo.com/x/topic/crc)



## Datasheet – Double-acting, with position sensing

Forces [N] and impact energy [J]												
Piston $\varnothing$	6	10	12	16	20	25	32	40	50	63	80	100
Theoretical force at 0.6 MPa (6 bar, 87 psi), advancing	17	47	68	121	189	295	483	754	1178	1870	3016	4712
Theoretical force at 0.6 MPa (6 bar, 87 psi), retracting	13	40	51	91	141	247	415	686	1056	1750	2847	4418
Max. impact energy in the end positions	0.005	0.03	0.06	0.10	0.14	0.18	0.26	0.36	0.60	0.64	0.90	1.20

Product weight [g]												
Stroke [mm]	Piston $\varnothing$											
	6	10	12	16	20	25	32	40	50	63	80	100
5	14	29	57	79	120	151	184	298	–	–	–	–
10	17	35	64	90	134	168	201	323	459	626	1176	2200
15	–	–	–	100	148	183	225	344	488	701	1233	2325
20	–	–	–	110	160	200	239	370	528	740	1297	2290
25	–	–	–	120	178	217	242	377	553	778	1348	2366

Moving mass [g]												
Stroke [mm]	Piston $\varnothing$											
	6	10	12	16	20	25	32	40	50	63	80	100
5	1.7	3.2	8.5	15	26	32	50	66	–	–	–	–
10	2	3.7	9.6	17	29	35	55	71	116	158	289	555
15	–	–	–	19	32	38	60	76	124	166	301	575
20	–	–	–	21	35	41	65	81	132	174	313	595
25	–	–	–	23	38	44	70	86	140	182	325	615

## Materials

Sectional view

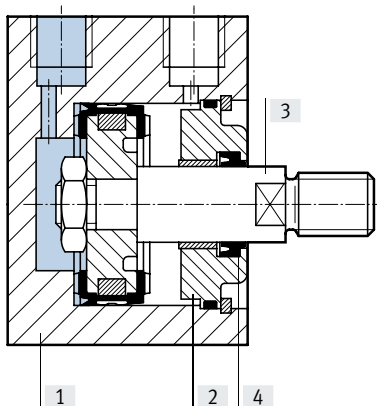

Short-stroke cylinder		
[1]	Cylinder barrel	Anodised aluminium
[2]	Cover	Anodised aluminium
[3]	Piston rod	High-alloy steel
[4]	Rod seal	Polyurethane
–	Note on materials	RoHS-compliant
	LABS (PWIS) conformity	VDMA24364-B1/B2-L
	LABS (PWIS) criterion	Free of paint-wetting impairment substances to FN 942010

Datasheet – Double-acting, with position sensing

Dimensions

Download CAD data → [www.festo.com](http://www.festo.com)

∅ 6 ... 25 mm

ADVC-...-I-P-A, piston rod with female thread

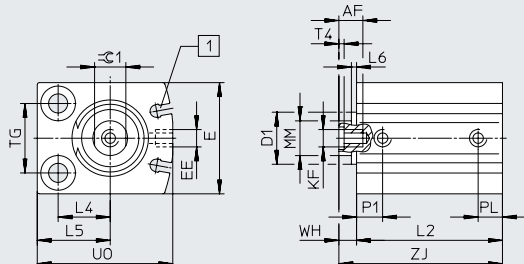

ADVC-...-A-P-A, piston rod with male thread

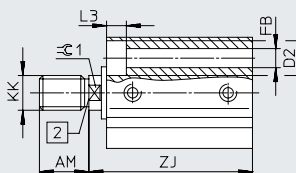

ADVC-...-P-A, piston rod without thread

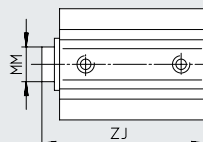

∅ 10 mm

The bearing cap can protrude by up to 0.65 mm depending on the tolerance position.

∅ 12 mm

The bearing cap can protrude by up to 0.35 mm depending on the tolerance position.

[1] Slot for proximity switch SME/SMT-10

[2] No undercut with diameter 6/10

∅ [mm]	Stroke [mm]	AF min.	AM -0.5	D1 ∅ max.	D2 ∅	E max.	EE	FB ∅	KF	KK	L2 +0.2	L3
6	5	-	6	-	5 +0.1	16	M3	2.9	-	M3	25.5	2.9
	10										30.5	
10	5	-	8	7.5	5.8 +0.1	21	M5	3.4	-	M4	27	3.4
	10										32	
12	5	8	8	10.7	6 H13	24	M5	3.4	M3	M5	36	3.4
	10										41	
16	5	10	12	-	8 H13	28	M5	4.5	M4	M6	35	4.6
	10										40	
	15										45	
	20										50	
	25										55	
20	5	12	12	-	10 H13	32	M5	5.5	M5	M8	37	5.7
	10										42	
	15										47	
	20										52	
	25										57	
25	5	12	12	-	10 H13	38	M5	5.5	M5	M8	37	5.7
	10										42	
	15										47	
	20										52	
	25										57	

## Datasheet – Double-acting, with position sensing

∅ [mm]	Stroke [mm]	L4	L5	L6 max.	MM ∅	P1	PL	T4	TG ±0.1	UO max.	WH	ZJ ±0.8	≅C1
6	5	5	8	–	3	5.2	3	–	10	16	1	26.5	–
	10											31.5	
10	5	7	10.5	0.7	4	6	6	–	14	22	1.5	28.5	–
	10											33.5	
12	5	8	12	0.4	6	7	6	1.5	16	26	4	40	5
	10											45	
16	5	12	17	–	8	8	6	2	18	32	4	39	7
	10											44	
	15											49	
	20											54	
	25											59	
20	5	15	21	–	10	7.5	7	2	20	39	5	42	9
	10											47	
	15											52	
	20											57	
	25											62	
25	5	15.5	21.5	–	10	10	6	2	26	42	5	42	9
	10											47	
	15											52	
	20											57	
	25											62	

Datasheet – Double-acting, with position sensing

Dimensions

Download CAD data → [www.festo.com](http://www.festo.com)

∅ 32 ... 100 mm

ADVC-...-I-P-A, piston rod with female thread

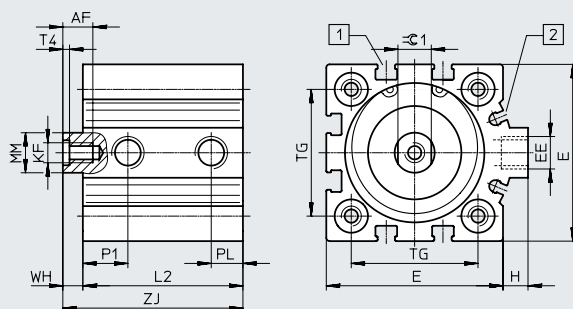

ADVC-...-A-P-A \*\*, piston rod with male thread

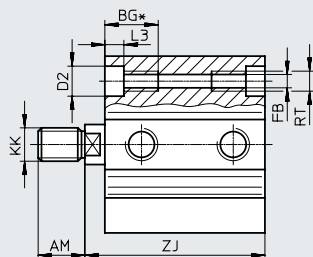

- [1] Slot for proximity switch SME/SMT-8
- [2] Slot for proximity switch SME/SMT-10

∅	AF	AM	BG*	D2	E	EE	FB	H	KF	KK
[mm]	min.	-0.5	min.	∅ F9	max.		∅			
32	12	14	21.7	9	45	G1/8	5.2	7	M6	M10x1.25
40	12	14	21.7	9	53.5	G1/8	5.2	7	M6	M10x1.25
50	16	16	22.8	11	63.5	G1/8	6.8	7	M8	M12x1.25
63	16	16	22.8	11	75	G1/8	6.8	7.5	M8	M12x1.25
80	20	22	25	14	93	G1/8	8.5	7	M10	M16x1.5
100	24	28	25	14	113	G1/4	8.5	13	M12	M20x1.5

\* Continuous thread with shorter sizes  
 \*\* Nut for piston rod thread included in the scope of delivery

## Datasheet – Double-acting, with position sensing

∅ [mm]	Stroke [mm]	L2 +0.2	L3	MM ∅	P1	PL	RT	T4	TG ±0.1	WH	ZJ ±0.8	⊖1
32	5	38	5.7	12	9	8.5	M6	2.6	32.5	6	44	10
	10	43									49	
	15	48									54	
	20	53									59	
	25	58									64	
40	5	43	5.7	12	13.5	9.5	M6	2.6	38	6	49	10
	10	48									54	
	15	53									59	
	20	58									64	
	25	63									69	
50	10	48	6.8	16	11.3	9.5	M8	3.3	46.5	8	56	13
	15	53									61	
	20	58									66	
	25	63									71	
63	10	51	6.8	16	12.5	10.5	M8	3.3	56.5	8	59	13
	15	56									64	
	20	61									69	
	25	66									74	
80	10	59	9	20	15	8.5	M10	4.7	72	8	67	17
	15	64									72	
	20	69									77	
	25	74									82	
100	10	68	9	25	16.5	10.5	M10	6.1	89	10	78	22
	15	73									83	
	20	78									88	
	25	83									93	

Datasheet – Double-acting, with position sensing

Ordering data				
Type	Piston ø	Stroke	Piston rod without thread	
	[mm]	[mm]	Part no.	Type
	6	5	526901	ADVC-6-5-P-A
		10	526902	ADVC-6-10-P-A
	10	5	526905	ADVC-10-5-P-A
		10	526906	ADVC-10-10-P-A
	12	5	530572	ADVC-12-5-P-A
		10	530573	ADVC-12-10-P-A

Ordering data								
Type	Piston ø	Stroke	Piston rod with male thread		Piston rod with female thread			
			Part no.	Type	Part no.	Type		
	6	5	188064	ADVC-6-5-A-P-A	-			
		10	188065	ADVC-6-10-A-P-A				
	10	5	188076	ADVC-10-5-A-P-A				
		10	188077	ADVC-10-10-A-P-A				
	12	5	188092	ADVC-12-5-A-P-A			188088	ADVC-12-5-I-P-A
		10	188093	ADVC-12-10-A-P-A			188089	ADVC-12-10-I-P-A
	16	5	188118	ADVC-16-5-A-P-A	188108	ADVC-16-5-I-P-A		
		10	188119	ADVC-16-10-A-P-A	188109	ADVC-16-10-I-P-A		
		15	188120	ADVC-16-15-A-P-A	188110	ADVC-16-15-I-P-A		
		20	188121	ADVC-16-20-A-P-A	188111	ADVC-16-20-I-P-A		
		25	188122	ADVC-16-25-A-P-A	188112	ADVC-16-25-I-P-A		
	20	5	188150	ADVC-20-5-A-P-A	188140	ADVC-20-5-I-P-A		
		10	188151	ADVC-20-10-A-P-A	188141	ADVC-20-10-I-P-A		
		15	188152	ADVC-20-15-A-P-A	188142	ADVC-20-15-I-P-A		
		20	188153	ADVC-20-20-A-P-A	188143	ADVC-20-20-I-P-A		
		25	188154	ADVC-20-25-A-P-A	188144	ADVC-20-25-I-P-A		
	25	5	188182	ADVC-25-5-A-P-A	188172	ADVC-25-5-I-P-A		
		10	188183	ADVC-25-10-A-P-A	188173	ADVC-25-10-I-P-A		
15		188184	ADVC-25-15-A-P-A	188174	ADVC-25-15-I-P-A			
20		188185	ADVC-25-20-A-P-A	188175	ADVC-25-20-I-P-A			
25		188186	ADVC-25-25-A-P-A	188176	ADVC-25-25-I-P-A			

## Datasheet – Double-acting, with position sensing

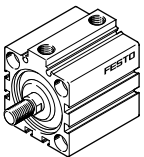
Ordering data							
Type	Piston ø [mm]	Stroke [mm]	Piston rod with male thread		Piston rod with female thread		
			Part no.	Type	Part no.	Type	
	32	5	188214	ADVC-32-5-A-P-A	188204	ADVC-32-5-I-P-A	
		10	188215	ADVC-32-10-A-P-A	188205	ADVC-32-10-I-P-A	
		15	188216	ADVC-32-15-A-P-A	188206	ADVC-32-15-I-P-A	
		20	188217	ADVC-32-20-A-P-A	188207	ADVC-32-20-I-P-A	
		25	188218	ADVC-32-25-A-P-A	188208	ADVC-32-25-I-P-A	
	40	5	188242	ADVC-40-5-A-P-A	188232	ADVC-40-5-I-P-A	
		10	188243	ADVC-40-10-A-P-A	188233	ADVC-40-10-I-P-A	
		15	188244	ADVC-40-15-A-P-A	188234	ADVC-40-15-I-P-A	
		20	188245	ADVC-40-20-A-P-A	188235	ADVC-40-20-I-P-A	
		25	188246	ADVC-40-25-A-P-A	188236	ADVC-40-25-I-P-A	
	50	10	188268	ADVC-50-10-A-P-A	188260	ADVC-50-10-I-P-A	
		15	188269	ADVC-50-15-A-P-A	188261	ADVC-50-15-I-P-A	
		20	188270	ADVC-50-20-A-P-A	188262	ADVC-50-20-I-P-A	
		25	188271	ADVC-50-25-A-P-A	188263	ADVC-50-25-I-P-A	
	63	10	188292	ADVC-63-10-A-P-A	188284	ADVC-63-10-I-P-A	
		15	188293	ADVC-63-15-A-P-A	188285	ADVC-63-15-I-P-A	
		20	188294	ADVC-63-20-A-P-A	188286	ADVC-63-20-I-P-A	
		25	188295	ADVC-63-25-A-P-A	188287	ADVC-63-25-I-P-A	
	80	10	188316	ADVC-80-10-A-P-A	188308	ADVC-80-10-I-P-A	
		15	188317	ADVC-80-15-A-P-A	188309	ADVC-80-15-I-P-A	
		20	188318	ADVC-80-20-A-P-A	188310	ADVC-80-20-I-P-A	
		25	188319	ADVC-80-25-A-P-A	188311	ADVC-80-25-I-P-A	
	100	10	188340	ADVC-100-10-A-P-A	188332	ADVC-100-10-I-P-A	
		15	188341	ADVC-100-15-A-P-A	188333	ADVC-100-15-I-P-A	
		20	188342	ADVC-100-20-A-P-A	188334	ADVC-100-20-I-P-A	
25		188343	ADVC-100-25-A-P-A	188335	ADVC-100-25-I-P-A		

Datasheet – Single-acting, without position sensing

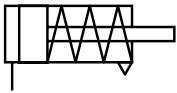

- $\varnothing$  - Diameter  
4 ... 100 mm
- | - Stroke length  
2.5 ... 25 mm

General technical data													
Piston $\varnothing$	4	6	10	12	16	20	25	32	40	50	63	80	100
Pneumatic connection	M3	M3	M5	M5	M5	M5	M5	G1/8	G1/8	G1/8	G1/8	G1/8	G1/4
Piston rod with female thread	-	-	-	■	■	■	■	■	■	■	■	■	■
Piston rod with male thread	■	■	■	■	■	■	■	■	■	■	■	■	■
Piston rod without thread	■	■	■	■	-	-	-	-	-	-	-	-	-
Operating medium	Compressed air to ISO 8573-1:2010 [7:4:4]												
Note on the operating/pilot medium	Lubricated operation possible (in which case lubricated operation will always be required)												
Design	Piston												
	Piston rod												
Cushioning	Elastic cushioning rings/plates at both ends												
Type of mounting	Via through-hole							Via through-hole					
	-							With accessories					
Mounting position	Any												

Operating conditions														
Piston $\varnothing$	4	6	10	12	16	20	25	32	40	50	63	80	100	
Operating pressure	[MPa]	0.25 ... 0.8		0.15 ... 0.8			0.15 ... 1			0.1 ... 1				
	[bar]	2.5 ... 8		1.5 ... 8			1.5 ... 10			1 ... 10				
	[psi]	36.25 ... 116		21.75 ... 116			21.75 ... 145			14.5 ... 145				
Ambient temperature	[°C]	-20 ... +80												
Corrosion resistance class CRC <sup>1)</sup>	1 - Low corrosion stress													

1) More information: [www.festo.com/x/topic/crc](http://www.festo.com/x/topic/crc)



## Datasheet – Single-acting, without position sensing

Forces [N] and impact energy [J]													
Piston $\varnothing$	4	6	10	12	16	20	25	32	40	50	63	80	100
Theoretical force at 0.6 MPa (6 bar, 87 psi), advancing	5	11	41	59	105	170	270	450	700	1120	1800	2900	4500
Theoretical force at 0.6 MPa (6 bar, 87 psi), retracting	1	3	3	4	5	10 <sup>1)</sup>	15	22	28	40	50	85	140
Max. impact energy in the end positions	0.003	0.005	0.03	0.06	0.10	0.14	0.18	0.26	0.36	0.60	0.64	0.90	1.20

1) AEVC-20-5-... = 5 N



### Note

The degree of friction depends on the mounting position and the type of load involved. Single-acting cylinders should as far as possible be operated without transverse loads.

Product weight [g]													
Stroke [mm]	Piston $\varnothing$												
	4	6	10	12	16	20	25	32	40	50	63	80	100
2.5	3	–	–	–	–	–	–	–	–	–	–	–	–
5	4.3	7.6	16	21	37	57	94	117	–	–	–	–	–
10	–	11	21	34	49	87	110	169	234	306	460	1150	2050
25	–	–	–	–	81	132	167	224	337	466	667	1354	2405

Moving mass [g]													
Stroke [mm]	Piston $\varnothing$												
	4	6	10	12	16	20	25	32	40	50	63	80	100
2.5	0.15	–	–	–	–	–	–	–	–	–	–	–	–
5	0.2	1	2	4.4	8	14	22	40	–	–	–	–	–
10	–	1.4	2.6	6.9	11	21	25	48	65	105	157	327	678
25	–	–	–	–	19	32	37	62	83	140	191	365	739

### Materials

Sectional view

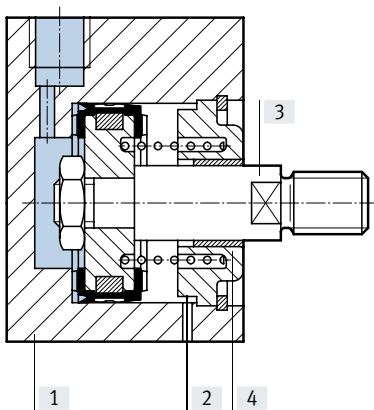

Short-stroke cylinder	$\varnothing 4$	$\varnothing 6 \dots 100$
[1] Cylinder barrel	Anodised aluminium	Anodised aluminium
[2] Cover	Anodised aluminium	Anodised aluminium
[3] Piston rod	Anodised aluminium	High-alloy steel
[4] Rod seal	NBR	Polyurethane
– Note on materials	RoHS-compliant	RoHS-compliant
– LABS (PWIS) conformity	VDMA24364-B1/B2-L	VDMA24364-B1/B2-L
– LABS (PWIS) criterion	Free of paint-wetting impairment substances to FN 942010	Free of paint-wetting impairment substances to FN 942010

Datasheet – Single-acting, without position sensing

Dimensions

Download CAD data → [www.festo.com](http://www.festo.com)

∅ 4 ... 25 mm

AEVC-...-I-P, piston rod with female thread

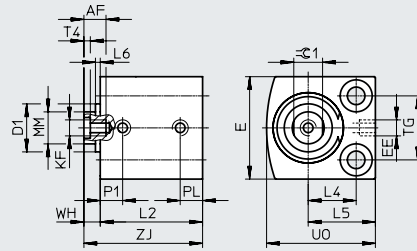

AEVC-...-A-P, piston rod with male thread

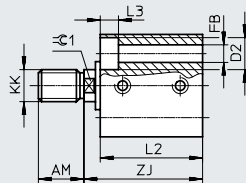

AEVC-...-P, piston rod without thread

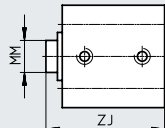

∅ 10 mm

The bearing cap can protrude by up to 0.65 mm depending on the tolerance position.

∅ 12 mm

The bearing cap can protrude by up to 0.35 mm depending on the tolerance position.

[1] No undercut with diameter 4/6/10

## Datasheet – Single-acting, without position sensing

∅ [mm]	Stroke [mm]	AF min.	AM -0.5	D1 ∅ max.	D2 ∅	E max.	EE	FB ∅	KF	KK	L2 +0.2	L3
4	2.5	-	6	-	3.3 <sup>+0.1</sup>	10	M3	1.8	-	M2	13	1.8
	5										15.5	
6	5	-	6	-	5 <sup>+0.1</sup>	13	M3	2.9	-	M3	16	2.9
	10										23.4	
10	5	-	8	7.5	5.8 <sup>+0.1</sup>	18	M5	3.4	-	M4	16	3.4
	10										23	
12	5	8	8	10.7	6 <sup>H13</sup>	20	M5	3.4	M3	M5	16	3.4
	10										27.5	
16	5	10	12	-	8 <sup>H13</sup>	25	M5	4.5	M4	M6	20	4.6
	10										27.5	
	25										47	
20	5	8	12	-	10 <sup>H13</sup>	32	M5	5.5	M5	M8	20	5.7
	10	12									30.5	
	25	48.5										
25	5	12	12	-	10 <sup>H13</sup>	38	M5	5.5	M5	M8	26.1	5.7
	10										31.1	
	25										50.2	

∅ [mm]	Stroke [mm]	L4	L5	L6 max.	MM ∅	PL	T4	TG ±0.1	UO max.	WH	ZJ ±0.8	≅1
4	2.5	4	6.5	-	2	3.2	-	5.8	10	1	14	-
	5										16.5	
6	5	6	9	-	3	3	-	7	14	1	17	-
	10										24.4	
10	5	8	11.5	0.7	4	5.5	-	11	19	1	17	-
	10										24	
12	5	9	13	0.4	6	6	1.5	13	22	1	17	-
	10										28.5	
16	5	11.5	16.5	-	8	6	2	15	27	1	21	7
	10										28.5	
	25										48	
20	5	15	21	-	10	7	2	20	34	1	21	9
	10										31.5	
	25										49.5	
25	5	15.5	21.5	-	10	6.5	2	26	37	1	27.1	9
	10										32.1	
	25										51.2	

Datasheet – Single-acting, without position sensing

Dimensions

Download CAD data → [www.festo.com](http://www.festo.com)

∅ 32 ... 100 mm

AEVC...-I-P, piston rod with female thread

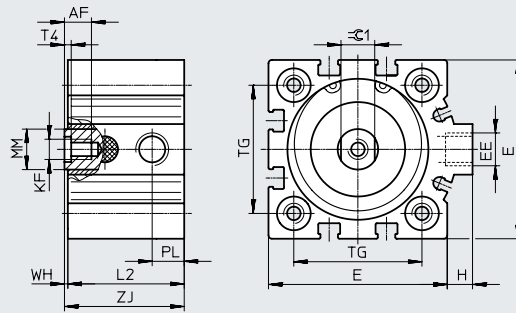

AEVC...-A-P \*\*, piston rod with male thread

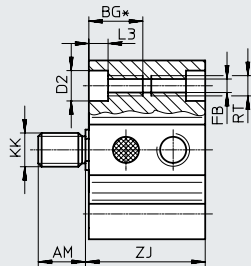

## Datasheet – Single-acting, without position sensing

∅	Stroke	AF	AM	BG*	D2 ∅ F9	E	EE	FB ∅	H	KF	KK
[mm]	[mm]	min.	-0.5	min.		max.					
32	5	12	14	21.7	9	45	G1/8	5.2	7	M6	M10x1.25
	10										
	25										
40	10	12	14	21.7	9	53.5	G1/8	5.2	7	M6	M10x1.25
	25										
50	10	16	16	22.8	11	63.5	G1/8	6.8	7	M8	M12x1.25
	25										
63	10	16	16	22.8	11	75	G1/8	6.8	7.5	M8	M12x1.25
	25										
80	10	20	22	25	14	93	G1/8	8.5	7	M10	M16x1.5
	25										
100	10	24	28	25	14	113	G1/4	8.5	13	M12	M20x1.5
	25										

∅	Stroke	L2	L3	MM ∅	PL	RT	T4	TG	WH	ZJ	≈C1
[mm]	[mm]	+0.2						±0.1		±0.8	
32	5	26	5.7	12	9.5	M6	2.6	32.5	1	27	10
	10	35								36	
	25	50								51	
40	10	34.5	5.7	12	9.5	M6	2.6	38	1	35.5	10
	25	54.5								55.5	
50	10	30.6	6.8	16	9.5	M8	3.3	46.5	0.5	31.1	13
	25	53								53.5	
63	10	35	6.8	16	11.5	M8	3.3	56.5	1	36	13
	25	57								58	
80	10	52	9	20	15	M10	4.7	72	1	53	17
	25	67								68	
100	10	59	9	25	19	M10	6.1	89	1	60	22
	25	74								75	

\* Continuous thread with shorter sizes

\*\* Nut for piston rod with external thread included in the scope of delivery.

Datasheet – Single-acting, without position sensing

Ordering data				
Type	Piston ø	Stroke	Piston rod without thread	
	[mm]	[mm]	Part no.	Type
	4	2.5	188050	AEVC-4-2.5-P
		5	188051	AEVC-4-5-P
	6	5	188058	AEVC-6-5-P
		10	188059	AEVC-6-10-P
	10	5	188070	AEVC-10-5-P
		10	188071	AEVC-10-10-P
	12	5	530566	AEVC-12-5-P
		10	530567	AEVC-12-10-P

Ordering data								
Type	Piston ø	Stroke	Piston rod with male thread		Piston rod with female thread			
			Part no.	Type	Part no.	Type		
	4	2.5	188052	AEVC-4-2.5-A-P	-			
		5	188053	AEVC-4-5-A-P				
	6	5	188062	AEVC-6-5-A-P				
		10	188063	AEVC-6-10-A-P				
	10	5	188074	AEVC-10-5-A-P				
		10	188075	AEVC-10-10-A-P				
	12	5	188086	AEVC-12-5-A-P			188082	AEVC-12-5-I-P
		10	188087	AEVC-12-10-A-P			188083	AEVC-12-10-I-P
	16	5	188105	AEVC-16-5-A-P			188099	AEVC-16-5-I-P
		10	188106	AEVC-16-10-A-P			188100	AEVC-16-10-I-P
		25	188107	AEVC-16-25-A-P			188101	AEVC-16-25-I-P
	20	5	188137	AEVC-20-5-A-P			188131	AEVC-20-5-I-P
		10	188138	AEVC-20-10-A-P			188132	AEVC-20-10-I-P
		25	188139	AEVC-20-25-A-P			188133	AEVC-20-25-I-P
	25	5	188169	AEVC-25-5-A-P			188163	AEVC-25-5-I-P
		10	188170	AEVC-25-10-A-P			188164	AEVC-25-10-I-P
25		188171	AEVC-25-25-A-P	188165	AEVC-25-25-I-P			

## Datasheet – Single-acting, without position sensing

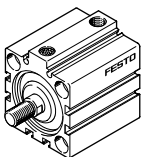
Ordering data						
Type	Piston ø [mm]	Stroke [mm]	Piston rod with male thread		Piston rod with female thread	
			Part no.	Type	Part no.	Type
	32	5	<b>188201</b>	<b>AEVC-32-5-A-P</b>	<b>188195</b>	<b>AEVC-32-5-I-P</b>
		10	<b>188202</b>	<b>AEVC-32-10-A-P</b>	<b>188196</b>	<b>AEVC-32-10-I-P</b>
		25	<b>188203</b>	<b>AEVC-32-25-A-P</b>	<b>188197</b>	<b>AEVC-32-25-I-P</b>
	40	10	<b>188230</b>	<b>AEVC-40-10-A-P</b>	<b>188226</b>	<b>AEVC-40-10-I-P</b>
		25	<b>188231</b>	<b>AEVC-40-25-A-P</b>	<b>188227</b>	<b>AEVC-40-25-I-P</b>
	50	10	<b>188258</b>	<b>AEVC-50-10-A-P</b>	<b>188254</b>	<b>AEVC-50-10-I-P</b>
		25	<b>188259</b>	<b>AEVC-50-25-A-P</b>	<b>188255</b>	<b>AEVC-50-25-I-P</b>
	63	10	<b>188282</b>	<b>AEVC-63-10-A-P</b>	<b>188278</b>	<b>AEVC-63-10-I-P</b>
		25	<b>188283</b>	<b>AEVC-63-25-A-P</b>	<b>188279</b>	<b>AEVC-63-25-I-P</b>
	80	10	<b>188306</b>	<b>AEVC-80-10-A-P</b>	<b>188302</b>	<b>AEVC-80-10-I-P</b>
		25	<b>188307</b>	<b>AEVC-80-25-A-P</b>	<b>188303</b>	<b>AEVC-80-25-I-P</b>
	100	10	<b>188330</b>	<b>AEVC-100-10-A-P</b>	<b>188326</b>	<b>AEVC-100-10-I-P</b>
		25	<b>188331</b>	<b>AEVC-100-25-A-P</b>	<b>188327</b>	<b>AEVC-100-25-I-P</b>

Datasheet – Single-acting, with position sensing

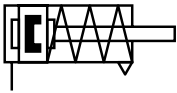

- Diameter  
6 ... 100 mm
- Stroke length  
2.5 ... 25 mm

General technical data												
Piston $\varnothing$	6	10	12	16	20	25	32	40	50	63	80	100
Pneumatic connection	M3	M5	M5	M5	M5	M5	G1/8	G1/8	G1/8	G1/8	G1/8	G1/4
Piston rod with female thread	–	–	■	■	■	■	■	■	■	■	■	■
Piston rod with male thread	■	■	■	■	■	■	■	■	■	■	■	■
Piston rod without thread	■	■	■	–	–	–	–	–	–	–	–	–
Operating medium	Compressed air to ISO 8573-1:2010 [7:4:4]											
Note on the operating/ pilot medium	Lubricated operation possible (in which case lubricated operation will always be required)											
Design	Piston											
	Piston rod											
Cushioning	Elastic cushioning rings/plates at both ends											
Position sensing	For proximity switch											
Type of mounting	Via through-hole						Via through-hole					
	–						With accessories					
Mounting position	Any											

Operating conditions												
Piston $\varnothing$	6	10	12	16	20	25	32	40	50	63	80	100
Operating pressure	[MPa]	0.25 ... 0.8	0.15 ... 0.8	0.15 ... 1			0.1 ... 1					
	[bar]	2.5 ... 8	1.5 ... 8	1.5 ... 10			1 ... 10					
	[psi]	36.25 ... 116	21.75 ... 116	21.75 ... 145			14.5 ... 145					
Ambient temperature	[°C]	–20 ... +80 (observe operating range of proximity switches)										
Corrosion resistance class CRC <sup>1)</sup>	1 - Low corrosion stress											

1) More information: [www.festo.com/x/topic/crc](http://www.festo.com/x/topic/crc)



## Datasheet – Single-acting, with position sensing

Forces [N] and impact energy [J]												
Piston $\varnothing$	6	10	12	16	20	25	32	40	50	63	80	100
Theoretical force at 0.6 MPa (6 bar, 87 psi), advancing	11	41	59	105	170	270	450	700	1120	1800	2900	4500
Theoretical force at 0.6 MPa (6 bar, 87 psi), retracting	3	3	4	5	10 <sup>1)</sup>	15	22	28	40	50	85	140
Max. impact energy in the end positions	0.005	0.03	0.06	0.10	0.14	0.18	0.26	0.36	0.60	0.64	0.90	1.20

1) AEVC-20-5-... = 5 N

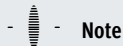
**Note**

The degree of friction depends on the mounting position and the type of load involved. Single-acting cylinders should as far as possible be operated without transverse loads.

Product weight [g]												
Stroke [mm]	Piston $\varnothing$											
	6	10	12	16	20	25	32	40	50	63	80	100
5	14	31	58	81	120	151	190	–	–	–	–	–
10	18	35	64	89	136	168	205	316	475	660	1210	2244
25	–	–	–	131	189	235	260	383	580	780	1367	2372

Moving mass [g]												
Stroke [mm]	Piston $\varnothing$											
	6	10	12	16	20	25	32	40	50	63	80	100
5	1.5	3	8.5	15	26	32	49	–	–	–	–	–
10	1.8	3.5	9.5	17	29	35	54	70	116	155	284	546
25	–	–	–	26	40	47	67	83	140	179	321	604

**Materials**

Sectional view

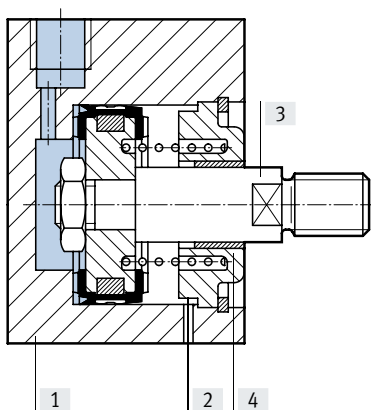

Short-stroke cylinder	
[1] Cylinder barrel	Anodised aluminium
[2] Cover	Anodised aluminium
[3] Piston rod	High-alloy steel
[4] Rod seal	Polyurethane
– Note on materials	RoHS-compliant
LABS (PWIS) conformity	VDMA24364-B1/B2-L
LABS (PWIS) criterion	Free of paint-wetting impairment substances to FN 942010

Datasheet – Single-acting, with position sensing

Dimensions

Download CAD data → [www.festo.com](http://www.festo.com)

∅ 6 ... 25 mm

AEVC...-I-P-A, piston rod with female thread

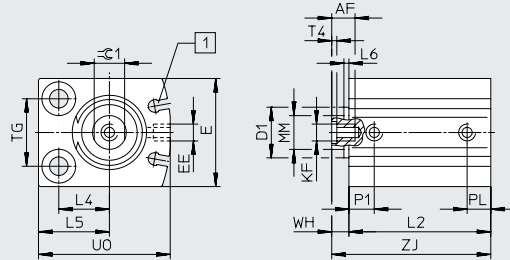

AEVC...-A-P-A, piston rod with male thread

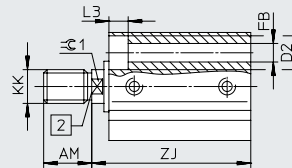

AEVC...-P-A, piston rod without thread

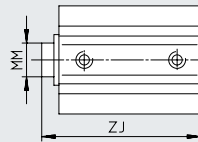

∅ 10 mm

The bearing cap can protrude by up to 0.65 mm depending on the tolerance position.

∅ 12 mm

The bearing cap can protrude by up to 0.35 mm depending on the tolerance position.

[1] No undercut with diameter 6/10

[2] Slot for proximity switch SME/SMT-10

## Datasheet – Single-acting, with position sensing

∅ [mm]	Stroke [mm]	AF min.	AM -0.5	D1 ∅ max.	D2 ∅	E max.	EE	FB ∅	KF	KK	L2 +0.2	L3
6	5	-	6	-	5 +0.1	16	M3	2.9	-	M3	25.5	2.9
	10										30.5	
10	5	-	8	7.5	5.8 +0.1	21	M5	3.4	-	M4	27	3.4
	10										32	
12	5	8	8	10.7	6 H13	24	M5	3.4	M3	M5	36	3.4
	10										41	
16	5	10	12	-	8 H13	28	M5	4.5	M4	M6	35	4.6
	10										40	
	25										59.5	
20	5	12	12	-	10 H13	32	M5	5.5	M5	M8	37	5.7
	10										42	
	25										60	
25	5	12	12	-	10 H13	38	M5	5.5	M5	M8	37	5.7
	10										42	
	25										61.1	

∅ [mm]	Stroke [mm]	L4	L5	L6 max.	MM ∅	PL	T4	TG ±0.1	U0 max.	WH	ZJ ±0.8	≅1
6	5	5	8	-	3	3	-	10	16	1	26.5	-
	10										31.5	
10	5	7	10.5	0.7	4	6	-	14	22	1.5	28.5	-
	10										33.5	
12	5	8	12	0.4	6	6	1.5	16	26	4	40	5
	10										45	
16	5	12	17	-	8	6	2	18	32	4	39	7
	10										44	
	25										63.5	
20	5	15	21	-	10	7	2	20	39	5	42	9
	10										47	
	25										65	
25	5	15.5	21.5	-	10	6	2	26	42	5	42	9
	10										47	
	25										66.1	

Datasheet – Single-acting, with position sensing

Dimensions

Download CAD data → [www.festo.com](http://www.festo.com)

∅ 32 ... 100 mm

AEVC...-I-P, piston rod with female thread

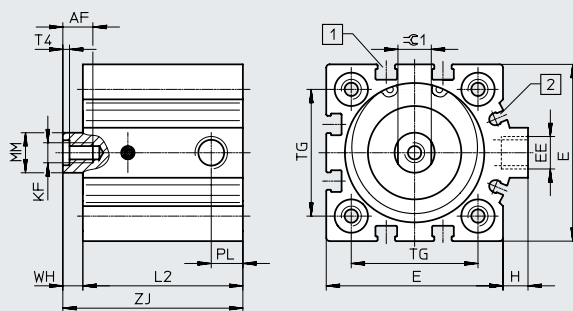

AEVC...-A-P\*\*, piston rod with male thread

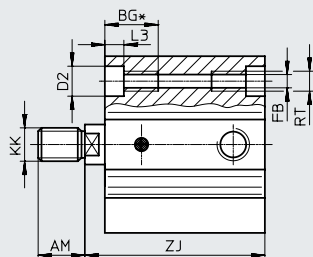

∅	Stroke [mm]	AF min.	AM -0.5	BG* min.	D2 ∅ F9	E max.	EE	FB ∅	H	KF	KK	L2 +0.2	L3	MM ∅	PL	RT	T4	TG ±0.1	WH	ZJ ±0.8	⊖C1
32	5	12	14	21.7	9	45	G1/8	5.2	7	M6	M10x1.25	38	5.7	12	8.5	M6	2.6	32.5	6	44	10
	43											49									
	58											64									
40	10	12	14	21.7	9	53.5	G1/8	5.2	7	M6	M10x1.25	48	5.7	12	9.5	M6	2.6	38	6	54	10
	63											69									
50	10	16	16	22.8	11	63.5	G1/8	6.8	7	M8	M12x1.25	50	6.8	16	9.5	M8	3.3	46.5	8	58	13
	65											73									
63	10	16	16	22.8	11	75	G1/8	6.8	7.5	M8	M12x1.25	51	6.8	16	10.5	M8	3.3	56.5	8	59	13
	66											74									
80	10	20	22	25	14	93	G1/8	8.5	7	M10	M16x1.5	59	9	20	8.5	M10	4.7	72	8	67	17
	74											82									
100	10	24	28	25	14	113	G1/4	8.5	13	M12	M20x1.5	68	9	25	10.5	M10	6.1	89	10	78	22
	83											93									

\* Continuous thread with shorter sizes

\*\* Nut for piston rod with external thread included in the scope of delivery.

## Datasheet – Single-acting, with position sensing

Ordering data								
Type	Piston ø [mm]	Stroke [mm]	Piston rod with male thread		Piston rod with female thread		Piston rod without thread	
			Part no.	Type	Part no.	Type	Part no.	Type
	6	5	188060	AEVC-6-5-A-P-A	–		188056	AEVC-6-5-P-A
		10	188061	AEVC-6-10-A-P-A			188057	AEVC-6-10-P-A
	10	5	188072	AEVC-10-5-A-P-A	–		188068	AEVC-10-5-P-A
		10	188073	AEVC-10-10-A-P-A			188069	AEVC-10-10-P-A
	12	5	188084	AEVC-12-5-A-P-A	188080	AEVC-12-5-I-P-A	530570	AEVC-12-5-P-A
		10	188085	AEVC-12-10-A-P-A	188081	AEVC-12-10-I-P-A	530571	AEVC-12-10-P-A
	16	5	188102	AEVC-16-5-A-P-A	188096	AEVC-16-5-I-P-A	–	
		10	188103	AEVC-16-10-A-P-A	188097	AEVC-16-10-I-P-A		
		25	188104	AEVC-16-25-A-P-A	188098	AEVC-16-25-I-P-A		
	20	5	188134	AEVC-20-5-A-P-A	188128	AEVC-20-5-I-P-A	–	
		10	188135	AEVC-20-10-A-P-A	188129	AEVC-20-10-I-P-A		
		25	188136	AEVC-20-25-A-P-A	188130	AEVC-20-25-I-P-A		
	25	5	188166	AEVC-25-5-A-P-A	188160	AEVC-25-5-I-P-A	–	
		10	188167	AEVC-25-10-A-P-A	188161	AEVC-25-10-I-P-A		
		25	188168	AEVC-25-25-A-P-A	188162	AEVC-25-25-I-P-A		

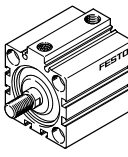
Ordering data								
Type	Piston ø [mm]	Stroke [mm]	Piston rod with male thread		Piston rod with female thread			
			Part no.	Type	Part no.	Type		
	32	5	188198	AEVC-32-5-A-P-A	188192	AEVC-32-5-I-P-A		
		10	188199	AEVC-32-10-A-P-A	188193	AEVC-32-10-I-P-A		
		25	188200	AEVC-32-25-A-P-A	188194	AEVC-32-25-I-P-A		
	40	10	188228	AEVC-40-10-A-P-A	188224	AEVC-40-10-I-P-A		
		25	188229	AEVC-40-25-A-P-A	188225	AEVC-40-25-I-P-A		
	50	10	188256	AEVC-50-10-A-P-A	188252	AEVC-50-10-I-P-A		
		25	188257	AEVC-50-25-A-P-A	188253	AEVC-50-25-I-P-A		
	63	10	188280	AEVC-63-10-A-P-A	188276	AEVC-63-10-I-P-A		
		25	188281	AEVC-63-25-A-P-A	188277	AEVC-63-25-I-P-A		
	80	10	188304	AEVC-80-10-A-P-A	188300	AEVC-80-10-I-P-A		
		25	188305	AEVC-80-25-A-P-A	188301	AEVC-80-25-I-P-A		
	100	10	188328	AEVC-100-10-A-P-A	188324	AEVC-100-10-I-P-A		
		25	188329	AEVC-100-25-A-P-A	188325	AEVC-100-25-I-P-A		

## Accessories

### Multi-position kit DPNC

Material:

Flange:

Wrought aluminium alloy

Threaded pins, hex nuts:

Galvanised steel

RoHS-compliant

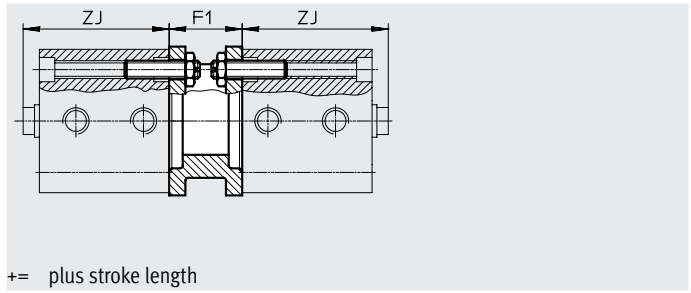

Dimensions and ordering data									
For $\varnothing$ [mm]	Stroke [mm]	F1	ZJ				Weight [g]	Part no.	Type
			Without position sensing		With position sensing				
			ADVC	AEVC	ADVC	AEVC			
32	5	27	35	22	39	39	292	174418	DPNC-32
	10, 15, 20, 25			26					
40	5, 10	27	35.5	25.5	44	44	410	174419	DPNC-40
	15, 20, 25			30.5					
50	10	32	36	21.1	46	48	335	174420	DPNC-50
	15, 20, 25			28.5					
63	10	28	43	26	49	49	390	174421	DPNC-63
	15, 20, 25			33					
80	10, 15, 20, 25	38	48	43	57	57	847	174422	DPNC-80
100	10, 15, 20, 25	38	59	50	68	68	1200	174423	DPNC-100

### Connecting two cylinders with identical piston diameters to form a 3- or 4-position cylinder

A 3- or 4-position cylinder consists of two separate cylinders whose piston rods advance in opposite directions. This means that, depending on actuation and stroke configuration, this type of cylinder can assume up to four positions. In each case the cylinder is moved precisely against a stop.

Note that when one end of the piston rod is fixed, the cylinder barrel executes the movement. The connections to the cylinder must therefore be flexible.

#### To achieve 3 positions

Two cylinders with the same stroke length must be connected to each other.

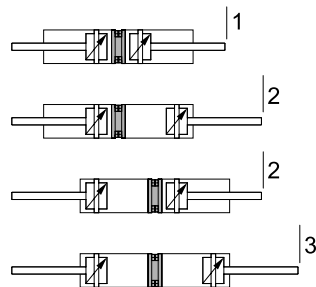

#### To achieve 4 positions

Two cylinders with different stroke lengths must be connected to each other.

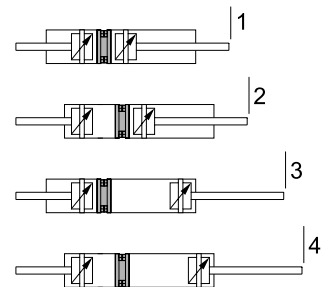

## Accessories

## Foot mounting HNC

Material:  
Galvanised steel

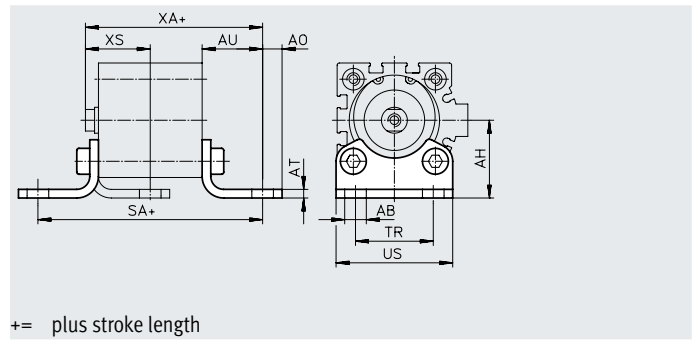

## Dimensions and ordering data

For $\varnothing$ [mm]	Stroke [mm]	AB $\varnothing$	AH	AO	AT	AU	SA				TR	US
							Without position sensing		With position sensing			
							ADVC	AEVC	ADVC	AEVC		
32	5	7	32	6.5	4	24	77	69	81	81	32	45
							73					
40	5, 10	10	36	9	4	28	85.5	80.5	94	94	36	54
	15, 20, 25							85.5				
50	10	10	45	9.5	5	32	92	84.6	102	104	45	64
	15, 20, 25							92				
63	10	10	50	12.5	5	32	99	89	105	105	50	75
	15, 20, 25							96				
80	10, 15, 20, 25	12	63	15	6	41	122	124	131	131	63	93
100	10, 15, 20, 25	14.5	71	17.5	6	41	131	131	140	140	75	110

For $\varnothing$ [mm]	Stroke [mm]	XA				XS				CRC <sup>1)</sup>	Weight [g]	Part no.	Type
		Without position sensing		With position sensing		Without position sensing		With position sensing					
		ADVC	AEVC	ADVC	AEVC	ADVC	AEVC	ADVC	AEVC				
32	5	59	46	63	63	26	21	26	26	2	144	174369	HNC-32
	50												
40	5, 10	63.5	53.5	72	72	30	25	30	30	2	193	174370	HNC-40
	15, 20, 25		58.5										
50	10	68	53.1	78	80	35	27.5	35	35	2	353	174371	HNC-50
	15, 20, 25		60.5										
63	10	75	58	81	81	35	28	35	35	2	436	174372	HNC-63
	15, 20, 25		65										
80	10, 15, 20, 25	89	84	98	98	43	36	43	43	2	829	174373	HNC-80
100	10, 15, 20, 25	100	91	109	109	45	36	45	45	2	1009	174374	HNC-100

1) More information: [www.festo.com/x/topic/crc](http://www.festo.com/x/topic/crc)

-  - Note

Screws with special lengths are required to fit diameters 80 mm and 100 mm → page 50

## Accessories

### Flange mounting FNC

Material:  
Galvanised steel  
RoHS-compliant

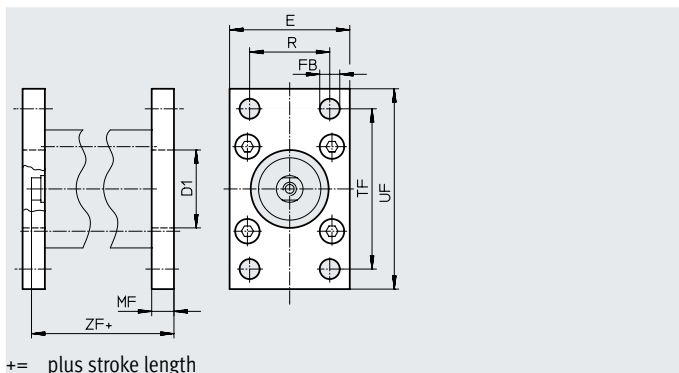
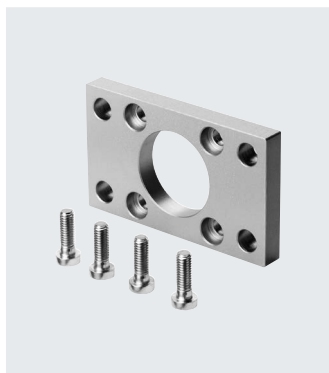

#### Dimensions and ordering data

For $\varnothing$ [mm]	Stroke [mm]	D1 $\varnothing$ H11	E	FB $\varnothing$ H13	MF	R	TF	UF
32	5	30	45	7	10	32	64	80
	10, 15, 20, 25							
40	5, 10	35	54	9	10	36	72	90
	15, 20, 25							
50	10	40	65	9	12	45	90	110
	15, 20, 25							
63	10	45	75	9	12	50	100	120
	15, 20, 25							
80	10, 15, 20, 25	45	93	12	16	63	126	150
100	10, 15, 20, 25	55	110	14	16	75	150	175

For $\varnothing$ [mm]	Stroke [mm]	ZF				CRC <sup>1)</sup>	Weight [g]	Part no.	Type
		Without position sensing		With position sensing					
		ADVC	AEVC	ADVC	AEVC				
32	5	45	32	49	49	1	221	174376	FNC-32
	10, 15, 20, 25		36						
40	5, 10	45.5	35.5	54	54	1	291	174377	FNC-40
	15, 20, 25		40.5						
50	10	48	33.5	58	60	1	536	174378	FNC-50
	15, 20, 25		40.5						
63	10	55	38	61	61	1	679	174379	FNC-63
	15, 20, 25		45						
80	10, 15, 20, 25	64	59	73	73	1	1495	174380	FNC-80
100	10, 15, 20, 25	75	66	84	84	1	2041	174381	FNC-100

1) More information: [www.festo.com/x/topic/crc](http://www.festo.com/x/topic/crc)

- **Note**

Screws with special lengths are required to fit diameters 80 mm and 100 mm → page 50



## Accessories

## Trunnion flange ZNCF

Material:  
Cast stainless steel  
RoHS-compliant

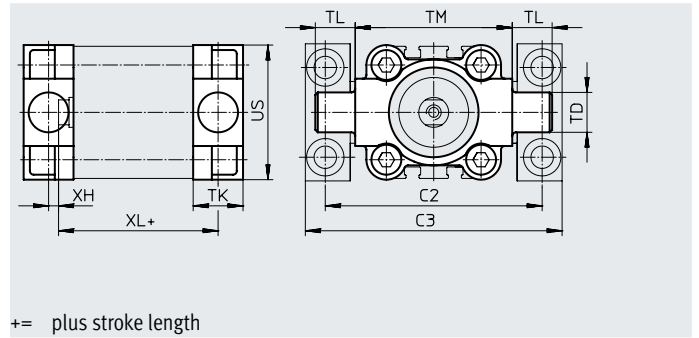

## Dimensions and ordering data

For $\varnothing$ [mm]	Stroke [mm]	C2)	C3)	D1 $\varnothing$ H11	TD $\varnothing$ e9	TK	TL	TM	US	XH
32	5	71	86	30	12	16	12	50	45	2
	10, 15, 20, 25									
40	5, 10	87	105	35	16	20	16	63	54	4
	15, 20, 25									
50	10	99	117	40	16	24	16	75	64	4
	15, 20, 25									
63	10	116	136	45	20	24	20	90	75	4
	15, 20, 25									
80	10, 15, 20, 25	136	156	45	20	28	20	110	93	6
100	10, 15, 20, 25	164	189	55	25	38	25	132	110	9

For $\varnothing$ [mm]	Stroke [mm]	XL				CRC <sup>1)</sup>	Weight [g]	Part no.	Type
		Without position sensing		With position sensing					
		ADVC	AEVC	ADVC	AEVC				
32	5	43	30	47	47	2	150	174411	ZNCF-32
	10, 15, 20, 25		34						
40	5, 10	45.5	35.5	54	54	2	285	174412	ZNCF-40
	15, 20, 25		40.5						
50	10	48	33.1	58	60	2	473	174413	ZNCF-50
	15, 20, 25		40.5						
63	10	55	38	61	61	2	687	174414	ZNCF-63
	15, 20, 25		45						
80	10, 15, 20, 25	62	57	71	71	2	1296	174415	ZNCF-80
100	10, 15, 20, 25	78	69	87	87	2	2254	174416	ZNCF-100

1) More information: [www.festo.com/x/topic/crc](http://www.festo.com/x/topic/crc)

-  - Note

Screws with special lengths are required to fit diameters 80 mm and 100 mm → page 50

## Accessories

### Trunnion support LNZZ

Material:  
 Trunnion support: Anodised aluminium  
 Plain bearing: Plastic  
 RoHS-compliant

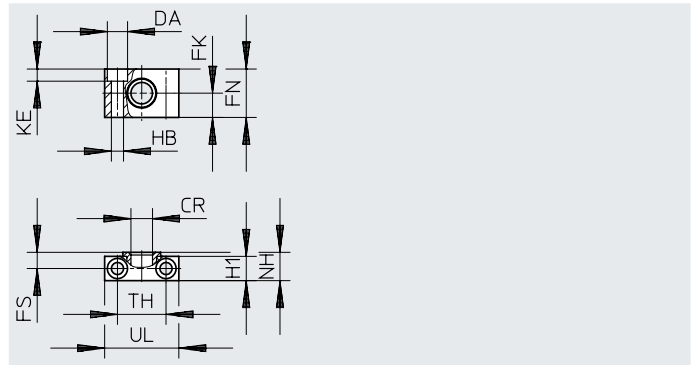

#### Dimensions and ordering data

For $\varnothing$ [mm]	CR $\varnothing$ D11	DA $\varnothing$ H13	FK $\varnothing$ $\pm 0.1$	FN	FS	H1	HB $\varnothing$ H13	KE	NH	TH $\pm 0.2$	UL	CRC <sup>1)</sup>	Weight [g]	Part no.	Type
32	12	11	15	30	10.5	15	6.6	6.8	18	32	46	2	83	<b>32959</b>	<b>LNZZ-32</b>
40, 50	16	15	18	36	12	18	9	9	21	36	55	2	129	<b>32960</b>	<b>LNZZ-4 0/50</b>
63, 80	20	18	20	40	13	20	11	11	23	42	65	2	178	<b>32961</b>	<b>LNZZ-6 3/80</b>
100	25	20	25	50	16	24.5	14	13	28.5	50	75	2	306	<b>32962</b>	<b>LNZZ-10 0/125</b>

1) More information: [www.festo.com/x/topic/crc](http://www.festo.com/x/topic/crc)

## Accessories

### Swivel flange SNC

Material:  
Die-cast aluminium  
RoHS-compliant

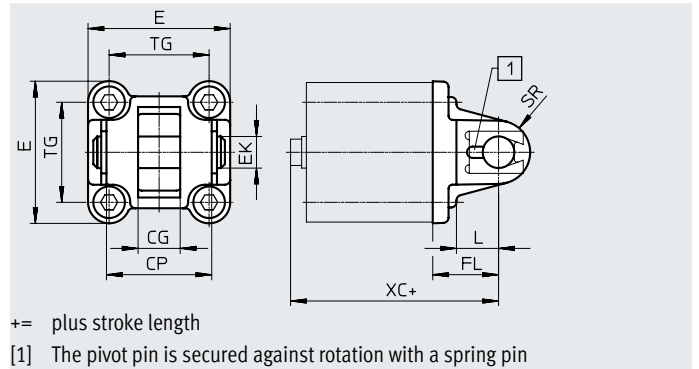

#### Dimensions and ordering data

For $\varnothing$	Stroke	CG	CP	EK	FL	L	SR
[mm]	[mm]	H14	h14	$\varnothing$ h9	$\pm 0.2$		
32	5	14	34	10	22	13	10
	10, 15, 20, 25						
40	5, 10	16	40	12	25	16	12
	15, 20, 25						
50	10	21	45	16	27	16	12
	15, 20, 25						
63	10	21	51	16	32	21	16
	15, 20, 25						
80	10, 15, 20, 25	25	65	20	36	22	16
100	10, 15, 20, 25	25	75	20	41	27	20

For $\varnothing$	Stroke	XC				CRC <sup>1)</sup>	Weight	Part no.	Type
		Without position sensing		With position sensing					
[mm]	[mm]	ADVC	AEVC	ADVC	AEVC		[g]		
32	5	57	44	61	61	1	93	174383	SNC-32
	10, 15, 20, 25		48						
40	5, 10	60.5	50.5	69	69	1	140	174384	SNC-40
	15, 20, 25		55.5						
50	10	63	48.1	73	75	1	234	174385	SNC-50
	15, 20, 25		55.5						
63	10	75	58	81	81	1	331	174386	SNC-63
	15, 20, 25		65						
80	10, 15, 20, 25	84	79	93	93	1	618	174387	SNC-80
100	10, 15, 20, 25	100	91	109	109	1	865	174388	SNC-100

1) More information: [www.festo.com/x/topic/crc](http://www.festo.com/x/topic/crc)

#### - Note

Screws with special lengths are required to fit diameters 80 mm and 100 mm → page 50

## Accessories

### Swivel flange SNCB

Material:  
Die-cast aluminium  
RoHS-compliant

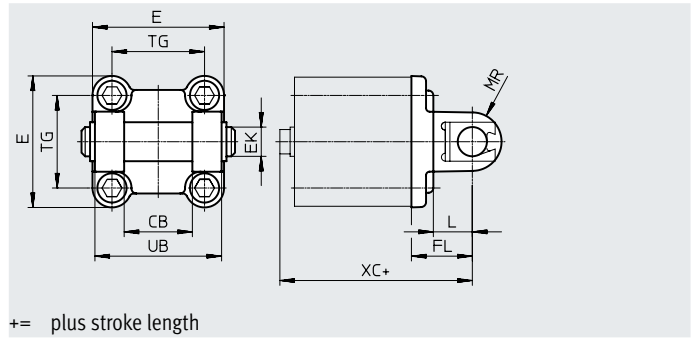

+ = plus stroke length

#### Dimensions and ordering data

For $\varnothing$	Stroke	CB	EK	FL	L	MR	UB
[mm]	[mm]	H14	$\varnothing$ e8	$\pm 0.2$			h14
32	5	26	10	22	13	8.5	45
	10, 15, 20, 25						
40	5, 10	28	12	25	16	12	52
	15, 20, 25						
50	10	32	12	27	16	12	60
	15, 20, 25						
63	10	40	16	32	21	16	70
	15, 20, 25						
80	10, 15, 20, 25	50	16	36	22	16	90
100	10, 15, 20, 25	60	20	41	27	20	110

For $\varnothing$	Stroke	XC				CRC <sup>1)</sup>	Weight	Part no.	Type
		Without position sensing		With position sensing					
[mm]	[mm]	ADVC	AEVC	ADVC	AEVC		[g]		
32	5	57	44	61	61	1	103	174390	SNCB-32
	10, 15, 20, 25		48						
40	5, 10	60.5	50.5	69	69	1	155	174391	SNCB-40
	15, 20, 25		55.5						
50	10	63	48.1	73	75	1	232	174392	SNCB-50
	15, 20, 25		55.5						
63	10	75	58	81	81	1	375	174393	SNCB-63
	15, 20, 25		65						
80	10, 15, 20, 25	84	79	93	93	1	636	174394	SNCB-80
100	10, 15, 20, 25	100	91	109	109	1	1035	174395	SNCB-100

1) More information: [www.festo.com/x/topic/crc](http://www.festo.com/x/topic/crc)

#### Note

Screws with special lengths are required to fit diameters 80 mm and 100 mm → page 50

## Accessories

## Swivel flange SNCS

Material:

SNCS 32 ... 50:

Die-cast aluminium

SNCS 63 ... 100:

Wrought aluminium alloy

RoHS-compliant

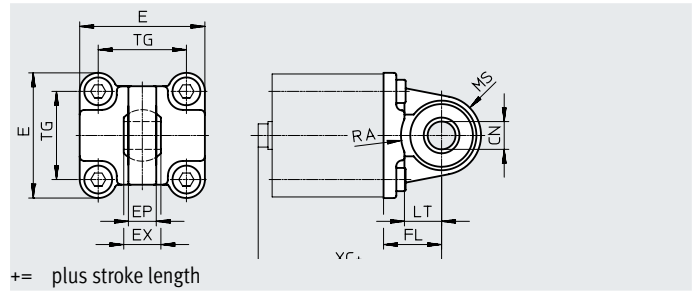
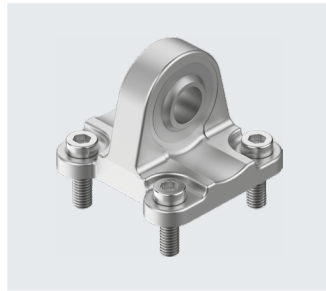

## Dimensions and ordering data

For $\varnothing$	Stroke	CN $\varnothing$	E	EP $\pm 0.2$	EX	FL $\pm 0.2$	LT	MS	RA $+1$	TG
[mm]	[mm]									
32	5	$10^{+0.013}$	$45^{+0.2/-0.5}$	10.5	14	22	13	$15^{+0.5}$	14.5	32.5
	10, 15, 20, 25									
40	5, 10	$12^{+0.015}$	$54_{-0.5}$	12	16	25	16	$17^{+0.5}$	17.5	38
	15, 20, 25									
50	10	$16^{+0.015}$	$64_{-0.6}$	15	21	27	16	$20^{+0.5}$	18.5	46.5
	15, 20, 25									
63	10	$16^{+0.015}$	$74.5 \pm 0.5$	15	21	32	21	$23_{-0.5}$	23	56.5
	15, 20, 25									
80	10, 15, 20, 25	$20^{+0.018}$	$92.2 \pm 0.8$	18	25	36	22	$28_{-0.5}$	25	72
100	10, 15, 20, 25	$20^{+0.018}$	$109^{+1/-0.7}$	18	25	41	27	$30 \pm 0.5$	95	89

For $\varnothing$	Stroke	XC				CRC <sup>1)</sup>	Weight [g]	Part no.	Type
		Without position sensing		With position sensing					
[mm]	[mm]	ADVC	AEVC	ADVC	AEVC				
32	5	57	44	61	61	1	86	174397	SNCS-32
	10, 15, 20, 25		48						
40	5, 10	60.5	50.5	69	69	1	122	174398	SNCS-40
	15, 20, 25		55.5						
50	10	63	48.1	73	75	1	216	174399	SNCS-50
	15, 20, 25		55.5						
63	10	75	58	81	81	2	281	174400	SNCS-63
	15, 20, 25		65						
80	10, 15, 20, 25	84	79	93	93	2	557	174401	SNCS-80
100	10, 15, 20, 25	100	91	109	109	2	683	174402	SNCS-100

1) More information: [www.festo.com/x/topic/crc](http://www.festo.com/x/topic/crc)

## Note

Screws with special lengths are required to fit diameters 80 mm and 100 mm → page 50

## Accessories

### Swivel flange SNCL

Material:  
Die-cast aluminium  
RoHS-compliant

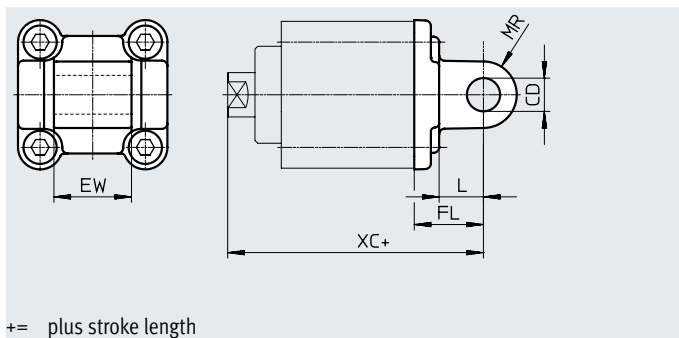

+ = plus stroke length

#### Dimensions and ordering data

For $\varnothing$ [mm]	Stroke [mm]	CD $\varnothing$ H9	EW -0.2/-0.6	FL $\pm 0.2$	L	MR
32	5	10	26	22	13	10
	10, 15, 20, 25					
40	5, 10	12	28	25	16	12
	15, 20, 25					
50	10	12	32	27	16	12
	15, 20, 25					
63	10	16	40	32	21	16
	15, 20, 25					
80	10, 15, 20, 25	16	50	36	22	16
100	10, 15, 20, 25	20	60	41	27	20

For $\varnothing$ [mm]	Stroke [mm]	XC				CRC <sup>1)</sup>	Weight [g]	Part no.	Type
		Without position sensing		With position sensing					
		ADVC	AEVC	ADVC	AEVC				
32	5	57	44	61	61	1	71	174404	SNCL-32
	10, 15, 20, 25		48						
40	5, 10	60.5	50.5	69	69	1	95	174405	SNCL-40
	15, 20, 25		55.5						
50	10	63	48.1	73	75	1	158	174406	SNCL-50
	15, 20, 25		55.5						
63	10	75	58	81	81	1	225	174407	SNCL-63
	15, 20, 25		65						
80	10, 15, 20, 25	84	79	93	93	1	436	174408	SNCL-80
100	10, 15, 20, 25	100	91	109	109	1	655	174409	SNCL-100

1) More information: [www.festo.com/x/topic/crc](http://www.festo.com/x/topic/crc)

#### - - Note



Screws with special lengths are required to fit diameters 80 mm and 100 mm → page 50

## Accessories

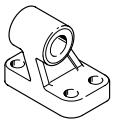
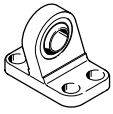
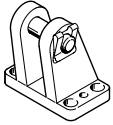
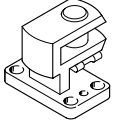
## Ordering data – Mounting components

Designation	For $\varnothing$	Part no.	Type
<b>Clevis foot LNG</b>			
	32	33890	LNG-32
	40	33891	LNG-40
	50	33892	LNG-50
	63	33893	LNG-63
	80	33894	LNG-80
	100	33895	LNG-100
<b>Clevis foot LSNG</b>			
	32	31740	LSNG-32
	40	31741	LSNG-40
	50	31742	LSNG-50
	63	31743	LSNG-63
	80	31744	LSNG-80
	100	31745	LSNG-100
<b>Clevis foot LBG on swivel flange SNCS</b>			
	32	31761	LBG-32
	40	31762	LBG-40
	50	31763	LBG-50
	63	31764	LBG-63
	80	31765	LBG-80
	100	31766	LBG-100
<b>Right angle clevis foot LQG</b>			
	32, 40	31768	LQG-32
	50, 63	31769	LQG-40
	80	31770	LQG-50
		31771	LQG-63
	100	31772	LQG-80
31773		LQG-100	

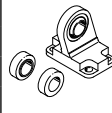
Datasheets → Internet: clevis foot

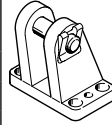
Designation	For $\varnothing$	Part no.	Type
<b>Clevis foot LSN</b>			
	32	5561	LSN-32
	40	5562	LSN-40
	50	5563	LSN-50
	63	5564	LSN-63
	80	5565	LSN-80
	100	5566	LSN-100
<b>Clevis foot LSNSG</b>			
	32	31747	LSNSG-32
	40	31748	LSNSG-40
	50	31749	LSNSG-50
	63	31750	LSNSG-63
	80	31751	LSNSG-80
	100	31752	LSNSG-100
<b>Clevis foot LBG on rod eye SGS</b>			
	32, 40	31761	LBG-32
	50, 63	31762	LBG-40
		31764	LBG-63
	80	31763	LBG-50
		31765	LBG-80
	100	31766	LBG-100

Accessories

Ordering data – Piston rod attachments

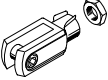
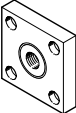

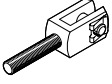
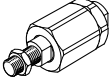

Designation	For ø	Part no.	Type
<b>Rod eye SGS</b>			
	10	9253	SGS-M4
	16	9254	SGS-M6
	20	9255	SGS-M8
	25		
	32		
	40	9261	SGS-M10x1.25
	50		
	63	9262	SGS-M12x1.25
	80		
	100	9263	SGS-M16x1.5
	9264	SGS-M20x1.5	
<b>Rod clevis SG</b>			
	10	6532	SG-M4
	12	-	-
	16	3110	SG-M6
	20	3111	SG-M8
	25		
	32	6144	SG-M10x1.25
	40		
	50	6145	SG-M12x1.25
	63		
	80	6146	SG-M16x1.5
100	6147	SG-M20x1.5	
	<b>Coupling piece KSG</b>		
	32	32963	KSG-M10x1.25
	40		
	50	32964	KSG-M12x1.25
	63		
	80	32965	KSG-M16x1.5
100	32966	KSG-M20x1.5	

Datasheets → Internet: piston rod attachment

Designation	For ø	Part no.	Type
<b>Rod clevis SGA</b>			
	32	-	
	40		
	50		
	63		
	32		
	40		
	50	10767	SGA-M12x1.25
	63		
	80	10768	SGA-M16x1.5
	100	10769	SGA-M20x1.5
<b>Self-aligning rod coupler FK</b>			
	10	6528	FK-M4
	12	30984	FK-M5
	16	2061	FK-M6
	20	2062	FK-M8
	25		
	32	6140	FK-M10x1.25
	40		
	50	6141	FK-M12x1.25
	63		
	80	6142	FK-M16x1.5
100	6143	FK-M20x1.5	



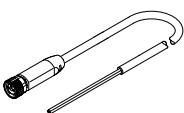
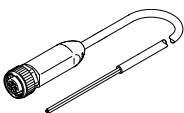

## Accessories

Ordering data – Proximity switch for T-slot, magneto-resistive							Datasheets → Internet: smt
	Type of mounting	Switching output	Electrical connection	Cable length [m]	Part no.	Type	
<b>N/O</b>							
	Inserted in the slot from above, flush with the cylinder profile, short design	PNP	Cable, 3-core	2.5	574335	SMT-8M-A-PS-24V-E-2.5-OE	
			Plug M8x1, 3-pin	0.3	574334	SMT-8M-A-PS-24V-E-0.3-M8D	
			1x M12 plug, 3-pin	0.3	574337	SMT-8M-A-PS-24V-E-0.3-M12	
		NPN	Cable, 3-core	2.5	574338	SMT-8M-A-NS-24V-E-2.5-OE	
			1x M8 plug, 3-pin	0.3	574339	SMT-8M-A-NS-24V-E-0.3-M8D	
<b>N/C</b>							
	Inserted in the slot from above, flush with the cylinder profile, short design	PNP	Cable, 3-core	7.5	574340	SMT-8M-A-PO-24V-E-7.5-OE	
<b>Ordering data – Proximity switch for T-slot, magnetic reed</b> <th>Datasheets → Internet: sme</th>							Datasheets → Internet: sme
	Type of mounting	Switching output	Electrical connection	Cable length [m]	Part no.	Type	
<b>N/O</b>							
	Inserted in the slot from above, flush with the cylinder profile	Contacting	Cable, 3-core	2.5	543862	SME-8M-DS-24V-K-2.5-OE	
				5.0	543863	SME-8M-DS-24V-K-5.0-OE	
			Cable, 2-core	2.5	543872	SME-8M-ZS-24V-K-2.5-OE	
				Plug M8x1, 3-pin	0.3	543861	SME-8M-DS-24V-K-0.3-M8D
<b>N/C</b>							
	Inserted in the slot lengthwise, flush with the cylinder profile	Contacting	Cable, 3-core	7.5	160251	SME-8-O-K-LED-24	
<b>Ordering data – Proximity switch for C-slot, magneto-resistive</b> <th>Datasheets → Internet: smt</th>							Datasheets → Internet: smt
	Type of mounting	Switching output	Electrical connection, Outlet direction of connection	Cable length [m]	Part no.	Type	
<b>N/O</b>							
	Inserted in the slot from above	PNP	Plug M8x1, 3-pin, in-line	0.3	551375	SMT-10M-PS-24V-E-0.3-L-M8D	
			Cable, 3-core, lengthwise	2.5	551373	SMT-10M-PS-24V-E-2.5-L-OE	
<b>Connecting cables NEBA, straight, M8 connection</b> <td></td>							
	Electrical connection 1, connection technology	Electrical connection 2, connection technology	Electrical connection 2, number of pins/cores	Cable length	Part no.	Type	
	M8x1 A-coded to EN 61076-2-104	Open end	3	2.5 m	8078223	NEBA-M8G3-U-2.5-N-LE3	
				5 m	8078224	NEBA-M8G3-U-5-N-LE3	
<b>Connecting cables NEBA, straight, M12 connection</b> <td></td>							
	Electrical connection 1, connection technology	Electrical connection 2, connection technology	Electrical connection 2, number of pins/cores	Cable length	Part no.	Type	
	M12x1 A-coded to EN61076-2-101	Open end	3	2.5 m	8078236	NEBA-M12G5-U-2.5-N-LE3	
				5 m	8078237	NEBA-M12G5-U-5-N-LE3	

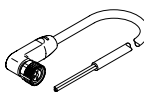
## Accessories

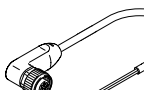
Connecting cables NEBA, angled, M8 connection						
	Electrical connection 1, connection technology	Electrical connection 2, connection technology	Electrical connection 2, number of pins/cores	Cable length	Part no.	Type
	M8x1 A-coded to EN 61076-2-104	Open end	3	2.5 m	8078230	NEBA-M8W3-U-2.5-N-LE3
				5 m	8078231	NEBA-M8W3-U-5-N-LE3

Connecting cables NEBA, angled, M12 connection						
	Electrical connection 1, connection technology	Electrical connection 2, connection technology	Electrical connection 2, number of pins/cores	Cable length	Part no.	Type
	M12x1 A-coded to EN61076-2-101	Open end	3	2.5 m	8078245	NEBA-M12W5-U-2.5-N-LE3
				5 m	8078246	NEBA-M12W5-U-5-N-LE3

Ordering data – Slot cover for T-slot				
	Mounting	Length	Part no.	Type
	Insertable	2x 0.5 m	151680	ABP-5-S

Ordering data – One-way flow control valves					Datasheets → Internet: grl		
	Connection Thread	For tubing O.D.	Material	Part no.	Type		
<b>For exhaust air</b>							
	M3	3	Metal design	175041	GRLA-M3-QS-3		
		M5		3	193137	GRLA-M5-QS-3-D	
				4	193138	GRLA-M5-QS-4-D	
				6	193139	GRLA-M5-QS-6-D	
	G1/8	3		193142	GRLA-1/8-QS-3-D		
		4		193143	GRLA-1/8-QS-4-D		
		6		193144	GRLA-1/8-QS-6-D		
		8		193145	GRLA-1/8-QS-8-D		
	G1/4	6		193146	GRLA-1/4-QS-6-D		
		8		193147	GRLA-1/4-QS-8-D		
		10		193148	GRLA-1/4-QS-10-D		

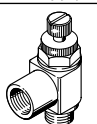
<b>For supply air</b>							
	M3	3	Metal design	175043	GRLZ-M3-QS-3		
		M5		3	193153	GRLZ-M5-QS-3-D	
				4	193154	GRLZ-M5-QS-4-D	
				6	193155	GRLZ-M5-QS-6-D	
	G1/8	3		193156	GRLZ-1/8-QS-3-D		
		4		193157	GRLZ-1/8-QS-4-D		
		6		193158	GRLZ-1/8-QS-6-D		
		8		193159	GRLZ-1/8-QS-8-D		

Ordering data – Screws					
	For ø	For accessories	Part no.	Type	PU <sup>1)</sup>
	80	HNC, FNC, SNC, SNCB, SNCS, SNCL	238600	DIN 912-M10X30-8.8	1
		ZNCF	204138	DIN 912-M10X40-10.9	
	100	HNC, FNC, SNC, SNCB, SNCS, SNCL	238600	DIN 912-M10X30-8.8	
		ZNCF	370524	DIN 912-M10X50-8.8	

1) Packaging unit