

# Linear gantries

**FESTO**

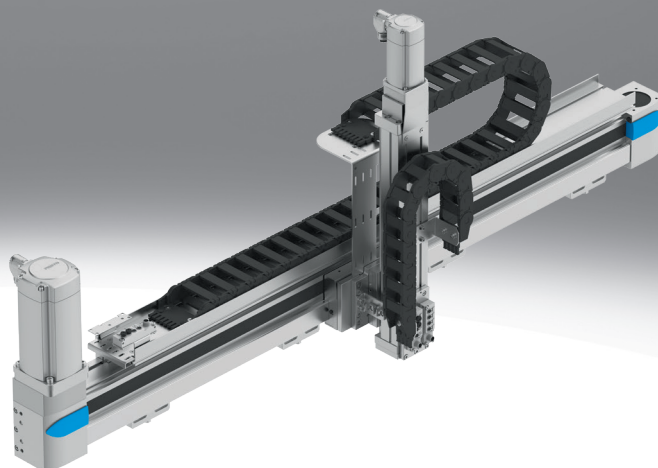

## Key features

### At a glance

A linear gantry (YXCL) is an assembly of several axis modules (EHM.../DHMZ) to produce a movement in 2D space. The linear gantry facilitates movement in 2D space. Depending on the requirements, the gantry is either composed of several axis modules (YXCL) or using the linear gantry EXCT (YXML). These are all tried-and-tested components from Festo.

- Very demanding requirements for precision and/or very heavy workpieces combined with long strokes (YXCR)
- Cost-effective handling unit in a compact format for small parts handling and simple tasks (YXCR-B)
- Frequently used in feeding or loading applications
- Use of tried-and-tested drives/axes from Festo

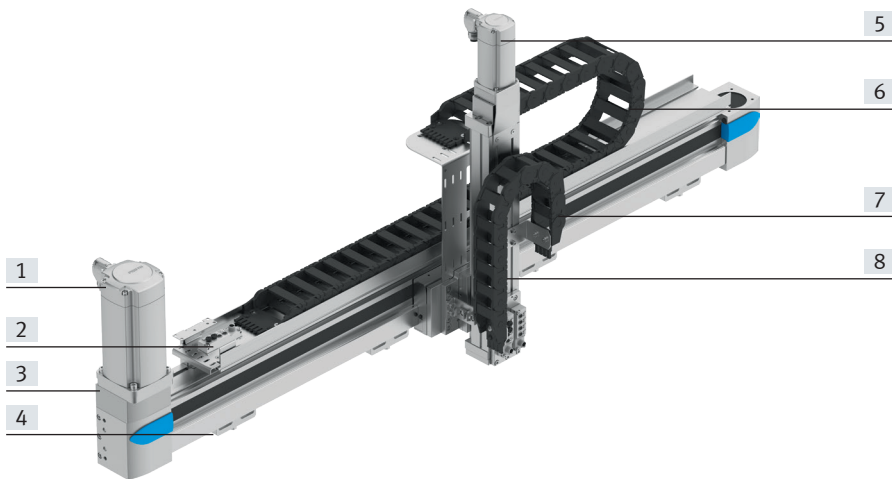

- [1] Servo motor for the Y-module
- [2] Multi-pin plug distributor which transfers all the electrical signals such as for end-position sensing
- [3] Y-axis
- [4] Profile mounting/adjusting kit
- [5] Servo motor for the Z-module
- [6] Energy chain for the Y-module
- [7] Energy chain for the Z-module
- [8] Z-axis

### Description of the modules

#### Y-module

##### Design:

The Y-module EHYM comprises a linear axis which is powered by a servo or stepper motor.

Adapters are mounted on the slides of the Y-axis to connect the Z-module.

The following components are located on the motor side:

- Energy chain (optional)
- Multi-pin plug distributor for proximity switch (if a sensor package has been selected)

##### Sample image:

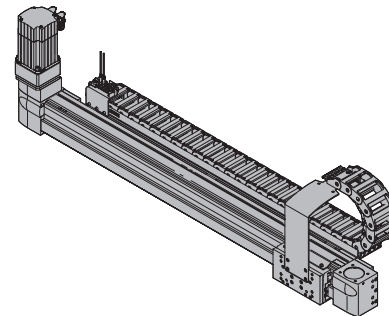

#### Z-module

##### Design:

The Z-module EHMZ comprises an electric drive, the DHMZ comprises a pneumatic drive. Based on the configuration, an energy chain is optionally installed as a cable guide depending on the axis type and stroke.

The Z-module can be selected using the configurator, depending on the application.

##### Sample image:

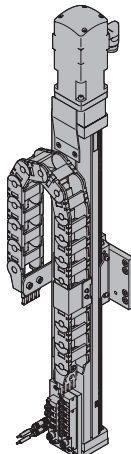

## Key features

### Description of the modules

#### YZ-module (EXCT)

#### Design:

Two fixed servo motors drive a toothed belt arranged in a T-shape. The toothed belt moves the slide of the Y-axis and the interface located on the Z-axis in a two-dimensional space. A controller calculates the position of the interface. The controlled interaction of the motors results in the movement of the interface. Other components can be attached so that additional processes to be carried out.

#### Sample image:

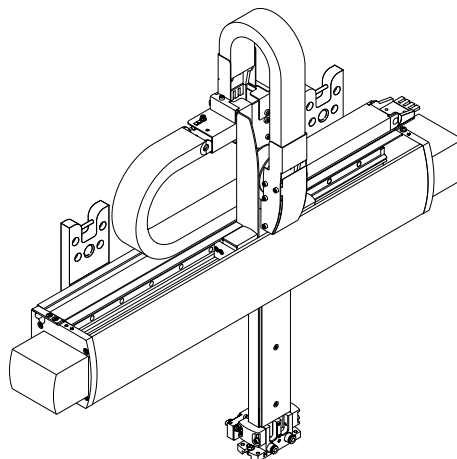

### Dispatch options

#### Fully assembled:

The linear gantry is fully assembled. All cables and tubing are installed and connected.

#### Partially assembled:

The linear gantry is delivered partially assembled. This means that both axis modules (Y-/Z-axis) are assembled, each with the optional motors. The partially assembled system must be completed by the customer. Help can be found in the assembly instructions provided. Optional accessories (→ page 10) are enclosed. Note flatness → table below.

#### System overview<sup>1)</sup>

Size	YXCL-1	YXCL-2	YXCL-3	YXCL-4	YXML-1	YXML-2	YXML-3
Max. working stroke	Y: 1900 mm Z: 50 mm	Y: 3000 mm Z: 1000 mm	Y: 3000 mm Z: 1200 mm	Y: 3000 mm Z: 1200 mm	Y: 1000 mm Z: 200 mm	Y: 1500 mm Z: 500 mm	Y: 2000 mm Z: 800 mm
Max. payload	Dependent on the selected dynamic response						
Mounting position	Horizontal						

Size	YXCL-1-B	YXCL-2-B
Max. working stroke	Y: 800 mm Z: 150 mm	Y: 1200 mm Z: 200 mm
Max. payload	Dependent on the selected dynamic response	
Mounting position	Horizontal	

1) Drive package depends on the configuration selected.

## Key features

### Configurator: Handling Guide Online (HGO)

Selecting a handling system

Planning complex handling systems takes a lot of time. You can use the configurator "Handling Guide Online" (HGO) to design a customised handling system for your application in just a few steps.

You can choose from the following systems:





- Single-axis system
- 2D linear gantry
- 2D planar surface gantry
- Three-dimensional gantry
- 3D cantilever system

#### Advantages:

- Automatic selection of all relevant components
- Automatic design and calculation of the workload
- Quote created automatically
- CAD model available immediately
- Configuration-specific parameters for servo drives available immediately
- Complete Eplan project can be ordered according to the individual configuration
- Fully automated processing
- You can order fully or partially assembled systems through the On-line Shop
- Lots of possible options

### Selecting the handling solution

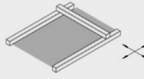
Select your handling system

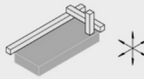
<input type="radio"/> Single-axis system		<p>Single-axis movement: Single-axis module as a complete system. Easy to connect to your own front unit.</p> <p><input type="checkbox"/> Animation</p>
<input type="radio"/> 2D linear gantry		<p>Movements in 2D in the vertical working space: Linear gantries as complete systems. Electric and pneumatic axes can be combined</p> <p><input type="checkbox"/> Animation</p>
<input type="radio"/> 2D gantry		<p>Movements in 2D in the horizontal working space: Planar surface gantries as complete systems. Combining electric axes. Easy to connect to your own Z unit.</p> <p><input type="checkbox"/> Animation</p>
<input type="radio"/> 3D gantry		<p>Movements in 3D: Three-dimensional gantries as complete systems. Electric and pneumatic axes can be combined</p> <p><input type="checkbox"/> Animation</p>
<input type="radio"/> 3D cantilever system		<p>Movements in 3D: Cantilever system as complete system. Electric and pneumatic axes can be combined</p>

### Entering the application data

- Payload
- Drive system of the axis
- Distance from the centre of the load
- Working stroke
- Reference cycle

### Axis definition and payload

Axis definition

Drive system of the axis

Y Electric: several positions

Z Electric: several positions

Required working stroke

i Y  mm

Working stroke in Z direction

i Z  mm

Take the stroke reserve into account in your specification



Payload

Sum of the weight of the front unit and the workpiece

kg

Distance from the centre of the load

i X  mm

i Y  mm

i Z  mm

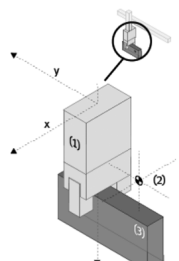

Data protection

## Key features

### Configurator: Handling Guide Online (HGO)

#### Result of the calculation

You will be offered a selection of systems that have been calculated based on the application data you entered.

The following are available immediately:

- CAD model
- Datasheet of the selected system
- Price information

#### Result of calculation

Select the appropriate system and continue with the configuration:

Selection Filter

No.	System series	System workload i	Repetition accuracy (+/-)	Your price
<input checked="" type="checkbox"/>	1 YXML-1	11 %	0.1 mm	
<input type="checkbox"/>	5 YXCL-1	44 %	0.08 mm	
<input type="checkbox"/>	7 YXCL-3	95 %	0.08 mm	
<input type="checkbox"/>	9 YXCL-2	34 %	0.08 mm	
<input type="checkbox"/>	11 YXCL-2	25 %	0.08 mm	

Requires additional motion controller for interpolation ( e.g. CPX-E-CEC-M1- ... )

#### 2D linear gantry YXML-1: #1

Drive module	YZ module: Linear gantry EXCT-15
Kinematics type	Parallel kinematics
Stroke	200 mm/100 mm
Repetition accuracy (+/-)	-
Gear unit	Without
Type of motor	Servo motor EMMS-AS
Motor position	Rear/Rear
Motor controller	EMMS-AS-M1
Data protection	

Back

Continue

#### System overview

You will be given an overview of the complete system.

- Show price
- Send request

You will also have the following options:

- Add to basket

#### Your handling solution

Your selected system overview:

Exemplary representation

©2022 powered by CADENAS

Update CAD Preview

Your system ID:  
**C2534095**

Your next step:

[Show price](#)

[Send request](#)

[Add to Cart](#)

## Key features

### Standard components within the handling system

The handling system comprises a number of tried-and-tested standard components from Festo. Different components are used depending on the configuration. The single axes installed will be displayed in the configurator HGO on the "Result of the calculation" page.

#### Y-axis

##### Toothed belt axis EGC-TB-KF



- Electrical
- Rigid, closed profile
- Recirculating ball bearing guide for high loads and torques
- High dynamic response and minimum vibration

##### Toothed belt axis ELGC-TB



- Electrical
- Optimal installation space to working space ratio
- Protected against external influences by internal guide
- High dynamic response

##### Ball screw axis ELGC-BS



- Electrical
- Optimal installation space to working space ratio
- Protected against external influences by internal guide
- Various spindle pitches

##### Toothed belt axis EGC-HD-TB

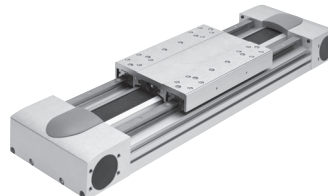

- Electrical
- Flat drive unit with rigid, closed profile
- Duo guide rail
- For maximum loads and torques, high feed forces and speeds and long service life

#### Z-axis

##### Mini slide EGSC



- Electrical
- Compact design
- High load capacity
- Precision guide and ball screw
- Easy adjustment of end positions

##### Mini slide EGSL

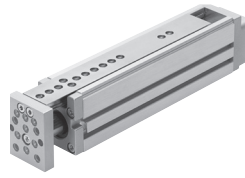

- Electrical
- Compact design
- High load capacity
- High dynamic response
- Easy adjustment of end positions

##### Mini slide DGST



- Pneumatic system
- Precise and resilient roller bearing guide
- Slide and yoke plate as a single component
- High dynamic response

##### Mini slide DGSL



- Pneumatic system
- Flat design
- High load capacity
- High dynamic response
- Easy adjustment of end positions

##### Ball screw axis EGC-BS-KF



- Electrical
- Rigid, closed profile
- Recirculating ball bearing guide for high loads and torques
- High dynamic response and minimum vibration
- Various spindle pitches

##### Cantilever axis ELCC

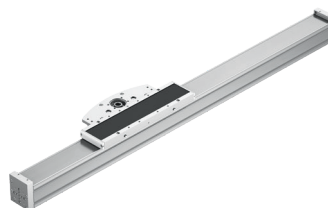

- Stationary drive head
- Toothed belt drive with recirculating ball bearing guide
- High rigidity thanks to the innovative design principle
- Very low moving mass

## Key features

Possible axis combinations <sup>1)</sup>		
Size	Y-module	Z-module
YXCL-1	<ul style="list-style-type: none"> <li>Toothed belt axis EGC-50-TB-KF</li> </ul>	<ul style="list-style-type: none"> <li>Mini slide pneumatic: DGSL-6 electric: EGSL-35</li> </ul>
YXCL-1-B	<ul style="list-style-type: none"> <li>Toothed belt axis ELGC-60-TB</li> <li>Ball screw axis ELGC-60-BS</li> </ul>	<ul style="list-style-type: none"> <li>Mini slide pneumatic: DGST-12/16 electric: EGSC-45</li> </ul>
YXCL-2	<ul style="list-style-type: none"> <li>Toothed belt axis EGC-80-TB-KF</li> <li>Toothed belt axis with heavy-duty guide EGC-HD-125-TB</li> </ul>	<ul style="list-style-type: none"> <li>Mini slide pneumatic: DGSL-12/16 electric: EGSL-45/55</li> <li>Cantilever axis ELCC-60</li> <li>Ball screw axis EGC-70-BS-KF</li> </ul>
YXCL-2-B	<ul style="list-style-type: none"> <li>Toothed belt axis ELGC-80-TB</li> <li>Ball screw axis ELGC-80-BS</li> </ul>	<ul style="list-style-type: none"> <li>Mini slide pneumatic: DGST-16/20 electric: EGSC-60</li> </ul>
YXCL-3	<ul style="list-style-type: none"> <li>Toothed belt axis EGC-120-TB-KF</li> <li>Toothed belt axis with heavy-duty guide EGC-HD-160-TB</li> </ul>	<ul style="list-style-type: none"> <li>Mini slide pneumatic: DGSL-20/25 electric: EGSL-75</li> <li>Cantilever axis ELCC-70</li> <li>Ball screw axis EGC-80-BS-KF</li> </ul>
YXCL-4	<ul style="list-style-type: none"> <li>Toothed belt axis EGC-185-TB-KF</li> <li>Toothed belt axis with heavy-duty guide EGC-HD-220-TB</li> </ul>	<ul style="list-style-type: none"> <li>Cantilever axis ELCC-90</li> <li>Ball screw axis EGC-120-BS-KF</li> </ul>
YXML-1	<ul style="list-style-type: none"> <li>Linear gantry EXCT-15</li> </ul>	<ul style="list-style-type: none"> <li>Linear gantry EXCT-15</li> </ul>
YXML-2	<ul style="list-style-type: none"> <li>Linear gantry EXCT-30</li> </ul>	<ul style="list-style-type: none"> <li>Linear gantry EXCT-30</li> </ul>
YXML-3	<ul style="list-style-type: none"> <li>Linear gantry EXCT-100</li> </ul>	<ul style="list-style-type: none"> <li>Linear gantry EXCT-100</li> </ul>

1) Drive package depends on the configuration selected.

## Key features

### Standard components within the handling system

The handling system comprises a number of tried-and-tested standard components from Festo. Different components are used depending on the configuration. You can alter the scope and design of the drive package in the configurator HGO on the "System configuration" page.

### Motors and controllers

#### Servo motors EMMT-AS



- Dynamic, brushless, permanently excited servo motor
- Digital absolute displacement encoder in single-turn or multi-turn version
- Simple connection technology (OCP: one cable plug) – hybrid cable: motor cable and connecting cable for supply and encoder in one
- Plug can be rotated 310°
- With optional brake

#### Servo motors EMMB-AS



- Dynamic, brushless, permanently excited servo motor
- Digital absolute displacement encoder in single-turn or multi-turn version
- Optimised connection technology
- With optional brake

#### Stepper motors EMMT-ST

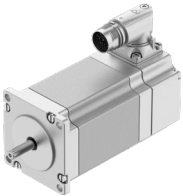

- Two-phase hybrid technology
- Digital absolute displacement encoder in single-turn or multi-turn version
- Simple connection technology (OCP: one cable plug) – hybrid cable: motor cable and connecting cable for supply and encoder in one
- Plug can be rotated 310°
- With optional brake

#### Stepper motors EMMB-ST

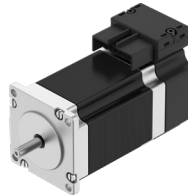

- Two-phase hybrid technology
- Digital absolute displacement encoder in single-turn or multi-turn version
- Simple connection technology (OCP: one cable plug) – hybrid cable: motor cable and connecting cable for supply and encoder in one
- Can be positioned to the front or the rear
- With optional brake

#### Gear unit EMGA



- Low-backlash planetary gear
- Gear ratio  
 $i = 3$  and  $5$
- Life-time lubrication



## Key features

### Standard components within the handling system

The handling system comprises a number of tried-and-tested standard components from Festo. Different components are used depending on the configuration. You can alter the scope and design of the drive package in the configurator HGO on the "System configuration" page.

#### Servo drive CMMT-AS, for servo motor



- Universal servo drive
- For synchronous servo motors
- Integrated EMC filters
- Integrated brake chopper
- Integrated braking resistor
- Position controller
- Speed controller
- Force controller
- Range of control functions

#### Options:

- Safety function: safe torque off (STO)/category 4, Performance Level e
- Safe stop 1 (SS1)
- Safe brake control (SBC) up to SIL3/category 3, Performance Level e

- Bus protocols
  - EtherCAT®
  - PROFINET RT/IRT
  - EtherNet/IP
  - Modbus TCP

#### Servo drive CMMT-ST, for stepper motor



- Servo drive for operating stepper motors and brushless direct current motors
- Options for point-to-point and interpolating motion and for precise positioning
- Primary voltage from 24 ... 48 V DC
- Position controller
- Speed controller
- Force controller
- Range of control functions

#### Options:

- Safety function: safe torque off (STO)/category 3, Performance Level e
- Safe stop 1 time controlled (SS1-t)

- Bus protocols
  - EtherCAT®
  - PROFINET RT/IRT
  - EtherNet/IP
  - Modbus TCP

## Ordering data – Accessories

### Module/motor combinations

We recommend that the linear gantry is operated with the proposed motors from Festo. These precisely match the mechanical system. When using third-party motors, it is essential that the technical limits are observed.

Module	Motor		Stepper motor	
	Servo motor			
<b>Y-module</b>				
EHMY-...-EGC-50-TB-KF	–	–	EMMT-ST-57-L-...	EMMB-ST-57-L-...
EHMY-...-EGC-80-TB-KF	EMMT-AS-60-S-LS-...	–	EMMT-ST-57-M-...	EMMB-ST-57-M-...
EHMY-...-EGC-120-TB-KF	EMMT-AS-80-L-LS-...	–	EMMT-ST-87-S-...	EMMB-ST-87-S-...
	EMMT-AS-80-L-HS-...	–	–	–
EHMY-...-EGC-125-TB-HD	EMMT-AS-60-L-LS-...	–	EMMT-ST-57-M-...	EMMB-ST-57-M-...
EHMY-...-EGC-160-TB-HD	EMMT-AS-80-M-LS-...	–	EMMT-ST-87-S-...	EMMB-ST-87-S-...
	EMMT-AS-80-L-HS-...	–	–	–
EHMY-...-EGC-185-TB-KF	EMMT-AS-100-L-HS-...	–	–	–
	EMMT-AS-100-H-HS-...	–	–	–
	EMMT-AS-150-M-HV-R3...	–	–	–
EHMY-...-EGC-220-TB-HD	EMMT-AS-100-L-HS-...	–	–	–
	EMMT-AS-100-H-HS-...	–	–	–
	EMMT-AS-150-M-HV-R3...	–	–	–
EHMY-LP-ELGC-60-BS	–	EMMB-AS-60-04	EMMT-ST-57-L-...	EMMB-ST-57-L-...
EHMY-LP-ELGC-80-BS	–	EMMB-AS-60-04	EMMT-ST-87-M-...	EMMB-ST-87-M-...
EHMY-LP-ELGC-60-TB	–	EMMB-AS-80-07	EMMT-ST-87-M-...	EMMB-ST-87-M-...
EHMY-LP-ELGC-80-TB	–	EMMB-AS-80-07	EMMT-ST-87-L-...	EMMB-ST-87-M-...
<b>Z-module</b>				
EHMZ-ELCC-60-TB-KF	EMMT-AS-60-M-LS-...	–	–	–
	EMMT-AS-80-L-LS-...	–	–	–
	EMMT-AS-100-S-HS-...	–	–	–
EHMZ-ELCC-70-TB-KF	EMMT-AS-80-M-LS-...	–	–	–
	EMMT-AS-80-L-HS-...	–	–	–
EHMZ-ELCC-90-TB-KF	EMMT-AS-80-L-HS-...	–	–	–
	EMMT-AS-100-L-HS-...	–	–	–
	EMMT-AS-100-H-HS-...	–	–	–
EHMZ-EGC-70-BS-KF	EMMT-AS-60-S-LS-...	–	EMMT-ST-57-M-...	EMMB-ST-57-M-...
EHMZ-EGC-80-BS-KF	EMMT-AS-60-M-LS-...	–	EMMT-ST-57-M-...	EMMB-ST-57-M-...
EHMZ-EGC-120-BS-KF	EMMT-AS-80-S-LS-...	–	–	–
	EMMT-AS-80-M-LS-...	–	–	–
	EMMT-AS-80-S-HS-...	–	–	–
	EMMT-AS-80-L-HS-...	–	–	–
EHMZ-EGSL-35-BS-KF	–	–	EMMT-ST-42-S-...	EMMB-ST-42-S-...
EHMZ-EGSL-45-BS-KF	EMMT-AS-60-S-LS-...	–	EMMT-ST-57-M-...	EMMB-ST-57-M-...
EHMZ-EGSL-55-BS-KF	EMMT-AS-60-S-LS-...	–	EMMT-ST-57-M-...	EMMB-ST-57-M-...
EHMZ-EGSL-75-BS-KF	EMMT-AS-80-S-LS-...	–	EMMT-ST-87-S-...	EMMB-ST-87-S-...
EHMZ-EGSC-45	–	EMMB-AS-40-01	EMMT-ST-42-L-...	EMMB-ST-42-L-...
EHMZ-EGSC-60	–	EMMB-AS-60-02	EMMT-ST-57-L-...	EMMB-ST-57-L-...
<b>YZ-module (EXCT)</b>				
EXCT-15	EMMT-AS-80-M-LS-...	–	–	–
EXCT-30	EMMT-AS-100-M-HS-...	–	–	–
EXCT-100	EMMT-AS-100-M-HS-...	–	–	–
	EMMT-AS-100-H-HS-...	–	–	–

## Ordering data – Accessories

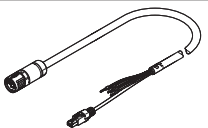
Ordering data	Description	Cable length [m]	Part no.	Type
<b>For servo motor EMMT-AS</b>				
<b>Motor cable</b>				
	• For EMMT-AS-60/80-...-R2... with CMMT-AS	2.5	5251374	NEBM-M23G15-EH-2.5-Q7N-R3LEG14
		5	5251375	NEBM-M23G15-EH-5-Q7N-R3LEG14
		7.5	5251376	NEBM-M23G15-EH-7.5-Q7N-R3LEG14
		10	5251377	NEBM-M23G15-EH-10-Q7N-R3LEG14
		15	5251378	NEBM-M23G15-EH-15-Q7N-R3LEG14
		20	5251379	NEBM-M23G15-EH-20-Q7N-R3LEG14
	• For EMMT-AS-100-...-R2... with CMMT-AS	2.5	5251381	NEBM-M23G15-EH-2.5-Q9N-R3LEG14
		5	5251382	NEBM-M23G15-EH-5-Q9N-R3LEG14
		7.5	5251383	NEBM-M23G15-EH-7.5-Q9N-R3LEG14
		10	5251384	NEBM-M23G15-EH-10-Q9N-R3LEG14
		15	5251385	NEBM-M23G15-EH-15-Q9N-R3LEG14
		20	5251386	NEBM-M23G15-EH-20-Q9N-R3LEG14
	• For EMMT-AS-150-...-R3... with CMMT-AS	2.5	5251395	NEBM-M40G15-EH-2.5-Q11N-R3LEG14
		5	5251396	NEBM-M40G15-EH-5-Q11N-R3LEG14
		7.5	5251397	NEBM-M40G15-EH-7.5-Q11N-R3LEG14
10		5251398	NEBM-M40G15-EH-10-Q11N-R3LEG14	
15		5251399	NEBM-M40G15-EH-15-Q11N-R3LEG14	
20		5251400	NEBM-M40G15-EH-20-Q11N-R3LEG14	

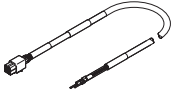
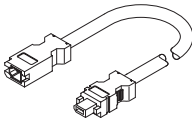
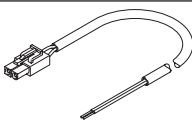
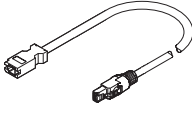
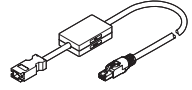
Ordering data	Description	Cable length [m]	Part no.	Type
<b>For servo motor EMMB-AS</b>				
<b>Motor cable</b>				
	• For EMMB-AS-40/60/80 with CMMT-AS	2.5	5219197	NEBM-H6G4-E-2.5-Q13N-LE4
		5	5219198	NEBM-H6G4-E-5-Q13N-LE4
		7.5	5219199	NEBM-H6G4-E-7.5-Q13N-LE4
		10	5219200	NEBM-H6G4-E-10-Q13N-LE4
		15	8097203	NEBM-H6G4-E-15-Q13N-LE4
<b>Encoder cable</b>				
	• For EMMB-AS-40/60/80 with CMMT-AS	2.5	5219213	NEBM-REG6-E-2.5-Q14N-REG6
		5	5219214	NEBM-REG6-E-5-Q14N-REG6
		7.5	5219215	NEBM-REG6-E-7.5-Q14N-REG6
		10	5219216	NEBM-REG6-E-10-Q14N-REG6
		15	8097200	NEBM-REG6-E-15-Q14N-REG6
<b>Connecting cable for brake</b>				
	• For EMMB-AS-40/60/80 with CMMT-AS	2.5	5219205	NEBM-H7G2-E-2.5-Q14N-LE2
		5	5219206	NEBM-H7G2-E-5-Q14N-LE2
		7.5	5219207	NEBM-H7G2-E-7.5-Q14N-LE2
		10	5219208	NEBM-H7G2-E-10-Q14N-LE2
		15	8097206	NEBM-H7G2-E-15-Q14N-LE2
<b>Adapter for encoder cable (absolutely essential)</b>				
	• For EMMB-AS-40/60/80 with CMMT-AS	<b>For single-turn version with CMMT-AS</b>		
		0.5	8097197	NEFM-REG6-K-0.5-R3G8
	• For EMMB-AS-40/60/80 with CMMT-AS <sup>1)</sup>	<b>For multi-turn version with CMMT-AS<sup>1)</sup></b>		
		0.5	8097195	NEFM-REG6-K-0.5-B-R3G8
		<b>For multi-turn version with CMMB-AS<sup>1)</sup></b>		
		0.5	8097196	NEFM-REG6-K-0.5-B-REG6

1) The required battery is not included in the scope of delivery

## Ordering data – Accessories

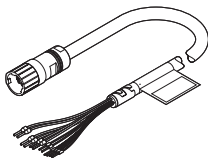
Designation	Description	Cable length [m]	Part no.	Type
<b>For stepper motor EMMT-ST</b>				
<b>Motor cable</b>				
	• For EMMT-ST-42-... with CMMT-ST	2.5	8181670	NEBM-M17G12-EH-2.5-Q6N-LE12
		5	8181668	NEBM-M17G12-EH-5-Q6N-LE12
		7	8190096	NEBM-M17G12-EH-7.5-Q6N-LE12
		10	8195457	NEBM-M17G12-EH-10-Q6N-LE12
		15	8214679	NEBM-M17G12-EH-15-Q6N-LE12
	• For EMMT-ST-57-... with CMMT-ST	2.5	8181670	NEBM-M17G12-EH-2.5-Q6N-LE12
		5	8181668	NEBM-M17G12-EH-5-Q6N-LE12
		7	8195460	NEBM-M17G12-EH-7.5-Q7N-LE12
		10	8195461	NEBM-M17G12-EH-10-Q7N-LE12
		15	8214683	NEBM-M17G12-EH-15-Q9N-LE12
	• For EMMT-ST-87-... with CMMT-ST	2.5	8195458	NEBM-M17G12-EH-2.5-Q7N-LE12
		5	8195459	NEBM-M17G12-EH-5-Q7N-LE12
		7	8214681	NEBM-M17G12-EH-7.5-Q9N-LE12
		10	8214682	NEBM-M17G12-EH-10-Q9N-LE12
		15	8214683	NEBM-M17G12-EH-15-Q9N-LE12

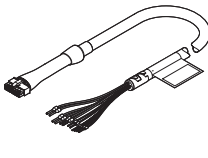
Designation	Description	Cable length [m]	Part no.	Type
<b>For stepper motor EMMB-ST</b>				
<b>Motor cable</b>				
	• For EMMB-ST-42-... with CMMT-ST	2.5	8181675	NEBM-L5G14-EH-2.5-Q6N-LE12
		5	8181664	NEBM-L5G14-EH-5-Q6N-LE12
		7	8181676	NEBM-L5G14-EH-7.5-Q6N-LE12
		10	8181672	NEBM-L5G14-EH-10-Q6N-LE12
		15	8214680	NEBM-L5G14-EH-15-Q6N-LE12
	• For EMMB-ST-57-... with CMMT-ST	2.5	8181677	NEBM-L10G14-EH-2.5-Q6N-LE12
		5	8181667	NEBM-L10G14-EH-5-Q6N-LE12
		7	8181674	NEBM-L10G14-EH-7.5-Q7N-LE12
		10	8181673	NEBM-L10G14-EH-10-Q7N-LE12
		15	8214689	NEBM-L10G14-EH-15-Q9N-LE12
	• For EMMB-ST-87-... with CMMT-ST	2.5	8181666	NEBM-L10G14-EH-2.5-Q7N-LE12
		5	8181671	NEBM-L10G14-EH-5-Q7N-LE12
		7	8214687	NEBM-L10G14-EH-7.5-Q9N-LE12
		10	8214688	NEBM-L10G14-EH-10-Q9N-LE12
		15	8214689	NEBM-L10G14-EH-15-Q9N-LE12

### Possible cable and tube lengths

- Cables and tubing are selected so that the length specified when ordering will be the minimum connection length from the energy chain output.
- Cables and tubing are only available in fixed lengths as stated in the table below. This can mean that the cable plugs of the different cables do not end at the same point.

Length	1 m	2 m	5 m	7 m	10 m
Motor cable	–	■	■	■	■
Encoder cable	–	■	■	■	■
Multi-pin plug connecting cable	–	■	■	■	■
Tubing (for DHMZ only)	■	■	■	–	–

## Ordering data – Accessories

### Standard components within the handling system



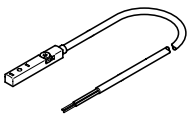
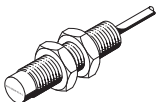
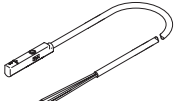
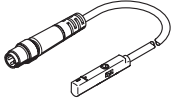
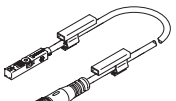
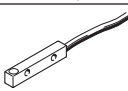

The handling system comprises a number of tried-and-tested standard components from Festo. Different components are used depending on the configuration. You can alter the scope and design of the accessories in the configurator HGO on the "System configuration" page.

Designation	Description	Cable length [m]	Part no.	Type	
<b>Proximity switch (inductive) for sensing the position of the slide on the Y-/Z-axis</b>					
	<b>Cable with open end</b>				
	<ul style="list-style-type: none"> <li>For toothed belt axis EGC-TB, EGC-HD-TB</li> <li>For toothed belt axis ELGC-TB</li> <li>For ball screw axis ELGC-BS</li> <li>For ball screw axis EGC-BS</li> <li>For mini slide EGSL</li> <li>For mini slide EGSC</li> <li>For DC voltage</li> </ul> Included if the "Festo sensor package" is selected: <ul style="list-style-type: none"> <li>For EGC: 2 pieces</li> <li>For EGSL, EGSC: 1 piece</li> </ul>	PNP, N/C contact	7.5	551391	SIES-8M-PO-24V-K-7.5-OE
		PNP, N/O contact	7.5	551386	SIES-8M-PS-24V-K-7.5-OE
		NPN, N/C contact	7.5	551401	SIES-8M-NO-24V-K-7.5-OE
		NPN, N/O contact	7.5	551396	SIES-8M-NS-24V-K-7.5-OE
<b>Proximity switch (inductive) for sensing the position of the slide on the Z-axis</b>					
	<b>Cable with open end</b>				
	<ul style="list-style-type: none"> <li>For cantilever axis ELCC</li> <li>For DC voltage</li> </ul> Included if the "Festo sensor package" is selected: <ul style="list-style-type: none"> <li>2 pieces</li> </ul>	PNP, N/C contact	2.5	150398	SIEN-M8NB-PO-K-L
		PNP, N/O contact	2.5	150394	SIEN-M8NB-PS-K-L
		NPN, N/C contact	2.5	150396	SIEN-M8NB-NO-K-L
NPN, N/O contact		2.5	150392	SIEN-M8NB-NS-K-L	
<b>Proximity switches (magneto-resistive) for sensing the position of the slide on the Z-axis</b>					
	<b>Cable with open end</b>				
	<ul style="list-style-type: none"> <li>For mini slide DGSL</li> <li>For DC voltage</li> </ul> Included if the "Festo sensor package" is selected: <ul style="list-style-type: none"> <li>2 pieces</li> </ul>	PNP, N/O contact	2.5	551373	SMT-10M-PS-24V-E-2.5-L-OE
NPN, N/O contact		2.5	551377	SMT-10M-NS-24V-E-2.5-L-OE	
<b>Proximity switches (magneto-resistive) for sensing the position of the slide on the Z-axis</b>					
	<ul style="list-style-type: none"> <li>For mini slide DGST-8/-12</li> <li>For DC voltage</li> </ul> Included if the "Festo sensor package" is selected: <ul style="list-style-type: none"> <li>2 pieces</li> </ul>	PNP, N/O contact	2.5	551375	SMT-10M-PS-24V-E-0.3-L-M8D
		NPN, N/O contact	2.5	551379	SMT-10M-NS-24V-E-0.3-L-M8D
	<ul style="list-style-type: none"> <li>For mini slide DGST-16/-20</li> <li>For DC voltage</li> </ul> Included if the "Festo sensor package" is selected: <ul style="list-style-type: none"> <li>2 pieces</li> </ul>	PNP, N/O contact	2.5	574334	SMT-8M-A-PS-24V-E-0.3-M8D
		NPN, N/O contact	2.5	574339	SMT-8M-A-NS-24V-E-0.3-M8D
<b>Proximity switch for sensing the position of the slide on the Y-/Z-axis</b>					
	<ul style="list-style-type: none"> <li>For EXCT</li> <li>For DC voltage</li> <li>For sensing kit EAPR-E17</li> </ul>	PNP, N/C contact	2.5	174552	SIES-Q8B-PO-K-L
		PNP, N/O contact	2.5	178294	SIES-Q8B-PS-K-L
		NPN, N/C contact	2.5	174550	SIES-Q8B-NO-K-L
		PNP, N/O contact	2.5	178292	SIES-Q8B-NS-K-L

## Ordering data – Accessories

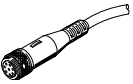
### Standard components within the handling system

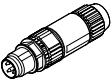
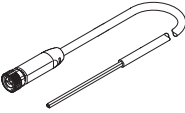
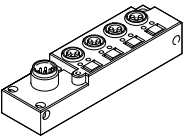
The handling system comprises a number of tried-and-tested standard components from Festo. Different components are used depending on the configuration. You can alter the scope and design of the accessories in the configurator HGO on the "System configuration" page.

Designation	Description	Cable length [m]	Part no.	Type
<b>Plug socket with cable</b>				
	<ul style="list-style-type: none"> <li>• Connection between multi-pin plug distributor NEDU and control cabinet</li> </ul>	5	<b>525618</b>	<b>SIM-M12-8GD-5-PU</b>
		10	<b>570008</b>	<b>SIM-M12-8GD-10-PU</b>
<b>Plug socket with cable</b>				
	<ul style="list-style-type: none"> <li>• For EXCT</li> <li>• For multi-pin SET EADH</li> </ul>	15	<b>8048086</b>	<b>NEBU-M12W8-K-15-N-LE8</b>
<b>Plug</b>				
	<ul style="list-style-type: none"> <li>• For connection to the multi-pin plug distributor NEDU / distributor NEDY</li> </ul>	–	<b>562024</b>	<b>NECU-S-M8G3-HX</b>
<b>Connecting cable</b>				
	<ul style="list-style-type: none"> <li>• Connection between distributor NEDY and control cabinet</li> </ul>	2.5	<b>8078227</b>	<b>NEBA-M8G4-U-2.5-N-LE4</b>
		5	<b>8078228</b>	<b>NEBA-M8G4-U-5-N-LE4</b>
		7.5	<b>8215486</b>	<b>NEBA-M8G4-U-7.5-N-LE4</b>
		10	<b>8078229</b>	<b>NEBA-M8G4-U-10-N-LE4</b>
		15	<b>8215487</b>	<b>NEBA-M8G4-U-15-N-LE4</b>
<b>Multi-pin plug distributor</b>				
	<ul style="list-style-type: none"> <li>• With the help of the multi-pin plug distributor, all electrical signals such as for end-position sensing can be transferred</li> </ul> Options: <ul style="list-style-type: none"> <li>– 4 individual connections</li> <li>– 6 individual connections</li> </ul>	–	<b>574586</b>	<b>NEDU-L4R1-M8G3L-M12G8</b>
			<b>574587</b>	<b>NEDU-L6R1-M8G3L-M12G8</b>
	<ul style="list-style-type: none"> <li>• With the help of the distributor, all electrical signals such as for end-position sensing can be transferred</li> <li>– 2 individual connections</li> </ul>	–	<b>8005312</b>	<b>NEDY-L2R1-V1-M8G3-N-M8G4</b>

## Ordering data – Accessories

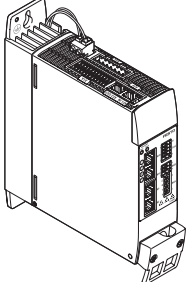
Designation	Description
<b>Motor controller/servo drive</b>	
	<p>The accessories for the relevant motor controllers/servo drives can be found at:</p> <ul style="list-style-type: none"> <li>• <a href="http://www.festo.com/catalogue/cmmt">www.festo.com/catalogue/cmmt</a></li> </ul>

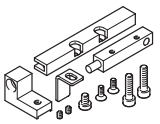
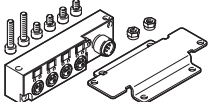
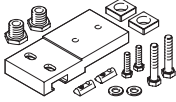
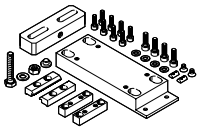
Designation	Description	Part no.	Type
<b>Sensing kit</b>			
	<ul style="list-style-type: none"> <li>• For EXCT</li> <li>• Included in the scope of delivery: proximity switch SIES-Q8B, sensor bracket, switch lug, mounting bracket and screws</li> </ul>	PNP, N/C contact	<b>8092368</b> <b>EAPR-E17-S1</b>
		PNP, N/O contact	<b>2478427</b> <b>EAPR-E17-S</b>
		NPN, N/C contact	<b>8092369</b> <b>EAPR-E17-S3</b>
		NPN, N/O contact	<b>8092370</b> <b>EAPR-E17-S4</b>
<b>Multi-pin set</b>			
	<ul style="list-style-type: none"> <li>• For EXCT</li> <li>• For connecting up to 4 inputs/outputs</li> </ul>	<b>2972137</b>	<b>EADH-E17-MP1</b>
<b>Mounting kit</b>			
	<ul style="list-style-type: none"> <li>• For EXCT</li> <li>• For mounting and aligning on a supporting surface</li> <li>• The kit is height-adjustable</li> </ul>	EXCT-15	<b>3838164</b> <b>EAHM-E17-K2-15</b>
		EXCT-30	<b>3838337</b> <b>EAHM-E17-K2-30</b>
		EXCT-100	<b>3838404</b> <b>EAHM-E17-K2-100</b>
<b>Adjusting kit</b>			
	<ul style="list-style-type: none"> <li>• Used to mount the handling system on a vertical surface</li> <li>• Once mounted, the axis can be aligned horizontally</li> </ul>	EHMY...-EGC-50-TB-KF	<b>8047576</b> <b>EADC-E16-50-E7</b>
		EHMY...-EGC-80-TB-KF	<b>8047577</b> <b>EADC-E16-80-E7</b>
		EHMY...-EGC-120-TB-KF	<b>8047578</b> <b>EADC-E16-120-E7</b>
		EHMY...-EGC-185-TB-KF	<b>8047579</b> <b>EADC-E16-185-E7</b>
		EHMY...-EGC-125-TB-HD	<b>8047580</b> <b>EADC-E16-125-E14</b>
		EHMY...-EGC-160-TB-HD	<b>8047581</b> <b>EADC-E16-160-E14</b>
		EHMY...-EGC-220-TB-HD	<b>8047582</b> <b>EADC-E16-220-E14</b>
		EHMY...-ELGC-60-BS	<b>8142654</b> <b>EADC-E16-60-E22</b>
EHMY...-ELGC-80-BS	<b>8142655</b> <b>EADC-E16-80-E22</b>		

## Programming support

### Festo Automation Suite

Parameterisation and programming software for electronic devices from Festo

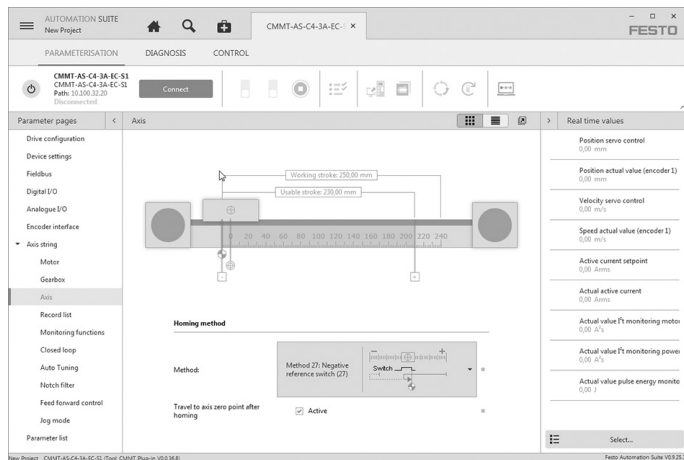

- Parameterisation, programming and commissioning in a clear and user-friendly interface
- Optimum support for complex processes thanks to guided wizards (e.g. for commissioning, drive configuration, etc.)
- Fast access to the required documents and additional information
- Easy integration of electric drives in the controller programming