

Position sensors SRBS

FESTO



Festo Core Range
Solves the majority of your automation tasks

With the Festo Core Range, we have selected the most important products and functions from our broad product catalogue, and added the quickest delivery.

Worldwide: Quickest delivery – wherever, whenever
Simply good: Expected high Festo quality
Fast: Easy and fast to select

The Core Range offers you the best value for your automation tasks.

Just look
for the
star!

Key features, product range overview

General information

The SRBS-Q1/Q12 is used to detect rotation of the shaft for rotary drives DRVS and DSM.

Sensing is magnetic and contactless. The sensor outputs two binary switching points.

- The sensor can be quickly mounted without having to manually search for switching points
- Simple and reliable operation using just one pushbutton directly on the device
- No need for a connecting cable as there are 2 switching points in a device
- Freely programmable PNP/NPN and NO/NC reduces warehousing
- Robust, contactless and encapsulated position detection with long service life

Switching output

DRVS-25- ... with SRBS-Q12-25- ...

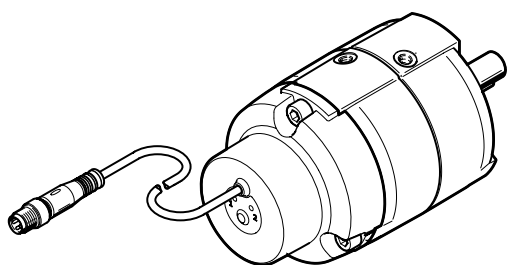

- 2 switching outputs 24 V
- Electronic teach-in of switching points at the push of a button
- Programmable PNP/NPN
- Programmable NO/NC
- Sensing range > 270°

Repetition accuracy ≤ 1°

Note
Sensors that detect magnetic fields, such as position sensors SRBS, must not be secured onto the drive using mountings made from ferritic materials, as this can lead to malfunction.

Product range overview

Design	Type	Suitable for rotary drives	Special characteristics	Sensing range [deg]	Switching output	→ Page/Internet
Position sensor	SRBS-Q12-6-E270-EP-1-S-M8	DSM 6, DRVS 6	Oil-resistant	> 270	2 x PNP or	4
	SRBS-Q12-8-E270-EP-1-S-M8	DSM 8, DRVS 8			2 x NPN	
	SRBS-Q1-10-E270-EP-1-S-M8	DSM 10			Switchable	
	SRBS-Q12-12-E270-EP-1-S-M8	DRVS 12				
	SRBS-Q12-16-E270-EP-1-S-M8	DRVS 16				
	SRBS-Q12-25-E270-EP-1-S-M8	DRVS 25				
	SRBS-Q12-32-E270-EP-1-S-M8	DRVS-32				
	SRBS-Q12-40-E270-EP-1-S-M8	DRVS 40				

Type codes

001	Series	
SRBS	Position sensor	

002	Allocation	
Q1	Version Q1	
Q12	Version Q12	

003	Size	
6	6	
8	8	
10	10	
12	12	
16	16	
25	25	
32	32	
40	40	

004	Display type	
E	LED	

005	Measuring range	
270	0 ... 270°	

006	Sensor principle	
EP	Contactless, programmable switching function	

007	Nominal operating voltage	
1	24 V DC	

008	Electrical output 1	
S	PNP or NPN	

009	Electrical connection	
M8	Plug M8	

Data sheet

Function

Normal operation

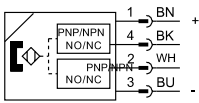

General technical data

Design	Round
Type of mounting	Screwed on
Mounting position	Any
Certification	RCM compliance mark c UL us Listed (OL)
KC mark	KC EMC
UKCA marking (see declaration of conformity)	To UK instructions for EMC To UK RoHS instructions
Special characteristics	Oil-resistant
Degree of protection	IP65 IP68
Protection class	III
Based on standard	EN 60947-5-2
Shock resistance	Shock test with severity level 2 to FN 942017-5 and EN 60068-2-27
Vibration resistance	Transport application check with severity level 3 to FN 942017-4 and EN 60068-2-6
CE marking (see declaration of conformity)	To EU EMC Directive
Note on materials	Halogen-free, RoHS-compliant
Corrosion resistance class CRC ¹⁾	2

1) Corrosion resistance class CRC 2 to Festo standard FN 940070

Moderate corrosion stress. Indoor applications in which condensation can occur. External visible parts with primarily decorative surface requirements which are in direct contact with a normal industrial environment.

Input signal/measuring element

Measuring principle	Magnetic Hall
Measured variable	Rotation angle
Sensing range [deg]	> 270
Ambient temperature [°C]	-20 ... 70
Ambient temperature with flexible cable installation [°C]	-20 ... 70
Storage temperature [°C]	-30 ... 70

Signal processing

Typical scanning interval [ms]	3
--------------------------------	---

Output, additional data

Short circuit protection	Yes
Overload protection	Present

Data sheet

Electronics		
Operating voltage range	[V DC]	10 ... 30
Rated operating voltage	[V DC]	24
Reverse polarity protection		For all electrical connections
Switching output		2 x PNP or 2 x NPN, switchable
Switching element function		N/C or N/O contact, switchable
Switching point repeatability	[°]	≤ 1
Residual ripple	[%]	10
Switch-on time	[ms]	< 4
Switch-off time	[ms]	< 4
Max. switching frequency	[Hz]	125
Max. output current	[mA]	50
No-load supply current	[mA]	≤ 20
Residual current	[mA]	< 0.05
Max. switching capacity DC	[W]	1.5
Voltage drop	[V]	< 1
Electromechanical components		
Electrical connection		
Connection type		Cable with plug
Connection technology		M8x1 A-coded according to EN 61076-2-104
Number of pins/wires		4
Type of mounting		Screw-type lock
Port pattern		
Outlet direction of connection		In-line
Cable characteristic		Cable chain + robot
Cable test conditions		Bending strength: to Festo standard
		Energy chain: 5 million cycles, bending radius 28 mm
		Torsional resistance: > 300,000 cycles, ±270°/0.1 m
Cable diameter	[mm]	2.9
Cable length	[m]	0.3
Display/operation		
Setting options		Pushbutton
Switching status indication		Yellow LED
Materials		
Housing		Reinforced PA
		Polyester
Housing colour		Black
Union nut		Nickel-plated brass
Cable sheath, grey		TPE-U(PUR)
Film		Polyester
Pin contacts		Gold-plated copper alloy

Data sheet

Dimensions

Download CAD data → www.festo.com

SRBS-Q12- ... -E270-EP-1-S-M8 (DRVS-6/8)

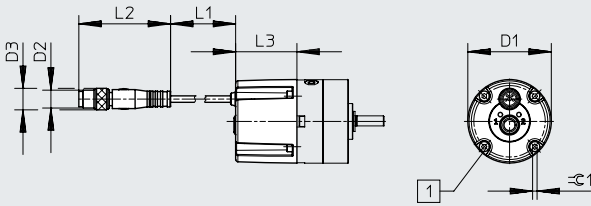

[1] Screw:
Size 6 – M2x6 (4x)
Size 8 – M2.5x5 (4x)



Type	D1 ∅	D2	D3 ∅	L1	L2	L3	±1
SRBS-Q12-6- ...	29.4	M8x1	9.6	300	41.1	25.4	1.5
SRBS-Q12-8- ...	32					27.4	2

Dimensions

Download CAD data → www.festo.com

SRBS-Q12- ... -E270-EP-1-S-M8 (DRVS-12/16/25)

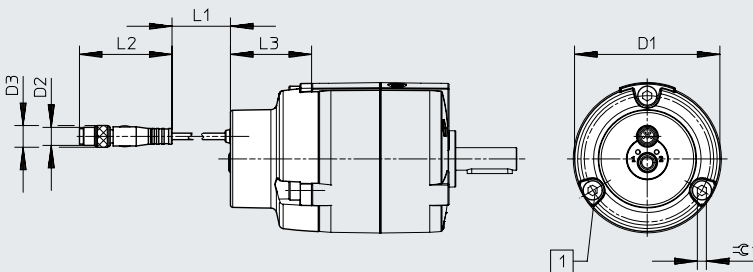

[1] Screw:
Size 12 – M4x10 (3x)
Size 16 – M5x12 (3x)
Size 25 – M5x12 (3x)



Type	D1 ∅	D2	D3 ∅	L1	L2	L3	±1
SRBS-Q12-12- ...	44.6	M8x1	9.6	300	41.1	29.4	3
SRBS-Q12-16- ...	51.6					33.9	4
SRBS-Q12-25- ...	64.5					36	4

Dimensions

Download CAD data → www.festo.com

SRBS-Q12- ... -E270-EP-1-S-M8 (DRVS-32/40)

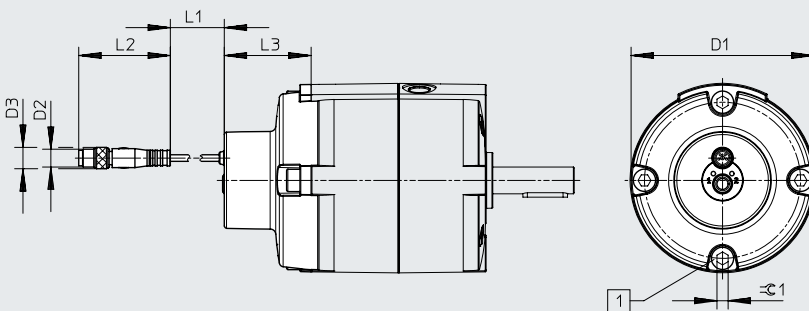

[1] Screw:
Size 32 – M6x12 (4x)
Size 40 – M8x16 (4x)



Type	D1 ∅	D2	D3 ∅	L1	L2	L3	±1
SRBS-Q12-32- ...	81.3	M8x1	9.6	300	41.1	38.9	5
SRBS-Q12-40- ...	98.3					40.4	6

Data sheet

Dimensions

Download CAD data → www.festo.com

SRBS-Q...-E270-EP-1-S-M8 (DSM-6/8/10)

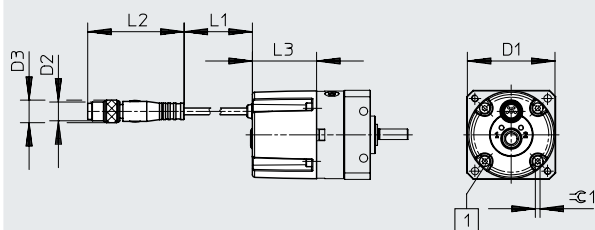

[1] Screw:

Size 6 – M2x6

Size 8 – M2.5x5

Size 10 – M3x6



Type	D1 ∅	D2	D3 ∅	L1	L2	L3	±1
SRBS-Q12-6- ...	29.4	M8x1	9.6	300	41.1	25.4	1.5
SRBS-Q12-8- ...	32					27.4	2
SRBS-Q1-10- ...	46.4					29.8	2.5

★ Core product range

Ordering data		Weight [g]	Part no.	Type
	For rotary drives			
	DSM 6, DRVS 6	25	★ 2619969	SRBS-Q12-6-E270-EP-1-S-M8
	DSM 8, DRVS 8	30	★ 2619972	SRBS-Q12-8-E270-EP-1-S-M8
	DSM 10	35	★ 2412001	SRBS-Q1-10-E270-EP-1-S-M8
	DRVS 12	42	★ 2393546	SRBS-Q12-12-E270-EP-1-S-M8
	DRVS 16	55	★ 2393547	SRBS-Q12-16-E270-EP-1-S-M8
	DRVS 25	60	★ 2393548	SRBS-Q12-25-E270-EP-1-S-M8
	DRVS 32	81	★ 2393549	SRBS-Q12-32-E270-EP-1-S-M8
DRVS 40	120	★ 2393550	SRBS-Q12-40-E270-EP-1-S-M8	

Accessories – Connecting cables

		Cable length [m]	Part no.	Type
	Socket, 4-pin, M8 – open cable end	2.5	541342	NEBU-M8G4-K-2.5-LE4
		5	541343	NEBU-M8G4-K-5-LE4
	Socket, 4-pin, M8 – plug, 4-pin, M8	2.5	554035	NEBU-M8G4-K-2.5-M8G4