

Proximity switch SMT-C1

FESTO

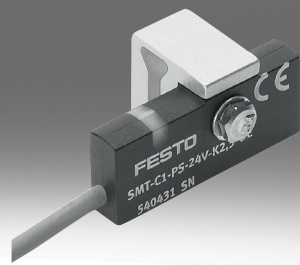

Type code

001	Series
SMT-C1	Proximity switch, block design, magneto-inductive
002	Switching output, switching element function
PS	PNP, N/O contact, 3-wire
003	Rated operating voltage
24V	24 V
004	Version
K	Cable

005	Cable length
10,0	10.0 m
5,0	5.0 m
0,3	0.3 m
006	Electrical connection
M8D	Cable with plug M8x1, rotatable thread
OE	Open end
M12	Cable with plug M12x1

Datasheet

General technical data

Design	Block design
Mounting position	optional
Based on standard	EN 60947-5-2
Approval	RCM trademark
CE mark (see declaration of conformity)	To EU EMC Directive, In accordance with EU RoHS Directive
CE marking (see declaration of conformity)	To UK RoHS instructions, To UK instructions for EMC
Note on materials	RoHS-compliant, Free of halogen
LABS (PWIS) conformity	VDMA24364-B2-L

Input signal/measuring element

Measured variable	Position
Measuring principle	Magneto-inductive
Ambient temperature	-20 ... 70°C
Ambient temperature with moving cable	-20 ... 70°C

Switching output

Switching output	PNP
Switching element function	N/O contact
Hysteresis	≤2 mm
Repetition accuracy	–
Switch-on time	≤0.5 ms
Switch-off time	≤0.5 ms
Max. switching frequency	–
Max. output current	200 mA
Max. switching capacity DC	6 W
Voltage drop	<1.8 V
Inductive protective circuit	Adapted to MZ, MY, ME coils

Output, additional data

Short circuit current rating	Pulsed
Overload protection	Available

Electronics

Operational voltage range DC	10 ... 30 V
Residual ripple	10%
Reverse polarity protection	For all electrical connections

Electromechanical systems

Electrical connection 1, connection type	Cable	Cable with plug
Electrical connection 1, function	Power supply, Switching output	
Electrical connection 1, connector system	Open end	M12x1, A-coded to EN 61076-2-101, M8x1, A-coded, to EN 61076-2-104
Electrical connection 1, number of connections/cores	3	
Electrical connection 1, used connections/cores	3	
Connection outlet orientation	In-line	
Cable length	5 ... 10 m	0.3 m
Cable characteristic	–	
Cable sheath colour	grey	
Material cable sheath	TPE-O	
Material insulating sheath	–	
Wire ends	Wire end sleeve	–

Datasheet

Display/operation

Switching status indication	Yellow LED
-----------------------------	------------

Mechanics

Electrical connection 1, connection type	Cable	Cable with plug
Type of mounting	Clamped	
Product weight	65.9 ... 114.5 g	24.4 ... 32.6 g
Material housing	Wrought aluminium alloy, Brass, nickel-plated, PP, TPE-O, TPE-U(PU), High-alloy stainless steel	
Housing colour	Black	

Immission/emission

Degree of protection	IP65, IP68, To IEC 60529
Corrosion resistance class CRC ¹⁾	2 - Moderate corrosion stress, 3 - High corrosion stress

1) More information: www.festo.com/x/topic/crc

Dimensions

Dimensions – SMT-C1

Download CAD data → www.festo.com

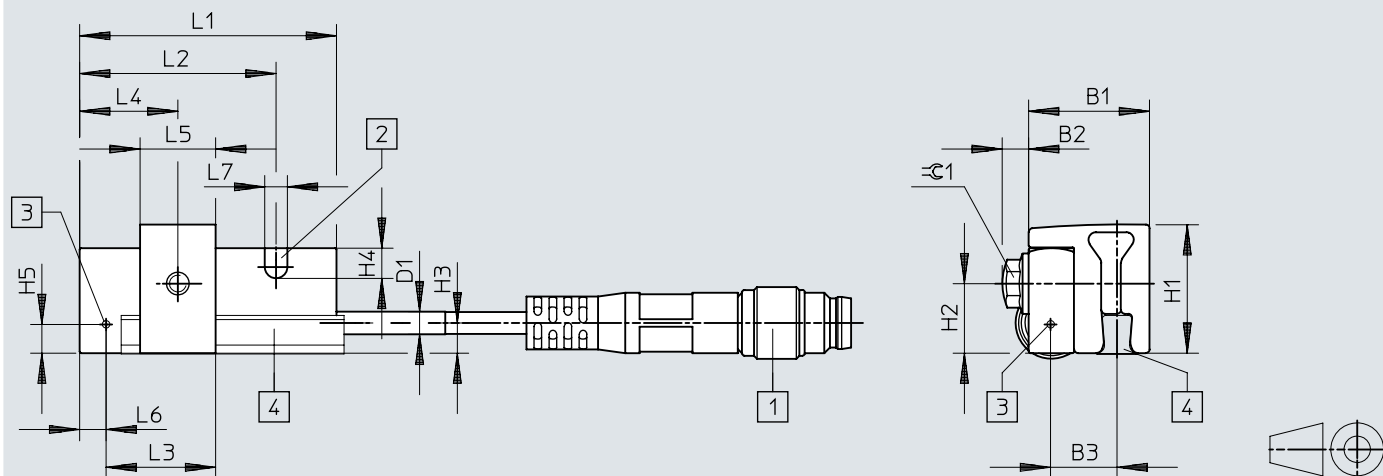

- [1] Example: M8 plug
- [2] Yellow light emitting diode
- [3] Theoretical switching point
- [4] Attachment rail on the drive

	B1	B2	B3	D1	H1	H2	H3	H4	H5	L1	L2	L3	L4	L5	L6	L7	∅C1
SMT-C1	16	3,5	8,8	3	17	9,2	4	4	3,8	34	26	14,5	13	10	3,5	3	5,5

Ordering data

Ordering data						
	Electrical connection 1, connection type	Electrical connection 1, number of connections/cores	Switching output	Cable length	Part no.	Type
	Cable	3	PNP	5 m	571339	SMT-C1-PS-24V-K-5,0-OE
				10 m	571340	SMT-C1-PS-24V-K-10,0-OE
	Cable with plug			0.3 m	571341	SMT-C1-PS-24V-K-0,3-M12
					571342	SMT-C1-PS-24V-K-0,3-M8D

Peripherals

Peripherals overview

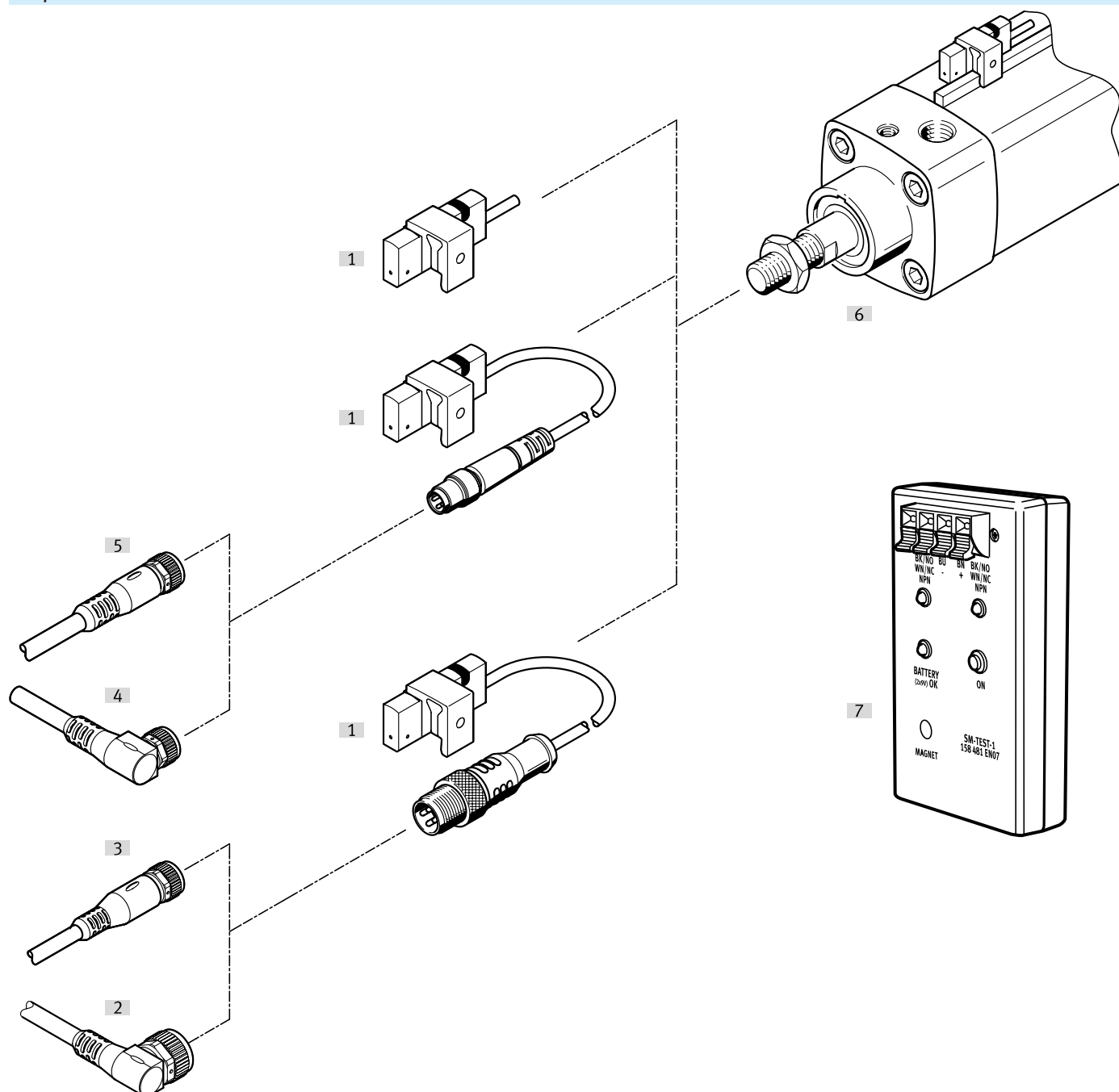

Accessories			→ Page/Internet
Type/order code	Description		
[1] Proximity switch SMT-C1, magnetic inductive, with cable and clamping piece	Magnetic inductive, with cable and clamping piece		smt-c1
[1] Proximity switch SMT-C1, magneto-inductive, with cable and plug M8x1 and clamping piece	Magnetic inductive, with cable and plug M8x1 and clamping piece		smt-c1
[1] Proximity switch SMT-C1, magneto-inductive, with cable and plug M12x1 and clamping piece	Magnetic inductive, with cable and plug M12x1 and clamping piece		smt-c1
[2] Connecting cable NEBU, socket M12x1, 5-pin, angled	Angled socket, M12x1, 5-pin,		9
[3] Connecting cable NEBU, socket M12x1, 5-pin, straight	Straight socket, M12x1, 5-pin		9
[4] Connecting cable NEBU, socket M8x1, 3-pin, angled	Angled socket, M8x1, 3-pin		9

Peripherals

Accessories		→ Page/Internet
Type/order code	Description	
[5] Connecting cable NEBU, socket M8x1, 3-pin, straight	Straight socket, M8x1, 3-pin	9
[6] Standards-based cylinder DSBF-C or CDN-...-R with sensor rail	Ø 32 ... 100 mm	–
[7] Sensor tester SM-TEST-1	Checking that the proximity switches are functioning using the built-in voltage source. Adjusting proximity switches on the cylinder	sm-test-1

Accessories

Connecting cable NEBU, socket M8x1, 3-pin, angled

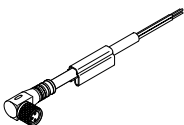
	Connection technology left, field device side	Electrical connection 1, cable outlet	Connection technology right, controller side	Cable length [m]	Part no.	Type
	Socket M8x1 A-coded, EN 61076-2-104	Angled	Open end	2.5 m	★ 541338	NEBU-M8W3-K-2.5-LE3
				5 m	★ 541341	NEBU-M8W3-K-5-LE3

Connecting cable NEBU, socket M8x1, 3-pin, straight

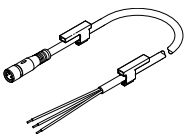
	Connection technology left, field device side	Electrical connection 1, cable outlet	Connection technology right, controller side	Cable length [m]	Part no.	Type
	Socket M8x1 A-coded, EN 61076-2-104	Straight	Open end	2.5 m	★ 541333	NEBU-M8G3-K-2.5-LE3
				5 m	★ 541334	NEBU-M8G3-K-5-LE3

Connecting cable NEBU, socket M12x1, 5-pin, angled

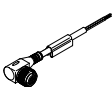
	Connection technology left, field device side	Electrical connection 1, cable outlet	Connection technology right, controller side	Cable length [m]	Part no.	Type
	Socket M12x1 A-coded, EN 61076-2-101	Angled	Open end	2.5 m	541367	NEBU-M12W5-K-2.5-LE3
				5 m	541370	NEBU-M12W5-K-5-LE3

Connecting cable NEBU, socket M12x1, 5-pin, straight

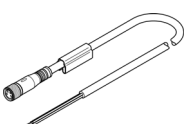
	Connection technology left, field device side	Electrical connection 1, cable outlet	Connection technology right, controller side	Cable length [m]	Part no.	Type
	Socket M12x1 A-coded, EN 61076-2-101	Straight	Open end	2.5 m	★ 541363	NEBU-M12G5-K-2.5-LE3
				5 m	★ 541364	NEBU-M12G5-K-5-LE3

Sensor tester SM-Test-1

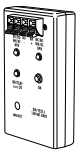
	Operational voltage range DC	Ambient temperature	Degree of protection	Part no.	Type
	12 ... 20 V	0 ... 40 °C	IP20	158481	SM-TEST-1