

Proximity sensors SME-10M, for C-slot



Festo Core Range
Solves the majority of your automation tasks

With the Festo Core Range, we have selected the most important products and functions from our broad product catalogue, and added the quickest delivery.

Worldwide: Quickest delivery – wherever, whenever
Simply good: Expected high Festo quality
Fast: Easy and fast to select

The Core Range offers you the best value for your automation tasks.



Product range overview

Design	Type of mounting	Measuring principle	Type	Operating voltage range	Switching output	Switching element function	→ Page/ Internet
For C-slot	Standard						
	Inserted in the slot from above, flush with the cylinder profile	Magneto-resistive	SMT-10M	5 ... 30 V DC	PNP	N/O contact	–
					NPN		
					Non-contacting, 2-wire		
	Inserted in the slot lengthwise	Magnetic reed	SME-10M	5 ... 30 V AC/DC	Contacting, bipolar	N/O contact	6
Magneto-resistive		SMT-10G	10 ... 30 V DC	PNP, NPN	N/O contact	–	
	Magnetic reed	SME-10	12 ... 27 V AC/DC	Contacting	N/O contact	–	
For T-slot	Standard						
	Inserted in the slot from above, flush with the cylinder profile	Magneto-resistive	SMT-8M	10 ... 30 V DC	PNP	N/O contact	T-slot
					NPN	N/C contact	
					Magnetic reed	SME-8M	
	N/C contact						
	Inserted in the slot lengthwise, flush with the cylinder profile	Magneto-resistive	SMT-8	10 ... 30 V DC	PNP	N/O contact	
					NPN		
	Inserted in the slot lengthwise, flush with the cylinder profile	Magnetic reed	SME-8	12 ... 30 V AC/DC	Contacting, bipolar	N/O contact	
				3 ... 230 V AC/DC		N/C contact	
				5 ... 250 V AC/DC		N/O contact	
	Inserted in the slot lengthwise	Magneto-resistive	SMT-8G	10 ... 30 V DC	PNP	N/O contact	
		Magneto-resistive	SMT-8-SL	10 ... 30 V DC	PNP	N/O contact	
		Magnetic reed	SME-8-SL	10 ... 30 V AC/DC	Contacting, bipolar	N/O contact	
	Via accessories	Magneto-resistive	SMT0-8E	10 ... 30 V DC	PNP	N/O contact	
					NPN		
		Magnetic reed	SME0-8E	12 ... 30 V DC	Contacting, bipolar	N/O contact	
				3 ... 250 V DC			
			3 ... 230 V AC				
	Corrosion-resistant						
	Inserted in the slot lengthwise, flush with the cylinder profile	Magneto-resistive	CRSMT-8	10 ... 30 V DC	PNP	N/O contact	T-slot
	Welding field immune						
	Via accessories	Magneto-inductive	SMTSO-8E	10 ... 30 V DC	PNP	N/O contact	T-slot
					NPN		
Heat resistant up to 120°C							
Inserted in the slot lengthwise, flush with the cylinder profile	Magnetic reed	SME-8...S6	0 ... 30 V AC/DC	Contacting, bipolar	N/O contact	T-slot	
Via accessories	Magnetic reed	SME0-8E...S6	0 ... 30 V DC	Contacting	N/O contact	T-slot	
			0 ... 30 V AC				

Product range overview

T-slot sensors can be used for drives with T-slot

Exceptions

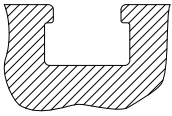

- DFM-B: SMT0-8E, SMTSO-8E, SME0-8E, SMP0-8E cannot be used
- DHDS: SME-8M can only be used on $\varnothing 50$
- DHPS: SME-8M can only be used on $\varnothing 20 \dots 35$
- HGDD-63-A: SMT-8M-A cannot be used
- HGPT-B: only SMT-8G can be used for size 40 and upwards
- SDBT-BSW- ... -PU/NU can only be used on a limited number of drive series

C-slot sensors can be used for drives with C-slot

Exceptions

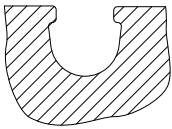

- ADVC $\varnothing 100$: SMT-10M and SME-10M cannot be used (ADVC has a T-slot and a C-slot)
- DSM/DSM-B-6/8/10: SME-10M cannot be used
- DSM/DSM-B-10/16: SMT-10M cannot be used
- HGPT-B: only SMT-10G can be used for sizes up to and including size 35

For drives with sensor rail: these are available with 2 cylinder barrel contours

Only T-slot sensors CRSMT-8M and SMT-8M-A can be used, and only with the suitable profile identified below.

Example: DSBF

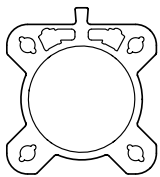

Suitable

Example: CDC

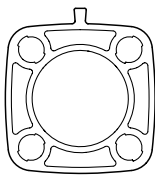

Not suitable

Peripherals overview

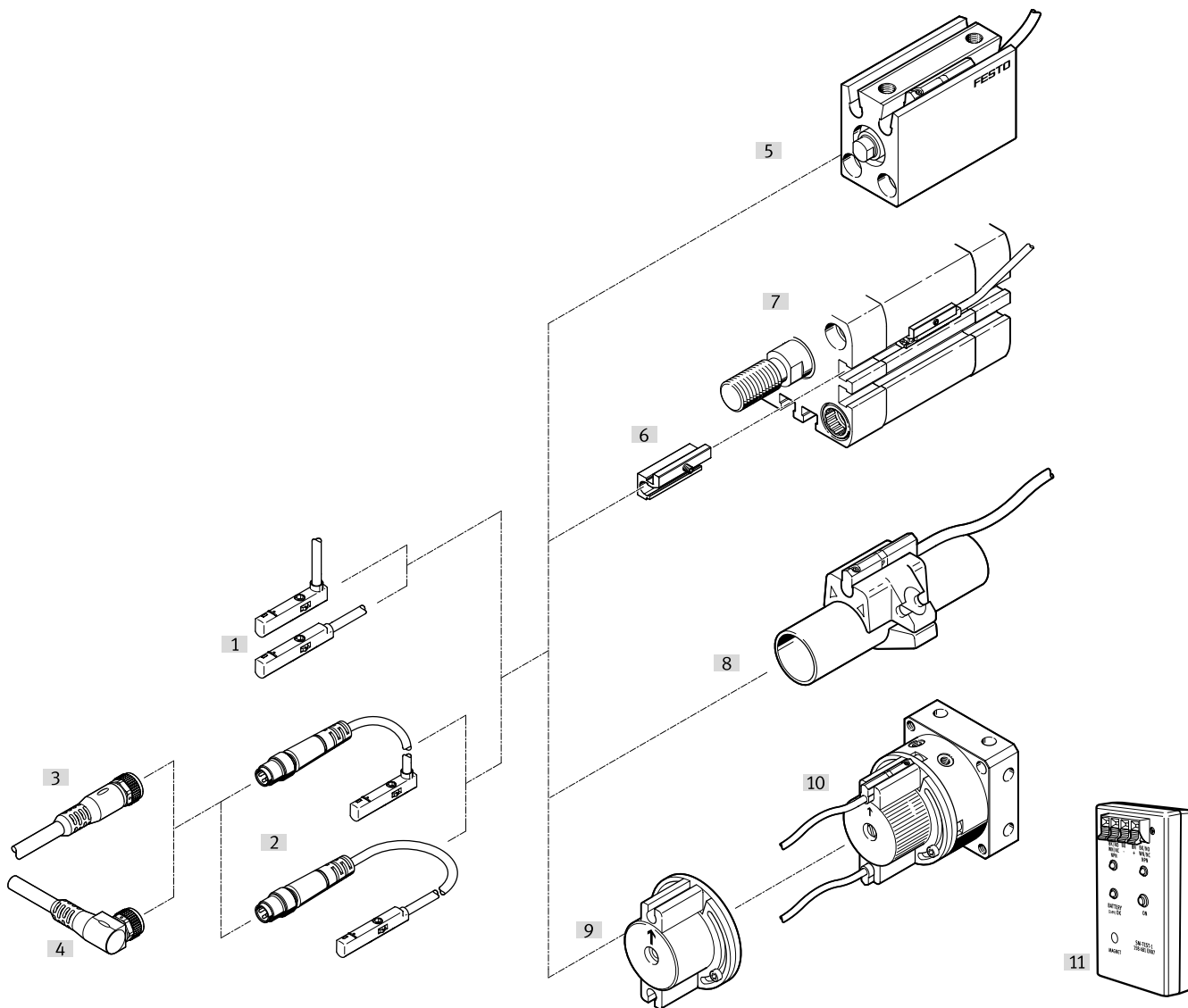

Mounting attachments and accessories		→ Page/ Internet
Proximity sensor		
[1]	SME-10M-...-OE, with cable	6
[2]	SME-10M-...-M..., with cable and plug	6
Connecting cables		
[3]	Connecting cable NEBU-M...G...	13
[4]	Connecting cable NEBU-M...W...	13
Mounting kits		
[6]	Mounting kit SMBN-10	12
[9]	Mounting kit WSM-...-SME-10	13

Mounting attachments and accessories		→ Page/ Internet
Accessories		
[11]	Sensor tester SM-TEST-1	13
-	Positioning element SMM-10	12
-	Clip SMBK-10	13
-	Inscription label ASLR	13
-	Safety clip NEAU	13
Drives		
[5]	Drives with C-slot	-
[7]	Drives with T-slot	-
[8]	Round cylinders	-
[10]	Semi-rotary drive DSM	-

Type codes

001	Series
SME	Proximity sensor
002	Design type
10	For round slot
003	Sensor version
M	Inserted in the slot from above
004	Switching output
DS	3-wire N/O contact
ZS	2-wire PNP N/O contact
005	Rated operating voltage
24	24 V DC
006	Cable characteristic
	None
E	Suitable for energy chains/robot applications

007	Cable length [m]
	0.2 ... 10 m
0,3	0.3 m
2,5	2.5 m
008	Display
L	LED
009	Cable outlet
Q	Transverse
L	Longitudinal
010	Cable identification
	With label holder
N	Without label holder
011	Connection technology
OE	Open end
M8	M8, snap-on flange
M8D	M8, rotatable thread
M12	M12, rotatable thread

Data sheet – Magnetic reed

Function

e.g. N/O contact, 3-wire, with cable

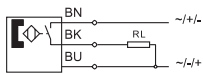

e.g. N/O contact, 3-wire, with plug

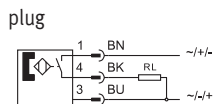

- Magnetic reed measuring principle
- Inserted in the slot from above, does not protrude beyond the cylinder profile
- Cable clip and retaining bracket for inscription labels holders included in the scope of delivery



General technical data	
Design	For C-slot
Conforms to standard	EN 60947-5-2
Certification	RCM trademark
Special characteristics	Oil resistant
Application information	Support / Actuator-sensor overview
CE mark (see declaration of conformity)	To EU EMC Directive ¹⁾
	To EU RoHS Directive
UKCA marking (see declaration of conformity)	To UK instructions for EMC
	To UK RoHS instructions
Note on materials	Halogen-free
	RoHS-compliant
PWIS conformity	VDMA24364-B2-L

1) For information about the area of use, see the EC declaration of conformity at: www.festo.com/sp → Certificates.

If the devices are subject to usage restrictions in residential, commercial or light-industrial environments, further measures for the reduction of the emitted interference may be necessary.

Input signal/measuring element	
Measured variable	Position
Measuring principle	Magnetic reed
Ambient temperature	[°C] -40 ... +70

Switching output			
Type SME-10M	DS	ZS	
Switching output	Contacting, bipolar		
Switching element function	N/O contact		
Switching output repetition accuracy in ± mm	[mm]	0.2	
Switch-on time	[ms]	0 ... 1.2	
Switch-off time	[ms]	0 ... 1	
Max. switching frequency	[Hz]	50	
Max. output current	[mA]	300	100
Max. output current in mounting kits	[mA]	50	50
Max. switching capacity AC	[VA]	9	3
Max. switching capacity AC in mounting kits	[VA]	1.5	1.5
Max. switching capacity DC	[W]	9	3
Max. switching capacity DC in mounting kits	[W]	1.5	1.5
Voltage drop	[V]	0 ... 0.5	0 ... 4.5

Additional output data	
Short circuit current rating	No
Overload protection	Not present

Data sheet – Magnetic reed



Electronics		DS	ZS
Rated operating voltage	[V DC]	24	
Operating voltage range AC	[V]	5 ... 30	
Operating voltage range DC	[V]	5 ... 30	
Reverse polarity protection		No	Bipolar



Electromechanical components			
Type SME-10M		DS	ZS
Electrical connection		OE	M8D M8 M12
Connection type		Cable	Cable with plug
Connection technology		Open end	M8x1, A-coded to EN 61076-2-104 M12x1, A-coded to EN 61076-2-101
Number of pins/wires		3	2
Type of mounting		–	Screw-type lock
Outlet direction of connection		In-line	Lateral
Cable test conditions		Energy chain: 5 million cycles, bending radius 28 mm Torsional resistance: 300,000 cycles, ±270°/0.1 m Resistance to bending: to Festo standard; test conditions on request	
Cable length	[m]	0.2 ... 10	
Cable characteristic		Energy chain + robot	
Information on materials: Cable sheath		TPE-U(PUR)	

Mechanical system	
Type of mounting	Screw-clamped, inserted in the slot from above
Max. tightening torque	0.4
Mounting position	Any
Housing	PA-reinforced High-alloy stainless steel

Display/operation	
Switching status indication	Yellow LED

Immission/emission	
Ambient temperature with flexible cable installation	[°C] –20 ... +70
Degree of protection	IP65 IP68

Pin allocation to EN 60947-5-2			
M8x1, 2-pin N/O contact		M8x1, 3-pin N/O contact	
	Pin	Wire colour	Allocation
	1	Brown	+
	4	Black	Output
	Pin	Wire colour	Allocation
	1	Brown	+
	3	Blue	–
	4	Black	Output

Pin allocation to EN 60947-5-2			
M12x1, 2-pin N/O contact		M12x1, 3-pin N/O contact	
	Pin	Wire colour	Allocation
	1	Brown	+
	4	Black	Output
	Pin	Wire colour	Allocation
	1	Brown	+
	3	Blue	–
	4	Black	Output

Data sheet – Magnetic reed

Dimensions

Download CAD data → www.festo.com

SME-10M-...-L, in-line connection direction

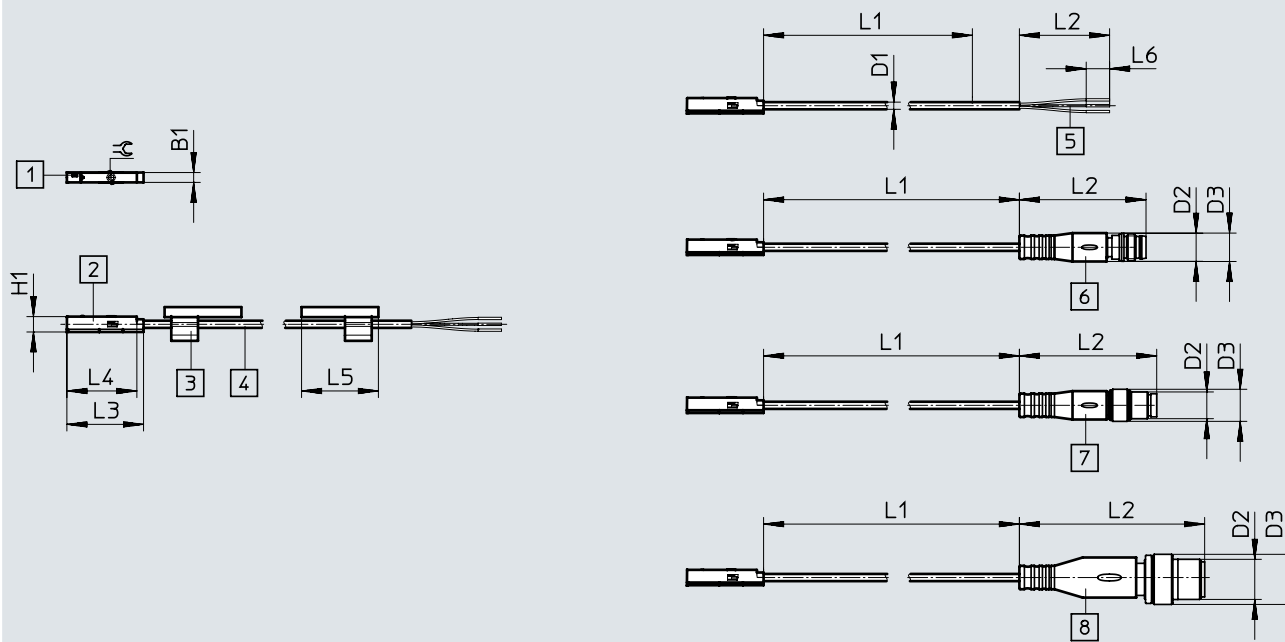

- [1] Yellow LED
- [2] SME-10M
- [3] Inscription label holder
- [4] Connecting cable
- [5] Cable with open end
- [6] Plug M8x1, snap-on flange
- [7] Plug M8x1, rotatable thread
- [8] Plug M12x1
- L1 Cable length

Type	B1	D1	D2	D3	H1	L2	L3	L4	L5	L6	L7	⌀
SME-10M-...-OE	3	2.15	-	-	4.6	50	26.6	24.6	23	50	7	1.5
SME-10M-...-M8D			M8x1	8.5		-						
SME-10M-...-M8			M8x1	9.6		-						
SME-10M-...-M12			M12x1	15		-						

Data sheet – Magnetic reed

Dimensions

Download CAD data → www.festo.com

SME-10M-...-Q, lateral connection direction

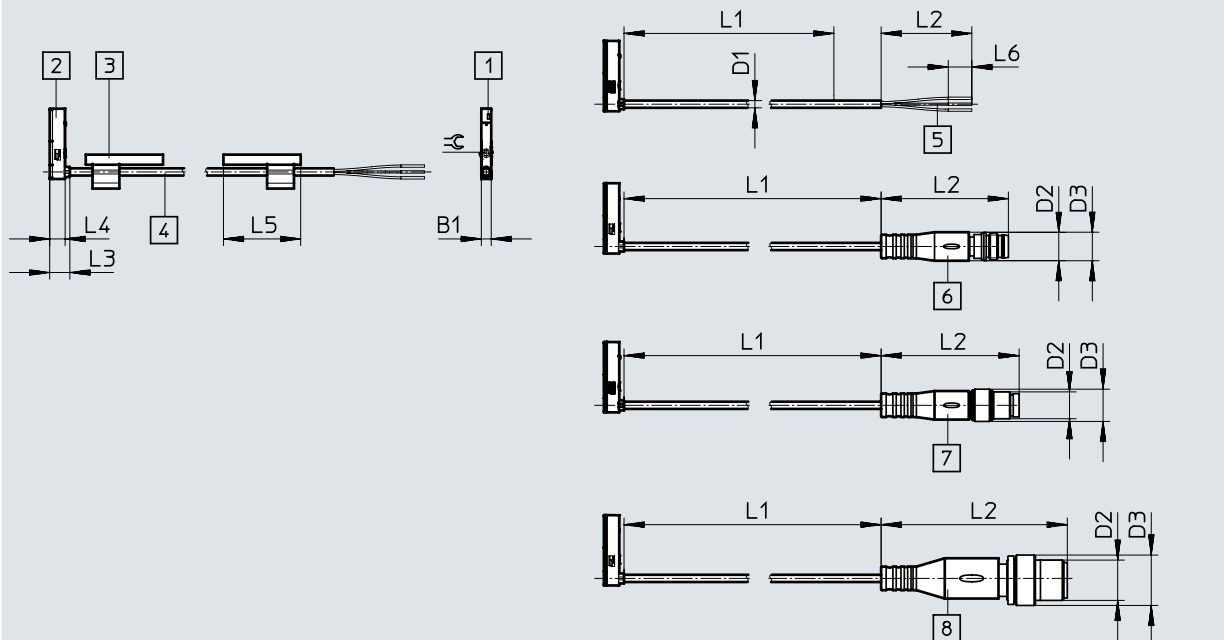

- | | | | |
|------------------------------|-------------------------------|---------------------------------|-----------------|
| [1] Yellow LED | [5] Cable with open end | [7] Plug M8x1, rotatable thread | L1 Cable length |
| [2] SME-10M | [6] Plug M8x1, snap-on flange | [8] Plug M12x1 | |
| [3] Inscription label holder | | | |
| [4] Connecting cable | | | |

Type	B1	D1	D2	D3	H1	L2	L3	L4	L5	L6	L7	⌀
SME-10M-...-OE	3	2.15	-	-	24.6	50	6	4.6	23	50	7	1.5
SME-10M-...-M8D			M8x1	8.5		32.7					-	
SME-10M-...-M8			M8x1	9.6		41.1					-	
SME-10M-...-M12			M12x1	15		55.5					-	

★ Core product range

Ordering data	Switching output	Electrical connection		Cable length [m]	Weight [g]	Part no.	Type	
		Cable	Cable with plug, rotatable thread					
	N/O contact	Contacting, bipolar	3-wire	-	2.5	16.8	★ 551365	SME-10M-DS-24V-E-2.5-L-OE
			-	M8x1, 3-pin	0.3	6.7	★ 551367	SME-10M-DS-24V-E-0.3-L-M8D
			2-wire	-	2.5	14.6	★ 551369	SME-10M-ZS-24V-E-2.5-L-OE

Data sheet – Magnetic reed

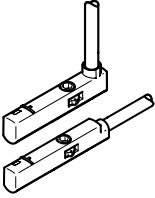
Ordering data	Switching output	Electrical connection		Cable length [m]	Weight [g]	Part no.	Type
		Cable	Cable with plug, rotatable thread				
	N/O contact Contacting, bipolar	3-wire	–	2.5	16.8	551366	SME-10M-DS-24V-E-2.5-Q-OE
		–	M8x1, 3-pin	0.3	6.7	551368	SME-10M-DS-24V-E-0.3-Q-M8D
		2-wire	–	2.5	14.6	551370	SME-10M-ZS-24V-E-2.5-Q-OE

Ordering data – Modular product system, magnetic reed

Ordering table		Conditions	Code	Enter code
Size	10			
Module no.	551364			
Function	Proximity sensor for C-slot, contacting		SME-10M	SME-10M
			–	–
Switching output	3-wire N/O contact		DS	
Switching output	2-wire N/O contact		ZS	
			–	–
Rated operating voltage [V DC]	24		24V	24V
			–	–
Cable characteristic	Energy chain + robot		E	E
			–	–
Cable length [m]	0.2 ... 10 (0.2 ... 5.0 m in 0.1 m increments, 5.0 ... 10 m in 0.5 m increments)		...	
			–	–
Cable outlet	In-line		L	
	Lateral		Q	
			–	–
Cable designation	With inscription label holder		–	
	Without inscription label holder		N	
			–	–
Connection technology	Open end		OE	
	M8, rotatable thread		M8D	
	M8, snap-on flange		M8	
	M12, rotatable thread		M12	

Accessories

Mounting SMBN-10

for mounting proximity sensors
SME/SMT-10 on drives with T-slot

Material:
Rail: Anodised wrought aluminium alloy
Screws: High-alloy stainless steel
Note on materials:
Free of copper and PTFE
RoHS-compliant

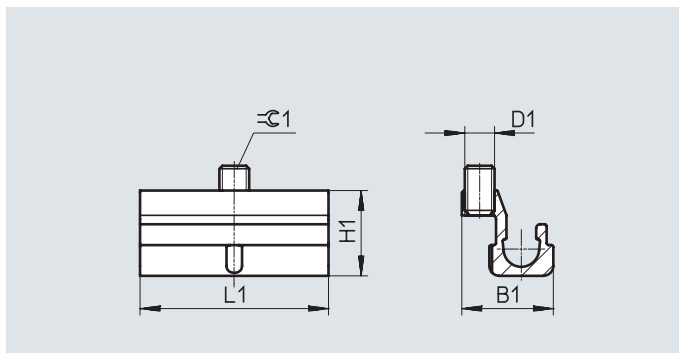

Dimensions and ordering data

For piston \varnothing	D1	B1	H1	L1	$\varnothing 1$	Part no.	Type
125 ... 320	M3	9.3	8.6	19	1.5	537809	SMBN-10

Positioning element SMM

Inserted in the slot lengthwise

Ambient temperature: $-40 \dots +120^{\circ}\text{C}$

Materials:
Housing: Anodised wrought aluminium alloy
Screws: High-alloy stainless steel
Note on materials:
RoHS-compliant

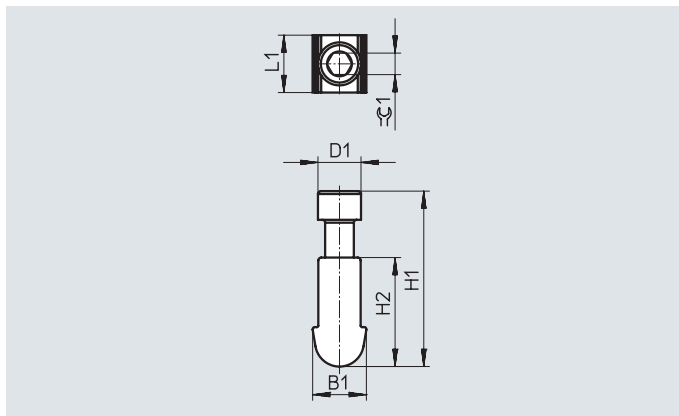

Dimensions and ordering data



B1	D1	H1	H2	L1	$\varnothing 1$	CRC ¹⁾	Part no.	Type	PU ²⁾
3.75	3.0	12.23	7.6	4.0	1.5	3	547942	SMM-10	10

- 1) Corrosion resistance class CRC 3 to Festo standard FN 940070
High corrosion stress. Outdoor exposure under moderate corrosive conditions. External visible parts in direct contact with the ambient atmosphere typical for industrial applications, with primarily functional requirements for the surface.
- 2) Packaging unit



Accessories

Ordering data – Connecting cables

Data sheets → Internet: nebu

	Type	Number of wires	Cable length [m]	Part no.	Type
Socket M8x1, 3-pin					
	For SMT/SME-10...	3	2.5	★ 541333	NEBU-M8G3-K-2.5-LE3
			5	★ 541334	NEBU-M8G3-K-5-LE3
	For SMT/SME-10...	3	2.5	★ 541338	NEBU-M8W3-K-2.5-LE3
			5	★ 541341	NEBU-M8W3-K-5-LE3

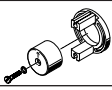
Ordering data – Mounting components

	For Ø	Description	Part no.	Type
	6	Mounting kit for mounting proximity sensors on semi-rotary drives DSM	173205	WSM-6-SME-10
	8		173206	WSM-8-SME-10
	10		173207	WSM-10-SME-10
	–	For fixing connecting cables in place	534255	SMBK-10

Ordering data – Safety clips for ATEX zone

	Size	Description	Part no.	Type	PU ¹⁾
	M8	<ul style="list-style-type: none"> Protects "equipment that is not intrinsically safe" in zones 2 and 22 against simple disconnection ATEX category: gas: II 3G / dust: II 3D 	548067	NEAU-M8-GD	1
	M12		548068	NEAU-M12-GD	1

1) Packaging unit

Ordering data – Sensor testers

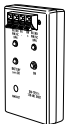
	Description	Part no.	Type
	<ul style="list-style-type: none"> Testing the functionality of proximity sensors using the integrated voltage supply Adjusting the proximity switches on the cylinder 	158481	SM-TEST-1

Ordering data – Inscription labels

	Size	Part no.	Type	PU ¹⁾
	23x4 mm	541598	ASLR-L-423	34

1) Packaging unit

Festo - Your Partner in Automation



1 Festo Inc.
5300 Explorer Drive
Mississauga, ON L4W 5G4
Canada

Festo Customer Interaction Center
Tel: 1 877 463 3786
Fax: 1 877 393 3786
Email: customer.service.ca@festo.com

2 Festo Pneumatic
Av. Ceylán 3,
Col. Tequesquináhuac
54020 Tlalneantla,
Estado de México

Multinational Contact Center
01 800 337 8669
ventas.mexico@festo.com

3 Festo Corporation
1377 Motor Parkway
Suite 310
Islandia, NY 11749

Festo Customer Interaction Center
1 800 993 3786
1 800 963 3786
customer.service.us@festo.com

4 Regional Service Center
7777 Columbia Road
Mason, OH 45040

Connect with us



www.festo.com/socialmedia



www.festo.com

Subject to change