

## Linear drives SLM, with guide

**FESTO**



## Key features

### Version

The linear drive SLM is a combination of a slide unit and a rodless linear drive. The drive moves the slide. The movement is transferred via a magnetic coupling. The modular system enables customised end-position cushioning and end-position sensing solutions.

### Basic unit

#### SLM-...-G

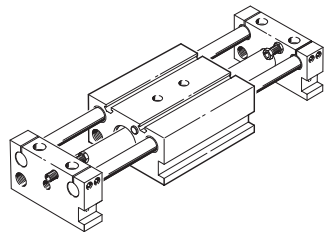

#### SLM-...-GL

With hollow guide rods

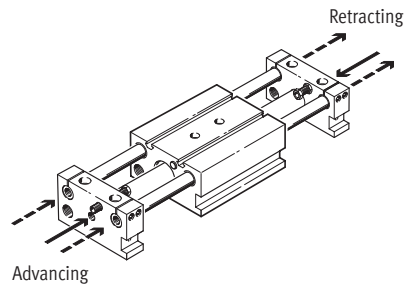

#### SLM-...-GU

With hollow guide rods, air diverting plate and supply port on one side

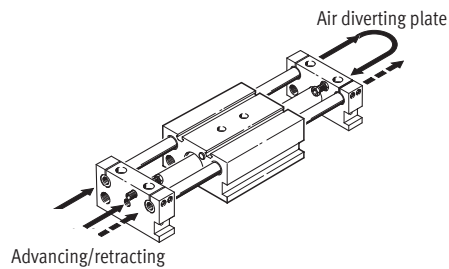

### Standard unit

#### SLM-...-S

With two self-adjusting shock absorbers and two inductive proximity switches with PNP output

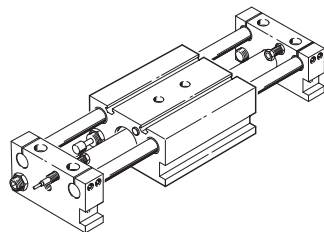

## Type codes

<b>001</b>	<b>Series</b>	
<b>SLM</b>	Linear drive	
<b>002</b>	<b>Piston diameter</b>	
<b>12</b>	12	
<b>16</b>	16	
<b>20</b>	20	
<b>25</b>	25	
<b>32</b>	32	
<b>40</b>	40	
<b>003</b>	<b>Stroke</b>	
<b>...</b>	10 ... 1500	
<b>004</b>	<b>Guide</b>	
<b>KF</b>	Recirculating ball bearing guide	
<b>005</b>	<b>Position sensing</b>	
<b>A</b>	For proximity sensor	
<b>006</b>	<b>Basic unit</b>	
<b>G</b>	Linear drive unit with pneumatic drive	
<b>GL</b>	Linear drive unit with pneumatic drive and hollow guide rods	
<b>GU</b>	Linear drive unit with pneumatic drive and hollow guide rods and reversing plate	
<b>007</b>	<b>Shock absorber at front</b>	
	None	
<b>CV</b>	Shock absorber, self-adjusting, with stop, at front	
<b>YV</b>	Shock absorber, adjustable, with stop at front	

<b>008</b>	<b>Shock absorber at rear</b>	
	None	
<b>CH</b>	Shock absorber, self-adjusting, with stop at rear	
<b>YH</b>	Shock absorber, adjustable, with stop at rear	
<b>009</b>	<b>Sensor at front</b>	
	None	
<b>PV</b>	Inductive proximity sensor, PNP, cable 2.5 m, stop sleeve, at front	
<b>NV</b>	Inductive proximity sensor, NPN, 2.5 m cable, stop sleeve, at front	
<b>010</b>	<b>Sensor at rear</b>	
	None	
<b>PH</b>	Inductive proximity sensor, PNP, cable 2.5 m, stop sleeve, rear	
<b>NH</b>	Inductive proximity sensor, NPN, cable 2.5 m, stop sleeve, at rear	
<b>011</b>	<b>Stroke adjustment at front</b>	
	None	
<b>HV</b>	Stop plate at front	
<b>012</b>	<b>Stroke adjustment at rear</b>	
	None	
<b>HH</b>	Stop plate at rear	
<b>013</b>	<b>Mounting rail</b>	
	None	
<b>E</b>	Mounting rail	
<b>014</b>	<b>Slot nut</b>	
	None	
<b>...I</b>	1 ... 10 units	

Peripherals overview

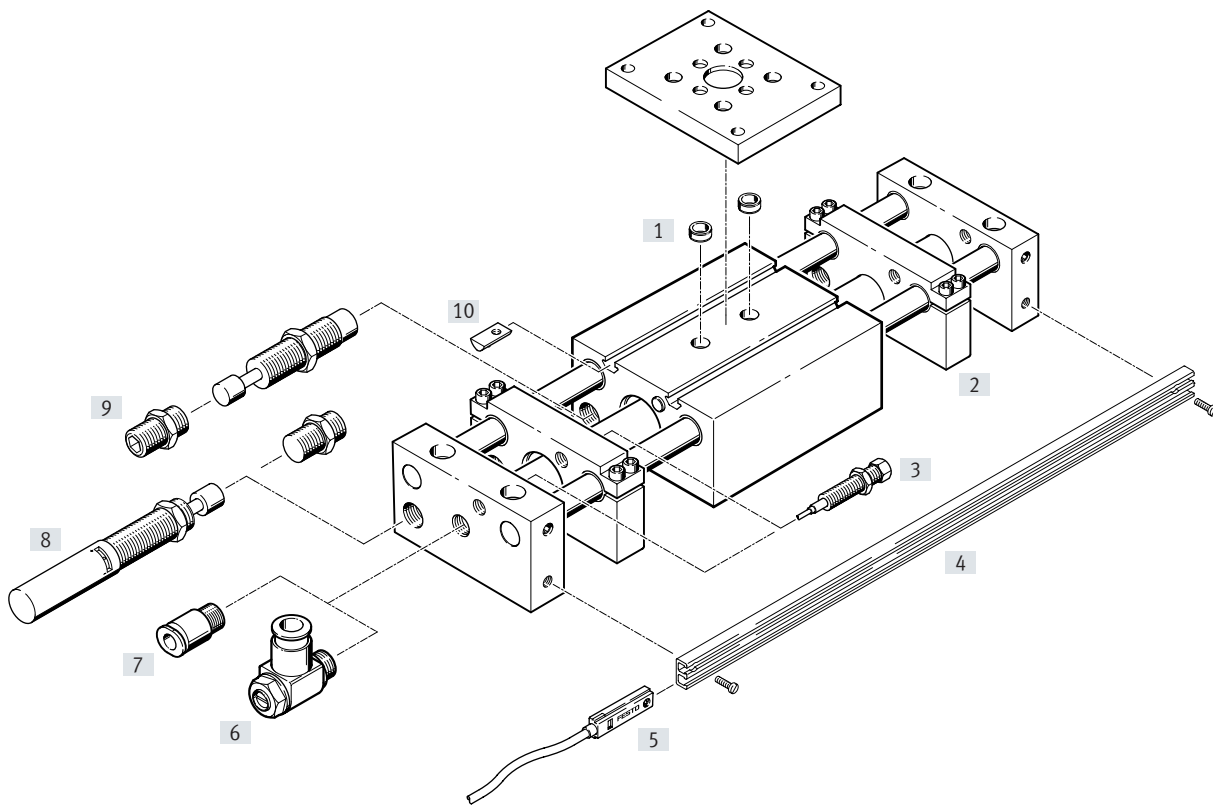

Accessories	Description	→ Page/Internet
[1] Centring sleeve ZBH	For centring loads and attachments on the slide	13
[2] Stop plate SLM...-KF-A	For variable stroke adjustment	13
[3] Switching stop with proximity switch SL...-SIE-PS/SL...-SIE-NS	Can be integrated into the end or stop plate	12
[4] Profile strip SLZS/SLMS	For mounting proximity switches SME/SMT-8	13
[5] Proximity switch SME/SMT-8	Can be integrated in the profile strip SLZS/SLMS	13
[6] One-way flow control valve GRLA	For regulating speed	15
[7] Push-in fitting QS	For connecting tubing with standard O.D.	qs
[8] Shock absorber kit, adjustable SLZ...-KF-A	Higher speeds can be decelerated using shock absorbers	12
[9] Shock absorber kit, self-adjusting SLZ...-YSR-C	Higher speeds can be decelerated using shock absorbers	12
[10] Slot nut NST	For mounting loads and attachments on the slide	13

## Datasheet

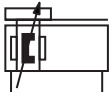

- Diameter  
12 ... 40 mm
- Stroke length  
10 ... 1500 mm

[www.festo.com](http://www.festo.com)

Repair service

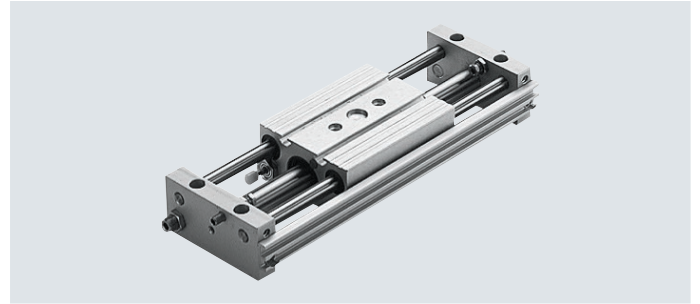
**General technical data**

Piston $\varnothing$	12	16	20	25	32	40
Stroke [mm]	10 ... 500	10 ... 800		10 ... 1500		
Pneumatic connection	M5		G1/8		G1/4	
Operating mode	Double-acting					
Design	Slide unit					
	Rodless linear drive					
End-position cushioning via shock absorber	Self-adjusting at both ends					
	-		-		Adjustable at both ends	
Position sensing	For proximity switch					
Type of mounting	Via through-hole					
	With female thread					
Mounting position	Any					
Protection against rotation/guide	Guide rods with slide/ball guide					

**Operating and environmental conditions**

Piston $\varnothing$	12	16	20	25	32	40
Operating medium	Compressed air to ISO 8573-1:2010 [7:-:-]					
Note on the operating/pilot medium	Lubricated operation possible (in which case lubricated operation will always be required)					
Operating pressure [bar]	$\leq 7$					
Ambient temperature <sup>1)</sup> [°C]	-20 ... +60					

1) Note operating range of proximity switches.

**Forces [N]**

Piston $\varnothing$	12	16	20	25	32	40
Theoretical force at 6 bar, advancing	68	121	188	295	483	754
Theoretical force at 6 bar, retracting	68	121	188	295	483	754
Breakaway force of the magnetic coupling	100	160	270	400	680	1050

Datasheet

Permissible dynamic load

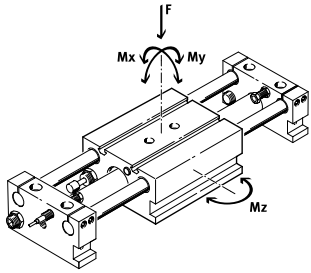

$F = \text{load}$   
 $M \geq M_x$   
 $M \geq M_y$   
 $M \geq M_z$

Permissible payload F as a function of stroke l

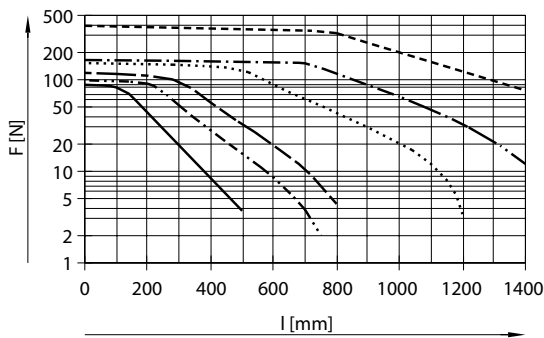

- SLM-12
- ..... SLM-16
- SLM-20
- ..... SLM-25
- · - · SLM-32
- SLM-40

Permissible torque M as a function of stroke l

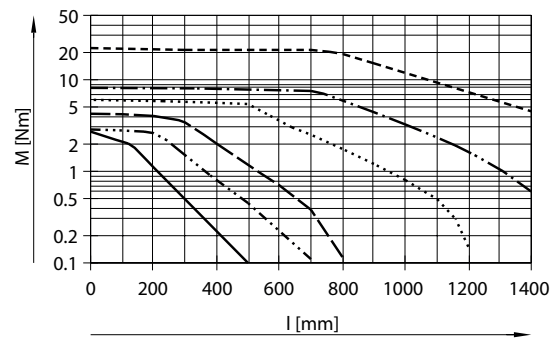

- SLM-12
- ..... SLM-16
- SLM-20
- ..... SLM-25
- · - · SLM-32
- SLM-40

Permissible shock absorber load F as a function of impact velocity v

With horizontal installation

$F \geq m_L \times g$

$g = 9.81 \text{ N/mm}^2$   
 $m_L = \text{load [kg]}$

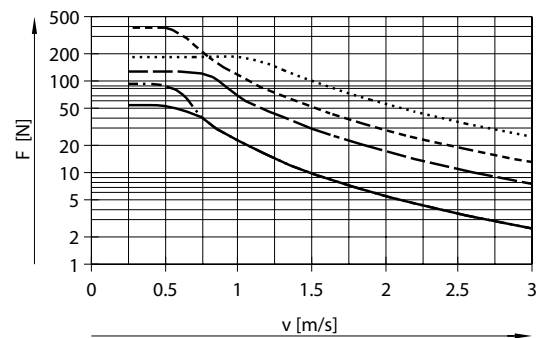

- SLM-12
- ..... SLM-16
- SLM-20
- ..... SLM-25
- · - · SLM-32
- SLM-40

With vertical installation

$F \geq (m_L + m_E) \times g$

$g = 9.81 \text{ N/mm}^2$   
 $m_E = \text{moving mass (dead weight) [kg]}$   
 $m_L = \text{load [kg]}$

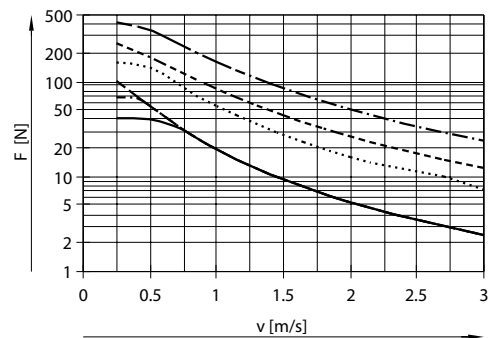

- SLM-12
- ..... SLM-16
- SLM-20
- ..... SLM-25
- · - · SLM-32
- SLM-40

## Datasheet

Weight [g]						
Piston $\varnothing$	12	16	20	25	32	40
Basic weight with 0 mm stroke	1110	1730	2620	3800	6400	9550
Additional weight per 10 mm stroke	10	15	21	36	55	85
Moving mass	620	1080	1400	2150	3150	5080

### Materials

#### Sectional view

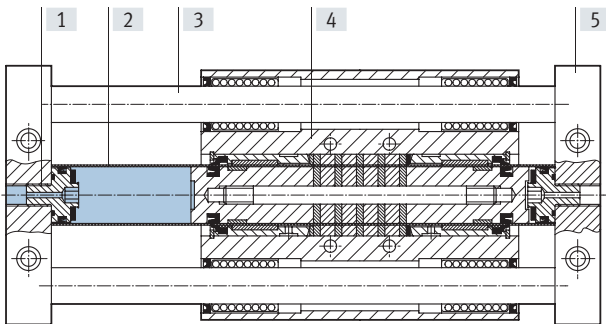

#### Linear drive

[1]	Cylinder barrel attachment	Wrought aluminium alloy
[2]	Cylinder barrel	High-alloy stainless steel
[3]	Guide rod	Steel
[4]	Slide	Wrought aluminium alloy
[5]	End plate	Wrought aluminium alloy
-	Stop plate	Wrought aluminium alloy
-	Seals	NBR

Datasheet

Dimensions

Download CAD data → [www.festo.com](http://www.festo.com)

View A

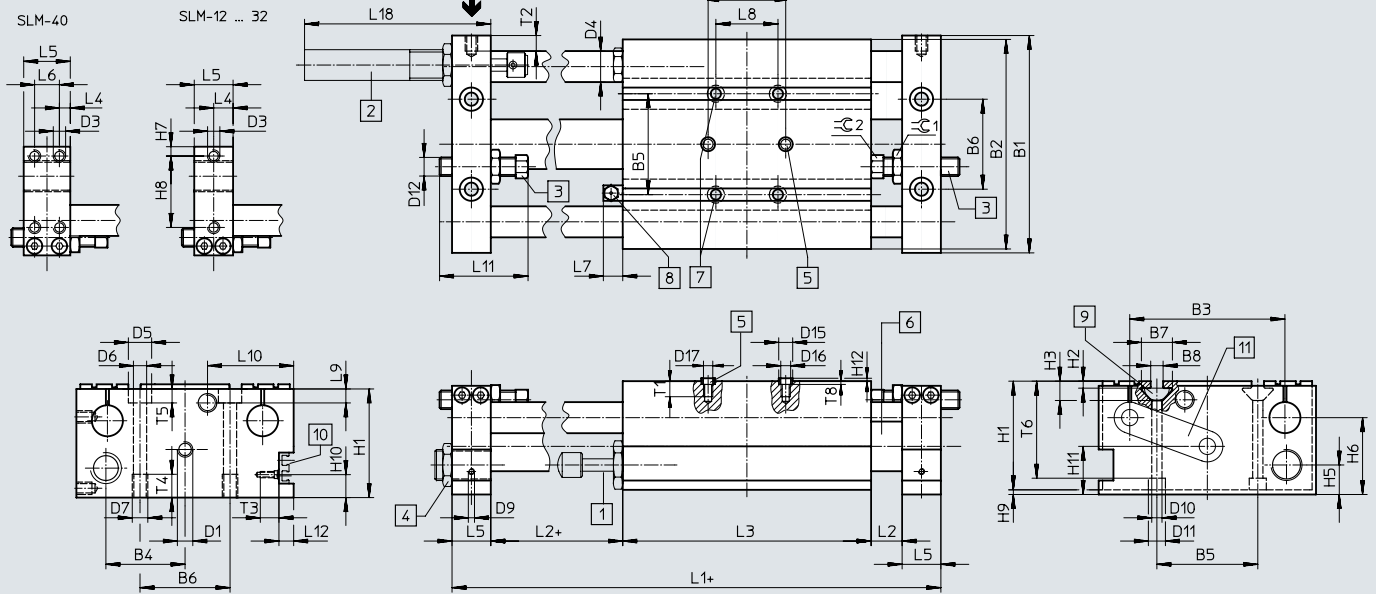

- [1] Self-adjusting shock absorber, for front and rear mounting
  - [2] Adjustable shock absorber, for front and rear mounting on the end plate
  - [3] Switching stop with proximity switch, PNP/NPN, for front and rear mounting
  - [4] Stop for shock absorber
  - [5] Centring sleeves (2 included in scope of delivery)
  - [6] Pneumatic linear drive
  - [7] Mounting thread/through-hole
  - [8] Lubrication nipple
  - [9] Slot nut
  - [10] Mounting rail for proximity switch SME/SMT-8
  - [11] Air diverting plate
- + = plus stroke length

With stop plate

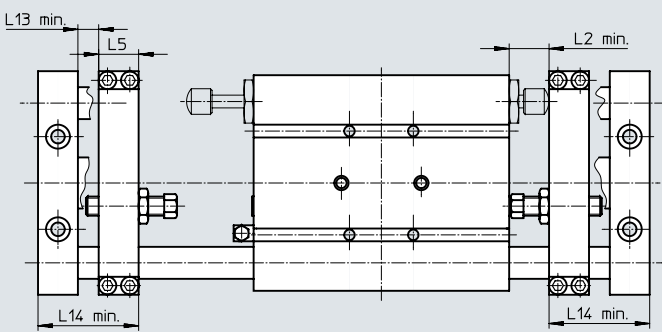

Note

When using the stop plate at the front and/or rear, the stroke is reduced by at least the dimensions L5 and L13 for each side. If using a shock absorber or switching stop with proximity switch at the front and/or rear, the stroke is additionally reduced by at least dimension L2 per side.

With hollow guide rod and air diverting plate

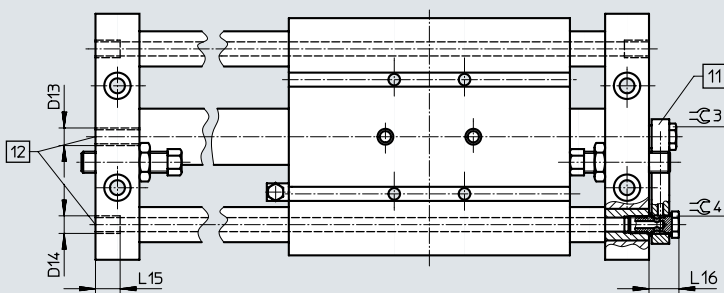

- [11] Air diverting plate
- [12] Compressed air supply port



## Datasheet

∅ [mm]	B1	B2	B3 ±0.03	B4	B5 ±0.2	B6 ±0.2	B7	B8	D1	D3	D4 ∅ h6	D5 ∅	D6 ∅	D7	D9	D10 ∅
12	74	71	52	26.5	26	35	11.6	5	M5	M5	8	10	5.3	M6	M4	5.3
16	84	80	58	31	32	40	11.6	5	M5	M5	10	10	5.3	M6	M4	5.5
20	100	96	72	36.5	40	47	11.6	5	G1/8	M6	12	11	6.8	M8	M4	5.5
25	114	110	80	39.5	45	48	11.6	5	G1/8	M6	16	10.5	6.8	M8	M4	5.5
32	140	135	100	51	65	58	20	8	G1/8	M8	20	15	8.5	M10	M4	6.6
40	166	160	118	63	75	78	20	8	G1/4	M6	25	15	8.5	M10	M4	6.6

∅ [mm]	D11 ∅	D12	D13	D14	D15 ∅ H7	D16 ∅	D17	H1	H2	H3	H5	H6	H7	H8 ±0.2	H9
12	9	M6x0.75	M5	–	9	6.4	M6	38	1.8	6.4	11.5	27	3.5	31	2
16	10	M6x0.75	M5	M5	9	6.4	M6	40	1.8	6.4	12	28.5	4.5	31	2
20	10	M8x1	G1/8	M5	9	6.4	M6	50	1.8	6.4	16	36	5	40	2
25	10	M8x1	G1/8	G1/8	9	6.4	M6	55	1.8	6.4	14	36.5	5	34	2
32	11	M12x1	G1/8	G1/8	9	6.4	M6	70	4.5	12.5	19	49.5	6	46	3
40	11	M12x1	G1/4	G1/4	9	6.4	M6	75	4.5	12.5	19	51	5.5	51.5	3

∅ [mm]	H10	H11	H12	L1	L2	L3	L4	L5	L6	L7	L8 ±0.2	L9	L10	L11	L12	L13
12	16	15.5	1.9	139	12	85	7.5	15	–	11	19	6.5	37	33	–	7
16	16	19	1.9	154	12	100	7.5	15	–	11	32	6	31.5	33	–	7
20	16	22	1.9	192	16	120	10	20	–	12.5	26	8	44	45	–	10
25	16	25	1.9	212	16	140	10	20	–	12.5	26	8	45	45	–	10
32	14.8	31	1.9	250	20	160	12.5	25	–	12.5	40	9	55.5	57	9.5	13
40	15.8	36.5	1.9	270	20	180	6.5	25	12	12.5	50	9	61.5	57	10	13

∅ [mm]	L14	L15	L16	L17 <sup>1)</sup>	L18	T1	T2	T3	T4	T5	T6	T8 +0.2	≈C1	≈C2	≈C3	≈C4
12	37	–	–	40	–	10	7	12	10	5.7	30.5	2.1	10	8	–	–
16	37	8	12.5	40	–	10	6.5	12	10	5.7	34.3	2.1	10	8	13	–
20	50	8	19.5	40	97	10	9	12	12	6.8	44	2.1	13	11	13	8
25	50	10	19.5	40	97	10	9	12	12	6.8	49.3	2.1	13	11	13	–
32	63	14	15.5	40	115	10	10	12	15	9	62.5	2.1	19	13	13	–
40	63	15	17	40	115	10	10	12	16	9	61	2.1	19	13	17	–

1) Tolerance for centring hole ±0.03 mm  
Tolerance for thread ±0.1 mm

Ordering data – Modular product system

Ordering table									
Size	12	16	20	25	32	40	Conditions	Code	Enter code
Module no.	<b>32781</b>	<b>32782</b>	<b>32783</b>	<b>32784</b>	<b>32785</b>	<b>32786</b>			
Function	Linear drive unit							<b>SLM</b>	SLM
Size [mm]	12	16	20	25	32	40		<b>-...</b>	
Stroke [mm]	10 ... 500	10 ... 800		10 ... 1500				<b>-...</b>	
Guide	With linear ball bearings							<b>-KF</b>	-KF
Position sensing	For proximity switch							<b>-A</b>	-A
Basic unit	Linear drive unit with pneumatic drive							<b>-G</b>	
	– Linear drive unit with pneumatic drive and hollow guide rods							<b>-GL</b>	
	– Linear drive unit with pneumatic drive, hollow guide rods and air diverting plate							<b>-GU</b>	
Shock absorber	Front	Self-adjusting shock absorber, with stop at front					<b>-CV</b>		
		–	–	Adjustable shock absorber, with stop at front			<b>-YV</b>		
	Rear	Self-adjusting shock absorber, with stop at rear					<b>-CH</b>		
		–	–	Adjustable shock absorber, with stop at rear			<b>-YH</b>		
Sensor (bonded)	Front	Inductive sensor with 2.5 m cable, PNP, with stop sleeve at front					<b>-PV</b>		
		Inductive sensor with 2.5 m cable, NPN, with stop sleeve at front					<b>-NV</b>		
	Rear	Inductive sensor with 2.5 m cable, PNP, with stop sleeve at rear					<b>-PH</b>		
		Inductive sensor with 2.5 m cable, NPN, with stop sleeve at rear					<b>-NH</b>		
Stroke adjustment	Front	Stop plate at the front					[1]	<b>-HV</b>	
	Rear	Stop plate at the rear					[2]	<b>-HH</b>	
Mounting rail	Mounting rail							<b>-E</b>	
Slot nut	1 ... 10							<b>-...I</b>	

## Ordering data – Modular products, package solution

Ordering table									
Size	12	16	20	25	32	40	Conditions	Code	Enter code
Module no.	<b>32781</b>	<b>32782</b>	<b>32783</b>	<b>32784</b>	<b>32785</b>	<b>32786</b>			
Function	Linear drive unit							<b>SLM</b>	SLM
Size [mm]	12	16	20	25	32	40		-...	
Stroke [mm]	10 ... 500	10 ... 800		10 ... 1500				-...	
Guide	With linear ball bearings							<b>-KF</b>	-KF
Position sensing	For proximity switch							<b>-A</b>	-A
Standard unit	Package solution S = G-CV-CH-PV-PH							<b>-S</b>	-S

## Accessories

### Shock absorber kit SLZ-...-YSR-C, self-adjusting (Order code: CV, CH)

Material:  
YSR-8-8-C: Nickel-plated brass  
YSR-12-12-C, YSR-16-20-C:  
Galvanised steel



Ordering data		Part no.	Type
For $\varnothing$ [mm]	Includes shock absorber Datasheets → Internet: ysr		
12, 16	YSR-8-8-C	115315	SLZ-16-YSR-C
20, 25	YSR-12-12-C	115316	SLZ-25-YSR-C
32, 40	YSR-16-20-C	115317	SLZ-32-YSR-C

### Shock absorber kit SLZ-...-KF-A, adjustable (Order code: YV, YH)

Material:  
Galvanised steel



Ordering data		Part no.	Type
For $\varnothing$ [mm]	Includes shock absorber Datasheets → Internet: dysr		
20, 25	DYSR-12-12-Y5	114032	SLZ-25-KF-A
32, 40	DYSR-16-20-Y5	114033	SLZ-32-KF-A





### Switching stop SL-...-SIE-PS (Order code: PV, PH) Kit with inductive proximity sensor PNP

Switching stop SL-...-SIE-NS  
(Order code: NV, NH)  
Kit with inductive proximity sensor  
NPN

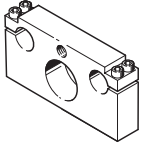

Ordering data		Part no.	Type
For $\varnothing$ [mm]	Switching output	Includes proximity switch Datasheets → Internet: sien	
12, 16	PNP	SIEN-4B-PS-K-L	116251 SL-1 0/16-SIE-PS
	NPN	SIEN-4B-NS-K-L	116252 SL-1 0/16-SIE-NS
20, 25	PNP	SIEN-4B-PS-K-L	116253 SL-2 0/25-SIE-PS
	NPN	SIEN-4B-NS-K-L	116254 SL-2 0/25-SIE-NS
32, 40	PNP	SIEN-6.5B-PS-K-L	117525 SL-3 2/50-SIE-PS
	NPN	SIEN-6.5B-NS-K-L	117526 SL-3 2/50-SIE-NS

## Accessories

Ordering data – Accessories						
	For ø [mm]	Material	Order code	Part no.	Type	PU <sup>1)</sup>
<b>Stop plate SLM-...-KF-A</b>						
	12	Wrought aluminium alloy	HV, HH	119527	SLM-12-...-KF-A	1
	16			119528	SLM-16-...-KF-A	1
	20			119529	SLM-20-...-KF-A	1
	25			119530	SLM-25-...-KF-A	1
	32			119531	SLM-32-...-KF-A	1
	40			119532	SLM-40-...-KF-A	1
<b>Mounting rail SLZS/SLMS for proximity switch</b>						
	12	Wrought aluminium alloy	E	150916	SLZS-16-...-...	1
	16			152744	SLMS-16-...-...	1
	20			150917	SLZS-25-...-...	1
	25			152745	SLMS-25-...-...	1
	32			150918	SLZS-32-...-...	1
	40			150919	SLZS-40-...-...	1
<b>Slot nut NST</b> <span style="float: right;">Datasheets → Internet: nst</span>						
	12 ... 25	Non-alloyed tempered steel	I	150914	NST-5-M5	1
	32, 40			150915	NST-8-M6	1
<b>Centring sleeve ZBH</b> <span style="float: right;">Datasheets → Internet: zbh</span>						
	16 ... 40	Stainless steel	–	8137184	ZBH-9-B	10

1) Packaging unit

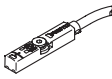
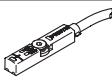
Ordering data – Proximity switch for T-slot, magneto-resistive						
	Type of mounting	Switching output	Electrical connection	Cable length [m]	Part no.	Type
<b>N/O</b> <span style="float: right;">Datasheets → Internet: smt</span>						
	Inserted in the slot from above, flush with the cylinder profile, short design	PNP	Cable, 3-core	2.5	574335	SMT-8M-A-PS-24V-E-2.5-OE
			Plug M8x1, 3-pin	0.3	574334	SMT-8M-A-PS-24V-E-0.3-M8D
			Plug M12x1, 3-pin	0.3	574337	SMT-8M-A-PS-24V-E-0.3-M12
		NPN	Cable, 3-core	2.5	574338	SMT-8M-A-NS-24V-E-2.5-OE
Plug M8x1, 3-pin	0.3		574339	SMT-8M-A-NS-24V-E-0.3-M8D		
<b>N/C</b>						
	Inserted in the slot from above, flush with the cylinder profile, short design	PNP	Cable, 3-core	7.5	574340	SMT-8M-A-PO-24V-E-7.5-OE

Accessories

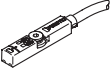
Ordering data – Proximity switch for T-slot, magnetic reed							Datasheets → Internet: sme
	Type of mounting	Switching output	Electrical connection	Cable length [m]	Part no.	Type	
<b>N/O</b>							
	Inserted in the slot from above, flush with the cylinder profile	Contacting	Cable, 3-core	2.5	<b>543862</b>	<b>SME-8M-DS-24V-K-2.5-OE</b>	
				5.0	<b>543863</b>	<b>SME-8M-DS-24V-K-5.0-OE</b>	
			Cable, 2-core	2.5	<b>543872</b>	<b>SME-8M-ZS-24V-K-2.5-OE</b>	
			Plug M8x1, 3-pin	0.3	<b>543861</b>	<b>SME-8M-DS-24V-K-0.3-M8D</b>	

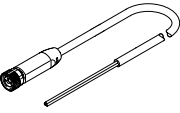
Connecting cables NEBA, straight, M8 connection						
	Electrical connection 1, connection technology	Electrical connection 2, connection technology	Electrical connection 2, number of pins/cores	Cable length	Part no.	Type
	M8x1 A-coded to EN 61076-2-104	Open end	3	2.5 m	<b>8078223</b>	<b>NEBA-M8G3-U-2.5-N-LE3</b>
				5 m	<b>8078224</b>	<b>NEBA-M8G3-U-5-N-LE3</b>

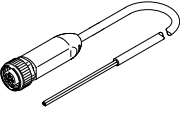
Connecting cables NEBA, straight, M12 connection						
	Electrical connection 1, connection technology	Electrical connection 2, connection technology	Electrical connection 2, number of pins/cores	Cable length	Part no.	Type
	M12x1 A-coded to EN61076-2-101	Open end	3	2.5 m	<b>8078236</b>	<b>NEBA-M12G5-U-2.5-N-LE3</b>
				5 m	<b>8078237</b>	<b>NEBA-M12G5-U-5-N-LE3</b>

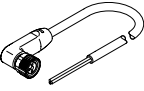
Connecting cables NEBA, angled, M8 connection						
	Electrical connection 1, connection technology	Electrical connection 2, connection technology	Electrical connection 2, number of pins/cores	Cable length	Part no.	Type
	M8x1 A-coded to EN 61076-2-104	Open end	3	2.5 m	<b>8078230</b>	<b>NEBA-M8W3-U-2.5-N-LE3</b>
				5 m	<b>8078231</b>	<b>NEBA-M8W3-U-5-N-LE3</b>

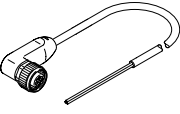
Connecting cables NEBA, angled, M12 connection						
	Electrical connection 1, connection technology	Electrical connection 2, connection technology	Electrical connection 2, number of pins/cores	Cable length	Part no.	Type
	M12x1 A-coded to EN61076-2-101	Open end	3	2.5 m	<b>8078245</b>	<b>NEBA-M12W5-U-2.5-N-LE3</b>
				5 m	<b>8078246</b>	<b>NEBA-M12W5-U-5-N-LE3</b>

## Accessories

Ordering data – Slot cover for T-slot				
	Mounting	Length [m]	Part no.	Type
	Insertable	2x 0.5	151680	ABP-5-S

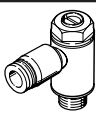
Ordering data – One-way flow control valves					Datasheets → Internet: grla	
	Connection Thread	For tubing O.D.	Material	Part no.	Type	
	M5	3	Metal design	193137	GRLA-M5-QS-3-D	
		4		193138	GRLA-M5-QS-4-D	
		6		193139	GRLA-M5-QS-6-D	
	G1/8	3		193142	GRLA-1/8-QS-3-D	
		4		193143	GRLA-1/8-QS-4-D	
		6		193144	GRLA-1/8-QS-6-D	
		8		193145	GRLA-1/8-QS-8-D	
	G1/4	6		193146	GRLA-1/4-QS-6-D	
		8		193147	GRLA-1/4-QS-8-D	
		10		193148	GRLA-1/4-QS-10-D	