

Servo motors EMMT-AS

FESTO

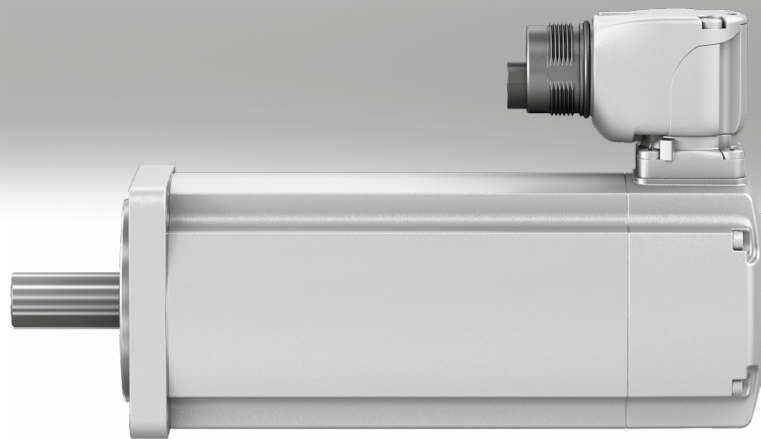

Key features

Everything from a single source

Motors EMMT-AS

→ Page 3



- Dynamic, brushless, permanently excited synchronous servo motors
- Extremely low cogging torque – supports high synchronisation even at low rotational speeds
- Digital absolute displacement encoder; choose from:
 - Single-turn
 - Multi-turn, no batteries
 - Multi-turn safety, no batteries
- Motor temperature transmission, digital via EnDat 2.2; motor protection via CMMT-AS
- Torque-optimised
- Speed-optimised
- Degree of protection:
 - IP21 (motor shaft) for sizes 150/190
 - IP40 (motor shaft)
 - IP67 (motor housing with connection technology)
 - IP65 (motor shaft with rotary shaft seal made from PTFE)
- Optional:
 - Holding brake
 - Shaft with feather key
 - Motor shaft with rotary shaft seal
- Simple connection technology (OCP: one cable plug) – hybrid cable: motor and connecting cable for supply and encoder rolled into one
- Plug can be rotated:
 - page 23

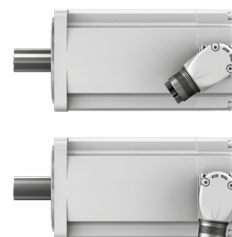

Gear unit EMGA-EAS/-SAS

→ Page 34



- Planetary/right-angle gear unit
- Gear ratio $i = 3, 5, 8, 12, 20$
- Life-time lubrication
- Degree of protection: IP54
- Other gear unit types, ratios, designs and versions on request

Servo drive CMMT-AS

→ Internet: cmmt-as



- Universal servo drive for synchronous servo motors
- Integrated EMC filters
- Integrated brake chopper
- Integrated braking resistor
- Integrated safety functions
- Position controller
- Speed controller
- Force controller
- Range of control functions
- Interfaces:
 - EtherCAT®
 - PROFINET RT/IRT
 - EtherNet/IP
 - Modbus TCP

Motor cables NEBM

→ Page 36



- Suitable for energy chains
- Connection technology on motor side with degree of protection to IP67
- Can be used in a wide temperature range

Axial and parallel kits EAMM

→ Internet: eamm



- Specific kits for all electro-mechanical axes from Festo
- Each kit includes the relevant necessary coupling housing, couplings and motor flange as well as all screws
- Optionally with degree of protection IP65

Type codes

001	Series
EMMT	Servo motor
002	Motor type
AS	AC synchronous
003	Flange size, motors [mm]
60	60
80	80
100	100
150	150
190	190
004	Length
H	Very long
L	Long
M	Medium
S	Short
005	Output shaft
	Smooth shaft
K	Shaft to DIN 6885

006	Radial shaft seal
	None
R	With standard shaft sealing ring
007	Winding
LS	Low voltage, standard
HS	High voltage, standard
HV	High voltage, speed optimised
HT	High voltage, torque optimised
008	Electrical connection
R	Angled plug, rotatable
R2	Angled plug M23, rotatable
R3	Angled plug M40, rotatable
009	Measuring unit
S	Absolute encoder, single turn
M	Absolute encoder, multi-turn
MY	Absolute multi-turn safety encoder, EnDat®
010	Brake
	None
B	With brake

Datasheet



Note
Motors and motor controllers from Festo have been specially designed to be used together. Trouble-free operation cannot be guaranteed in combination with third-party controllers.

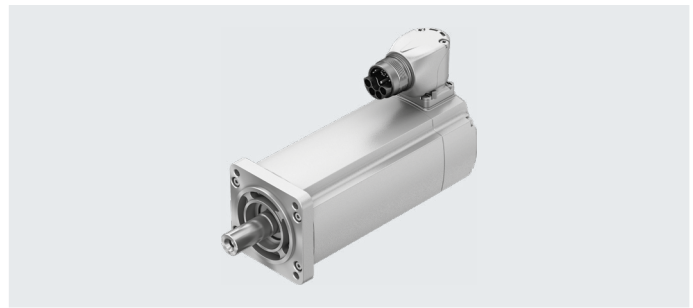

Technical data

Flange size	60						
Length	S		M		L		
Winding	LS	HS	LS	HS	LS	HS	
Nominal operating voltage ¹⁾	[V DC]	325	680	325	680	325	680
Nominal current ²⁾	[A]	1.6/1.4	1.6/1.4	2.4/2.2	2.4/2.2	3.2/3	3.2/3
Continuous stall current ²⁾	[A]	1.7/1.6	1.7/1.6	2.7/2.5	2.7/2.5	3.8/3.5	3.8/3.5
Peak current	[A]	5.4	5.4	11.0	11.0	18.3	18.3
Nominal power ²⁾	[W]	200/190	200/190	350/310	350/310	440/410	440/410
Nominal torque ²⁾³⁾	[Nm]	0.64/0.6	0.64/0.6	1.1/1.0	1.1/1.0	1.4/1.3	1.4/1.3
Peak torque	[Nm]	1.6	1.6	3.4	3.4	5.6	5.6
Stall torque ²⁾	[Nm]	0.7/0.66	0.7/0.66	1.24/1.15	1.24/1.15	1.66/1.56	1.66/1.56
Stall torque constant ⁴⁾	[Nm/A]	0.49	0.49	0.53	0.53	0.52	0.52
Nominal rotational speed	[rpm]	3000					
Max. rotational speed	[rpm]	7100	15000	6800	14200	6800	14300
Max. mechanical rotational speed	[rpm]	16000					
Max. idling rotational speed with brake	[rpm]	10000					
Angular acceleration	[rad/s ²]	≤ 100000					
Motor constant	[Nm/A]	0.41	0.41	0.45	0.45	0.44	0.44
Voltage constant (phase-to-phase)	[mV/min]	29.9	29.9	32	32	31.2	31.2
Electric time constant	[ms]	2.1	2.1	2.7	2.7	3	3
Thermal time constant ²⁾	[min]	40/41	40/41	41/42	41/42	43/44	43/44
Thermal resistance ²⁾	[K/W]	1.3/1.5	1.3/1.5	1.1/1.3	1.1/1.3	1/1.2	1/1.2
Number of pole pairs		5	5	5	5	5	5
Winding resistance (phase-to-phase)	[Ω]	11.7	11.7	4.85	4.85	2.68	2.68
Winding inductance (phase-to-phase)	[mH]	38	38	20	20	12	12
Winding series inductance Ld (phase)	[mH]	15.5	15.5	8	8	5	5
Winding shunt inductance Lq (phase)	[mH]	19	19	10	10	6	6
Total output moment of inertia ²⁾	[kgcm ²]	0.169/0.257	0.169/0.257	0.286/0.373	0.286/0.373	0.403/0.490	0.403/0.490
Shaft load at nominal rotational speed							
Radial	[N]	350					
Axial	[N]	65					
Brake							
Operating voltage	[V DC]	24 (+6 ... -10%)					
Current consumption	[A]	0.46					
Power	[W]	11					
Holding torque (static)	[Nm]	2.5					
Separation time	[ms]	≤ 35					
Closing time	[ms]	10					
Response delay	[ms]	≤ 2					
Coil resistance	[Ω]	52.4					
Coil inductance	[mH]	700					
Mass moment of inertia	[kgcm ²]	0.074					
Max. friction per braking process	[J]	5600					
Total friction	[kJ]	615					

1) With 3-phase mains supply to the servo drive, a voltage up to 3x 480 V AC +10% is permitted
 2) Without brake/with brake
 3) When using the radial shaft seal, a reduction (derating) of the nominal torque of 10% must be taken into account
 For motors with safety encoders, a derating must be taken into account in line with the specification in the datasheet when using the radial shaft seal.
 4) Inner stall torque constant

Datasheet

Technical data									
Flange size		80							
Length		S		M		L		H	
Winding		LS	HS	LS	HS	LS	HS	HS	
Nominal operating voltage ¹⁾	[V DC]	325	680	325	680	325	680	680	
Nominal current	[A]	2.7	1.76	4.1	2.2	5.5	3.5	3.8	
Continuous stall current	[A]	3.1	2	4.9	2.6	6.7	4.3	4.8	
Peak current	[A]	8.4	5.4	17.1	9	27.3	17.5	21.7	
Nominal power	[W]	408	408	690	690	910	910	1070	
Nominal torque ³⁾	[Nm]	1.3	1.3	2.2	2.2	2.9	2.9	3.4	
Peak torque	[Nm]	2.8	2.8	6.4	6.4	9.9	9.9	13.5	
Stall torque	[Nm]	1.46	1.46	2.6	2.6	3.5	3.5	4.3	
Stall torque constant ⁴⁾	[Nm/A]	0.57	0.89	0.62	1.17	0.6	0.93	1	
Nominal rotational speed	[rpm]	3000							
Max. rotational speed	[rpm]	6700	8950	6150	6800	6400	8540	7820	
Max. mechanical rotational speed	[rpm]	14000							
Max. idling rotational speed with brake	[rpm]	10000							
Angular acceleration	[rad/s ²]	≤ 100000							
Motor constant	[Nm/A]	0.48	0.74	0.54	1	0.53	0.82	0.9	
Voltage constant (phase-to-phase)	[mVmin]	34.3	53.6	37.3	70.7	36	56	61.4	
Electric time constant	[ms]	4.9	4.8	6.5	6.4	6.9	7	7.2	
Thermal time constant	[min]	42	42	45	45	48	48	51	
Thermal resistance	[K/W]	0.95	0.95	0.78	0.78	0.68	0.68	0.65	
Number of pole pairs		5	5	5	5	5	5	5	
Winding resistance (phase-to-phase)	[Ω]	4.93	12.4	2.04	7.43	1.13	2.69	2.21	
Winding inductance (phase-to-phase)	[mH]	16.3	39.8	8.9	31.8	5.2	12.6	10.7	
Winding series inductance Ld (phase)	[mH]	10.2	25	5.4	19.4	3.1	7.5	6.6	
Winding shunt inductance Lq (phase)	[mH]	12.2	29.8	6.6	23.8	3.9	9.45	8.0	
Total output moment of inertia ²⁾	[kgcm ²]	0.59/0.89	0.59/0.89	1.04/1.28	1.04/1.28	1.47/1.99	1.47/1.99	1.91/2.42	
Shaft load at nominal rotational speed									
Radial	[N]	620							
Axial	[N]	120							
Brake									
Operating voltage	[V DC]	24 (+6 ... -10%)							
Current consumption	[A]	0.5	0.5	0.5	0.5	0.63	0.63	0.63	
Power	[W]	12	12	12	12	15	15	15	
Holding torque (static)	[Nm]	4.5	4.5	4.5	4.5	7	7	7	
Separation time	[ms]	≤ 55	≤ 55	≤ 55	≤ 55	≤ 45	≤ 45	≤ 45	
Closing time	[ms]	≤ 15	≤ 15	≤ 15	≤ 15	≤ 30	≤ 30	≤ 30	
Response delay	[ms]	≤ 3	≤ 3	≤ 3	≤ 3	≤ 4	≤ 4	≤ 4	
Coil resistance	[Ω]	48	48	48	48	38.4	38.4	38.4	
Coil inductance	[mH]	1000	1000	1000	1000	900	900	900	
Mass moment of inertia	[kgcm ²]	0.249	0.249	0.249	0.249	0.459	0.459	0.459	
Max. friction per braking process	[J]	8200	8200	8200	8200	12000	12000	12000	
Total friction	[kJ]	580				2400			

1) With 3-phase mains supply to the servo drive, a voltage up to 3x 480 V AC +10% is permitted

2) Without brake/with brake

3) When using the radial shaft seal, a reduction (derating) of the nominal torque of 10% must be taken into account

For motors with safety encoders, a derating must be taken into account in line with the specification in the datasheet when using the radial shaft seal.

4) Inner stall torque constant

Datasheet

Technical data					
Flange size		100			
Length		S	M	L	H
Winding		HS	HS	HS	HS
Nominal operating voltage ¹⁾	[V DC]	680	680	680	680
Nominal current ²⁾	[A]	3.5	4.3	4.7/4.3	5.9/5.5
Continuous stall current ²⁾	[A]	4.4	5.9	7/6.7	9.7/9.5
Peak current	[A]	13.7	22.1	28.6	36
Nominal power ²⁾	[W]	1450	1770	2030/1870	2200/2060
Nominal torque ²⁾³⁾	[Nm]	5.1	6.3	7.2/6.6	7.8/7.3
Peak torque	[Nm]	13.7	22.4	30.5	38.7
Stall torque ²⁾	[Nm]	6.3	8.6	10.8/10.4	13/12.4
Stall torque constant ⁴⁾	[Nm/A]	1.67	1.66	1.75	1.54
Nominal rotational speed	[rpm]	2700			
Max. rotational speed	[rpm]	4770	4790	4530	5150
Max. mechanical rotational speed	[rpm]	13000			
Max. idling rotational speed with brake	[rpm]	10000			
Angular acceleration	[rad/s ²]	≤ 100000			
Motor constant	[Nm/A]	1.45	1.46	1.54	1.32
Voltage constant (phase-to-phase)	[mVmin]	101	100	106	93.2
Electric time constant	[ms]	14.5	16.6	15.8	16.7
Thermal time constant	[min]	74	73	71	68
Thermal resistance	[K/W]	0.6	0.5	0.46	0.39
Number of pole pairs		5	5	5	5
Winding resistance (phase-to-phase)	[Ω]	3.35	1.84	1.49	0.81
Winding inductance (phase-to-phase)	[mH]	32.4	20.4	15.7	9
Winding series inductance Ld (phase)	[mH]	17.8	10.2	8.7	5.7
Winding shunt inductance Lq (phase)	[mH]	24.3	15.3	11.8	6.8
Total output moment of inertia ²⁾	[kgcm ²]	3.15/4.04	4.46/5.34	5.77/8.06	8.80/11.09
Shaft load at nominal rotational speed					
Radial	[N]	1110			815
Axial	[N]	200			
Brake					
Operating voltage	[V DC]	24 (+6 ... -10%)			
Current consumption	[A]	0.75	0.75	1	
Power	[W]	18	18	24	
Holding torque (static)	[Nm]	11	11	18	
Separation time	[ms]	≤ 80			
Closing time	[ms]	≤ 20	≤ 20	≤ 40	
Response delay	[ms]	≤ 4	≤ 4	≤ 5	
Coil resistance	[Ω]	32	32	24	
Coil inductance	[mH]	900	900	900	
Mass moment of inertia	[kgcm ²]	0.74	0.74	2.15	
Max. friction per braking process	[J]	12000	12000	15000	
Total friction	[kJ]	1335		3600	

- 1) With 3-phase mains supply to the servo drive, a voltage up to 3x 480 V AC +10% is permitted
- 2) Without brake/with brake
- 3) When using the radial shaft seal, a reduction (derating) of the nominal torque of 10% must be taken into account
For motors with safety encoders, a derating must be taken into account in line with the specification in the datasheet when using the radial shaft seal.
- 4) Inner stall torque constant

Datasheet

Technical data					
Flange size		150			
Length		M		L	
Winding		HS	HV	HT	HS
Nominal operating voltage ¹⁾	[V DC]	680	680	680	680
Nominal current	[A]	9.5	10.2	10.3	15.4
Continuous stall current	[A]	11.4	24	11.4	23.6
Peak current	[A]	24	50	24	49.5
Nominal power	[W]	4257	4948	4157	6377
Nominal torque ³⁾	[Nm]	27.1	13.5	39.7	29
Peak torque	[Nm]	64	60	86	87
Stall torque	[Nm]	33	33	44	45.5
Stall torque constant ⁴⁾	[Nm/A]	3.3	1.54	4.38	2.23
Nominal rotational speed	[rpm]	1500	3500	1000	2100
Max. rotational speed	[rpm]	2368	5051	1812	3495
Max. mechanical rotational speed	[rpm]	10000			
Angular acceleration	[rad/s ²]	≤ 100000			
Motor constant	[Nm/A]	2.85	1.32	3.85	1.88
Voltage constant (phase-to-phase)	[mVmin]	199.4	92.9	264.9	135.1
Electric time constant	[ms]	15.4	15.6	15.6	17.1
Thermal time constant	[min]	45	45	55	55
Thermal resistance	[K/W]	0.45	0.46	0.42	0.39
Number of pole pairs		5	5	5	5
Winding resistance (phase-to-phase)	[Ω]	0.935	0.211	1.016	0.250
Winding inductance (phase-to-phase)	[mH]	14.6	3.3	15.7	4.4
Winding series inductance L _d (phase)	[mH]	7.2	1.65	7.95	2.15
Winding shunt inductance L _q (phase)	[mH]	7.3	1.65	7.85	2.2
Total output moment of inertia ²⁾	[kgcm ²]	38.7/46.9		57.6/70.1	
Shaft load at nominal rotational speed					
Radial	[N]	1470	1085	1730	1370
Axial	[N]	294	217	346	274
Brake					
Operating voltage	[V DC]	24			
Current consumption	[A]	1.08			
Power	[W]	26			
Holding torque (static)	[Nm]	45	65		
Separation time	[ms]	230	200		
Closing time	[ms]	45	40		
Response delay	[ms]	≤ 6	≤ 10		
Mass moment of inertia	[kgcm ²]	8.2	12.5		
Max. friction per braking process	[J]	28000	40000		
Total friction	[kJ]	2600	4500		

1) With 3-phase mains supply to the servo drive, a voltage up to 3x 480 V AC +10% is permitted

2) Without brake/with brake

3) When using the radial shaft seal, a reduction (derating) of the nominal torque of 10% must be taken into account

4) Inner stall torque constant

Datasheet

Technical data			
Flange size		190	
Length		M	L
Winding		HS	HT
Nominal operating voltage ¹⁾	[V DC]	680	680
Nominal current	[A]	19.2	20
Continuous stall current	[A]	25	22.8
Peak current	[A]	41.5	49.7
Nominal power	[W]	7427	8629
Nominal torque ³⁾	[Nm]	59.1	82.4
Peak torque	[Nm]	118.3	183.3
Stall torque	[Nm]	76.7	93.7
Stall torque constant ⁴⁾	[Nm/A]	3.56	4.79
Nominal rotational speed	[rpm]	1200	1000
Max. rotational speed	[rpm]	2163	1654
Max. mechanical rotational speed	[rpm]	8000	
Angular acceleration	[rad/s ²]	≤ 100000	
Motor constant	[Nm/A]	3.08	4.12
Voltage constant (phase-to-phase)	[mVmin]	215.2	289.7
Electric time constant	[ms]	39.6	38.8
Thermal time constant	[min]	70	80
Thermal resistance	[K/W]	0.31	0.30
Number of pole pairs		5	5
Winding resistance (phase-to-phase)	[Ω]	0.285	0.358
Winding inductance (phase-to-phase)	[mH]	12.3	13.8
Winding series inductance Ld (phase)	[mH]	5.65	6.95
Winding shunt inductance Lq (phase)	[mH]	6.15	6.9
Total output moment of inertia ²⁾	[kgcm ²]	110/160	145/195
Shaft load at nominal rotational speed			
Radial	[N]	2420	2620
Axial	[N]	480	520
Brake			
Operating voltage	[V DC]	24	
Current consumption	[A]	2.08	
Power	[W]	50	
Holding torque (static)	[Nm]	115	
Separation time	[ms]	190	
Closing time	[ms]	65	
Response delay	[ms]	≤ 12	
Mass moment of inertia	[kgcm ²]	50	
Max. friction per braking process	[J]	62000	
Total friction	[kJ]	13000	

1) With 3-phase mains supply to the servo drive, a voltage up to 3x 480 V AC +10% is permitted

2) Without brake/with brake

3) When using the radial shaft seal, a reduction (derating) of the nominal torque of 10% must be taken into account

4) Inner stall torque constant

Datasheet

Weight [kg]											
Flange size	60			80				100			
Length	S	M	L	S	M	L	H	S	M	L	H
Without brake	1.18	1.53	1.91	2.02	2.64	3.29	3.91	5.5	7.1	8.7	11.9
With brake	1.50	1.85	2.23	2.72	3.36	4.12	4.75	6.7	8.2	10.1	13.3

Weight [kg]						
Flange size	150		190			
Length	M		L	M		L
Without brake	18.7		25.4	42.2		53
With brake	22.2		29.7	50.6		61.5

Operating and environmental conditions											
Flange size	60			80				100			
Length	S	M	L	S	M	L	H	S	M	L	H
Standard	IEC 60034										
Motor type to EN 60034-7	IM B5/IM V1/IM V3										
Degree of protection											
Motor shaft	IP40										
With rotary shaft seal	IP65										
Motor housing incl. connection technology	IP67										
Ambient temperature											
Temperature	[°C] -15 ... +40										
Up to 80 °C with derating of ... per degree Celsius ¹⁾	[%] -1.5 -1.5 -1.5 -1.5 -1.5 -1.5 -1.5 -1.5 -1.5 -1.5 -1.75/-2.25										
Storage temperature	[°C] -20 ... +70										
Max. winding temperature	[°C] 155										
Temperature monitoring	Digital motor temperature transmission via EnDat 2.2										
Rating class to EN 60034-1	S1										
Thermal class to EN 60034-1	F										
Relative humidity	[%] 0 ... 90 (non-condensing)										
Concentricity to DIN SPEC 42955	N										
Balance quality	G 2.5										
Pollution degree	2										
Max. setup altitude	[m] 4000 (at 1000 m or higher only with derating of -1.0% per 100 m)										
Bearing lifetime under nominal conditions	[h] 20000										
Switching cycles of holding brake ¹⁾	10 million idle actuations										
CE marking (see declaration of conformity)	To EU Low Voltage Directive To EU EMC Directive ²⁾ To EU RoHS Directive										
UKCA marking (see declaration of conformity)	To UK regulations for electrical equipment To UK EMC regulations To UK RoHS regulations										
Certification	c UL us - Recognized (OL) RCM Mark										
Certificate-issuing authority	UL E342973 TÜV 968/INS 464.00/24 ³⁾										
Energy efficiency	ENEFF (CN) / Class 2										
Vibration resistant	To EN 60068-2-6										
Shock resistance	To EN 60068-2-27										
LABS (PWIS) conformity	VDMA24364 zone III										
Note on materials	RoHS-compliant										

1) Without friction

Without brake/with brake

2) For information about the area of use, see the EC declaration of conformity at: www.festo.com/sp → Certificates.

If the devices are subject to usage restrictions in residential, commercial or light-industrial environments, further measures for the reduction of the emitted interference may be necessary.

3) Only variant with absolute safety encoder, multi-turn

Datasheet

Operating and environmental conditions				
Flange size	150		190	
Length	M	L	M	L
Standard	IEC 60034			
Motor type to EN 60034-7	IM B5/IM V1/IM V3			
Degree of protection				
Motor shaft	IP21			
With rotary shaft seal	IP65			
Motor housing incl. connection technology	IP67			
Ambient temperature				
Temperature	[°C]	-15 ... +40		
Up to 80 °C with derating of ... per degree Celsius ¹⁾	[%]	-1.5	-1.5	-1.5
Storage temperature	[°C]	-20 ... +70		
Max. winding temperature	[°C]	155		
Temperature monitoring	Digital motor temperature transmission via EnDat 2.2			
Rating class to EN 60034-1	S1			
Thermal class to EN 60034-1	F			
Relative humidity	[%]	0 ... 90 (non-condensing)		
Concentricity to DIN SPEC 42955	N			
Balance quality	G 2.5			
Pollution degree	2			
Max. setup altitude	[m]	4000 (at 1000 m or higher only with derating of -1.0% per 100 m)		
Bearing lifetime under nominal conditions	[h]	20000		
Switching cycles of holding brake ¹⁾	5 million idle actuations			
CE marking (see declaration of conformity)	To EU Low Voltage Directive			
	To EU EMC Directive ²⁾			
	To EU RoHS Directive			
UKCA marking (see declaration of conformity)	To UK regulations for electrical equipment			
	To UK EMC regulations			
	To UK RoHS regulations			
Certification	cUL us - Recognized (OL)			
	RCM Mark			
Certificate-issuing authority	UL E342973			
	TÜV 968/FSP 2317.00/21 ³⁾			
Energy efficiency	ENEFF (CN) / Class 1			
Vibration resistant	To EN 60068-2-6			
Shock resistance	To EN 60068-2-27 (15g/11ms)			
Continuous shock resistance	To EN 60068-2-29			
LABS (PWIS) conformity	VDMA24364 zone III			
Note on materials	RoHS-compliant			

1) Without friction work

2) For information about the area of use, see the EC declaration of conformity at: www.festo.com/sp → Certificates.

If the devices are subject to usage restrictions in residential, commercial or light-industrial environments, further measures for the reduction of the emitted interference may be necessary.

3) Only variant with absolute safety encoder, multi-turn

Datasheet

Technical data – Encoder					
Measuring unit		Absolute encoder, single-turn		Absolute encoder, multi-turn	
Rotor position encoder, operating voltage	[V DC]	5			
Rotor position encoder, operating voltage range	[V DC]	3.6 ... 14			
Protocol		EnDat 2.2, digital channel only, max. switching frequency (CLOCK) ≤ 16 MHz			
Rotor position sensor measuring principle		Inductive			
Position values per revolution					
Flange size 60; 80		262144		524288	
Flange size 100; 150; 190		524288		524288	
Rotor position encoder resolution					
Flange size 60; 80		18 bits		19 bits	
Flange size 100; 150; 190		19 bits		19 bits	
Absolute detectable revolutions		1		4096 (12 bit)	
Rotor position encoder, system accuracy of angle measurement					
Flange size 60		[arcsec]	-120 ... 120		
Flange size 80		[arcsec]	-120 ... 120		
Flange size 100; 150; 190		[arcsec]	-65 ... 65		

Technical data – Safety encoder				
Measuring unit		Absolute safety encoder, multi-turn, EnDat		
Flange size		60, 80	100	150, 190
Rotor position encoder, operating voltage	[V DC]	5		
Rotor position encoder, operating voltage range	[V DC]	3.6 ... 14		
Rotary position encoder interface		EnDat 2.2		
Rotor position sensor measuring principle		Inductive		
Position values per revolution		524288		
Rotor position encoder resolution		19 bits		
Absolute detectable revolutions		4096 (12 bit)		
Rotor position encoder, system accuracy of angle measurement	[arcsec]	-120 ... 120	-65 ... 65	

Safety data – Safety encoder				
Measuring unit		Absolute safety encoder, multi-turn		
Flange size		60, 80	100	150, 190
Maximum SIL		SIL 3		SIL 2
Maximum performance level and category		Performance Level e, Category 3		Performance Level d, Category 3
Safety sub-function up to SIL 2		Reliable acquisition and transmission of single-turn position data		
Safety sub-function up to SIL 3		Reliable acquisition and transmission of single-turn position data, only with additional software function in the servo drive		–
Safety sub-function up to Performance Level d, Category 3		Reliable acquisition and transmission of single-turn position data		
Safety sub-function up to Performance Level e, Category 3		Reliable acquisition and transmission of single-turn position data, only with additional software function in the servo drive		–
PFH _D , subcomponent	[1/h]	15 x 10 ⁻⁹ , encoder		
Service life		20 years, rotor position sensor		

Datasheet

Pin allocation – Motor side

M23x1, pins, 15-pin

	PIN	Function
	1	BR- Brake
	2	-
	3	-
	4	BR+ Brake
	5	Up Encoder power supply
	6	0 V Encoder power supply
	7	Data + Encoder communication
	8	Data - Encoder communication
	9	CLK + Encoder communication
	10	CLK - Encoder communication
	A	U Motor power supply
	B	V Motor power supply
	C	W Motor power supply
	D	-
	PE	PE Protective earth conductor

M40x1, pins, 15-pin

	PIN	Function
	1	BR- Brake
	2	-
	3	-
	4	BR+ Brake
	5	Up Encoder power supply
	6	0 V Encoder power supply
	7	Data + Encoder communication
	8	Data - Encoder communication
	9	CLK + Encoder communication
	10	CLK - Encoder communication
	A	U Motor power supply
	B	V Motor power supply
	C	W Motor power supply
	D	-
	PE	PE Protective earth conductor

Datasheet

Torque M as a function of rotational speed n

Flange size 60

Length S

Winding LS (without brake)

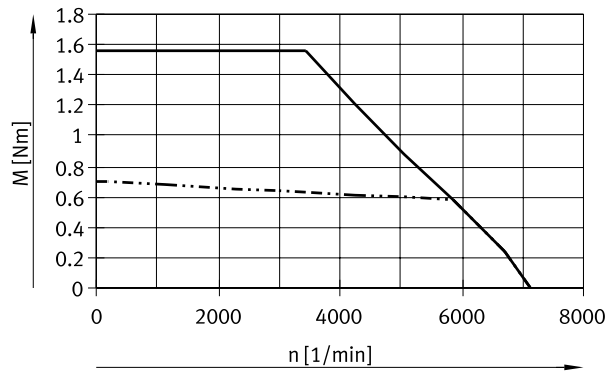

- Peak torque at 325 V DC
- · · · · · Nominal torque

Winding LS-B (with brake)

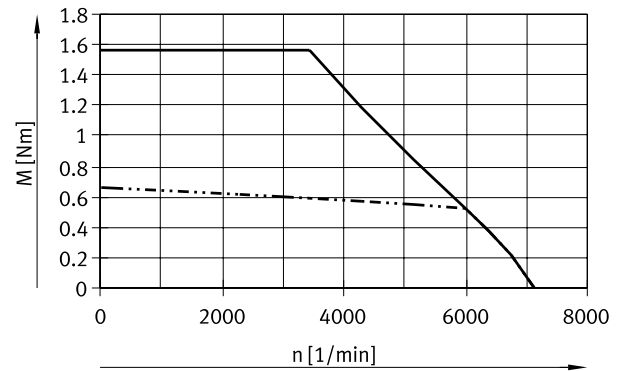

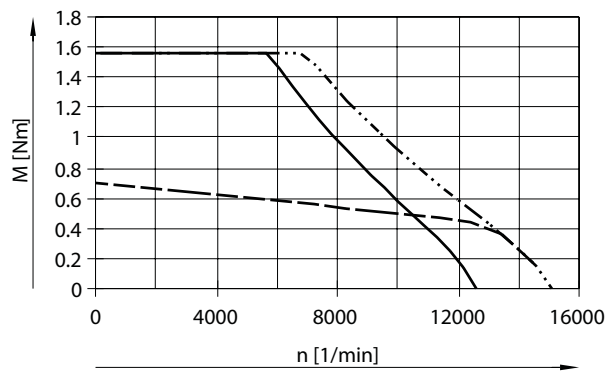

Winding HS (without brake)

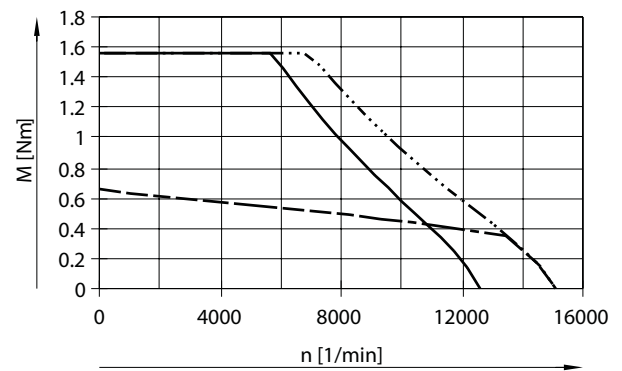

- Peak torque at 565 V DC
- · · · · · Peak torque at 680 V DC
- - - - - Nominal torque

Winding HS-B (with brake)



 Note

Typical motor characteristic curve with nominal voltage and optimal motor controller.
Observe the maximum permissible rotational speeds of add-on and installation components (such as brake, encoder, etc.).

Datasheet

Torque M as a function of rotational speed n

Flange size 60

Length M

Winding LS (without brake)

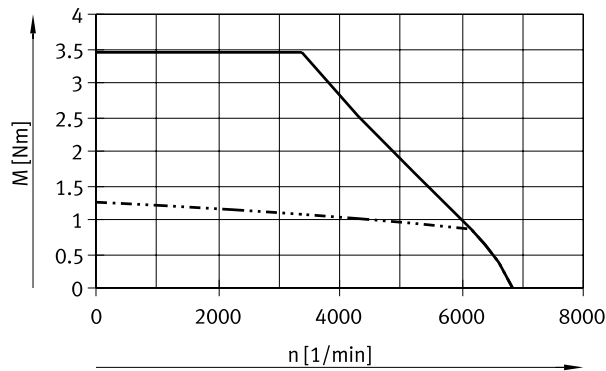

Winding LS-B (with brake)

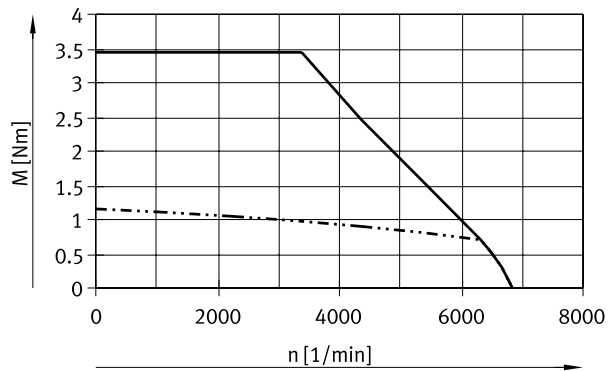

- Peak torque at 325 V DC
- · · · · · Nominal torque

Winding HS (without brake)

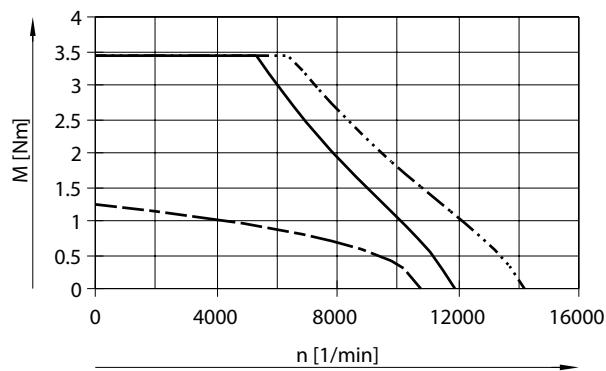

Winding HS-B (with brake)

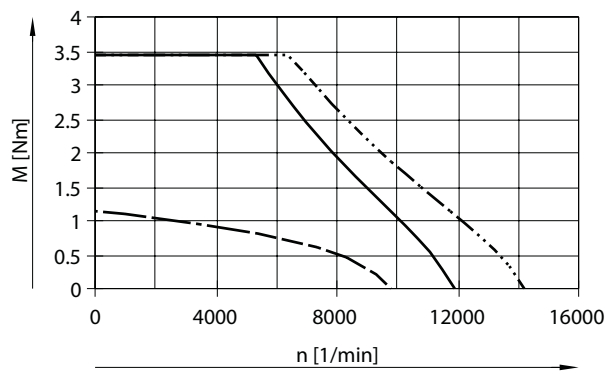

- Peak torque at 565 V DC
- · · · · · Peak torque at 680 V DC
- - - - - Nominal torque

Note

Typical motor characteristic curve with nominal voltage and optimal motor controller.
Observe the maximum permissible rotational speeds of add-on and installation components (such as brake, encoder, etc.).

Datasheet

Torque M as a function of rotational speed n

Flange size 60

Length L

Winding LS (without brake)

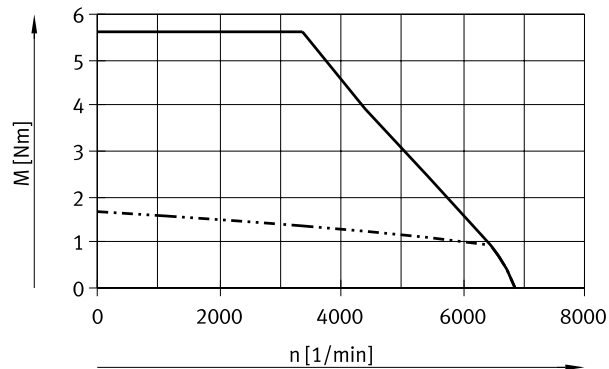

— Peak torque at 325 V DC
 - · - · - · - Nominal torque

Winding LS-B (with brake)

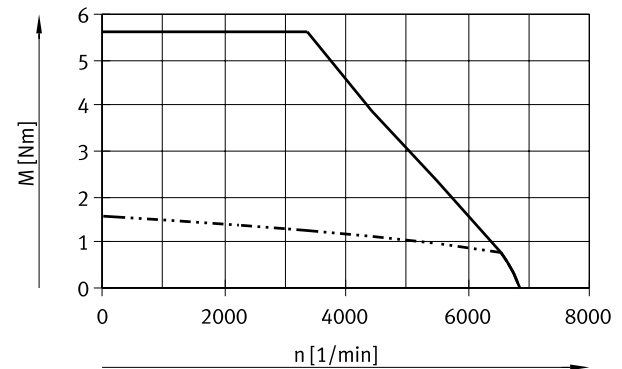

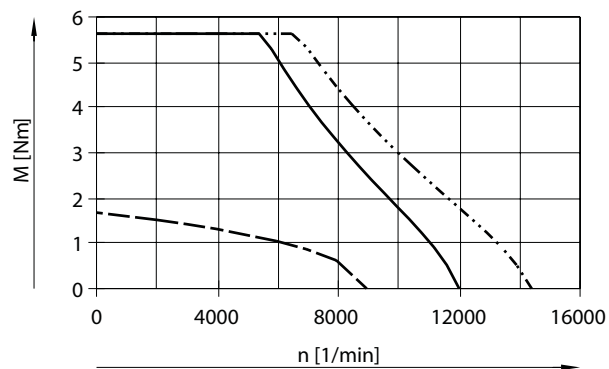

Winding HS (without brake)

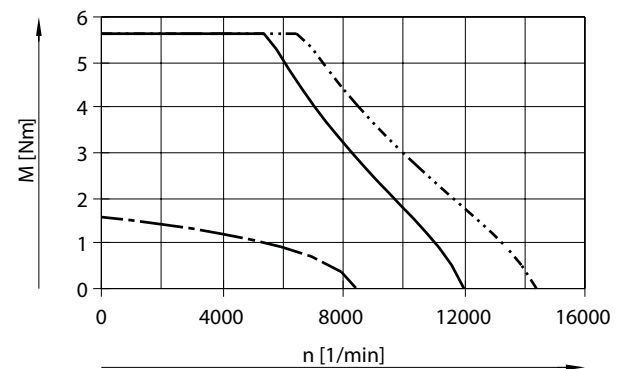

— Peak torque at 565 V DC
 - · - · - · - Peak torque at 680 V DC
 - - - - - Nominal torque

Winding HS-B (with brake)



 **Note**

Typical motor characteristic curve with nominal voltage and optimal motor controller.

Observe the maximum permissible rotational speeds of add-on and installation components (such as brake, encoder, etc.).

Datasheet

Torque M as a function of rotational speed n

Flange size 80

Length S

Winding LS (without/with brake)

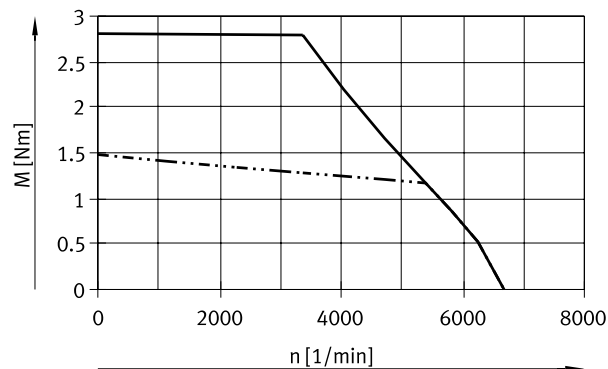

— Peak torque at 325 V DC
 - · - · - Nominal torque

Winding HS (without/with brake)

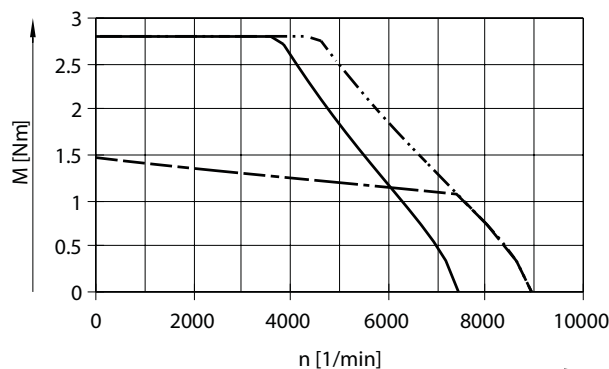

— Peak torque at 565 V DC
 - · - · - Peak torque at 680 V DC
 - - - - Nominal torque

Length M

Winding LS (without/with brake)

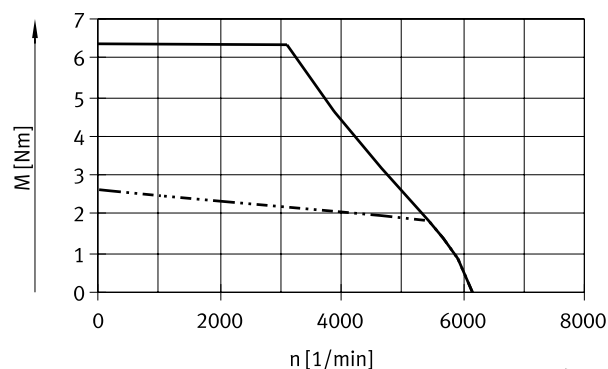

— Peak torque at 325 V DC
 - · - · - Nominal torque

Winding HS (without/with brake)

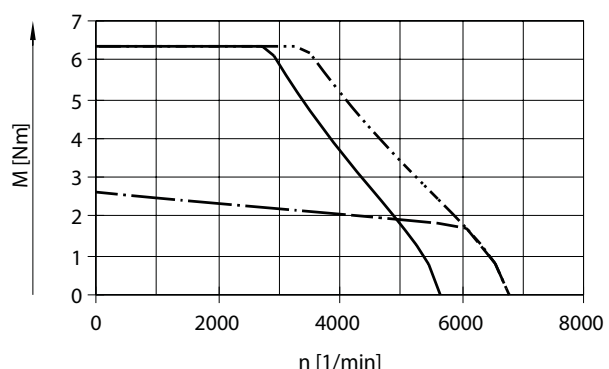

— Peak torque at 565 V DC
 - · - · - Peak torque at 680 V DC
 - - - - Nominal torque

Note

Typical motor characteristic curve with nominal voltage and optimal motor controller.
 Observe the maximum permissible rotational speeds of add-on and installation components (such as brake, encoder, etc.).

Datasheet

Torque M as a function of rotational speed n

Flange size 80

Length L

Winding LS (without/with brake)

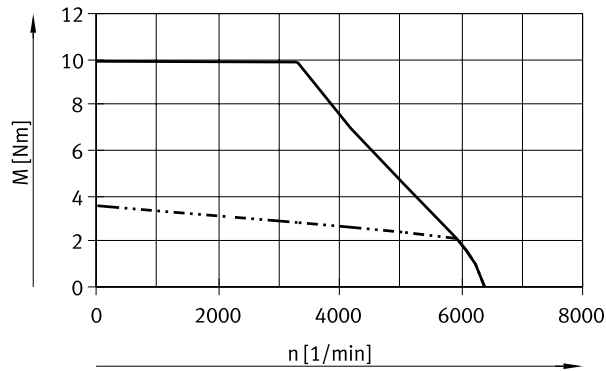

- Peak torque at 325 V DC
- · - · - Nominal torque

Winding HS (without/with brake)

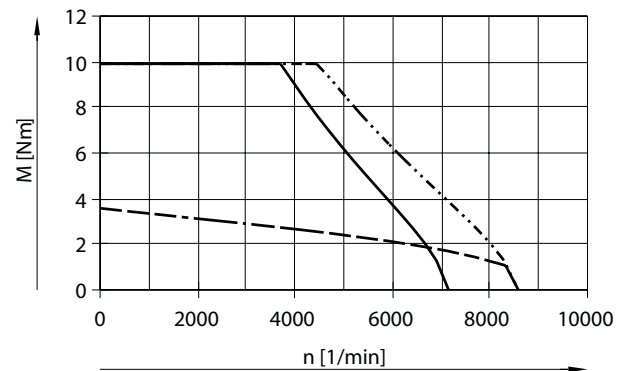

- Peak torque at 565 V DC
- · - · - Peak torque at 680 V DC
- - - Nominal torque

Length H

Winding HS (without/with brake)

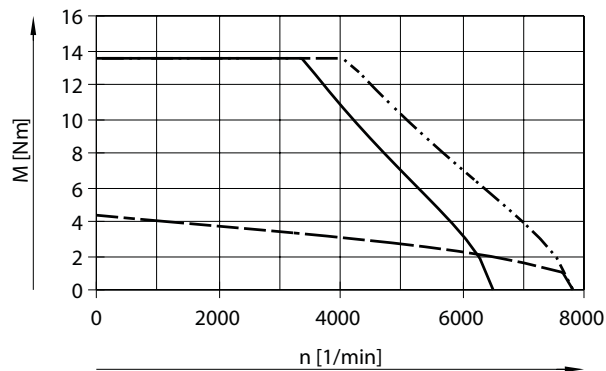

- Peak torque at 565 V DC
- · - · - Peak torque at 680 V DC
- - - Nominal torque

Note

Typical motor characteristic curve with nominal voltage and optimal motor controller.
Observe the maximum permissible rotational speeds of add-on and installation components (such as brake, encoder, etc.).

Datasheet

Torque M as a function of rotational speed n

Flange size 100

Length S

Winding HS (without/with brake)

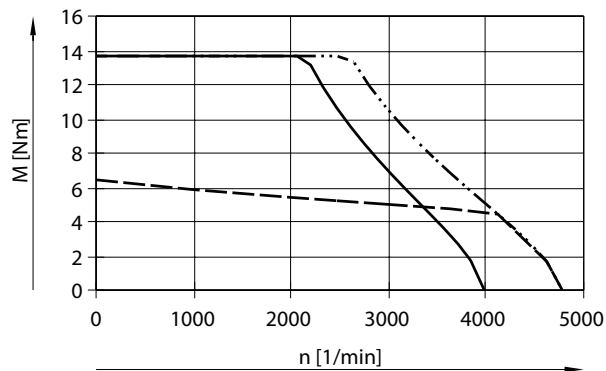

- Peak torque at 565 V DC
- Peak torque at 680 V DC
- - - Nominal torque

Length M

Winding HS (without/with brake)

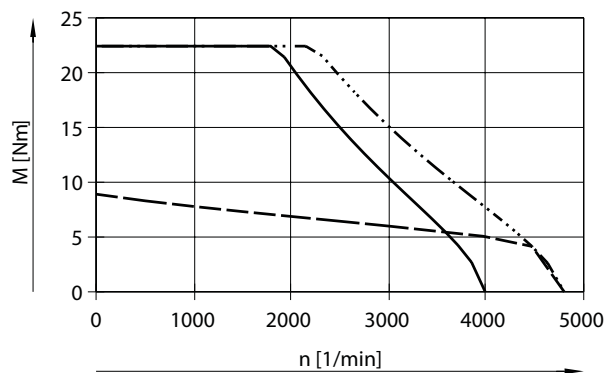

- Peak torque at 565 V DC
- Peak torque at 680 V DC
- - - Nominal torque

Note

Typical motor characteristic curve with nominal voltage and optimal motor controller.
Observe the maximum permissible rotational speeds of add-on and installation components (such as brake, encoder, etc.).

Datasheet

Torque M as a function of rotational speed n

Flange size 100

Length L

Winding HS (without brake)

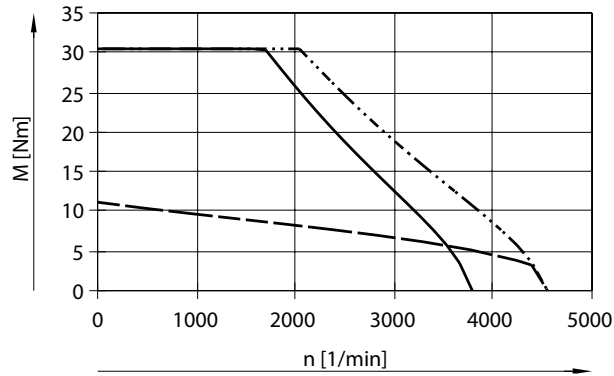

Winding HS-B (with brake)

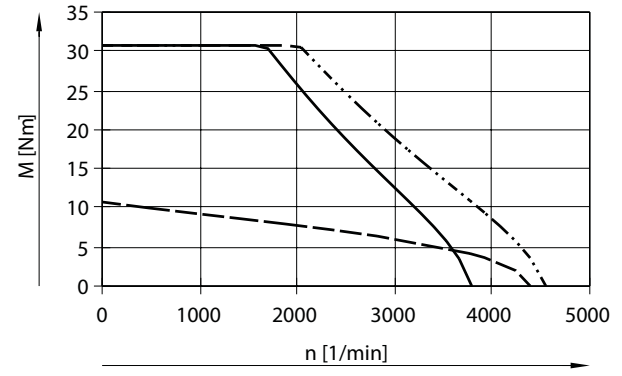

- Peak torque at 565 V DC
- ⋯ Peak torque at 680 V DC
- - - Nominal torque

Length H

Winding HS (without brake)

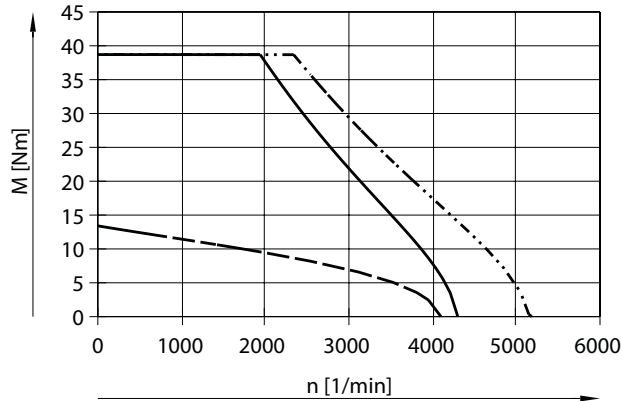

Winding HS-B (with brake)

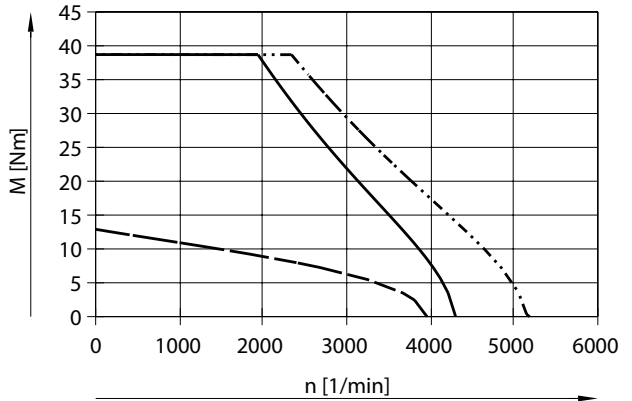

- Peak torque at 565 V DC
- ⋯ Peak torque at 680 V DC
- - - Nominal torque

Note

Typical motor characteristic curve with nominal voltage and optimal motor controller.
Observe the maximum permissible rotational speeds of add-on and installation components (such as brake, encoder, etc.).

Datasheet

Torque M as a function of rotational speed n

Flange size 150

Length M

Winding HS (without/with brake)

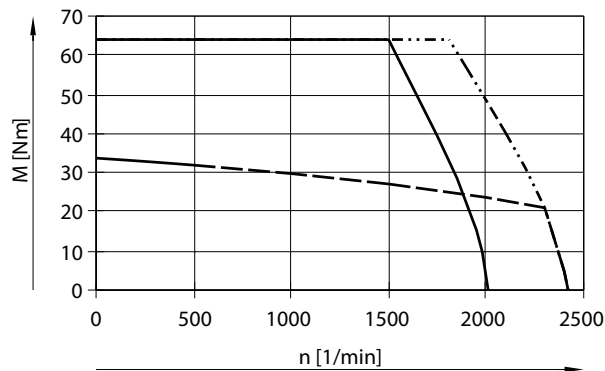

- Peak torque at 565 V DC
- ⋯ Peak torque at 680 V DC
- - - Nominal torque

Winding HV (without/with brake)

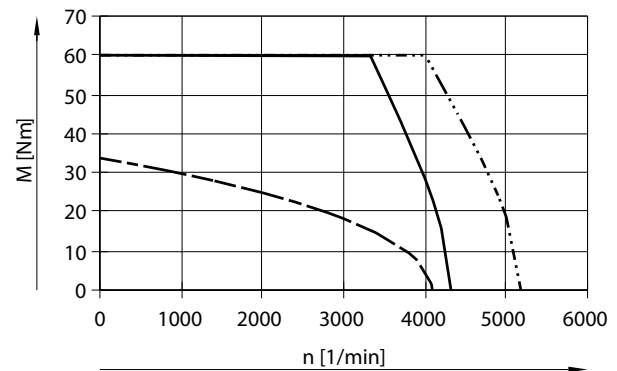

Length L

Winding HS (without/with brake)

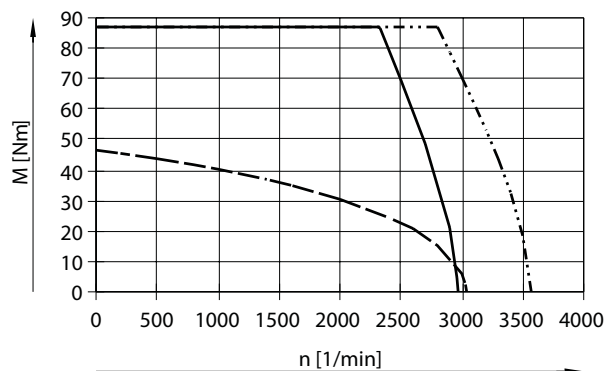

- Peak torque at 565 V DC
- ⋯ Peak torque at 680 V DC
- - - Nominal torque

Winding HT (without/with brake)

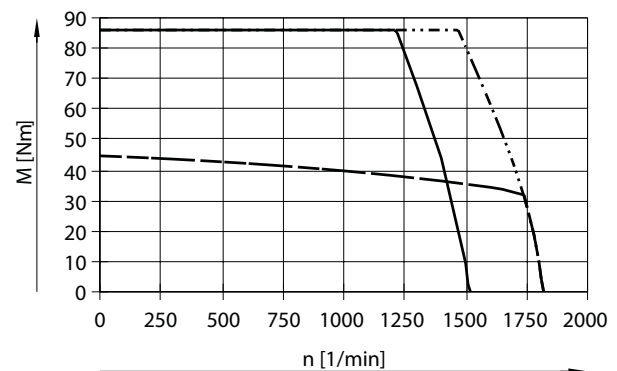

Note

Typical motor characteristic curve with nominal voltage and optimal motor controller.
Observe the maximum permissible rotational speeds of add-on and installation components (such as brake, encoder, etc.).

Datasheet

Torque M as a function of rotational speed n

Flange size 190

Length M

Winding HS (without/with brake)

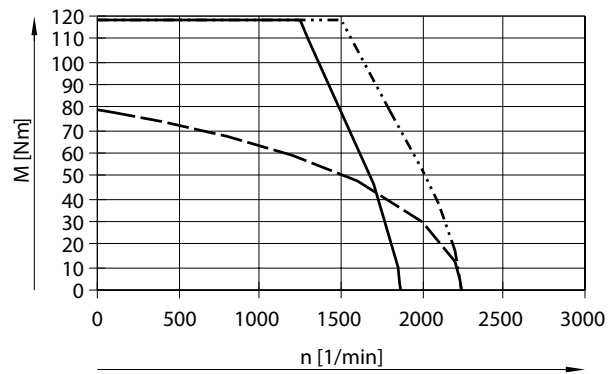

- Peak torque at 565 V DC
- ⋯ Peak torque at 680 V DC
- - - Nominal torque

Length L

Winding HT (without/with brake)

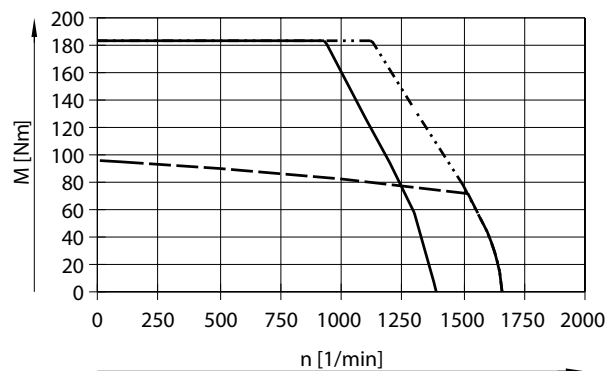

- Peak torque at 565 V DC
- ⋯ Peak torque at 680 V DC
- - - Nominal torque

**Note**

Typical motor characteristic curve with nominal voltage and optimal motor controller.

Observe the maximum permissible rotational speeds of add-on and installation components (such as brake, encoder, etc.).

Datasheet

Dimensions – Flange size 60, 80, 100

Download CAD data → www.festo.com

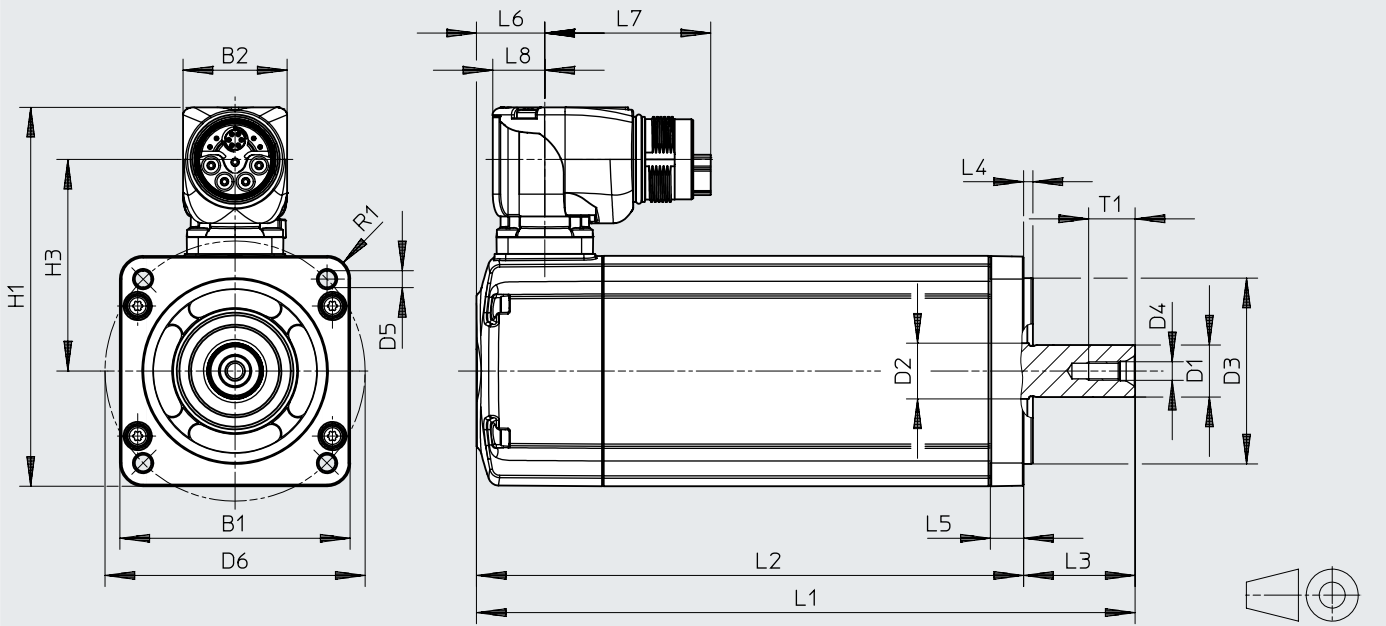

Note
 Only motors without feather key may be used in combination with parallel and axial kits (EAMM-U/EAMM-A).

	Length	Interface code, motor	B1	B2	D1 ø h6	D2 ø	D3 ø h7	D4	D5 ø
60	S	60P	62	28	14	15	50	M5	4.3
	M								
	L								
80	S	80P	82	28	19	20	70	M6	5.3
	M								
	L								
	H								
100	S	100A	104	28	19	20	95	M6	9
	M								
	L								
	H								

	Length	D6 ø ±0.3	H1	H3	L1		L2		L3
						With brake	±2	With brake ±2	
60	S	70	102	57	144.5	177.3	114.5	147.3	30+0.5/-0.2
	M				164.5	197.3	134.5	167.3	
	L				184.5	217.3	154.5	187.3	
80	S	90	122	67	165.2	209.4	130.2	174.4	35+0.4/-0.2
	M				185.2	229.4	150.2	194.4	
	L				205.2	249.4	170.2	214.4	
	H				225.2	269.4	190.2	234.4	
100	S	115	144	78	227.5	271.7	187.5	231.7	40+0.4/-0.2
	M				257.5	301.7	217.5	261.7	
	L				287.5	330.7	247.5	290.7	
	H				344.5	388.7	304.5	348.7	

Datasheet

	Length	L4	L5	L6	L7	L8	R1	T1
		±0.2	±0.3					
60	S	2.5	9	18.4	44.7	14	6	12.5
	M							
	L							
80	S	3	10	20.1	44.7	14	8	16
	M							
	L							
	H							
100	S	3	12	22.7	44.7	14	11	16
	M							
	L							
	H							

Dimensions – Feather key for flange size 60, 80, 100

Download CAD data → www.festo.com

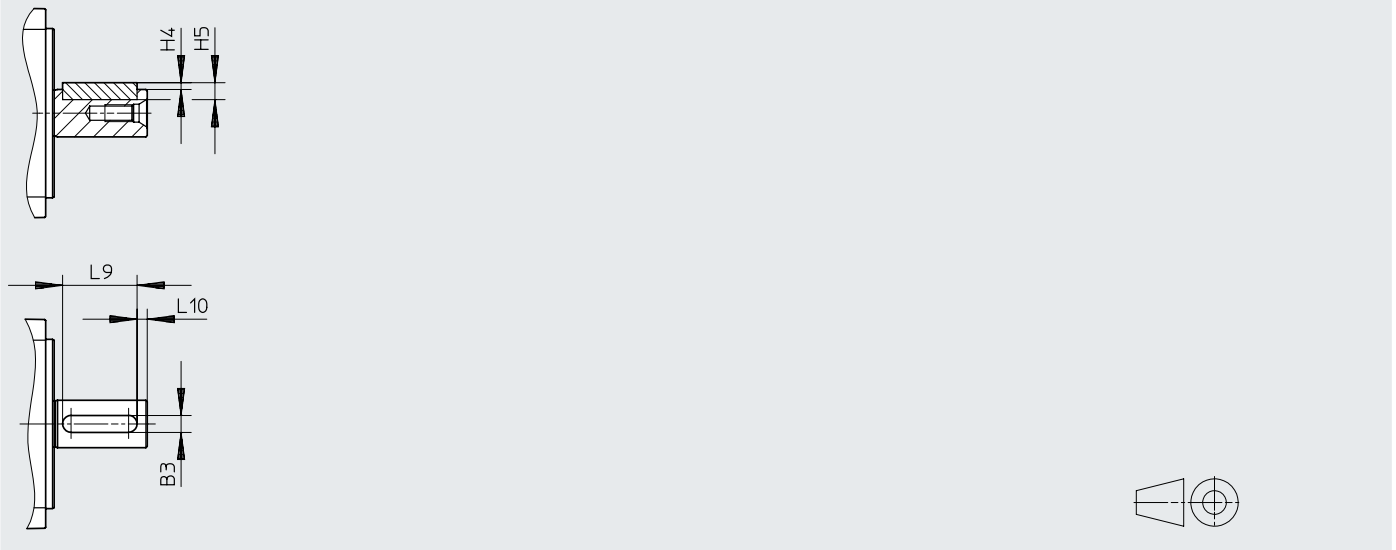

	B3	H4	H5	L9	L10	Feather key
EMMT-AS-60-...-K	5	2	5	22	3	DIN 6885 A 5x5x22
EMMT-AS-80-...-K	6	2.5	6	22	3	DIN 6885 A 6x6x22
EMMT-AS-100-...-K	6	2.5	6	32	3	DIN 6885 A 6x6x32

Dimensions – Connection for flange size 60, 80, 100

Download CAD data → www.festo.com

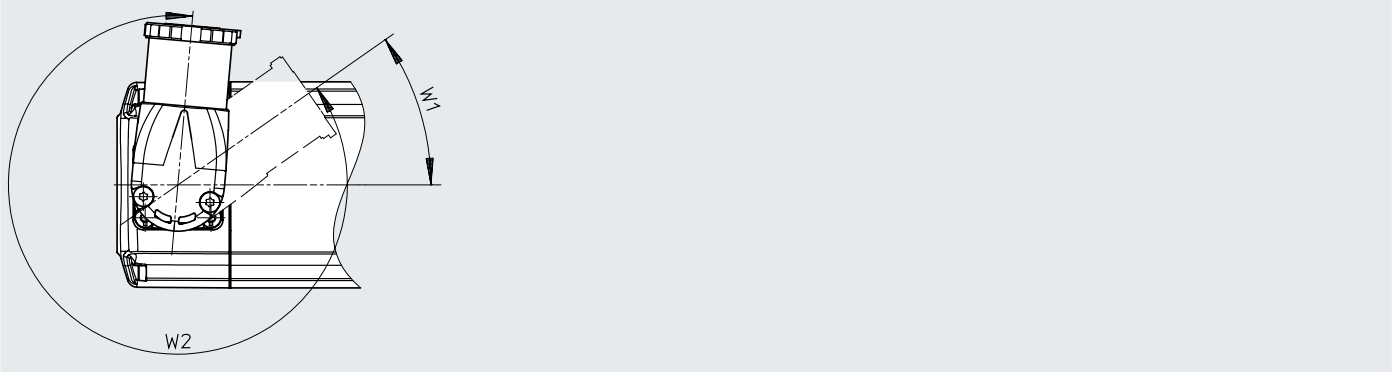

	W1	W2
EMMT-AS-...	-35°	310°

Datasheet

Dimensions – Flange size 150, 190

Download CAD data → www.festo.com

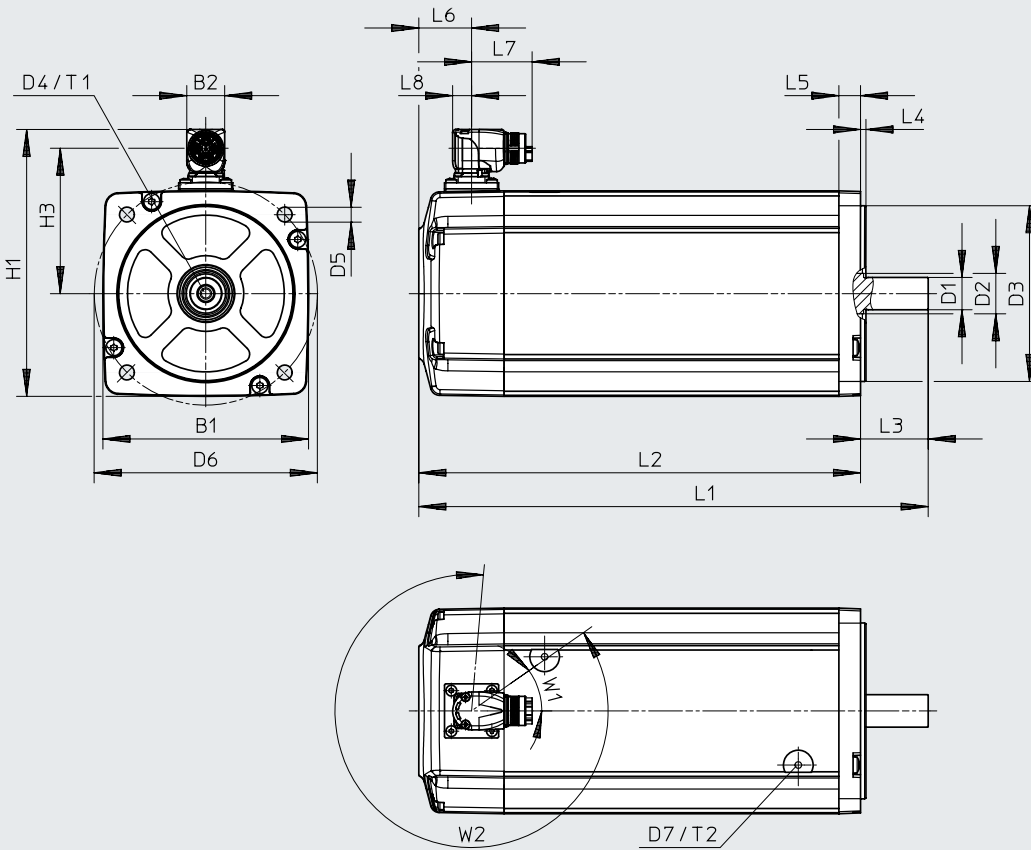

Note
 Only motors without feather key may be used in combination with parallel and axial kits (EAMM-U/EAMM-A).



	Length	Winding	Interface code, motor	B1	B2	D1 ø h6	D2 ø	D3 ø h7	D4	D5 ø	D6 ø ±0.3
150	M	HS	150A	152	28	24	30	130	M8	11	165
	L	HT			42.8						
	M	HV									
	L	HS									
190	M	HS	190B	190	42.8	32	40	180	M8	13.5	215
	L	HT									

	Length	Winding	D7	H1	H3	L1		L2		L3	L4 ±0.2
							With brake	±2	With brake ±2		
150	M	HS	M6	197.4	107.4	316.5	367.5	266.5	317.5	50 ^{+0.5/-1}	4
	L	HT				376.5	440.5	326.5	390.5		
	M	HV				316.5	367.5	266.5	317.5		
	L	HS				376.5	440.5	326.5	390.5		
190	M	HS	M8	258.3	137.3	414.5	477	356.5	419	58 ^{+0.5/-1}	5
	L	HT				474.5	537	416.5	479		

	Length	Winding	L5	L6	L7	L8	T1	T2	W1	W2
			±0.3							
150	M	HS	16	39	44.7	14	19	13	-35	310
	L	HT								
	M	HV								
	L	HS								
190	M	HS	18	46	80.9	19.9	28	13	-35	310
	L	HT								

Datasheet

Dimensions – Feather key for flange size 150, 190

Download CAD data → www.festo.com

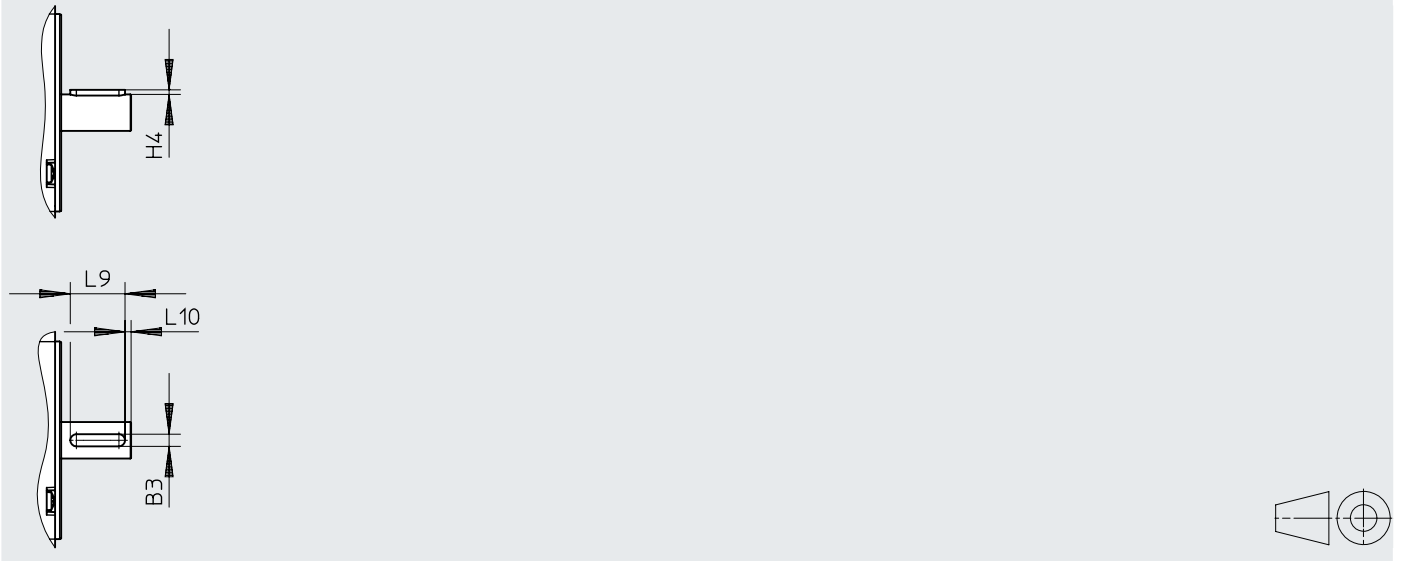

	B3	H4	L9	L10	Feather key
	h9		-0.2		
EMMT-AS-150-...-K	8	3	36	4	DIN 6885 A 8x7x36
EMMT-AS-190-...-K	10	3	45	4	DIN 6885 A 10x8x45

Dimensions – Connection for flange size 150, 190

Download CAD data → www.festo.com

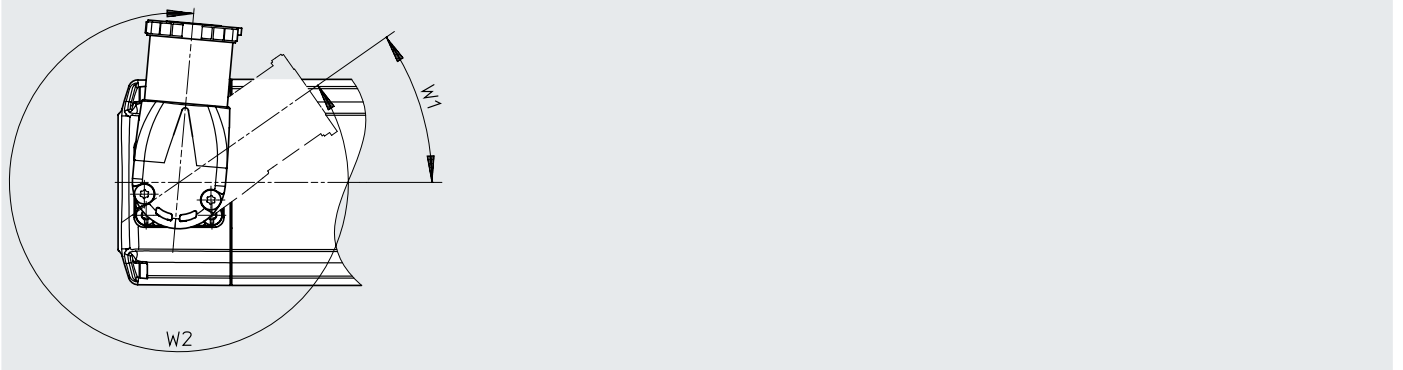

	W1	W2
EMMT-AS-...	-35°	310°

Datasheet

Ordering data												
Length				Winding		Measuring unit, encoder			Brake	Part no.	Type	
Short	Medium	Long	Very long	Low voltage, standard	High voltage, standard	Single-turn	Multi-turn	Safety, multi-turn				
Flange size 60												
■				■		■				5242196	EMMT-AS-60-S-LS-RS	
■				■			■			5242197	EMMT-AS-60-S-LS-RM	
■				■				■		8160630	EMMT-AS-60-S-LS-RMY	
■				■		■			■	5242198	EMMT-AS-60-S-LS-RSB	
■				■			■		■	5242199	EMMT-AS-60-S-LS-RMB	
■				■				■	■	8160631	EMMT-AS-60-S-LS-RMYB	
■					■	■				5242200	EMMT-AS-60-S-HS-RS	
■					■		■			5242201	EMMT-AS-60-S-HS-RM	
■					■			■		8160632	EMMT-AS-60-S-HS-RMY	
■					■	■			■	5242202	EMMT-AS-60-S-HS-RSB	
■					■		■		■	5242203	EMMT-AS-60-S-HS-RMB	
■					■			■	■	8160633	EMMT-AS-60-S-HS-RMYB	
	■			■		■				5242204	EMMT-AS-60-M-LS-RS	
	■			■			■			5242205	EMMT-AS-60-M-LS-RM	
	■			■				■		8160634	EMMT-AS-60-M-LS-RMY	
	■			■		■			■	5242206	EMMT-AS-60-M-LS-RSB	
	■			■			■		■	5242207	EMMT-AS-60-M-LS-RMB	
	■			■				■	■	8160635	EMMT-AS-60-M-LS-RMYB	
	■				■	■				5242208	EMMT-AS-60-M-HS-RS	
	■				■		■			5242209	EMMT-AS-60-M-HS-RM	
	■				■			■		8160636	EMMT-AS-60-M-HS-RMY	
	■				■	■			■	5242210	EMMT-AS-60-M-HS-RSB	
	■				■		■		■	5242211	EMMT-AS-60-M-HS-RMB	
	■				■			■	■	8160637	EMMT-AS-60-M-HS-RMYB	
		■		■		■				5242212	EMMT-AS-60-L-LS-RS	
		■		■			■			5242213	EMMT-AS-60-L-LS-RM	
		■		■				■		8160638	EMMT-AS-60-L-LS-RMY	
		■		■		■			■	5242214	EMMT-AS-60-L-LS-RSB	
		■		■			■		■	5242215	EMMT-AS-60-L-LS-RMB	
		■		■				■	■	8160639	EMMT-AS-60-L-LS-RMYB	
		■			■	■				5242216	EMMT-AS-60-L-HS-RS	
		■			■		■			5242217	EMMT-AS-60-L-HS-RM	
		■			■			■		8160640	EMMT-AS-60-L-HS-RMY	
		■			■	■			■	5242218	EMMT-AS-60-L-HS-RSB	
		■			■		■		■	5242219	EMMT-AS-60-L-HS-RMB	
		■			■			■	■	8160641	EMMT-AS-60-L-HS-RMYB	

Datasheet

Ordering data											
Length				Winding		Measuring unit, encoder			Brake	Part no.	Type
Short	Medium	Long	Very long	Low voltage, standard	High voltage, standard	Single-turn	Multi-turn	Safety, multi-turn			
Flange size 80											
■				■		■				5255425	EMMT-AS-80-S-LS-RS
■				■			■			5255426	EMMT-AS-80-S-LS-RM
■				■				■		8160642	EMMT-AS-80-S-LS-RMY
■				■		■			■	5255427	EMMT-AS-80-S-LS-RSB
■				■			■		■	5255428	EMMT-AS-80-S-LS-RMB
■				■				■	■	8160643	EMMT-AS-80-S-LS-RMYB
■					■	■				5255429	EMMT-AS-80-S-HS-RS
■					■		■			5255430	EMMT-AS-80-S-HS-RM
■					■			■		8160644	EMMT-AS-80-S-HS-RMY
■					■	■			■	5255431	EMMT-AS-80-S-HS-RSB
■					■		■		■	5255432	EMMT-AS-80-S-HS-RMB
■					■			■	■	8160645	EMMT-AS-80-S-HS-RMYB
	■			■		■				5255433	EMMT-AS-80-M-LS-RS
	■			■			■			5255434	EMMT-AS-80-M-LS-RM
	■			■				■		8160646	EMMT-AS-80-M-LS-RMY
	■			■		■			■	5255435	EMMT-AS-80-M-LS-RSB
	■			■			■		■	5255436	EMMT-AS-80-M-LS-RMB
	■			■				■	■	8160647	EMMT-AS-80-M-LS-RMYB
	■				■	■				5255437	EMMT-AS-80-M-HS-RS
	■				■		■			5255438	EMMT-AS-80-M-HS-RM
	■				■			■		8160648	EMMT-AS-80-M-HS-RMY
	■				■	■			■	5255439	EMMT-AS-80-M-HS-RSB
	■				■		■		■	5255440	EMMT-AS-80-M-HS-RMB
	■				■			■	■	8160649	EMMT-AS-80-M-HS-RMYB
		■		■		■				5255441	EMMT-AS-80-L-LS-RS
		■		■			■			5255442	EMMT-AS-80-L-LS-RM
		■		■				■		8160650	EMMT-AS-80-L-LS-RMY
		■		■		■			■	5255443	EMMT-AS-80-L-LS-RSB
		■		■			■		■	5255444	EMMT-AS-80-L-LS-RMB
		■		■				■	■	8160651	EMMT-AS-80-L-LS-RMYB
		■			■	■				5255445	EMMT-AS-80-L-HS-RS
		■			■		■			5255446	EMMT-AS-80-L-HS-RM
		■			■			■		8160652	EMMT-AS-80-L-HS-RMY
		■			■	■			■	5255447	EMMT-AS-80-L-HS-RSB
		■			■		■		■	5255448	EMMT-AS-80-L-HS-RMB
		■			■			■	■	8160653	EMMT-AS-80-L-HS-RMYB
			■		■	■				610909	EMMT-AS-80-H-HS-RS
			■		■		■			8172104	EMMT-AS-80-H-HS-RM
			■		■			■		8185112	EMMT-AS-80-H-HS-RMY
			■		■	■			■	610908	EMMT-AS-80-H-HS-RSB
			■		■		■		■	8172026	EMMT-AS-80-H-HS-RMB
			■		■			■	■	8185114	EMMT-AS-80-H-HS-RMYB

Datasheet

Ordering data											
Length				Winding		Measuring unit, encoder			Brake	Part no.	Type
Short	Medium	Long	Very long	Low voltage, standard	High voltage, standard	Single-turn	Multi-turn	Safety, multi-turn			
Flange size 100											
■					■	■				5255519	EMMT-AS-100-S-HS-RS
■					■		■			5255521	EMMT-AS-100-S-HS-RM
■					■			■		8160654	EMMT-AS-100-S-HS-RMY
■					■	■			■	5255528	EMMT-AS-100-S-HS-RSB
■					■		■		■	5255529	EMMT-AS-100-S-HS-RMB
■					■			■	■	8160655	EMMT-AS-100-S-HS-RMYB
	■				■	■				5255530	EMMT-AS-100-M-HS-RS
	■				■		■			5255531	EMMT-AS-100-M-HS-RM
	■				■			■		8160656	EMMT-AS-100-M-HS-RMY
	■				■	■			■	5255532	EMMT-AS-100-M-HS-RSB
	■				■		■		■	5255533	EMMT-AS-100-M-HS-RMB
	■				■			■	■	8160657	EMMT-AS-100-M-HS-RMYB
		■			■	■				5255534	EMMT-AS-100-L-HS-RS
		■			■		■			5255535	EMMT-AS-100-L-HS-RM
		■			■			■		8160658	EMMT-AS-100-L-HS-RMY
		■			■	■			■	5255536	EMMT-AS-100-L-HS-RSB
		■			■		■		■	5255537	EMMT-AS-100-L-HS-RMB
		■			■			■	■	8160659	EMMT-AS-100-L-HS-RMYB
			■		■	■				8182017	EMMT-AS-100-H-HS-RS
			■		■		■			8182016	EMMT-AS-100-H-HS-RM
			■		■			■		8160660	EMMT-AS-100-H-HS-RMY
			■		■	■			■	8182015	EMMT-AS-100-H-HS-RSB
			■		■		■		■	8182014	EMMT-AS-100-H-HS-RMB
			■		■			■	■	8160661	EMMT-AS-100-H-HS-RMYB

Datasheet

Ordering data		Winding			Measuring unit			Brake	Part no.	Type
Length		High voltage			Encoder					
Medium	Long	Standard	Speed- optimised	Torque- optimised	Single-turn	Multi-turn	Safety, multi-turn			
Flange size 150										
■		■			■				8148270	EMMT-AS-150-M-HS-R2S
■		■				■			8148271	EMMT-AS-150-M-HS-R2M
■		■					■		8148272	EMMT-AS-150-M-HS-R2MY
■		■			■			■	8148273	EMMT-AS-150-M-HS-R2SB
■		■				■		■	8148274	EMMT-AS-150-M-HS-R2MB
■		■					■	■	8148275	EMMT-AS-150-M-HS-R2MYB
■			■		■				8148276	EMMT-AS-150-M-HV-R3S
■			■			■			8148277	EMMT-AS-150-M-HV-R3M
■			■				■		8148278	EMMT-AS-150-M-HV-R3MY
■			■		■			■	8148279	EMMT-AS-150-M-HV-R3SB
■			■			■		■	8148280	EMMT-AS-150-M-HV-R3MB
■			■				■	■	8148281	EMMT-AS-150-M-HV-R3MYB
	■			■	■				8148318	EMMT-AS-150-L-HT-R2S
	■			■		■			8148319	EMMT-AS-150-L-HT-R2M
	■			■			■		8148320	EMMT-AS-150-L-HT-R2MY
	■			■	■			■	8148321	EMMT-AS-150-L-HT-R2SB
	■			■		■		■	8148322	EMMT-AS-150-L-HT-R2MB
	■			■			■	■	8148323	EMMT-AS-150-L-HT-R2MYB
	■	■			■				8148324	EMMT-AS-150-L-HS-R3S
	■	■				■			8148325	EMMT-AS-150-L-HS-R3M
	■	■					■		8148326	EMMT-AS-150-L-HS-R3MY
	■	■			■			■	8148327	EMMT-AS-150-L-HS-R3SB
	■	■				■		■	8148328	EMMT-AS-150-L-HS-R3MB
	■	■					■	■	8148329	EMMT-AS-150-L-HS-R3MYB
Flange size 190										
■		■			■				8148366	EMMT-AS-190-M-HS-R3S
■		■				■			8148367	EMMT-AS-190-M-HS-R3M
■		■					■		8148368	EMMT-AS-190-M-HS-R3MY
■		■			■			■	8148369	EMMT-AS-190-M-HS-R3SB
■		■				■		■	8148370	EMMT-AS-190-M-HS-R3MB
■		■					■	■	8148371	EMMT-AS-190-M-HS-R3MYB
	■			■	■				8148390	EMMT-AS-190-L-HT-R3S
	■			■		■			8148391	EMMT-AS-190-L-HT-R3M
	■			■			■		8148392	EMMT-AS-190-L-HT-R3MY
	■			■	■			■	8148393	EMMT-AS-190-L-HT-R3SB
	■			■		■		■	8148394	EMMT-AS-190-L-HT-R3MB
	■			■			■	■	8148395	EMMT-AS-190-L-HT-R3MYB

Datasheet

Ordering data – With feather key										
Length		Winding			Measuring unit			Brake	Part no.	Type
Medium	Long	High voltage		Encoder						
		Standard	Speed- optimised	Torque- optimised	Single-turn	Multi-turn	Safety, multi-turn			
Flange size 150										
■		■			■				8148282	EMMT-AS-150-MK-HS-R2S
■		■				■			8148283	EMMT-AS-150-MK-HS-R2M
■		■					■		8148284	EMMT-AS-150-MK-HS-R2MY
■		■			■			■	8148285	EMMT-AS-150-MK-HS-R2SB
■		■				■		■	8148286	EMMT-AS-150-MK-HS-R2MB
■		■					■	■	8148287	EMMT-AS-150-MK-HS-R2MYB
■			■		■				8148288	EMMT-AS-150-MK-HV-R3S
■			■			■			8148289	EMMT-AS-150-MK-HV-R3M
■			■				■		8148290	EMMT-AS-150-MK-HV-R3MY
■			■		■			■	8148291	EMMT-AS-150-MK-HV-R3SB
■			■			■		■	8148292	EMMT-AS-150-MK-HV-R3MB
■			■				■	■	8148293	EMMT-AS-150-MK-HV-R3MYB
	■			■	■				8148330	EMMT-AS-150-LK-HT-R2S
	■			■		■			8148331	EMMT-AS-150-LK-HT-R2M
	■			■			■		8148332	EMMT-AS-150-LK-HT-R2MY
	■			■	■			■	8148333	EMMT-AS-150-LK-HT-R2SB
	■			■		■		■	8148334	EMMT-AS-150-LK-HT-R2MB
	■			■			■	■	8148335	EMMT-AS-150-LK-HT-R2MYB
	■	■			■				8148336	EMMT-AS-150-LK-HS-R3S
	■	■				■			8148337	EMMT-AS-150-LK-HS-R3M
	■	■					■		8148338	EMMT-AS-150-LK-HS-R3MY
	■	■			■			■	8148339	EMMT-AS-150-LK-HS-R3SB
	■	■				■		■	8148340	EMMT-AS-150-LK-HS-R3MB
	■	■					■	■	8148341	EMMT-AS-150-LK-HS-R3MYB
Flange size 190										
■		■			■				8148372	EMMT-AS-190-MK-HS-R3S
■		■				■			8148373	EMMT-AS-190-MK-HS-R3M
■		■					■		8148374	EMMT-AS-190-MK-HS-R3MY
■		■			■			■	8148375	EMMT-AS-190-MK-HS-R3SB
■		■				■		■	8148376	EMMT-AS-190-MK-HS-R3MB
■		■					■	■	8148377	EMMT-AS-190-MK-HS-R3MYB
	■			■	■				8148396	EMMT-AS-190-LK-HT-R3S
	■			■		■			8148397	EMMT-AS-190-LK-HT-R3M
	■			■			■		8148398	EMMT-AS-190-LK-HT-R3MY
	■			■	■			■	8148399	EMMT-AS-190-LK-HT-R3SB
	■			■		■		■	8148400	EMMT-AS-190-LK-HT-R3MB
	■			■			■	■	8148401	EMMT-AS-190-LK-HT-R3MYB

Datasheet

Ordering data – With rotary shaft seal										
Length		Winding			Measuring unit			Brake	Part no.	Type
Medium	Long	High voltage		Encoder						
		Standard	Speed-optimised	Torque-optimised	Single-turn	Multi-turn	Safety, multi-turn			
Flange size 150										
■		■			■				8148294	EMMT-AS-150-MR-HS-R2S
■		■				■			8148295	EMMT-AS-150-MR-HS-R2M
■		■					■		8148296	EMMT-AS-150-MR-HS-R2MY
■		■			■			■	8148297	EMMT-AS-150-MR-HS-R2SB
■		■				■		■	8148298	EMMT-AS-150-MR-HS-R2MB
■		■					■	■	8148299	EMMT-AS-150-MR-HS-R2MYB
■			■		■				8148300	EMMT-AS-150-MR-HV-R3S
■			■			■			8148301	EMMT-AS-150-MR-HV-R3M
■			■				■		8148302	EMMT-AS-150-MR-HV-R3MY
■			■		■			■	8148303	EMMT-AS-150-MR-HV-R3SB
■			■			■		■	8148304	EMMT-AS-150-MR-HV-R3MB
■			■				■	■	8148305	EMMT-AS-150-MR-HV-R3MYB
	■			■	■				8148342	EMMT-AS-150-LR-HT-R2S
	■			■		■			8148343	EMMT-AS-150-LR-HT-R2M
	■			■			■		8148344	EMMT-AS-150-LR-HT-R2MY
	■			■	■			■	8148345	EMMT-AS-150-LR-HT-R2SB
	■			■		■		■	8148346	EMMT-AS-150-LR-HT-R2MB
	■			■			■	■	8148347	EMMT-AS-150-LR-HT-R2MYB
	■	■			■				8148348	EMMT-AS-150-LR-HS-R3S
	■	■				■			8148349	EMMT-AS-150-LR-HS-R3M
	■	■					■		8148350	EMMT-AS-150-LR-HS-R3MY
	■	■			■			■	8148351	EMMT-AS-150-LR-HS-R3SB
	■	■				■		■	8148352	EMMT-AS-150-LR-HS-R3MB
	■	■					■	■	8148353	EMMT-AS-150-LR-HS-R3MYB
Flange size 190										
■		■			■				8148378	EMMT-AS-190-MR-HS-R3S
■		■				■			8148379	EMMT-AS-190-MR-HS-R3M
■		■					■		8148380	EMMT-AS-190-MR-HS-R3MY
■		■			■			■	8148381	EMMT-AS-190-MR-HS-R3SB
■		■				■		■	8148382	EMMT-AS-190-MR-HS-R3MB
■		■					■	■	8148383	EMMT-AS-190-MR-HS-R3MYB
	■			■	■				8148402	EMMT-AS-190-LR-HT-R3S
	■			■		■			8148403	EMMT-AS-190-LR-HT-R3M
	■			■			■		8148404	EMMT-AS-190-LR-HT-R3MY
	■			■	■			■	8148405	EMMT-AS-190-LR-HT-R3SB
	■			■		■		■	8148406	EMMT-AS-190-LR-HT-R3MB
	■			■			■	■	8148407	EMMT-AS-190-LR-HT-R3MYB

Datasheet

Ordering data – With feather key and rotary shaft seal										
Length		Winding			Measuring unit			Brake	Part no.	Type
Medium	Long	High voltage			Encoder					
		Standard	Speed- optimised	Torque- optimised	Single-turn	Multi-turn	Safety, multi-turn			
Flange size 150										
■		■			■				8148306	EMMT-AS-150-MKR-HS-R2S
■		■				■			8148307	EMMT-AS-150-MKR-HS-R2M
■		■					■		8148308	EMMT-AS-150-MKR-HS-R2MY
■		■			■			■	8148309	EMMT-AS-150-MKR-HS-R2SB
■		■				■		■	8148310	EMMT-AS-150-MKR-HS-R2MB
■		■					■	■	8148311	EMMT-AS-150-MKR-HS-R2MYB
■			■		■				8148312	EMMT-AS-150-MKR-HV-R3S
■			■			■			8148313	EMMT-AS-150-MKR-HV-R3M
■			■				■		8148314	EMMT-AS-150-MKR-HV-R3MY
■			■		■			■	8148315	EMMT-AS-150-MKR-HV-R3SB
■			■			■		■	8148316	EMMT-AS-150-MKR-HV-R3MB
■			■				■	■	8148317	EMMT-AS-150-MKR-HV-R3MYB
	■			■	■				8148354	EMMT-AS-150-LKR-HT-R2S
	■			■		■			8148355	EMMT-AS-150-LKR-HT-R2M
	■			■			■		8148356	EMMT-AS-150-LKR-HT-R2MY
	■			■	■			■	8148357	EMMT-AS-150-LKR-HT-R2SB
	■			■		■		■	8148358	EMMT-AS-150-LKR-HT-R2MB
	■			■			■	■	8148359	EMMT-AS-150-LKR-HT-R2MYB
	■	■			■				8148360	EMMT-AS-150-LKR-HS-R3S
	■	■				■			8148361	EMMT-AS-150-LKR-HS-R3M
	■	■					■		8148362	EMMT-AS-150-LKR-HS-R3MY
	■	■			■			■	8148363	EMMT-AS-150-LKR-HS-R3SB
	■	■				■		■	8148364	EMMT-AS-150-LKR-HS-R3MB
	■	■					■	■	8148365	EMMT-AS-150-LKR-HS-R3MYB
Flange size 190										
■		■			■				8148384	EMMT-AS-190-MKR-HS-R3S
■		■				■			8148385	EMMT-AS-190-MKR-HS-R3M
■		■					■		8148386	EMMT-AS-190-MKR-HS-R3MY
■		■			■			■	8148387	EMMT-AS-190-MKR-HS-R3SB
■		■				■		■	8148388	EMMT-AS-190-MKR-HS-R3MB
■		■					■	■	8148389	EMMT-AS-190-MKR-HS-R3MYB
	■			■	■				8148408	EMMT-AS-190-LKR-HT-R3S
	■			■		■			8148409	EMMT-AS-190-LKR-HT-R3M
	■			■			■		8148410	EMMT-AS-190-LKR-HT-R3MY
	■			■	■			■	8148411	EMMT-AS-190-LKR-HT-R3SB
	■			■		■		■	8148412	EMMT-AS-190-LKR-HT-R3MB
	■			■			■	■	8148413	EMMT-AS-190-LKR-HT-R3MYB

Ordering data – Modular product system

Ordering table						
Size	60	80	100	Conditions	Code	Enter code
Module no.	4808568	4595815	5185818			
Series	EMMT				EMMT	EMMT
Motor technology	AC synchronous				-AS	-AS
Motor flange size	60 mm	80 mm	100 mm		-	-
Length	Short				-S	
	Medium				-M	
	Long				-L	
	-	Very long			-H	
Output shaft	Smooth shaft					
	Shaft to DIN 6885				K	
Radial shaft seal	None					
	With standard shaft seal			[1]	R	
Winding	Low voltage, standard			[2]	-LS	
	High voltage, standard				-HS	
Electrical connection	Angled plug, rotatable				-R	-R
Measuring unit	Absolute encoder, single-turn				S	
	Absolute encoder, multi-turn				M	
	Absolute safety encoder, multi-turn, EnDat				MY	
Brake	None					
	With brake				B	

[1] R When using the radial shaft seal, a reduction (derating) of the nominal torque of 10% must be taken into account

[2] LS Not in combination with length H

Accessories

Ordering data – Gear unit

Datasheets → Internet: emga

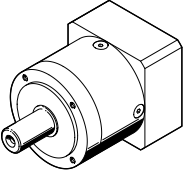

For motor	Gear ratio	Part no.	Type
EMMT-AS-60	3	2297686	EMGA-60-P-G3-EAS-60
	5	2297687	EMGA-60-P-G5-EAS-60
	8	8141735	EMGA-60-P-G8-EAS-60
	12	8141736	EMGA-60-P-G12-EAS-60
	20	8141737	EMGA-60-P-G20-EAS-60
EMMT-AS-80	3	2297690	EMGA-80-P-G3-EAS-80
	5	2297691	EMGA-80-P-G5-EAS-80
	8	8141741	EMGA-80-P-G8-EAS-80
	12	8141742	EMGA-80-P-G12-EAS-80
	20	8141743	EMGA-80-P-G20-EAS-80
EMMT-AS-100	3	552194	EMGA-80-P-G3-SAS-100
	5	552195	EMGA-80-P-G5-SAS-100
	8	8141750	EMGA-80-P-G8-SAS-100
	12	8141751	EMGA-80-P-G12-SAS-100
	20	8141752	EMGA-80-P-G20-SAS-100
	3	552196	EMGA-120-P-G3-SAS-100
	5	552197	EMGA-120-P-G5-SAS-100
	8	8141753	EMGA-120-P-G8-SAS-100
	12	8141754	EMGA-120-P-G12-SAS-100
	20	8141755	EMGA-120-P-G20-SAS-100
EMMT-AS-150	3	552198	EMGA-120-P-G3-SAS-140
	5	552199	EMGA-120-P-G5-SAS-140
	8	8141759	EMGA-120-P-G8-SAS-140
	12	8141760	EMGA-120-P-G12-SAS-140
	20	8141761	EMGA-120-P-G20-SAS-140
	3	552200	EMGA-160-P-G3-SAS-140
5	552201	EMGA-160-P-G5-SAS-140	

Ordering data – Right-angle gear unit

Datasheets → Internet: emga

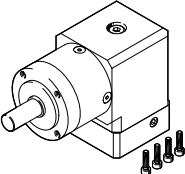

For motor	Gear ratio	Part no.	Type
EMMT-AS-60	3	8085344	EMGA-60-A-G3-60P
	5	8085345	EMGA-60-A-G5-60P
	8	8141738	EMGA-60-A-G8-60P
	12	8141739	EMGA-60-A-G12-60P
	20	8141740	EMGA-60-A-G20-60P
EMMT-AS-80	3	8085346	EMGA-80-A-G3-80P
	5	8085347	EMGA-80-A-G5-80P
	8	8141744	EMGA-80-A-G8-80P
	12	8141745	EMGA-80-A-G12-80P
	20	8141746	EMGA-80-A-G20-80P
EMMT-AS-100	3	8085348	EMGA-80-A-G3-100A
	5	8085349	EMGA-80-A-G5-100A
	8	8141747	EMGA-80-A-G8-100A
	12	8141748	EMGA-80-A-G12-100A
	20	8141749	EMGA-80-A-G20-100A

Accessories

Ordering data – Rotary shaft seal				
	For flange size	Description	Part no.	Type
	60	<ul style="list-style-type: none"> For the motors EMMT-AS Protection to IP65 is achieved in combination with the sealing ring Based on the operating conditions, the shaft seal must be replaced after a maximum of 5000 operating hours When using the radial shaft seal, a reduction (derating) of the nominal torque of 10% must be taken into account Information on installation/replacement → www.festo.com/sp 	8079786	EASS-RS-T-A-4P-15-30-B7
	80, 100		8079785	EASS-RS-T-A-4P-20-40-B7
	150		8154298	EASS-RS-T-A-4P-30-42-B7
	190		8154299	EASS-RS-T-A-4P-40-55-B7

Recommended cable cross section at an ambient temperature of 40 °C as a function of cable length and servo drive CMMT-AS

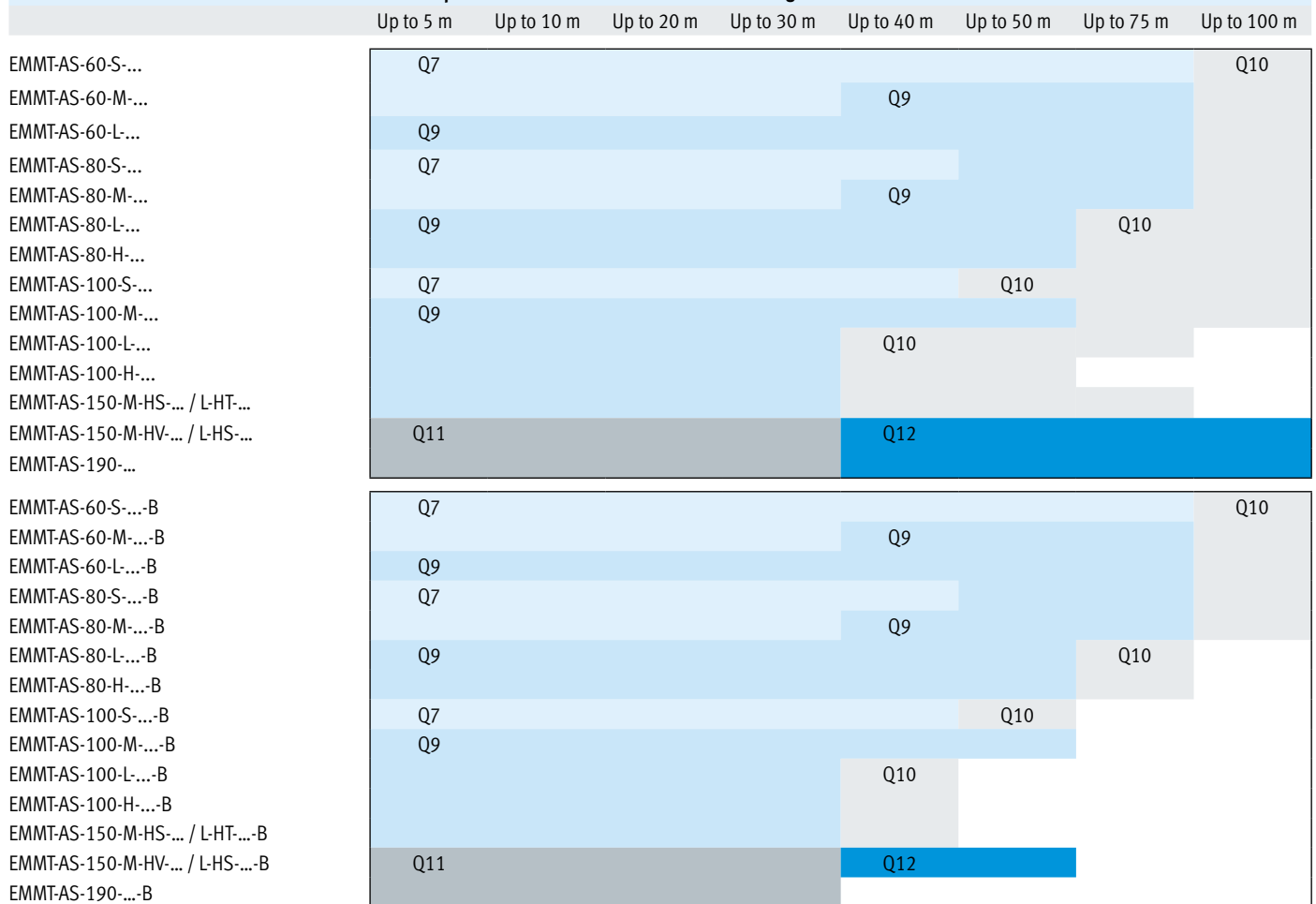

- Q7 = 0.75 mm²
- Q9 = 1.5 mm²
- Q10 = 2.5 mm²
- Q11 = 4 mm²
- Q12 = 6 mm²
- no cable recommendation

 Note

- When using other servo drives, the max. cable lengths may be shorter or the cable cross sections may be different.
- For cable lengths > 25 m, prior technical clarification is recommended.
- Motors with a holding brake require a logic power supply of UB ≥ 24 V DC. In this case, the recommended motor cables from Festo with the appropriate cross sections should also be used.
- This recommendation is made on the basis that the servo drive is connected to the supply network via a short connecting cable and network-side voltage drops can therefore be neglected.

Accessories

Technical data – Motor cables			
Cable cross section	0.75 mm ²	1.5 mm ²	2.5 mm ²
Type	NEBM-M23G15-...-Q7N	NEBM-M23G15-...-Q9N	NEBM-M23G15-...-Q10N
Cable composition	4x 0.75 mm ² + 1x (2x 0.75 mm ²) + 1x (2x 0.24 mm ² + 2x 2x0.15 mm ²)	4x 1.5 mm ² + 1x (2x 0.75 mm ²) + 1x (2x 0.24 mm ² + 2x 2x 0.15 mm ²)	4x 2.5 mm ² + 1x (2x 1.0 mm ²) + 1x (2x 0.24 mm ² + 2x 2x 0.15 mm ²)
	Shielded		
Cable diameter [mm]	12	12.8	13.9
Min. bending radius			
With fixed cable installation [mm]	≥ 48	≥ 51.2	≥ 55.6
With flexible cable installation [mm]	≥ 90	≥ 96	≥ 97.3
Pollution degree	1	3	3
Ambient temperature			
With fixed cable installation [°C]	-40 ... +90		
With flexible cable installation [°C]	-25 ... +80		
Cable characteristic	Suitable for energy chains		
Degree of protection	IP67 (when mounted)		
Material	TPE-U (PUR)		
Note on materials	RoHS-compliant		
LABS (PWIS) conformity	VDMA24364-B2-L		
CE marking (see declaration of conformity)	To EU Low Voltage Directive To EU RoHS Directive		
UKCA marking (see declaration of conformity)	To UK regulations for electrical equipment To UK RoHS regulations		

Technical data – Motor cables		
Cable cross section	4 mm ²	6 mm ²
Type	NEBM-M40G15-...-Q11N	NEBM-M40G15-...-Q12N
Cable composition	4x 4 mm ² + 1x (2x 1.5 mm ²) + 1x (2x 0.24 mm ² + 2x 2x 0.15 mm ²)	4x 6 mm ² + 1x (2x 1.5 mm ²) + 1x (2x 0.24 mm ² + 2x 2x 0.15 mm ²)
	Shielded	
Cable diameter [mm]	16.4	18.7
Min. bending radius		
With fixed cable installation [mm]	≥ 65.6	≥ 74.8
With flexible cable installation [mm]	≥ 123	≥ 140.25
Pollution degree	3	3
Ambient temperature		
With fixed cable installation [°C]	-40 ... +90	
With flexible cable installation [°C]	-25 ... +80	
Cable characteristic	Suitable for energy chains	
Degree of protection	IP67 (when mounted)	
Material	TPE-U (PUR)	
Note on materials	RoHS-compliant	
LABS (PWIS) conformity	VDMA24364-B2-L	
CE marking (see declaration of conformity)	To EU Low Voltage Directive To EU RoHS Directive	
UKCA marking (see declaration of conformity)	To UK regulations for electrical equipment To UK RoHS regulations	

Accessories

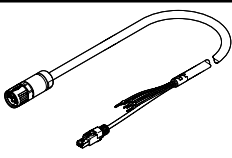
Ordering data – Motor cable for servo drive CMMT-AS				
	Cable cross section	Cable length [m]	Part no.	Type
	0.75 mm ²	2.5	5251374	NEBM-M23G15-EH-2.5-Q7N-R3LEG14
		5	5251375	NEBM-M23G15-EH-5-Q7N-R3LEG14
		7.5	5251376	NEBM-M23G15-EH-7.5-Q7N-R3LEG14
		10	5251377	NEBM-M23G15-EH-10-Q7N-R3LEG14
		15	5251378	NEBM-M23G15-EH-15-Q7N-R3LEG14
		20	5251379	NEBM-M23G15-EH-20-Q7N-R3LEG14
		X length ¹⁾	5251373	NEBM-M23G15-EH-...-Q7N-R3LEG14
	1.5 mm ²	2.5	5251381	NEBM-M23G15-EH-2.5-Q9N-R3LEG14
		5	5251382	NEBM-M23G15-EH-5-Q9N-R3LEG14
		7.5	5251383	NEBM-M23G15-EH-7.5-Q9N-R3LEG14
		10	5251384	NEBM-M23G15-EH-10-Q9N-R3LEG14
		15	5251385	NEBM-M23G15-EH-15-Q9N-R3LEG14
		20	5251386	NEBM-M23G15-EH-20-Q9N-R3LEG14
		X length ¹⁾	5251380	NEBM-M23G15-EH-...-Q9N-R3LEG14
	2.5 mm ²	2.5	5251388	NEBM-M23G15-EH-2.5-Q10N-R3LEG14
		5	5251389	NEBM-M23G15-EH-5-Q10N-R3LEG14
		7.5	5251390	NEBM-M23G15-EH-7.5-Q10N-R3LEG14
		10	5251391	NEBM-M23G15-EH-10-Q10N-R3LEG14
		15	5251392	NEBM-M23G15-EH-15-Q10N-R3LEG14
		20	5251393	NEBM-M23G15-EH-20-Q10N-R3LEG14
		X length ¹⁾	5251387	NEBM-M23G15-EH-...-Q10N-R3LEG14
	4 mm ²	2.5	5251395	NEBM-M40G15-EH-2.5-Q11N-R3LEG14
		5	5251396	NEBM-M40G15-EH-5-Q11N-R3LEG14
		7.5	5251397	NEBM-M40G15-EH-7.5-Q11N-R3LEG14
		10	5251398	NEBM-M40G15-EH-10-Q11N-R3LEG14
		15	5251399	NEBM-M40G15-EH-15-Q11N-R3LEG14
		20	5251400	NEBM-M40G15-EH-20-Q11N-R3LEG14
		X length ¹⁾	5251394	NEBM-M40G15-EH-...-Q11N-R3LEG14
6 mm ²	X length ¹⁾	5251401	NEBM-M40G15-EH-...-Q12N-R3LEG14	

1) Choice of cable lengths: 0.5 ... 99.9 m, in increments of 0.1 m.

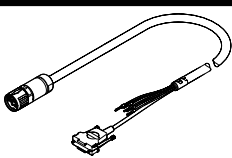
Ordering data – Motor cable for motor controller CMMF-AS				
	Cable cross section	Cable length [m]	Part no.	Type
	0.75 mm ²	5	8190885	NEBM-M23G15-EH-2.5-Q7N-S1LEG21
		7.5	8190886	NEBM-M23G15-EH-7.5-Q7N-S1LEG21
		10	8190887	NEBM-M23G15-EH-10-Q7N-S1LEG21
		X length ¹⁾	8190874	NEBM-M23/40
	1.5 mm ²	5	8190888	NEBM-M23G15-EH-2.5-Q9N-S1LEG21
		7.5	8190889	NEBM-M23G15-EH-7.5-Q9N-S1LEG21
		10	8190890	NEBM-M23G15-EH-10-Q9N-S1LEG21
		X length ¹⁾	8190874	NEBM-M23/40
	4 mm ²	X length ¹⁾	8190874	NEBM-M23/40
	6 mm ²	X length ¹⁾	8190874	NEBM-M23/40

1) Choice of cable lengths: 0.5 ... 99.9 m, in increments of 0.1 m.

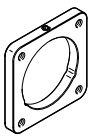
Ordering data – Mounting flange for fitting the motor cable plug (e.g. on the control cabinet)			
	Note on materials	Part no.	Type
	RoHS-compliant	8201098	NEAM-MF-M23
		8201099	NEAM-MF-M40