

## Stepper motors EMMB-ST

**FESTO**

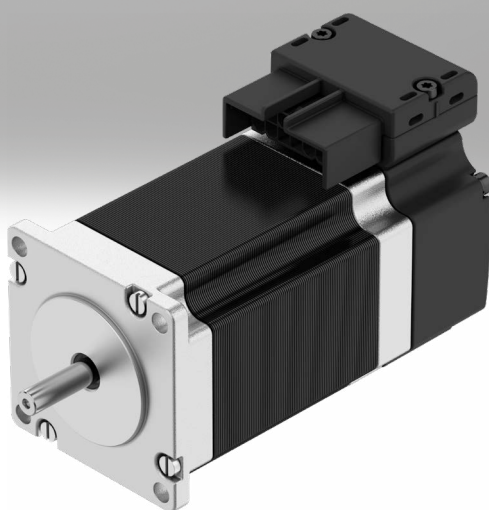

## Key features

### At a glance

- Two-phase hybrid technology
- 3 flange sizes available: M = 0.25 ... 6.6 Nm
- Degree of protection IP20 for motor housing with connection technology
- Degree of protection IP40 for motor shaft

### Connection technology:

- Simple connection technology (OCP: one cable plug) – hybrid cable: motor cable and connecting cable for supply and encoder in one
- Forward or backward orientation possible

### Digital absolute encoder system:

- Single-turn
- Multi-turn, battery-free

### Engineering tools

More information → [electric motion sizing](#)



Save time with smart engineering tools for the optimal solution. Our goal is to increase your productivity. Our engineering tools play an integral part in achieving this goal. They help you size your system correctly, tap into unimagined productivity reserves and generate additional productivity along the entire value chain. In every phase of your project, from the initial contact to the modernisation of your machine, you will come across a number of different tools which will be of use to you.

### Electric Motion Sizing

- Create the optimum drive package quickly and reliably. Electric Motion Sizing calculates suitable combinations of electric axis, electric motor and servo drive using just a few application details. It provides you with all the relevant data including the bill of materials and documentation for the selected combination. This avoids design errors and results in significantly improved energy efficiency for the system. A smooth connection to the Festo Automation Suite also makes commissioning easier for you.

### Graphs

More information → [emmb-st](#)



The graphs shown in this document are also available online. There, precise values can be displayed.

### Measuring unit

[S]	Absolute encoder, single-turn	[M]	Absolute encoder, multi-turn
• The angular position is assigned to a unique value in coded form.		• A unique value in coded form is assigned to the angular position and each full turn.	
• The position is only sensed within one turn. All subsequent turns need to be counted by the higher-level device.		• This type counts the full turns until the specified maximum is reached (including when switched off).	
• When switched off, the position is only sensed within one turn.		• Homing is only required once it has been installed in the application.	
• A homing run is required after switch-on.			

### Brake

[B]	With brake
-----	------------

The holding brake should not be used as a safety brake.

## Type codes

001	Series
EMMB	Motor

002	Motor type
ST	Stepper motor ST

003	Flange size, motors [mm]
42	42
57	57
87	87

004	Length
L	Long
M	Medium
S	Short

005	Electrical connection
S	Straight plug

006	Measuring unit
	None
M	Absolute encoder, multi-turn
S	Absolute encoder, single turn

007	Brake
	None
B	With brake

Datasheet

General technical data - EMMB-ST-42						
Flange size, motors [mm]	42 mm					
Length	[S]			[L]		
Measuring unit	[ ]	[M]	[S]	[ ]	[M]	[S]
Nominal operating voltage DC	48 V					
Nominal motor current	1.8 A			2.9 A		
Continuous stall current	2 A			3.7 A		
Peak current	2 A			4 A		
Rated motor output <sup>1)</sup>	–		17 W	–		49 W
Step angle with full step	1.8 deg					
Stepping angle tolerance	±5%					
Motor holding torque	0.25 Nm			0.63 Nm		
Nominal torque <sup>1)</sup>	–		0.24 Nm	–		0.47 Nm
Peak torque	0.25 Nm			0.63 Nm		
Nominal rotational speed <sup>1)</sup>	–		600 rpm	–		1,000 rpm
Maximum speed	2,700 rpm			3,200 rpm		
Max. mechanical rotational speed	9,000 rpm					
Motor constant	0.159 Nm/A			0.162 Nm/A		
Voltage constant phase	12.1 mV/min			10.6 mV/min		
Electric time constant	1.4 ms			1.3 ms		
Thermal time constant	22 mins			16 mins		
Thermal resistance	3.5 K/W			2.4 K/W		
I <sup>2</sup> T time motor	2 s					
Number of phases	2					
Number of pole pairs	50					
Winding resistance phase	2.1 Ohm			0.6 Ohm		
Winding inductance phase per individual phase (un-linked)	3 mH			0.8 mH		
Winding series inductance Ld (phase)	1.6 mH			1.45 mH		
Winding shunt inductance Lq (phase)	3 mH			0.8 mH		
Permissible axial shaft load	10 N					
Permissible radial shaft load	28 N					
Measuring flange	200 x 200 x 15 mm, steel					

1) For motors without encoders, no nominal operating point is defined.

## Datasheet

General technical data - EMMB-ST-57						
Flange size, motors [mm]	57 mm					
Length	[M]			[L]		
Measuring unit	[ ]	[M]	[S]	[ ]	[M]	[S]
Nominal operating voltage DC	48 V					
Nominal motor current	5.1 A			5 A		
Continuous stall current	6.1 A			5.8 A		
Peak current	8 A					
Rated motor output <sup>1)</sup>	–	81 W		–	83 W	
Step angle with full step	1.8 deg					
Stepping angle tolerance	±5%					
Motor holding torque	1.05 Nm			1.8 Nm		
Nominal torque <sup>1)</sup>	–	0.77 Nm		–	1.58 Nm	
Peak torque	1.1 Nm			2.1 Nm		
Nominal rotational speed <sup>1)</sup>	–	1,000 rpm		–	500 rpm	
Maximum speed	2,600 rpm			1,500 rpm		
Max. mechanical rotational speed	8,000 rpm					
Motor constant	0.152 Nm/A			0.32 Nm/A		
Voltage constant phase	13.1 mV/min			22.6 mV/min		
Electric time constant	2.9 ms			3.7 ms		
Thermal time constant	28 mins			32 mins		
Thermal resistance	1.6 K/W			1.5 K/W		
I <sup>2</sup> T time motor	2 s					
Number of phases	2					
Number of pole pairs	50					
Winding resistance phase	0.17 Ohm			0.26 Ohm		
Winding inductance phase per individual phase (un-linked)	0.5 mH			0.95 mH		
Winding series inductance L <sub>d</sub> (phase)	0.7 mH			1.75 mH		
Winding shunt inductance L <sub>q</sub> (phase)	0.5 mH			0.95 mH		
Permissible axial shaft load	15 N					
Permissible radial shaft load	75 N					
Measuring flange	200 x 200 x 15 mm, steel					

1) For motors without encoders, no nominal operating point is defined.

Datasheet

General technical data - EMMB-ST-87						
Flange size, motors [mm]	87 mm					
Length	[S]			[M]		
Measuring unit	[ ]	[M]	[S]	[ ]	[M]	[S]
Nominal operating voltage DC	48 V					
Nominal motor current	6.9 A			7.5 A		
Continuous stall current	9.5 A			8.2 A		
Peak current	12 A					
Rated motor output <sup>1)</sup>	–		142 W	–		87 W
Step angle with full step	1.8 deg					
Stepping angle tolerance	±5%					
Motor holding torque	2.4 Nm			6.6 Nm		
Nominal torque <sup>1)</sup>	–		1.7 Nm	–		5.9 Nm
Peak torque	2.7 Nm			6.8 Nm		
Nominal rotational speed <sup>1)</sup>	–		800 rpm	–		140 rpm
Maximum speed	2,200 rpm			600 rpm		
Max. mechanical rotational speed	8,000 rpm					
Motor constant	0.24 Nm/A			0.79 Nm/A		
Voltage constant phase	15.4 mV/min			56.6 mV/min		
Electric time constant	1.75 ms			8.5 ms		
Thermal time constant	37 mins			33 mins		
Thermal resistance	0.91 K/W			0.88 K/W		
I <sup>2</sup> T time motor	2 s					
Number of phases	2					
Number of pole pairs	50					
Winding resistance phase	0.13 Ohm			0.27 Ohm		
Winding inductance phase per individual phase (un-linked)	0.35 mH			2.3 mH		
Winding series inductance Ld (phase)	0.56 mH			3.6 mH		
Winding shunt inductance Lq (phase)	0.35 mH			2.3 mH		
Permissible axial shaft load	60 N					
Permissible radial shaft load	220 N					
Measuring flange	250 x 250 x 15 mm, steel					

1) For motors without encoders, no nominal operating point is defined.

## Datasheet

## Technical data - Brakes

Flange size, motors [mm]	42	57	87
Brake holding torque	0.63 Nm	1.74 Nm	4.26 Nm
Brake DC operating voltage	24 V		
Brake current consumption	0.34 A	0.38 A	0.49 A
Brake power consumption	8.2 W	9 W	12 W
Brake coil resistance	70.9 Ohm	63.8 Ohm	49.2 Ohm
Brake coil inductivity	146 mH	107 mH	110 mH
Brake separation time	28 ms	32 ms	44 ms
Brake closing time	41 ms	97 ms	110 ms
DC brake response delay	8 ms	11 ms	30 ms
Max. brake no-load speed	9,000 rpm	8,000 rpm	7,000 rpm
Brake max. friction	1,500 J	6,000 J	14,000 J
Mass moment of inertia, brake	0.006 kgcm <sup>2</sup>	0.024 kgcm <sup>2</sup>	0.11 kgcm <sup>2</sup>
Switching cycles, holding brake	10 million idle actuations (without friction!)		

## Technical data – Encoder

Flange size, motors [mm]	42		57		87	
Measuring unit	[S]	[M]	[S]	[M]	[S]	[M]
Rotor position sensor measuring principle	Magnetic					
Rotary position encoder interface	BiSS-C					
Rotor position encoder for absolute detectable revolutions	–	65,536	–	65,536	–	65,536
Rotor position encoder, DC operating voltage	5 V			14 V	5 V	14 V
Rotor position encoder, DC operating voltage range	4.75 ... 5.25 V	4.5 ... 5.5 V	4.75 ... 5.25 V	4.75 ... 15 V	4.75 ... 5.25 V	4.75 ... 15 V
Rotor position encoder, sinusoidal/cosinusoidal periods per revolution	2					
Rotor position encoder, position values per revolution	65,536	131,072	65,536	131,072	65,536	131,072
Rotor position encoder resolution	16 bit	17 bit	16 bit	17 bit	16 bit	17 bit
Rotor position encoder, system accuracy of angle measurement	-540 ... 540 arcsec	-310 ... 310 arcsec	-540 ... 540 arcsec	-310 ... 310 arcsec	-540 ... 540 arcsec	-310 ... 310 arcsec
Rotor position encoder, max. operating speed	5,500 rpm	12,000 rpm	5,500 rpm	12,000 rpm	5,500 rpm	12,000 rpm
Rotor position encoder, temperature range	-40 ... 105 °C					
MTTF, subcomponent <sup>1)</sup>	687 years, rotor position encoder	20 years, rotor position encoder	687 years, rotor position encoder	20 years, rotor position encoder	687 years, rotor position encoder	20 years, rotor position encoder

1) The data given applies to an encoder temperature/operating temperature of 40 °C.

Datasheet

**Total output moment of inertia - EMMB-ST-42**

Flange size, motors [mm]	42											
Length	[S]						[L]					
Measuring unit	[ ]		[M]		[S]		[ ]		[M]		[S]	
Brake	[ ]	[B]	[ ]	[B]	[ ]	[B]	[ ]	[B]	[ ]	[B]	[ ]	[B]
Total output moment of inertia	0.035 kgcm <sup>2</sup>	0.041 kgcm <sup>2</sup>	0.037 kgcm <sup>2</sup>	0.043 kgcm <sup>2</sup>	0.035 kgcm <sup>2</sup>	0.041 kgcm <sup>2</sup>	0.082 kgcm <sup>2</sup>	0.088 kgcm <sup>2</sup>	0.084 kgcm <sup>2</sup>	0.09 kgcm <sup>2</sup>	0.082 kgcm <sup>2</sup>	0.088 kgcm <sup>2</sup>

**Total output moment of inertia - EMMB-ST-57**

Flange size, motors [mm]	57											
Length	[M]						[L]					
Measuring unit	[ ]		[M]		[S]		[ ]		[M]		[S]	
Brake	[ ]	[B]	[ ]	[B]	[ ]	[B]	[ ]	[B]	[ ]	[B]	[ ]	[B]
Total output moment of inertia	0.3 kgcm <sup>2</sup>	0.324 kgcm <sup>2</sup>	0.306 kgcm <sup>2</sup>	0.33 kgcm <sup>2</sup>	0.3 kgcm <sup>2</sup>	0.324 kgcm <sup>2</sup>	0.48 kgcm <sup>2</sup>	0.504 kgcm <sup>2</sup>	0.486 kgcm <sup>2</sup>	0.51 kgcm <sup>2</sup>	0.48 kgcm <sup>2</sup>	0.504 kgcm <sup>2</sup>

**Total output moment of inertia - EMMB-ST-87**

Flange size, motors [mm]	87											
Length	[S]						[M]					
Measuring unit	[ ]		[M]		[S]		[ ]		[M]		[S]	
Brake	[ ]	[B]	[ ]	[B]	[ ]	[B]	[ ]	[B]	[ ]	[B]	[ ]	[B]
Total output moment of inertia	1 kgcm <sup>2</sup>	1.11 kgcm <sup>2</sup>	1.006 kgcm <sup>2</sup>	1.116 kgcm <sup>2</sup>	1 kgcm <sup>2</sup>	1.11 kgcm <sup>2</sup>	1.9 kgcm <sup>2</sup>	2.01 kgcm <sup>2</sup>	1.906 kgcm <sup>2</sup>	2.016 kgcm <sup>2</sup>	1.9 kgcm <sup>2</sup>	2.01 kgcm <sup>2</sup>

**Weight**

Flange size, motors [mm]	42				57				87			
Length	[S]		[L]		[M]		[L]		[S]		[M]	
Brake	[ ]	[B]	[ ]	[B]	[ ]	[B]	[ ]	[B]	[ ]	[B]	[ ]	[B]
Product weight	300 g	520 g	490 g	700 g	810 g	1,220 g	1,170 g	1,580 g	1,890 g	2,720 g	3,320 g	4,150 g



## Datasheet

Operating and environmental conditions						
Flange size, motors [mm]	42		57		87	
Length	[S]	[L]	[M]	[L]	[S]	[M]
Conforms to standard	IEC 60034					
Motor type to EN 60034-7	IM B5, IM V1, IM V3					
Degree of protection	IP20					
Note on degree of protection	IP40 for motor shaft without radial shaft seal					
Ambient temperature	0 ... 40 °C		-15 ... 40 °C			
Note on ambient temperature	Up to 80 °C with derating -2%/°C					
Storage temperature	-20 ... 70 °C					
Max. winding temperature	130 °C					
Temperature monitoring <sup>1)</sup>	Digital Motor temp. via BiSS-C					
Rating class according to EN 60034-1	S1					
Thermal class according to EN 60034-1	B					
Relative humidity	0 - 90%					
CE marking (see declaration of conformity) <sup>2)</sup>	To EU EMC Directive To EU RoHS Directive					
UKCA marking (see declaration of conformity) <sup>3)</sup>	To UK EMC regulations To UK RoHS regulations					
Certification	RCM					
Vibration resistant	Transport application test with severity level 2 to FN 942017-4 and EN 60068-2-6					
Shock resistance	Shock test with severity level 2 to FN 942017-5 and EN 60068-2-27					
Isolation resistance AC	0.6					
Electrical connection 1, connection type	Hybrid plug					
LABS (PWIS) conformity	VDMA24364 zone III					
Note on materials	RoHS-compliant					

1) Only possible with EMMB-ST-...-M (multiturn).

2) More information [www.festo.com/catalogue/emmb-st](http://www.festo.com/catalogue/emmb-st) → Support/Downloads.

3) More information [www.festo.com/catalogue/emmb-st](http://www.festo.com/catalogue/emmb-st) → Support/Downloads.

Datasheet

Torque M as a function of rotational speed n

EMMB-ST-42-S

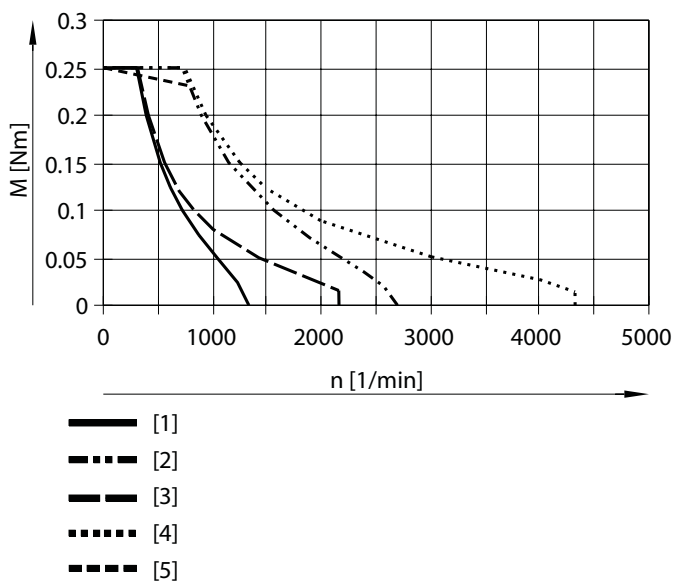

- [1] Peak torque at 24V DC
- [2] Peak torque at 48V DC
- [3] Field weakened peak torque at 24V DC
- [4] Field weakened peak torque at 48V DC
- [5] Nominal torque

Typical motor characteristic curve with nominal voltage and optimal motor controller.

Observe the maximum permissible rotational speed of add-on and installation components (such as encoder, brake etc.)!

EMMB-ST-42-L

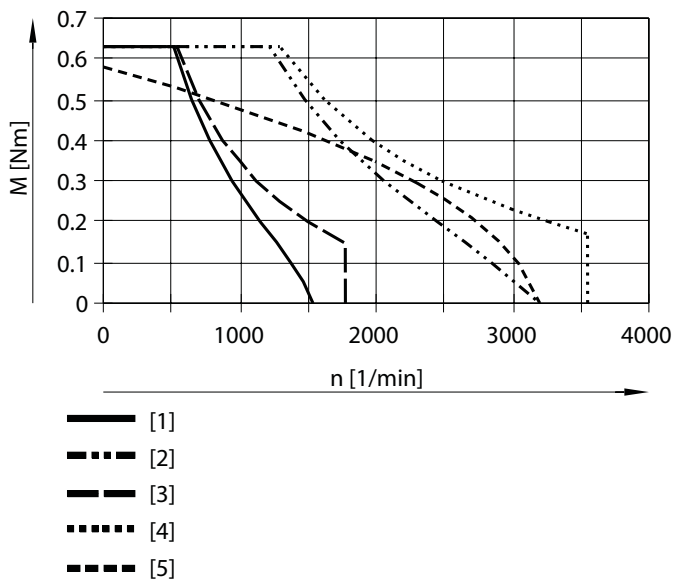

- [1] Peak torque at 24V DC
- [2] Peak torque at 48V DC
- [3] Field weakened peak torque at 24V DC
- [4] Field weakened peak torque at 48V DC
- [5] Nominal torque

Typical motor characteristic curve with nominal voltage and optimal motor controller.

Observe the maximum permissible rotational speed of add-on and installation components (such as encoder, brake etc.)!

Datasheet

Torque M as a function of rotational speed n

EMMB-ST-57-M

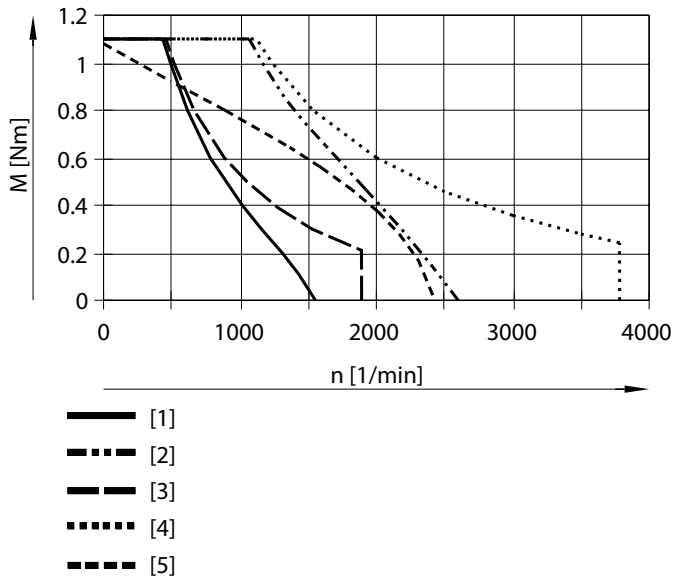

- [1] Peak torque at 24V DC
- [2] Peak torque at 48V DC
- [3] Field weakened peak torque at 24V DC
- [4] Field weakened peak torque at 48V DC
- [5] Nominal torque

Typical motor characteristic curve with nominal voltage and optimal motor controller.  
Observe the maximum permissible rotational speed of add-on and installation components (such as encoder, brake etc.)!

EMMB-ST-57-L

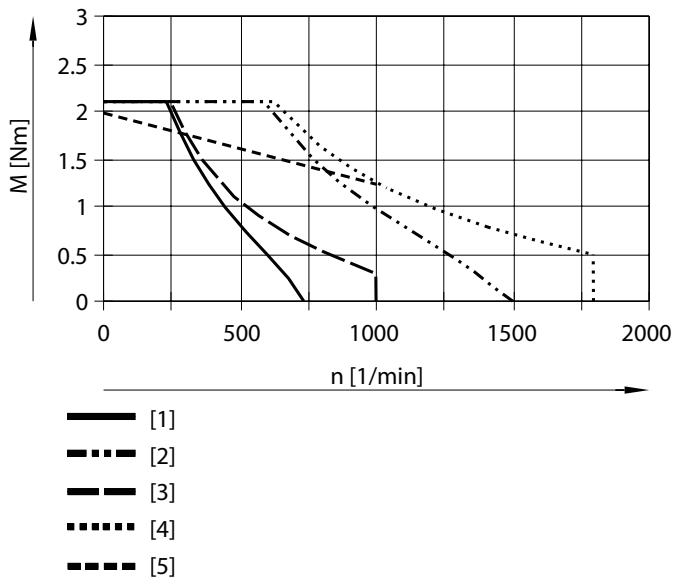

- [1] Peak torque at 24V DC
- [2] Peak torque at 48V DC
- [3] Field weakened peak torque at 24V DC
- [4] Field weakened peak torque at 48V DC
- [5] Nominal torque

Typical motor characteristic curve with nominal voltage and optimal motor controller.  
Observe the maximum permissible rotational speed of add-on and installation components (such as encoder, brake etc.)!

Datasheet

Torque M as a function of rotational speed n

EMMB-ST-87-S

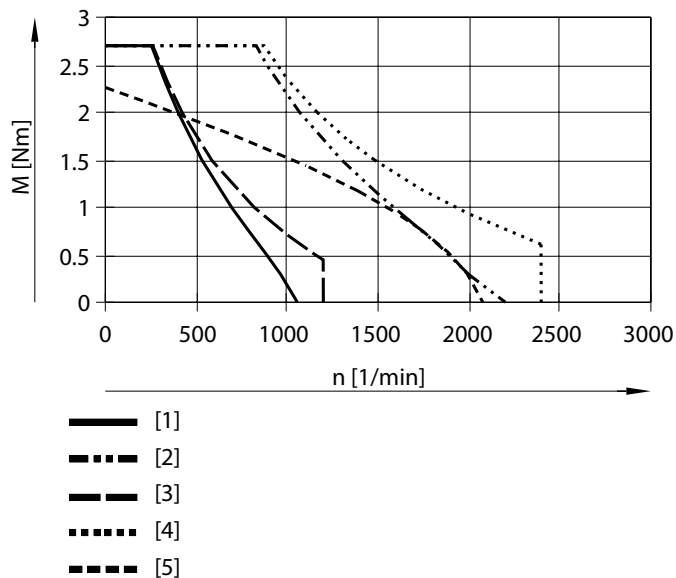

- [1] Peak torque at 24V DC
- [2] Peak torque at 48V DC
- [3] Field weakened peak torque at 24V DC
- [4] Field weakened peak torque at 48V DC
- [5] Nominal torque

Typical motor characteristic curve with nominal voltage and optimal motor controller.  
Observe the maximum permissible rotational speed of add-on and installation components (such as encoder, brake etc.)!

EMMB-ST-87-M

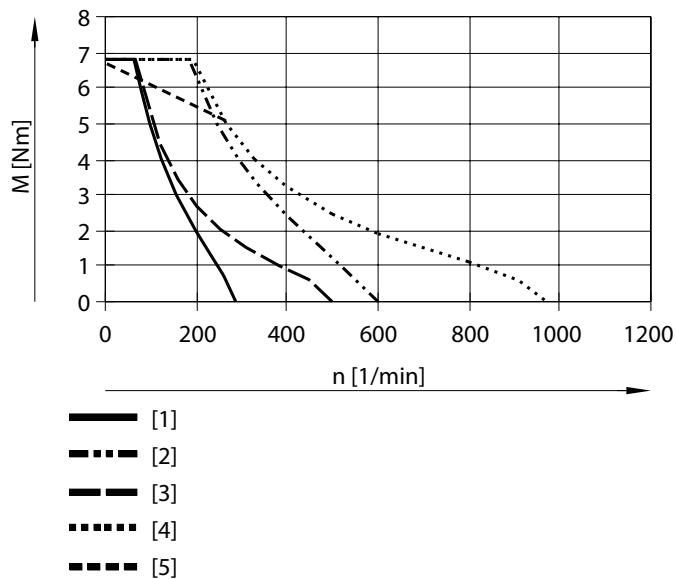

- [1] Peak torque at 24V DC
- [2] Peak torque at 48V DC
- [3] Field weakened peak torque at 24V DC
- [4] Field weakened peak torque at 48V DC
- [5] Nominal torque

Typical motor characteristic curve with nominal voltage and optimal motor controller.  
Observe the maximum permissible rotational speed of add-on and installation components (such as encoder, brake etc.)!

Datasheet

Dimensions – EMMB-ST-42/-57/-87

Download CAD data → [www.festo.com](http://www.festo.com)

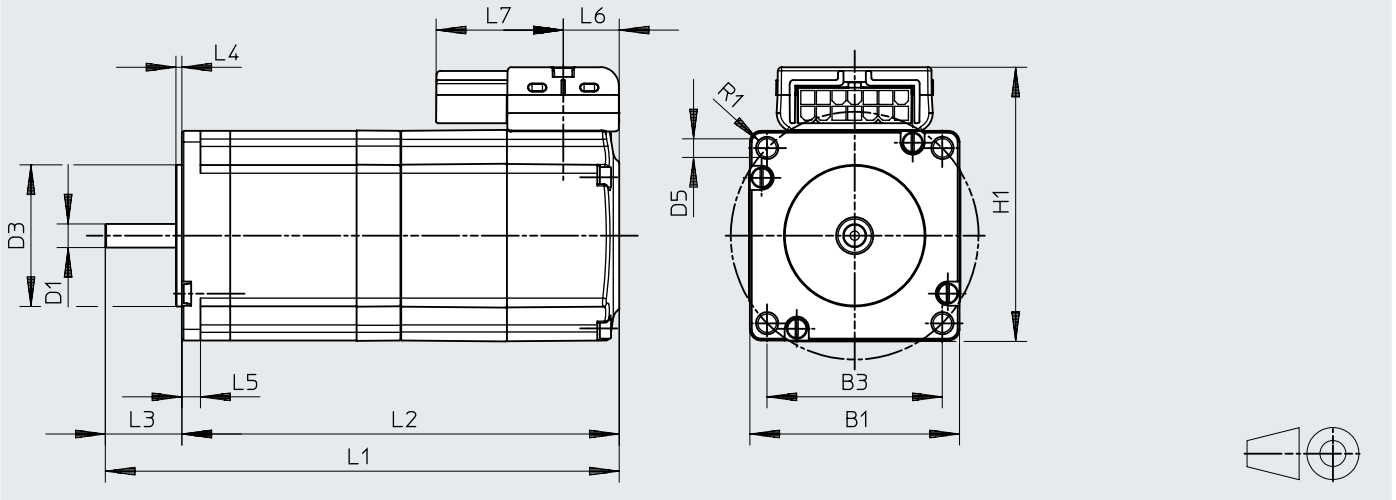

		B1	B3	D1	D3	D5	H1
			±0.2	∅ h6	∅ h8		
EMMB-ST-42	S	42	31	5	22	M3	55
	S-B						
	L						
	L-B						
EMMB-ST-57	M	56.4	47.1	6.35	38.1	5	75
	M-B						
	L						
	L-B						
EMMB-ST-87	S	85.9	69.5	11	73	6.6	75
	S-B						
	M						
	M-B						

		L1	L2	L3	L4	L5	L6	L7	R1
			±2	±0.5	±0.2				
EMMB-ST-42	S	94	70	24	2	-	15	25.6	2.3
	S-B	124	100						
	L	112	88						
	L-B	142	118						
EMMB-ST-57	M	108.3	88	20.6	1.6	5	15.1	34.2	3
	M-B	138.3	118						
	L	129.3	109						
	L-B	159.3	139						
EMMB-ST-87	S	120.7	93.7	27	2	8	15.1	34.2	5.5
	S-B	149.2	122.2						
	M	154.2	127.2						
	M-B	182.7	155.7						

## Ordering data

Ordering data Length	Measuring unit	Brake	Part no.	Type
<b>EMMB-ST-42</b>				
Short [S]	None	None	8156125	EMMB-ST-42-S-S
	Absolute encoder, single-turn [S]		8156126	EMMB-ST-42-S-SS
	Absolute encoder, multi-turn [M]		8156127	EMMB-ST-42-S-SM
	None	With brake [B]	8156128	EMMB-ST-42-S-SB
	Absolute encoder, single-turn [S]		8156129	EMMB-ST-42-S-SSB
	Absolute encoder, multi-turn [M]		8156130	EMMB-ST-42-S-SMB
Long [L]	None	None	8156131	EMMB-ST-42-L-S
	Absolute encoder, single-turn [S]		8156132	EMMB-ST-42-L-SS
	Absolute encoder, multi-turn [M]		8156133	EMMB-ST-42-L-SM
	None	With brake [B]	8156134	EMMB-ST-42-L-SB
	Absolute encoder, single-turn [S]		8156135	EMMB-ST-42-L-SSB
	Absolute encoder, multi-turn [M]		8156136	EMMB-ST-42-L-SMB
<b>EMMB-ST-57</b>				
Medium [M]	None	None	8156137	EMMB-ST-57-M-S
	Absolute encoder, single-turn [S]		8156138	EMMB-ST-57-M-SS
	Absolute encoder, multi-turn [M]		8156139	EMMB-ST-57-M-SM
	None	With brake [B]	8156140	EMMB-ST-57-M-SB
	Absolute encoder, single-turn [S]		8156141	EMMB-ST-57-M-SSB
	Absolute encoder, multi-turn [M]		8156142	EMMB-ST-57-M-SMB
Long [L]	None	None	8156143	EMMB-ST-57-L-S
	Absolute encoder, single-turn [S]		8156144	EMMB-ST-57-L-SS
	Absolute encoder, multi-turn [M]		8156145	EMMB-ST-57-L-SM
	None	With brake [B]	8156146	EMMB-ST-57-L-SB
	Absolute encoder, single-turn [S]		8156147	EMMB-ST-57-L-SSB
	Absolute encoder, multi-turn [M]		8156148	EMMB-ST-57-L-SMB
<b>EMMB-ST-87</b>				
Short [S]	None	None	8156149	EMMB-ST-87-S-S
	Absolute encoder, single-turn [S]		8156150	EMMB-ST-87-S-SS
	Absolute encoder, multi-turn [M]		8156151	EMMB-ST-87-S-SM
	None	With brake [B]	8156152	EMMB-ST-87-S-SB
	Absolute encoder, single-turn [S]		8156153	EMMB-ST-87-S-SSB
	Absolute encoder, multi-turn [M]		8156154	EMMB-ST-87-S-SMB
Medium [M]	None	None	8156155	EMMB-ST-87-M-S
	Absolute encoder, single-turn [S]		8156156	EMMB-ST-87-M-SS
	Absolute encoder, multi-turn [M]		8156157	EMMB-ST-87-M-SM
	None	With brake [B]	8156158	EMMB-ST-87-M-SB
	Absolute encoder, single-turn [S]		8156159	EMMB-ST-87-M-SSB
	Absolute encoder, multi-turn [M]		8156160	EMMB-ST-87-M-SMB

## Accessories

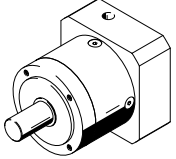
Planetary gear for EMMB-ST-42		Datasheets → Internet: emga		
	Gear ratio	Product weight	Part no.	Type
	3:1	350 g	☆ 549428	EMGA-40-P-G3-SST-42
	5:1	350 g	☆ 549429	EMGA-40-P-G5-SST-42
	8:1	400 g	8141762	EMGA-40-P-G8-SST-42
	12:1	450 g	8141763	EMGA-40-P-G12-SST-42

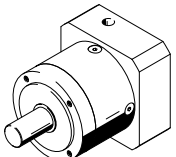
Planetary gear for EMMB-ST-57		Datasheets → Internet: emga		
	Gear ratio	Product weight	Part no.	Type
	3:1	900 g	☆ 549430	EMGA-60-P-G3-SST-57
	5:1	900 g	☆ 549431	EMGA-60-P-G5-SST-57
	8:1	900 g	8141764	EMGA-60-P-G8-SST-57
	12:1	1100 g	8141765	EMGA-60-P-G12-SST-57

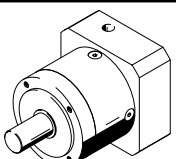
Planetary gear for EMMB-ST-87		Datasheets → Internet: emga		
	Gear ratio	Product weight	Part no.	Type
	3:1	2100 g	☆ 549432	EMGA-80-P-G3-SST-87
	5:1	2100 g	☆ 549433	EMGA-80-P-G5-SST-87
	8:1	2100 g	8141766	EMGA-80-P-G8-SST-87
	12:1	2600 g	8141767	EMGA-80-P-G12-SST-87

Accessories

**Recommended cable cross section as a function of cable length and servo drive CMMT-ST**

	Up to 5 m	Up to 10 m	Up to 20 m	Up to 25 m
EMMB-ST-42-S-...	Q6	Q6	Q6	Q6
EMMB-ST-42-L-...	Q6	Q6	Q6	Q6
EMMB-ST-57-M-...	Q6	Q7	Q9	Q9
EMMB-ST-57-L-...	Q6	Q7	Q9	Q9
EMMB-ST-87-S-...	Q7	Q9	Q9	Q9
EMMB-ST-87-M-...	Q7	Q9	Q9	Q9

- Q6 = 0.5 mm<sup>2</sup>
- Q7 = 0.75 mm<sup>2</sup>
- Q9 = 1.5 mm<sup>2</sup>

**Ordering data – Motor cable for EMMB-ST-42**

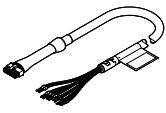
	Cable cross section <sup>1)</sup>	Bending radius, flexible cable installation	Cable characteristic	Cable length	Part no.	Type
	0.5 mm <sup>2</sup>	78.75 mm	Suitable for energy chains	2.5 m	<b>8181675</b>	<b>NEBM-L5G14-EH-2.5-Q6N-LE12</b>
				5 m	<b>8181664</b>	<b>NEBM-L5G14-EH-5-Q6N-LE12</b>
				7.5 m	<b>8181676</b>	<b>NEBM-L5G14-EH-7.5-Q6N-LE12</b>
				10 m	<b>8181672</b>	<b>NEBM-L5G14-EH-10-Q6N-LE12</b>
	0.5 ... 1.5 mm <sup>2</sup>	78.75 ... 81 mm	Suitable for energy chains	0.5 ... 25 m	<b>8181663</b>	<b>NEBM-LX/M17-</b>

1) For NEBM-LX/M17-...: selectable cable length: 0.5 ... 25 m, in 0.5 m grid and all cable cross-sections Q6, Q7, Q9

**Ordering data – Motor cable for EMMB-ST-57/87**

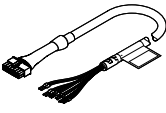
	Cable cross section <sup>1)</sup>	Bending radius, flexible cable installation	Cable characteristic	Cable length	Part no.	Type
	0.5 mm <sup>2</sup>	78.75 mm	Suitable for energy chains	2.5 m	<b>8181677</b>	<b>NEBM-L10G14-EH-2.5-Q6N-LE12</b>
				5 m	<b>8181667</b>	<b>NEBM-L10G14-EH-5-Q6N-LE12</b>
				7.5 m	<b>8181669</b>	<b>NEBM-L10G14-EH-7.5-Q6N-LE12</b>
				10 m	<b>8181665</b>	<b>NEBM-L10G14-EH-10-Q6N-LE12</b>
	0.75 mm <sup>2</sup>	78.75 mm	Suitable for energy chains	2.5 m	<b>8181666</b>	<b>NEBM-L10G14-EH-2.5-Q7N-LE12</b>
				5 m	<b>8181671</b>	<b>NEBM-L10G14-EH-5-Q7N-LE12</b>
				7.5 m	<b>8181674</b>	<b>NEBM-L10G14-EH-7.5-Q7N-LE12</b>
				10 m	<b>8181673</b>	<b>NEBM-L10G14-EH-10-Q7N-LE12</b>
	0.5 ... 1.5 mm <sup>2</sup>	78.75 ... 81 mm	Suitable for energy chains	0.5 ... 25 m	<b>8181663</b>	<b>NEBM-LX/M17-</b>

1) For NEBM-LX/M17-...: selectable cable length: 0.5 ... 25 m, in 0.5 m grid and all cable cross-sections Q6, Q7, Q9