

## Servo motor EMMB-AS

**FESTO**

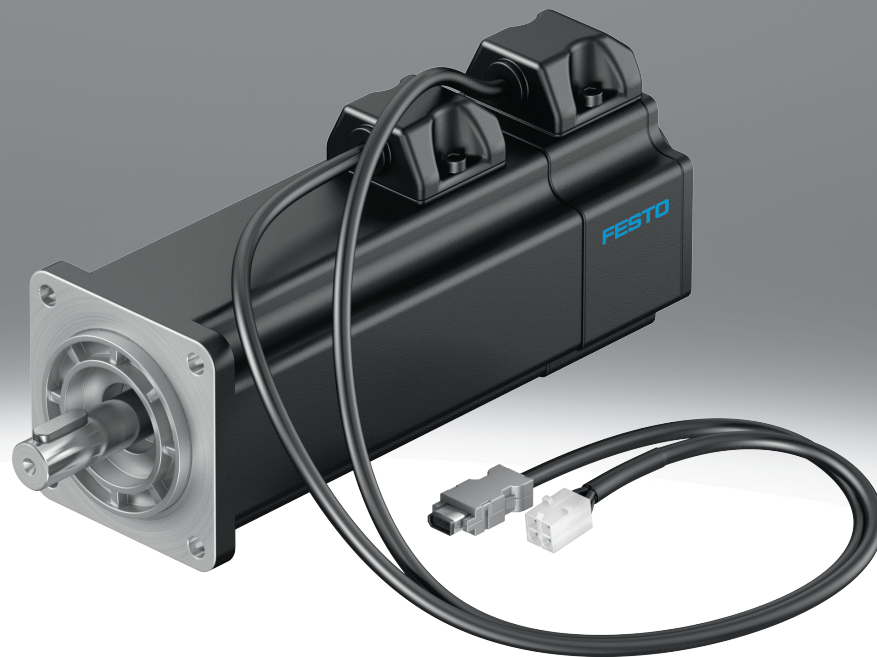

## Characteristics

### At a glance

- Dynamic, brushless, permanently excited synchronous servo motors
- Reliable, dynamic, precise

Digital absolute encoder system:

- Single turn
- Multi-turn

Winding variants:

- Rotational speed optimised
- For single-phase motor controllers

Degree of protection:

- IP40 (motor shaft)
- IP54 (motor shaft with rotary shaft seal)
- IP65 (motor housing without connection technology)

(The rotary shaft seal is included in the scope of delivery of the motor)

Optional:

- Shaft with feather key
- Holding brake

### Engineering tools

[Link ↗ electric motion sizing](#)



Save time with engineering tools: Smart engineering for the optimal solution. Our goal is to increase your productivity. Our engineering tools play an integral part in achieving this goal. They help you size your system correctly, tap into unimagined productivity reserves and generate additional productivity along the entire value chain. In every phase of your project, from the initial contact to the modernisation of your machine, you will come across a number of different tools that will be of use to you.

### Diagrams

[Link ↗ emmb-as](#)



The diagrams shown in this document are also available online. These can be used to display precise values.

### Measuring unit

[S]	Absolute encoder, single turn	[M]	Absolute encoder, multi-turn
The angular position is assigned to a unique value in coded form.		A unique value in coded form is assigned to the angular position and each full turn.	
<ul style="list-style-type: none"> <li>• The position is only detected within one turn. All subsequent turns need to be counted by the higher-level device.</li> <li>• When switched off, the position is only sensed within one turn.</li> <li>• Following switch-on, a homing run is required.</li> </ul>		<ul style="list-style-type: none"> <li>• This type counts the full turns until the specified maximum is reached (including when switched off).</li> <li>• Homing is only required once it has been installed in the application.</li> </ul>	

### Brake

The holding brake should not be used as a safety brake.

## Type code

<b>001</b>	Series	
<b>EMMB</b>	Motor	
<b>002</b>	Motor type	
<b>AS</b>	AC synchronous	
<b>003</b>	Flange size, motors [mm]	
<b>40</b>	40	
<b>60</b>	60	
<b>80</b>	80	
<b>004</b>	Performance class	
<b>01</b>	100 W	
<b>02</b>	200 W	
<b>04</b>	400 W	
<b>07</b>	750 W	

<b>005</b>	Output shaft	
	Smooth shaft	
<b>K</b>	Shaft to DIN 6885	
<b>006</b>	Electrical connection	
<b>S</b>	Straight plug	
<b>007</b>	Cable length [cm]	
<b>30</b>	30 cm	
<b>008</b>	Measuring unit	
<b>M</b>	Absolute encoder, multi-turn	
<b>S</b>	Absolute encoder, single turn	
<b>009</b>	Brake	
	None	
<b>B</b>	With brake	

## Datasheet

### General technical data

Flange size, motors [mm]	40	60	80
Performance class	100 W [01]	200 W [02]	400 W [04] 750 W [07]
Nominal operating voltage DC	300 V		
Nominal motor current	1.3 A	1.4 A	2.4 A 3.8 A
Continuous stall current	1.43 A	1.5 A	2.6 A 4.2 A
Peak current	3.9 A	4.2 A	7.2 A 11.4 A
Nominal power rating of motor	100 W	200 W	400 W 750 W
Nominal torque	0.32 Nm	0.64 Nm	1.27 Nm 2.39 Nm
Peak torque	0.96 Nm	1.92 Nm	3.81 Nm 7.17 Nm
Standstill torque	0.352 Nm	0.7 Nm	1.4 Nm 2.63 Nm
Nominal rotary speed	3,000 rpm		
Max. rotational speed	6,000 rpm		5,000 rpm
Motor constant	0.268 Nm/A	0.48 Nm/A	0.562 Nm/A 0.662 Nm/A
Voltage constant, phase-to-phase	16.2 mV/min	29 mV/min	34 mV/min 40 mV/min
Number of pole pairs	5	3	
Phase-phase winding resistance	7.9 Ohm	11.2 Ohm	5.8 Ohm 2.1 Ohm
Phase-phase winding inductance	10.5 mH	20.9 mH	11.5 mH 10.5 mH
Total mass moment of inertia of output <sup>1)</sup>	0.059 kgcm <sup>2</sup> ; 0.063 kgcm <sup>2</sup>	0.214 kgcm <sup>2</sup> ; 0.234 kgcm <sup>2</sup>	0.405 kgcm <sup>2</sup> ; 0.425 kgcm <sup>2</sup> 0.942 kgcm <sup>2</sup> ; 0.978 kgcm <sup>2</sup>
Permissible axial shaft load	60 N	90 N	167.5 N
Permissible radial shaft load	120 N	180 N	335 N

1) Without brake/with brake

### Technical data Brakes

Flange size, motors [mm]	40	60	80
Performance class	100 W [01]	200 W [02]	400 W [04] 750 W [07]
Operating voltage DC for brake	24 V		
Power consumption, brake	5.9 W	7.2 W	11.5 W
Brake holding torque	0.32 Nm	1.3 Nm	3.2 Nm

### Technical data – Encoder

Rotor position sensor	Absolute single-turn encoder	Absolute multi-turn encoder
Rotor position encoder interface	Nikon A-format	
rotor position sensor, DC operating voltage	5 V	
rotor position sensor, DC operating voltage range	4.75 ... 5.25 V	
Rotor position sensor, encoder measuring principle	Optical	
rotor position sensor, max. operating speed	6,000 rpm	
rotor position sensor, position values per revolution	1,048,576	
rotor position sensor, absolute detectable revolutions	1	65,536
Rotor position transducer resolution	20 bit	
rotor position sensor, system accuracy of angle measurement	-120 ... 120 arcsec	
rotor position sensor, temperature range	-20 ... 95°C	

## Datasheet

Operating and environmental conditions	
Flange size, motors [mm]	40   60   80
Conforms to standard	IEC 60034
Motor type to EN 60034-7	IM B5, IM V1, IM V3
Degree of protection	IP65
Note on degree of protection <sup>1)</sup>	IP40 for motor shaft without rotary shaft seal IP54 for motor shaft with rotary shaft seal IP65 for motor housing without connection technology
Ambient temperature	-15 ... 40°C
Note on ambient temperature	Up to 60°C with derating of -1.5% per degree Celsius
Storage temperature	-20 ... 55°C
Max. winding temperature	155°C
Insulation protection class	–
Temperature monitoring	Digital motor temperature transmission via Nikon A format
Rating class as per EN 60034-1	S1
Temperature class as per EN 60034-1	F
Relative air humidity	0 - 90%
Concentricity, coaxiality, axial runout to DIN SPEC 42955	N
Balance quality	G 2.5
Pollution degree	2
Max. installation height	4,000 m
Note on max. installation height	As of 1,000 m: only with derating of -1.0% per 100 m
Bearing lifetime under nominal conditions	20,000 h
CE mark (see declaration of conformity) <sup>2)</sup>	To EU EMC Directive To EU Low Voltage Directive In accordance with EU RoHS Directive
UKCA marking (see declaration of conformity) <sup>3)</sup>	To UK instructions for EMC To UK RoHS instructions To UK regulations for electrical equipment
Approval	c UL us - Recognized (OL)
Certificate issuing authority	UL E342973
Vibration resistance	Transport application test with severity level 2 to FN 942017-4 and EN 60068-2-6
Shock resistance	Shock test with severity level 2 to FN 942017-5 and EN 60068-2-27
LABS (PWIS) conformity	VDMA24364 zone III
Note on materials	RoHS-compliant

1) The rotary shaft seal is included in the scope of delivery of the motor.

2) More information [www.festo.com/catalogue/emmb](http://www.festo.com/catalogue/emmb) → Support/Downloads

3) More information [www.festo.com/catalogue/emmb](http://www.festo.com/catalogue/emmb) → Support/Downloads

Weight				
Flange size, motors [mm]	40	60		80
Performance class	100 W [01]	200 W [02]	400 W [04]	750 W [07]
Product weight <sup>1)</sup>	570 g; 770 g	1,100 g; 1,400 g	1,600 g; 1,900 g	2,800 g; 3,400 g

1) Without brake/with brake

## Datasheet

Torque M as a function of rotational speed n for EMMB-AS-40

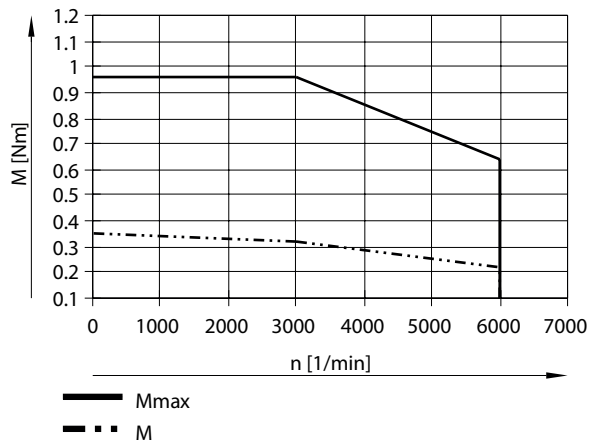

Typical motor characteristic curve with nominal voltage and optimal motor controller.

Torque M as a function of rotational speed n for EMMB-AS-60-02

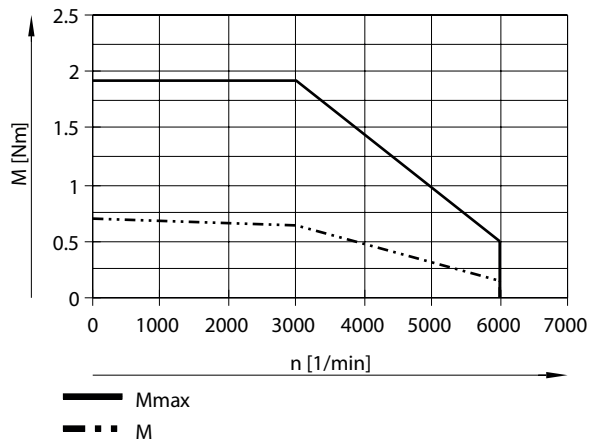

Typical motor characteristic curve with nominal voltage and optimal motor controller.

Torque M as a function of rotational speed n for EMMB-AS-60-04

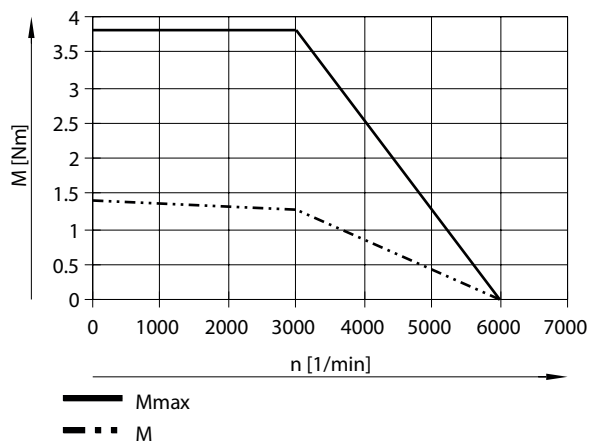

Typical motor characteristic curve with nominal voltage and optimal motor controller.

## Datasheet

## Torque M as a function of rotational speed n for EMMB-AS-80

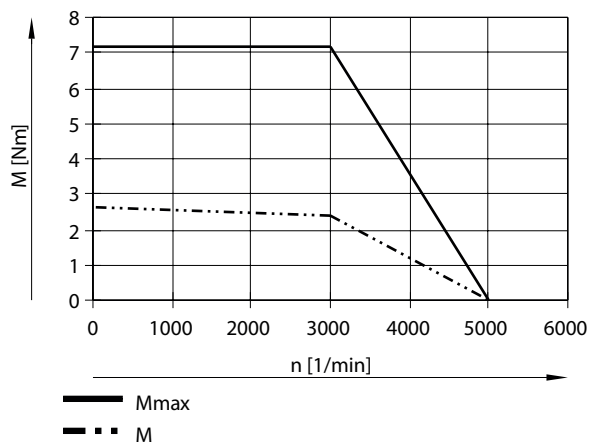

Typical motor characteristic curve with nominal voltage and optimal motor controller.

## Dimensions

### Dimensions – EMMB-AS-40

Download CAD data [www.festo.com](http://www.festo.com)

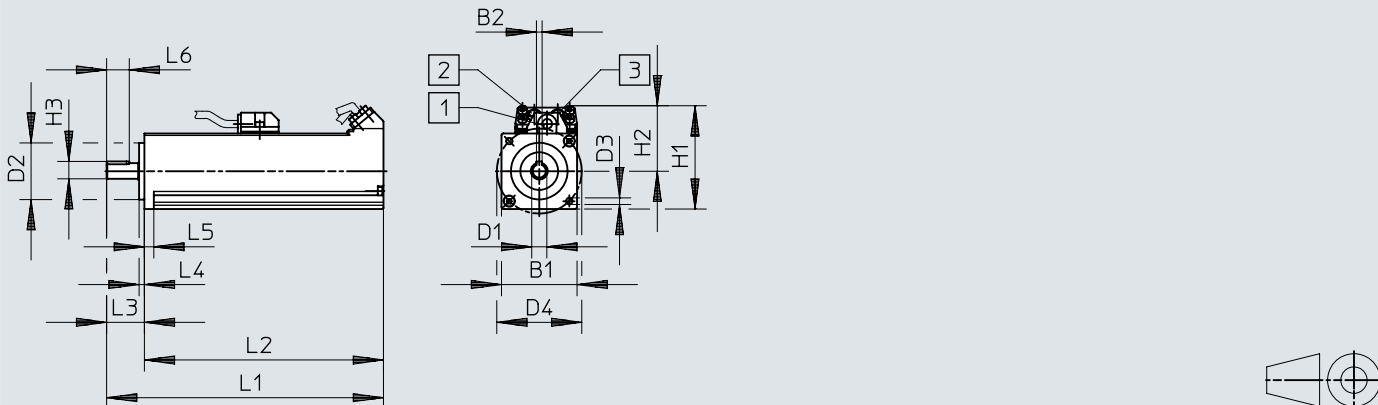

- [1] Electrical connection for motor
- [2] Electrical connection for brake
- [3] Electrical connection for encoder

	B1	B2	D1 ∅	D2 ∅	D3 ∅	D4 ∅
		-0,014	-0,013	-0,021		±0,2
EMMB-AS-40-...	40	-	8	30	3,5	45
EMMB-AS-40-...-K		3				

	H1 max.	H2 max.	H3	L1		L2	
				1) +1,5/-1,7	2) +1,5/-1,7	1) ±1	2) ±1
EMMB-AS-40-...	70	50	-	116,6	146,6	96,6	126,6
EMMB-AS-40-...-K			9,7				

	L3	L4	L5	L6
	+0,5/-0,7			
EMMB-AS-40-...	20	2,8	5	-
EMMB-AS-40-...-K				12

- 1) Without brake
- 2) With brake



## Dimensions

Dimensions – EMMB-AS-60/-80

Download CAD data [www.festo.com](http://www.festo.com)

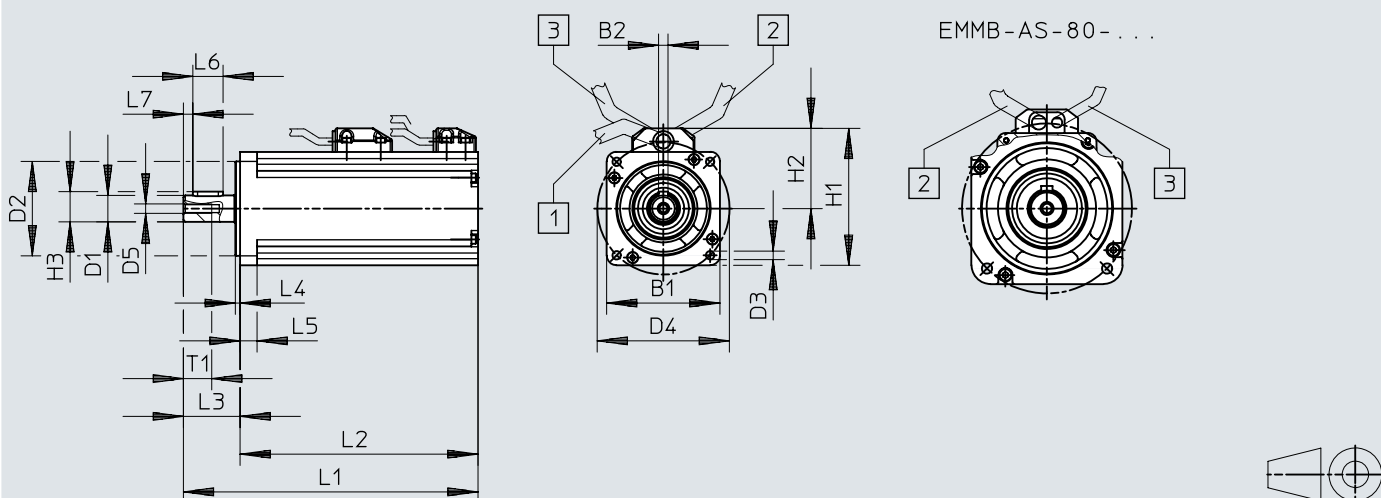

- [1] Electrical connection for motor
- [2] Electrical connection for encoder
- [3] Electrical connection for brake

	B1	B2	D1 ∅	D2 ∅	D3 ∅	D4 ∅ ±0,1	D5 ∅
EMMB-AS-60-02-...	60	–	14 <sub>-0,011</sub>	50 <sub>-0,016</sub>	4,5	70	5
EMMB-AS-60-02-...-K		5					
EMMB-AS-60-04-...	60	–	14 <sub>-0,011</sub>	50 <sub>-0,016</sub>	4,5	70	5
EMMB-AS-60-04-...-K		5					
EMMB-AS-80-07-...	80	–	19 <sub>-0,013</sub>	70 <sub>-0,02</sub>	5,5	90	6
EMMB-AS-80-07-...-K		6					

	H1	H2	H3 –0,13	L1		L2	
				1) ±1,5	2) ±1,5	1) ±1,5	2) ±1,5
EMMB-AS-60-02-...	72,5	42,5	16	124 <sub>±2,5</sub>	156 <sub>±2,5</sub>	94	126
EMMB-AS-60-02-...-K							
EMMB-AS-60-04-...	72,5	42,5	16	150 <sub>±2,5</sub>	182 <sub>±2,5</sub>	120	152
EMMB-AS-60-04-...-K							
EMMB-AS-80-07-...	94	54	21,5	164 <sub>±2,4/-2</sub>	193,5 <sub>±2,4/-2</sub>	129,5	159
EMMB-AS-80-07-...-K							

	L3	L4	L5 ±1	L6	L7	T1
EMMB-AS-60-02-...	30 <sub>±1</sub>	2,5	9	–	–	15
EMMB-AS-60-02-...-K				16	5	
EMMB-AS-60-04-...	30 <sub>±1</sub>	2,5	9	–	–	15
EMMB-AS-60-04-...-K				16	5	
EMMB-AS-80-07-...	34,5 <sub>+0,9/-0,5</sub>	3	10	–	–	15
EMMB-AS-80-07-...-K				22	4	

- 1) Without brake
- 2) With brake

## Ordering data

Flange size 40					
Performance class	Measuring unit	Output shaft	Brake	Part no.	Type
100 W	Absolute encoder, multi-turn	Shaft to DIN 6885	None	8097169	EMMB-AS-40-01-K-S30M
		Smooth shaft		8097167	EMMB-AS-40-01-S30M
		Shaft to DIN 6885	With brake	8097168	EMMB-AS-40-01-S30MB
			None	8097170	EMMB-AS-40-01-K-S30MB
	Absolute encoder, single turn	Smooth shaft	None	8097165	EMMB-AS-40-01-K-S30S
				8097163	EMMB-AS-40-01-S30S
		Shaft to DIN 6885	With brake	8097166	EMMB-AS-40-01-K-S30SB
				8097164	EMMB-AS-40-01-S30SB

Flange size 60					
Performance class	Measuring unit	Output shaft	Brake	Part no.	Type
200 W	Absolute encoder, multi-turn	Smooth shaft	None	8097175	EMMB-AS-60-02-S30M
		Shaft to DIN 6885		8097177	EMMB-AS-60-02-K-S30M
		Smooth shaft	With brake	8097176	EMMB-AS-60-02-S30MB
			Shaft to DIN 6885	8097178	EMMB-AS-60-02-K-S30MB
	Absolute encoder, single turn	Smooth shaft	None	8097173	EMMB-AS-60-02-K-S30S
				8097171	EMMB-AS-60-02-S30S
		Shaft to DIN 6885	With brake	8097172	EMMB-AS-60-02-S30SB
				8097174	EMMB-AS-60-02-K-S30SB
400 W	Absolute encoder, multi-turn	Smooth shaft	None	8097185	EMMB-AS-60-04-K-S30M
				8097183	EMMB-AS-60-04-S30M
		Smooth shaft	With brake	8097184	EMMB-AS-60-04-S30MB
			Shaft to DIN 6885	None	8097181
	8097179	EMMB-AS-60-04-S30S			
	With brake	8097182		EMMB-AS-60-04-K-S30SB	
		8097180		EMMB-AS-60-04-S30SB	

Flange size 80					
Performance class	Measuring unit	Output shaft	Brake	Part no.	Type
750 W	Absolute encoder, multi-turn	Smooth shaft	None	8097191	EMMB-AS-80-07-S30M
		Shaft to DIN 6885		8097193	EMMB-AS-80-07-K-S30M
		Smooth shaft	With brake	8097194	EMMB-AS-80-07-K-S30MB
			None	8097192	EMMB-AS-80-07-S30MB
	Absolute encoder, single turn	Smooth shaft	None	8097187	EMMB-AS-80-07-S30S
				8097189	EMMB-AS-80-07-K-S30S
		Shaft to DIN 6885	With brake	8097188	EMMB-AS-80-07-S30SB
				8097190	EMMB-AS-80-07-K-S30SB

## Accessories

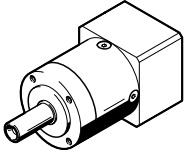
Planetary gear for EMMB-AS-40						
	Gear unit ratio	Note on materials	Product weight	Part no.	Type	
	3:1	RoHS-compliant	350 g	★ 2297684	EMGA-40-P-G3-EAS-40	
	5:1			★ 2297685	EMGA-40-P-G5-EAS-40	

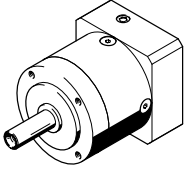
Planetary gear for EMMB-AS-60						
	Gear unit ratio	Note on materials	Product weight	Part no.	Type	
	3:1	RoHS-compliant	900 g	★ 2297686	EMGA-60-P-G3-EAS-60	
	5:1			★ 2297687	EMGA-60-P-G5-EAS-60	

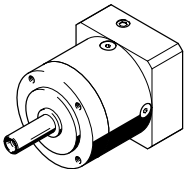
Planetary gear for EMMB-AS-80						
	Gear unit ratio	Note on materials	Product weight	Part no.	Type	
	3:1	RoHS-compliant	2,000 g	★ 2297690	EMGA-80-P-G3-EAS-80	
	5:1			★ 2297691	EMGA-80-P-G5-EAS-80	

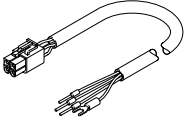
Motor cable						
	Bending radius, moving cable	Cable characteristic	Ambient temperature	Cable length	Part no.	Type
	55 mm	Suitable for energy chains	-25 ... 90 °C	2.5 m	★ 5219197	NEBM-H6G4-E-2.5-Q13N-LE4
				5 m	★ 5219198	NEBM-H6G4-E-5-Q13N-LE4
				7.5 m	★ 5219199	NEBM-H6G4-E-7.5-Q13N-LE4
				10 m	★ 5219200	NEBM-H6G4-E-10-Q13N-LE4
				15 m	★ 8097203	NEBM-H6G4-E-15-Q13N-LE4
				20 m	★ 8097204	NEBM-H6G4-E-20-Q13N-LE4
				25 m	★ 8097205	NEBM-H6G4-E-25-Q13N-LE4

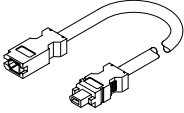
Encoder cable						
	Bending radius, moving cable	Cable characteristic	Ambient temperature	Cable length	Part no.	Type
	55 mm	Suitable for energy chains	-40 ... 80 °C	2.5 m	★ 5219213	NEBM-REG6-E-2.5-Q14N-REG6
				5 m	★ 5219214	NEBM-REG6-E-5-Q14N-REG6
				7.5 m	★ 5219215	NEBM-REG6-E-7.5-Q14N-REG6
				10 m	★ 5219216	NEBM-REG6-E-10-Q14N-REG6
				15 m	★ 8097200	NEBM-REG6-E-15-Q14N-REG6
				20 m	★ 8097201	NEBM-REG6-E-20-Q14N-REG6
				25 m	★ 8097202	NEBM-REG6-E-25-Q14N-REG6

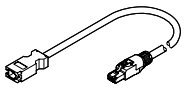
Adapter for encoder cable for single turn with CMMT-AS						
	Cable characteristic	Ambient temperature	Cable length <sup>1)</sup>	Part no.	Type	
	Standard	-40 ... 80 °C	0.5 m	8097197	NEFM-REG6-K-0.5-R3G8	

1) The adapter is mandatory.

## Accessories

### Adapter for encoder cable for multi-turn with CMMT-AS

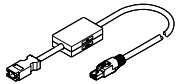
	Cable characteristic	Ambient temperature	Cable length <sup>1)</sup>	Part no.	Type
	Standard	-40 ... 80 °C	0.5 m	<b>8097195</b>	<b>NEFM-REG6-K-0.5-B-R3G8</b>

1) The adapter is definitely required. The required battery is not included in the scope of delivery.

### Adapter for encoder cable for multi-turn with CMMB-AS

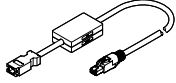
	Cable characteristic	Ambient temperature	Cable length <sup>1)</sup>	Part no.	Type
	Standard	-40 ... 80 °C	0.5 m	<b>8097196</b>	<b>NEFM-REG6-K-0.5-B-REG6</b>

1) The adapter is definitely required. The required battery is not included in the scope of delivery.

### Connecting cable for brake

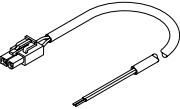
	Bending radius, moving cable	Cable characteristic	Ambient temperature	Cable length	Part no.	Type
	55 mm	Suitable for energy chains	-40 ... 80 °C	2.5 m	<b>5219205</b>	<b>NEBM-H7G2-E-2.5-Q14N-LE2</b>
				5 m	★ <b>5219206</b>	<b>NEBM-H7G2-E-5-Q14N-LE2</b>
				7.5 m	<b>5219207</b>	<b>NEBM-H7G2-E-7.5-Q14N-LE2</b>
				10 m	★ <b>5219208</b>	<b>NEBM-H7G2-E-10-Q14N-LE2</b>
				15 m	★ <b>8097206</b>	<b>NEBM-H7G2-E-15-Q14N-LE2</b>
				20 m	★ <b>8097207</b>	<b>NEBM-H7G2-E-20-Q14N-LE2</b>
				25 m	★ <b>8097208</b>	<b>NEBM-H7G2-E-25-Q14N-LE2</b>