

Servo drive CMMT-ST

FESTO



Characteristics

At a glance

Further information → [cmmt-st](#)

- Space-optimised servo drive for operating stepper motors and brushless DC motors
- For extremely economical positioning tasks and motion solutions with low power requirements up to 300 W and 800 W peak performance for 3 s
- Primary voltage from 24 ... 48 V DC
- Motor current 8 A (peak 20 A)
- 50% more compact than the smallest CMMT-AS
- Point-to-point and interpolating movements and precise positioning possible
- Direct fieldbus integration for controllers from the major manufacturers
- Auto-tuning supports easy commissioning of rotary and linear motion using mechanical systems from Festo and third-party suppliers

Product segmentation



Festo Core Range

Solves the majority of your automation tasks

With the Festo Core Range, we have selected the most important products and functions from our broad product catalogue, and added the quickest delivery. The Core Range offers you the best value with the expected high Festo quality.

- Quickest delivery, worldwide – wherever, whenever
- Expected high Festo quality
- Easy and fast to select

Engineering tools

Further information → [engineering tools](#)



Save time with engineering tools Smart Engineering for the optimal solution. Our goal is to increase your productivity. Our engineering tools play an integral part in this. They help you size your system correctly, tap into unimagined productivity reserves and generate additional productivity along the entire value chain. In every phase of your project, from the initial contact to the modernisation of your machine, you will come across a number of different tools which will be of use to you.

Electric Motion Sizing

- Create the optimum drive package quickly and reliably. Electric Motion Sizing calculates suitable combinations of electric axis, electric motor and servo drive using just a few application details. It provides all the relevant data including the bill of materials and documentation for your selected combination. This avoids design errors and results in significantly improved energy efficiency for the system. A smooth connection to the Festo Automation Suite also makes commissioning easier for you.

Festo Automation Suite

- Parameterisation, programming and commissioning in a clear and user-friendly interface
- Optimal support for complex processes thanks to guided wizards (e.g. for initial commissioning, drive configuration, etc.)
- Quick access to the required documents and further information
- Easy integration of electric drives in the controller programming

EPLAN

- EPLAN macros for fast and reliable electrical project planning in combination with servo drives, motors and cables. This allows a high level of planning reliability, consistency of documentation, with no need to create your own symbols, graphics and master data.

Trademarks

The following are the registered trademarks of the respective trademark owner in certain countries:

- PROFINET®
- EtherCat®
- EtherNet/IP®
- Modbus®

Characteristics

Bus protocol/activation

- Supported bus protocols: EtherCAT®; EtherNet/IP; PROFINET
- Modbus TCP is available as an additional protocol with all Ethernet/IP devices

[MP] Multiprotocol

EtherCAT®

EtherNet/IP®

PROFI
NET®

Modbus

Safety function

- Safe torque off (STO) up to SIL3/Cat. 3 PL e
- Safe stop 1 (SS1) when using a suitable external safety relay unit and suitable circuitry for the servo drive

Overview

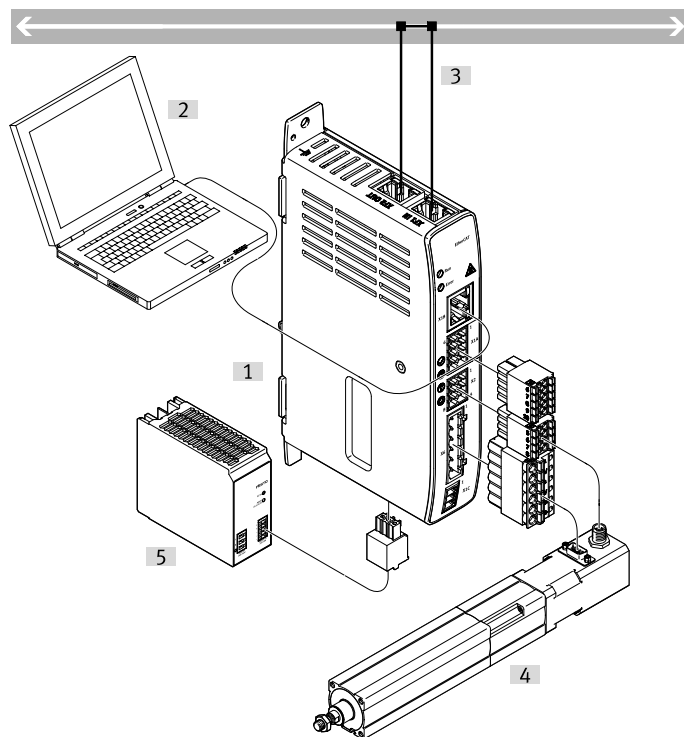

- [1] Servo drive
- [2] PC with Ethernet connection
- [3] Bus/network
- [4] Axis with motor
- [5] Power supply unit for logic and load supply

Type code

001	Series
CMMT	Motor controller

002	Motor type
ST	Stepper motor ST

003	Nominal current
C8	8 A

004	Nominal input voltage
1C	24 - 48 V DC

005	Bus protocol/activation
MP	Multiprotocol

006	Safety function
S0	Basic safety

Datasheet

General technical data	
Type of mounting	Mounting plate, attached with screws With H-rail
Display	Green/yellow/red LED
Controller operating mode	Cascade controller P position controller PI speed controller PI current regulator for F or M Profile operation with record and direct mode Interpolated mode via fieldbus Synchronised operating modes Homing Setting-up Autotuning Open-loop operation
Operating mode of drive unit	Field-oriented closed-loop control Position resolution 24 bit/rev Real-time data acquisition 2x input capture (x, v, F) 2x output trigger (x, v, F) 1x position encoder input Sampling rate 16 or 20 kHz PWM with 16 or 20 KHz
Adjustable current reduction	Via software
Protective function	I ² t monitoring Temperature monitoring Current monitoring Voltage failure detection Following error monitoring Software end-position detection
Mounting position	Free convection, Vertical
Product weight	350 g

Bus protocol	
Fieldbus link	EtherCAT, EtherNet/IP, Modbus/TCP, PROFINET
Fieldbus interface, function	Bus connection incoming/outgoing, EtherCAT® slave, PROFINET slave, Fieldbus
Process interfacing	I/O mode for 256 positioning records Interpolated mode CSP Interpolated mode CST Interpolated mode CSV
Communication profile	CiA402 CoE (CANopen over EtherCAT®) EoE (Ethernet over EtherCAT®) FoE (File over EtherCAT®) PROFIdrive
Field bus interface, transmission rate	100 Mbit/s
Field bus, connection type	2x socket
Field bus, connection system	RJ45

Datasheet

Electrical data

Output voltage class AC	0 V up to input voltage
Nominal output current	8 A
Nominal current per phase, effective	8 A
Peak current per phase, effective	20 A
Max. peak current duration	3 s
Controller nominal output	300 W
Maximum output	800 W
Output frequency	600 Hz
Max. length of motor cable without external mains filter	25 m
Load voltage range DC	24 V, 48 V
Max. intermediate circuit voltage DC	60 V
Nominal voltage for logic power supply DC	24 V
Current consumption of logic power supply without clamping brake	1 A
Current consumption for logic supply with parking brake	2 A
Max. output current of holding brake	1 A
Max. voltage drop from logic supply to brake output	1 V

Interfaces

Ethernet interface, function	Parameterisation and commissioning
Ethernet interface, protocol	TCP/IP
Encoder interface, function	BiSS-C Incremental encoder
Number of digital logic inputs	6
Number of high-speed logic inputs	2
Time resolution of high-speed logic inputs	1 µs
Features of digital logic outputs	Not galvanically isolated
Switching logic for inputs	PNP (positive switching)
Specification logic input	Based on IEC 61131-2, type 3
Working range of logic input	-3 ... 30 V
Number of high-speed switching outputs	2
Time resolution of high-speed switching outputs	1 µs
Switching logic for outputs	PNP (positive switching)
Max. current digital logic outputs	100 mA
Number of floating switching outputs	1
Max. current of the floating switching outputs	100 mA

Braking resistor

Brake resistor, external	6 Ohm
Max. continuous output of the external braking resistor (IEC)	490 W

Datasheet

Safety characteristics	
Safety function	Safe torque off (STO) Safe stop 1 time controlled (SS1-t)
Performance Level (PL)	STO/Cat. 3, PLd (EC motor without diagnostics) STO/Cat. 3, PLe (stepper motor/EC motor with diagnostics)
Safety Integrity Level (SIL)	STO/SIL 2/SILCL 2 (EC motor without diagnostics) STO/SIL 3/SILCL 3 (stepper motor/EC motor with diagnostics)
Certificate issuing authority	German Technical Control Board (TÜV) Rheinland 01/205/5696.00/19, German Technical Control Board (TÜV) Rheinland UK Ltd. 01/205U/5696.00/22, UL E331130
Proof test interval	STO/20 a (stepper motor/EC motor without diagnostics) STO: 0.25 a (EC motor with diagnostics)
Hardware fault tolerance	1

Operating and environmental conditions	
Degree of protection	IP20
Ambient temperature	0 ... 50°C
Storage temperature	-25 ... 55°C
Note on ambient temperature	Observe the derating regarding the mounting clearance and output current.
Relative air humidity	5 - 90%, Non-condensing
Protection class	III
Overvoltage category	I
Pollution degree	2
Max. installation height	2,000 m
Shock resistance	Shock test with severity level 1 to FN 942017-5 and EN 60068-2-27 As per EN 60068-2
Vibration resistance	Transport application test with severity level 1 to FN 942017-4 and EN 60068-2-6 To EN 61800-5-1: frequency 10-57 Hz, amplitude 0.075 mm, frequency 57-150 Hz, 1 g As per EN 60068-2
CE mark (see declaration of conformity) ¹⁾	To EU EMC Directive To EC Machinery Directive In accordance with EU RoHS Directive
CE marking (see declaration of conformity) ²⁾	To UK instructions for EMC To UK regulations for machines To UK RoHS instructions
Approval	RCM trademark c UL us listed (OL)
KC mark	KC-EMV
LABS (PWIS) conformity	VDMA24364 zone III
Note on materials	RoHS-compliant

1) More information www.festo.com/catalogue/cmmt-st → Support/Downloads.

2) More information www.festo.com/catalogue/cmmt-st → Support/Downloads.

Derating required

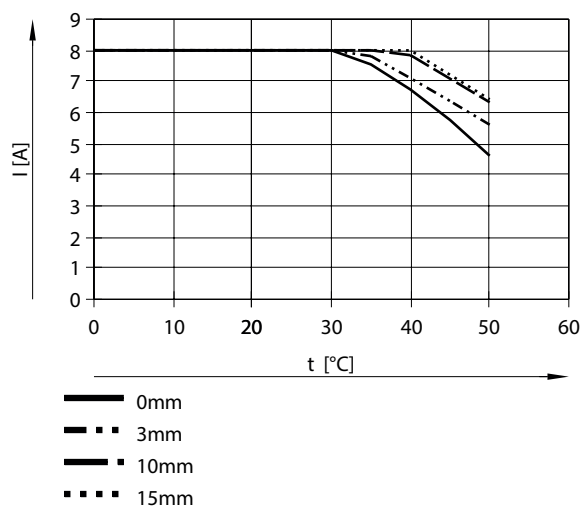

Mounting clearances may be required at output currents > 4.6 A to ensure the device reaches at least the specified service life. The mounting clearances required depend on the ambient temperature t and the output current I .

Mounting clearances from 0 mm are possible for a device combination consisting of several servo drives CMMT-ST. The following characteristic curves show the maximum permissible effective currents for the lateral mounting clearances 0 mm, 3 mm, 10 mm and 15 mm.

Dimensions

Dimensions – Servo drive CMMT-ST-...-MP

Download CAD data → www.festo.com

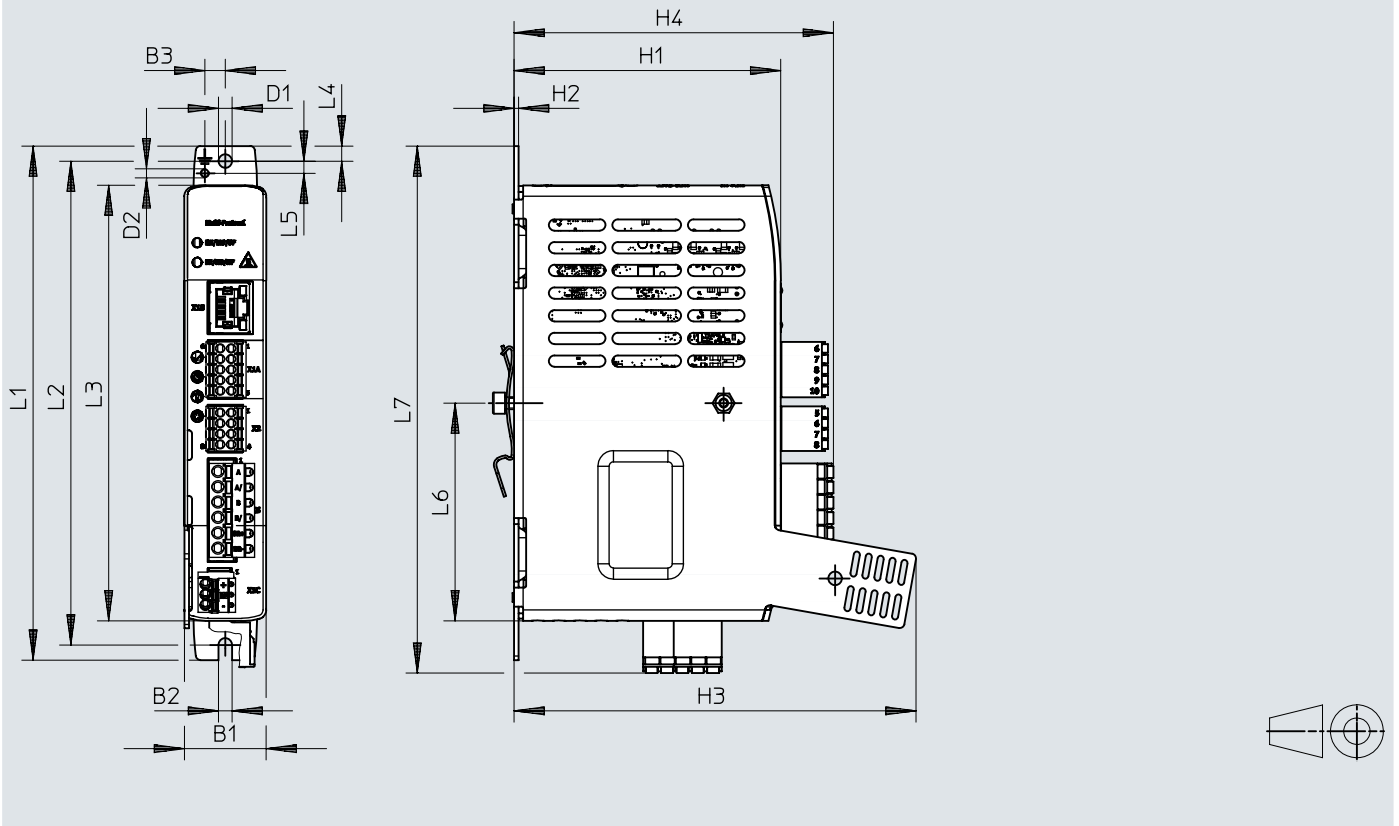

	B1	B2	B3	D1 Ø	D2	H1	H2	H3
CMMT-ST-C8-1C-MP	27	4,5	6,8	4,5	M3x0,5	88,3	1,5	133
	H4	L1	L2	L3	L4	L5	L6	L7
CMMT-ST-C8-1C-MP	105,7	170	160	144	5	4	72	174,3

Ordering data

Ordering data				
	Type of mounting ¹⁾	Field bus, protocol	Part no.	Type
	Mounting plate, attached with screws, With H-rail	EtherCAT [®] , EtherNet/IP, PROFINET IRT	★ 8163946	CMMT-ST-C8-1C-MP-S0

1) The plug assortment NEKM is included in the scope of delivery of the servo drive.

Accessories

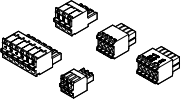
Assortment of plugs NEKM			
	Description	Part no.	Type
	CMMT-ST....MP	8173466	NEKM-C-23

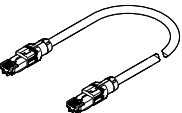
Connecting cable NEBC			
	Description	Part no.	Type
	Patch line for the daisy chain connection of the bus interfaces X19A/B, Not included in the scope of delivery of the servo drive, Ethernet category Cat 5e	★ 8082383	NEBC-R3G8-KS-0.2-N-S-R3G8-ET

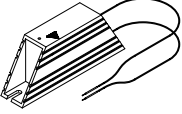
Braking resistor CACR					
	Resistance value	Brake resistance rating	Product weight	Part no.	Type
	6 Ohm	60 W	150 g	8189339	CACR-LE2-6-W60-V