

## Compact cylinders ADN/AEN, to ISO 21287

**FESTO**



Festo Core Range  
Solves the majority of your automation tasks

Worldwide: Quickest delivery – wherever, whenever

With the Festo Core Range, we have selected the most important products and functions from our broad product catalogue, and added the quickest delivery.

The Core Range offers you the best value

Just look  
for the  
star!

## Key features

### At a glance

Sensor slots on three sides for flush mounting of proximity switches

Piston rod with choice of male or female thread

Mounting option:  
Female thread and through-hole

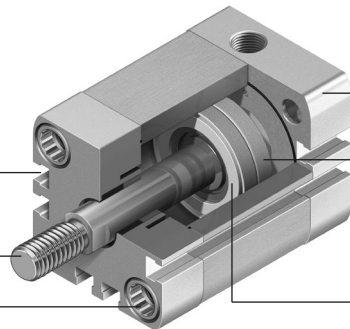

Centring hole in the end cap suitable for centring pins ZBS

Magnet for contactless position sensing

Integrated cushioning for absorbing residual energy

### More than the standard

- The compact cylinders comply with or are based on the ISO 21287 standard, depending on the piston diameter
- The ADN/AEN is characterised by its compact design and wide range of application thanks to the large number of variants
- The variants can be configured using a modular product system

### Powerful

- Integrated cushioning for absorbing residual energy
- Long service life thanks to exceptional cushioning characteristics and low friction values

### Convenient

- Easy to mount with a comprehensive range of mounting accessories for just about every type of installation
- Highly flexible thanks to the wide range of variants
- Contactless position sensing using proximity switches

### Reliable

- Optimised manufacturing methods, patented technology and more than 40 years of experience in the field of cylinders make Festo and ADN/AEN a great partner

### Cushioning types

#### Cushioning P

#### Operating mode

- The drive is fitted with polymer elastic end-position cushioning

#### Application

- Small loads
- Low speeds
- Small cushioning capacity

#### Benefits

- No adjustment required
- Saves time

#### Cushioning PPS

#### Operating mode

- The drive has self-adjusting, pneumatic end-position cushioning

#### Application

- Larger loads
- Higher speeds
- Larger cushioning capacity

#### Benefits

- No adjustment required
- Cushioning capacity is four times bigger than ADN-...-P
- Saves time
- Reduces noise

### Cushioning capacity of ISO 21287 and ISO 15552

The cushioning capacity of the compact cylinder ADN-...-PPS fills the gap between ADN-...-P and standards-based cylinders to ISO 15552.

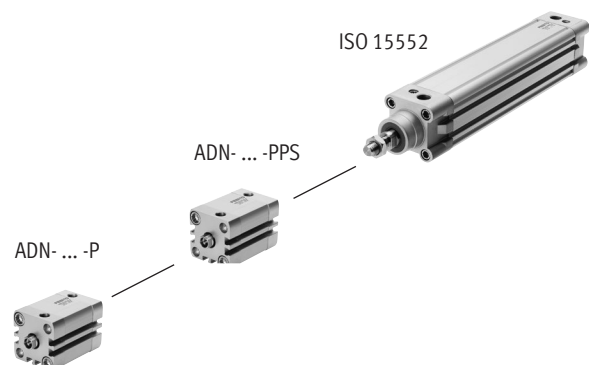

### For manufacturing lithium-ion batteries











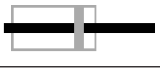

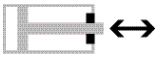



#### ADN-...-F1A

Recommended for production systems for manufacturing lithium-ion batteries. Metals with copper, zinc or nickel as the main constituent are excluded from use. Exceptions are nickel in steels, chemically nickel-plated surfaces, printed circuit boards, cables, electrical plug connectors and coils.





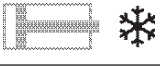



#### Accessories

Please contact your Festo representative for information on which accessories are suitable for manufacturing lithium-ion batteries.

## Key features

Variants from the modular product system		
Symbol	Key features	Description
	S1 Reinforced piston rod	Increased lateral loads. Absorbs many times more lateral load than a basic cylinder
	S2 Through piston rod	The piston rod can be used for attachment at both ends of the cylinder
	S6 Heat-resistant seals	Temperature resistance up to max. 120°C
	S10 Constant motion (slow speed) at low piston speeds	<ul style="list-style-type: none"> <li>• Break-away pressure: very low</li> <li>• Dynamic response: suitable for very slow, constant and stick-slip-free movements</li> </ul> Application example: slow, constant feed motion
	S11 Low friction	<ul style="list-style-type: none"> <li>• Break-away pressure: very low</li> <li>• Dynamic response: especially suitable for slow movements with considerably reduced system friction</li> <li>• Application example: slow applications where standstill is critical</li> </ul>
	S20 Through, hollow piston rod	The piston rod can be used for attachment at both ends of the cylinder. The piston rod is hollow inside. This means it can be used to carry vacuum or compressed air
	K2 Extended male piston rod thread	–
	K5 Special piston rod thread	Metric standard thread to ISO
	K8 Extended piston rod	–
	K10 Smooth anodised aluminium piston rod	Ideal for use in welding environments: <ul style="list-style-type: none"> <li>• Protection against welding spatter</li> <li>• Small moving masses</li> <li>• Harder surface compared to steel</li> <li>• Long service life</li> </ul>
	KP With clamping unit	Integrated clamping unit on the piston rod
	EL With end-position locking	Positive locking in the end position as a drop guard. If there is a drop in pressure, the cylinder is secured in its end position to prevent it from dropping
	Q Square piston rod	Protection against rotation. For position-oriented feeding
	R3 High corrosion protection	All external cylinder surfaces comply with corrosion resistance class 3 to Festo standard 940 070. The piston rod is made from corrosion- and acid-resistant steel
	R8 Dust protection with scraper	The cylinder has a hard-chrome-plated piston rod and a hard scraper, which protects against dry, dusty media
	TL Captive rating plate	Laser-etched rating plate. Easy identification for spare parts, even after years in a harsh environment
	TT Low temperature	Temperature resistance down to max. -40°C
	F1A Recommended for production plants for manufacturing lithium-ion batteries	Cylinders free of copper, zinc and nickel ( $\leq 1\%$ )





Product range overview

Function	Version	Type	Piston diameter	Stroke	Position sensing	Recommended for production systems for manufacturing lithium-ion batteries	Cushioning		
			[mm]	[mm]			Fixed	Self-adjusting	
					A	F1A	P	PPS	
Double-acting	<b>Basic version</b>								
		ADN	12	5, 10, 15, 20, 25, 30, 35, 40, 50, 60	1 ... 300	■	■	■	■ ∅ 20 ... 100
			16	5, 10, 15, 20, 25, 30, 35, 40, 50, 60, 70	1 ... 300				
			20	5, 10, 15, 20, 25, 30, 35, 40, 50, 60, 70	1 ... 300				
			25	5, 10, 15, 20, 25, 30, 35, 40, 50, 60, 70, 80	1 ... 300				
			32, 40, 50	5, 10, 15, 20, 25, 30, 35, 40, 50, 60, 70, 80	1 ... 400				
			63	10, 15, 20, 25, 30, 35, 40, 50, 60, 70, 80	1 ... 400				
			80, 100	10, 15, 20, 25, 30, 40, 50, 60, 80	1 ... 500				
			125	–	1 ... 500				
		ADN...-S2 Through piston rod	12, 16, 20, 25	–	1 ... 300	■	■	■	■ ∅ 20 ... 100
			32, 40, 50, 63	–	1 ... 400				
			80, 100, 125	–	1 ... 500				
		ADN...-S20 Through, hollow piston rod	16, 20, 25	–	1 ... 300	■	–	■	■ ∅ 20 ... 100
			32, 40, 50, 63	–	1 ... 400				
			80, 100, 125	–	1 ... 500				
	<b>Reinforced piston rod</b>								
		ADN...-S1	25	–	5 ... 300	■	–	■	–
			40, 63	–	10 ... 400				
			100	–	10 ... 500				
	<b>Protected against rotation with square piston rod</b>								
		ADN...-Q	12, 16, 20, 25	–	1 ... 300	■	–	■	–
			32, 40, 50, 63	–	1 ... 400				
			80, 100, 125	–	1 ... 500				
		ADN...-Q-S2 Through piston rod	12, 16, 20, 25	–	1 ... 300	■	–	■	–
32, 40, 50, 63			–	1 ... 400					
80, 100, 125			–	1 ... 500					
	ADN...-Q-S20 Through, hollow piston rod	16, 20, 25	–	1 ... 200	■	–	■	–	
		32, 40, 50, 63	–	1 ... 300					
		80, 100, 125	–	1 ... 400					
<b>Standard hole pattern, with clamping unit</b>									
	ADN...-KP	20, 25	–	10 ... 300	■	–	■	–	
		32, 40, 50, 63	–	10 ... 400					
		80, 100	–	10 ... 500					
<b>Standard hole pattern, with end-position locking</b>									
	ADN...-EL	20, 25	–	10 ... 300	■	–	■	–	
		32, 40, 50, 63	–	10 ... 400					
		80, 100	–	10 ... 500					

## Product range overview

Type	Male piston rod thread	Female piston rod thread	Extended male piston rod thread	Special piston rod thread	Extended piston rod	Smooth anodised piston rod	Heat-resistant seals max. 120 °C	Slow speed (constant motion)	Low friction	High corrosion protection	Dust protection	Low temperature	→ Page/Internet
	A	I	K2	K5	K8	K10	S6	S10	S11	R3	R8	TT	
<b>Basic version</b>													
<b>ADN</b>	■	■	■	■	■	■ from Ø 20	■	■	■	■	■ from Ø 20	■ Ø 20 ... 100	13
<b>ADN-...-S2</b> Through piston rod	■	■	■	■	■	-	■	-	-	-	-	■ Ø 20 ... 100	13
<b>ADN-...-S20</b> Through, hollow piston rod	■	-	■	■	■	-	■	-	-	-	-	-	13
<b>Reinforced piston rod</b>													
<b>ADN-...-S1</b>	■	■	■	■	■	-	■	-	-	■	-	-	13
<b>Protected against rotation with square piston rod</b>													
<b>ADN-...-Q</b>	■	■	■	■	■	-	■	-	-	-	-	-	13
<b>ADN-...-Q-S2</b> Through piston rod	■	■	■	■	■	-	■	-	-	-	-	-	13
<b>ADN-...-Q-S20</b> Through, hollow piston rod	■	-	■	■	■	-	■	-	-	-	-	-	13
<b>Standard hole pattern, with clamping unit</b>													
<b>ADN-...-KP</b>	■	■	■	■	■	-	-	-	-	-	-	-	44
<b>Standard hole pattern, with end-position locking</b>													
<b>ADN-...-EL</b>	■	■	■	■	■	-	-	-	-	-	-	-	53



Product range overview

Function	Version	Type	Piston diameter	Stroke	Position sensing	Cushioning		
			[mm]	[mm]		Fixed	Self-adjusting	
					A	P	PPS	
Double-acting	<b>Standard hole pattern, non-rotating with yoke</b>							
		ADNGF	12	5, 10, 15, 20, 25, 30, 40	1 ... 200	■	■	■ ∅ 20 ... 100
			16	5, 10, 15, 20, 25, 30, 40, 50	1 ... 200			
			20, 25	5, 10, 15, 20, 25, 30, 40, 50, 60	3 ... 200			
			32, 40, 50	5, 10, 15, 20, 25, 30, 40, 50, 60, 80	5 ... 300			
			63, 80	10, 15, 20, 25, 30, 40, 50, 60, 80	5 ... 300			
			100	10, 15, 20, 25, 30, 40, 50, 60, 80	5 ... 400			
		ADNGF-...S2 Through piston rod	12, 16	-	1 ... 200	■	■	■ ∅ 20 ... 100
			20, 25		3 ... 200			
			32, 40, 50, 63, 80, 100		5 ... 250			
	<b>Standard hole pattern, high-force cylinder</b>							
		ADNH	25	-	1 ... 150	■	■	-
			40					
			63					
100								
<b>Standard hole pattern, multi-position cylinder</b>								
	ADNM	25	-	1 ... 2 000	■	■	-	
		40						
		63						
		100						

## Product range overview

Type	Male piston rod thread	Female piston rod thread	Extended male piston rod thread	Special piston rod thread	Extended piston rod	Heat-resistant seals max. 120 °C	→ Page/Internet
	A	I	K2	K5	K8	S6	
<b>Standard hole pattern, non-rotating with yoke</b>							
<b>ADNGF</b>	-	-	-	-	-	■	adngf
<b>ADNGF-...-S2</b> Through piston rod	-	-	-	-	-	■	adngf
<b>Standard hole pattern, high-force cylinder</b>							
<b>ADNH</b>	■	■	■	■	■	■	adnh
<b>Standard hole pattern, multi-position cylinder</b>							
<b>ADNM</b>	■	■	■	■	■	■	adnh

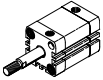
Product range overview

Function	Version	Type	Piston diameter	Stroke	Position sensing	Cushioning
			[mm]	[mm]	A	P
Single-acting	<b>Basic version</b>					
		AEN	12	1 ... 10	■	■
			16, 20, 25, 32, 40, 50, 63, 80, 100	1 ... 25		
		AEN...-Z Pulling	12	1 ... 10	■	■
			16, 20, 25, 32, 40, 50, 63, 80, 100	1 ... 25		
	<b>Protected against rotation with square piston rod</b>					
	AEN...-Q	16	1 ... 25	■	■	
		20, 25, 32, 40, 50, 63, 80, 100	1 ... 25			



## Product range overview

Type	Male piston rod thread	Female piston rod thread	Extended male piston rod thread	Special piston rod thread	Extended piston rod	Smooth anodised piston rod	Heat-resistant seals max. 120 °C	→ Page/Internet
	A	I	K2	K5	K8	K10	S6	
<b>Basic version</b>								
AEN	■	■	■	■	■	■ from Ø 20	■	63
AEN-...-Z Pulling	■	■	■	■	■	■ from Ø 20	■	63
<b>Protected against rotation with square piston rod</b>								
AEN-...-Q	■	■	■	■	■	-	■	63

## Peripherals overview

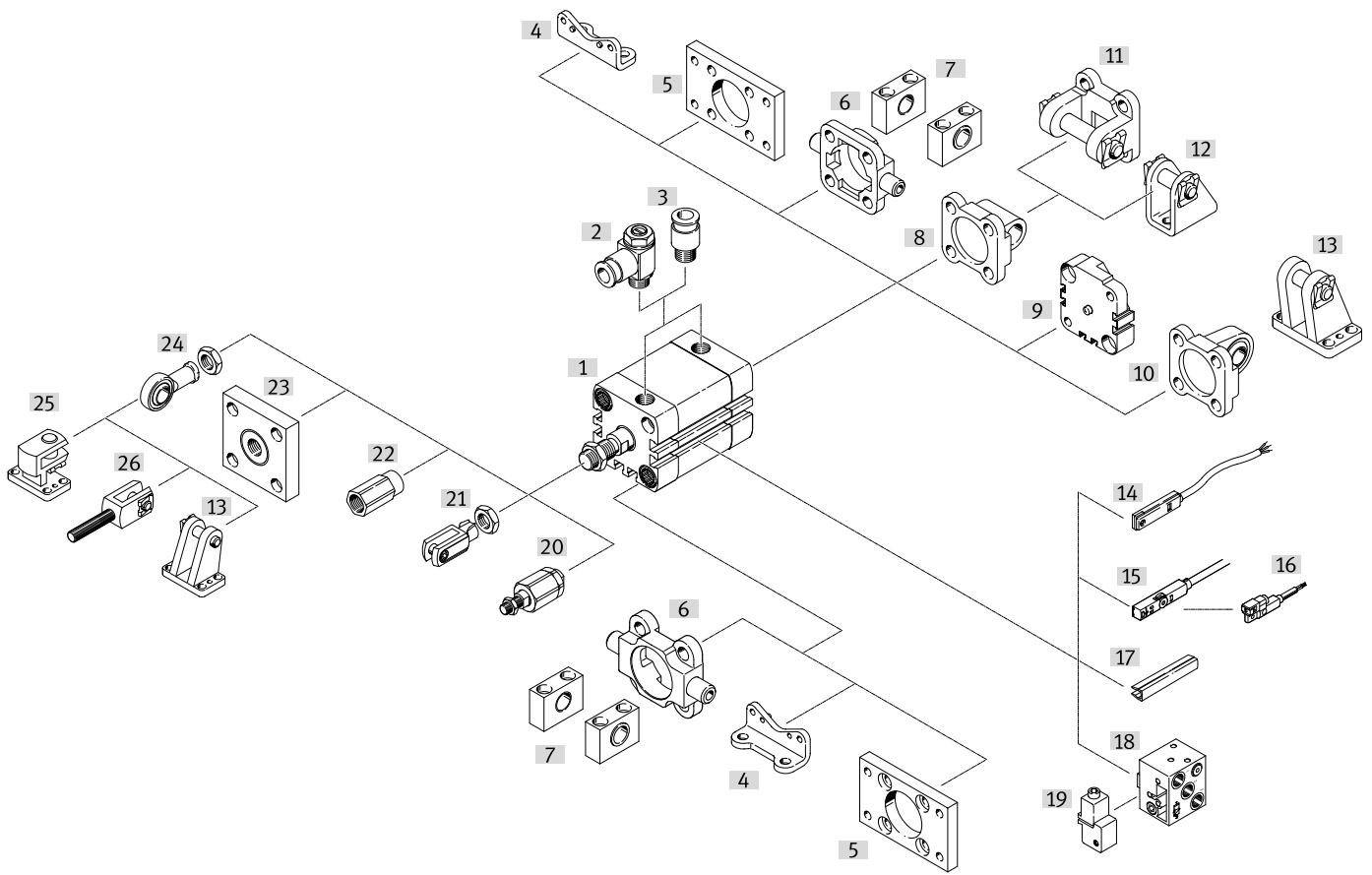

## Peripherals overview

Mounting attachments and accessories		Description	→ Page/Internet
[1]	Compact cylinder ADN	Double-acting cylinder	13
	Compact cylinder AEN	Single acting cylinder	63
[2]	One-way flow control valve GRLA/GRLZ	For regulating speed	89
[3]	Push-in fitting QS	For connecting tubing with standard O.D.	95
[4]	Foot mounting HNA	For bearing or end caps	78
[5]	Flange mounting FNC	For bearing or end caps	79
[6]	Trunnion flange ZNCF/CRZNG	For bearing caps	86
[7]	Trunnion support LNZG	For trunnion flange ZNCF/CRZNG	87
[8]	Swivel flange SNCL/SNCL-...-R3	For end caps	80
[9]	Multi-position kit DPNA	For connecting two cylinders with the same piston diameter to form a multi-position cylinder	83
[10]	Swivel flange SNCS/CRSNCS/SNCS-...-R3	For end caps	81
[11]	Swivel flange SNCB/SNCB-...-R3	For swivel flange SNCL	85
[12]	Clevis foot LBN/CRLBN	For swivel flange SNCL	84
[13]	Clevis foot LBG/LBG-...-R3	For swivel flange SNCS	82
[14]	Proximity switch SME-8	Can be integrated in the cylinder profile barrel	91
[15]	Proximity switch SME/SMT-8M	Can be integrated in the cylinder profile barrel	91
[16]	Proximity switch SMT-8G	Inserted into the slot lengthwise	91
[17]	Slot cover ABP-5-S	For protecting the sensor cables and the sensor slots from contamination	92
[18]	Proximity switch SMPO-8E	Pneumatic output signal	92
[19]	Mounting kit SMB-8E	For proximity switch SMPO-8E	92
[20]	Self-aligning rod coupler FK/CRFK/DARP	To compensate for radial and angular deviations	88
[21]	Rod clevis SG/CRSG	Permits a swivelling movement of the cylinder in one plane	88
[22]	Adapter AD	For mounting a suction cup on a hollow piston rod	88
[23]	Coupling piece KSG/KSZ	To compensate for radial deviations	88
[24]	Rod eye SGS/CRSGS	With spherical bearing	88
[25]	Right-angle clevis foot LQG	For rod eye SGS	89
[26]	Rod clevis SGA	With male thread	88

## Type codes

001	Series
ADN	Compact cylinder, double-acting, based on ISO 21287

002	Piston diameter [mm]
12	12
16	16
20	20
25	25
32	32
40	40
50	50
63	63
80	80
100	100
125	125

003	Stroke range [mm]
...	1 ... 500

004	Piston rod thread type
A	Male thread
I	Female thread

005	Cushioning
P	Elastic cushioning rings/plates on both sides
PPS	Pneumatic cushioning, self-adjusting at both ends

006	Position sensing
A	For proximity sensor

007	Special material properties
	None
F1A	Recommended for production plants for manufacturing lithium-ion batteries, F1A

008	Protection against rotation
	None
Q	Square piston rod

009	Piston rod type
	At one end
S2	Through piston rod
S20	Through, hollow piston rod

010	Custom thread
"M5"K5	M5
"M6"K5	M6
"M8"K5	M8
"M10"K5	M10
"M10x1,25"K5	M10x1.25
"M12"K5	M12
"M16"K5	M16
"M20"K5	M20
"M20x1,5"K5	M20x1.5

011	Temperature range
	Standard
S6	Heat-resistant seals max. 120 °C

012	Constant motion
	Standard
S10	Uniform, slow movement

013	Running characteristics
	Standard
S11	Low friction

014	Improved running performance
	None
K10	Smooth anodised aluminium coated piston rod

015	Corrosion protection
	Standard
R3	High corrosion protection

016	Increased lateral force
	None
S1	Reinforced piston rod or extended piston rod bearing

017	Captive rating plate
	Rating plate, glued
TL	Laser etched rating plate

018	Low temperature
	None
TT	-40 °C ... +80 °C

019	Scraper variant
	Standard
R8	Dust protection

020	EU certification
	None
EX4	II 2GD

## Datasheet

Function  
cushioning P

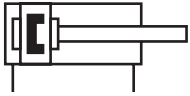

PPS cushioning

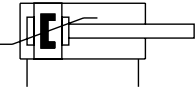

- - Diameter  
12 ... 125 mm

- - Stroke length  
1 ... 500 mm

Variants → page 3



www.festo.com



### General technical data

Piston diameter	12	16	20	25	32	40	50	63	80	100	125	
Standard	Based on ISO 21287		Conforms to ISO 21287								Based on ISO 21287	
Design	Piston											
	Piston rod											
	Cylinder barrel											
Operating mode	Double-acting											
Cushioning	Elastic cushioning rings/plates at both ends											
P	Elastic cushioning rings/plates at both ends											
PPS	Pneumatic cushioning, self-adjusting at both ends										-	
Cushioning length	Pneumatic cushioning, self-adjusting at both ends											
PPS [mm]	-	-	3	3.5	4	5	6	7	7.5	10	-	
Position sensing	Via proximity switch											
Type of mounting	Via through-hole											
	With female thread											
	With accessories											
Mounting position	Any											

### Technical data – Basic version and variants

Piston diameter	12	16	20	25	32	40
Pneumatic connection	Pneumatic connection					
-	M5	M5	M5	M5	G1/8	G1/8
S1	-	-	-	M5	-	M5
Female piston rod thread	Female piston rod thread					
-	M3	M4	M6	M6	M8	M8
K5	-	-	M5	M5	M6	M6
S1	-	-	-	M6	-	M10
S1-K5	-	-	-	M5	-	M8
Male piston rod thread	Male piston rod thread					
-	M5	M6	M8	M8	M10x1.25	M10x1.25
K5	M6	M8	M10; M10x1.25	M10; M10x1.25	M10; M12	M10; M12
S1	-	-	-	M8	-	M12x1.25
S1-K5	-	-	-	M10; M10x1.25	-	M10x1.25; M12
Q-K5	M6	M8	M10; M10x1.25	M10; M10x1.25	M10	M10
Max. torsional backlash of the piston rod [°]	Max. torsional backlash of the piston rod [°]					
Q	2	1.8	1.6	1.6	1.2	1.2

## Datasheet

Technical data – Basic version and variants												
Piston diameter	50		63		80		100		125			
Pneumatic connection												
–	G1/8		G1/8		G1/8		G1/8		G1/4			
S1	–		G1/8		–		G1/8		–			
Female piston rod thread												
–	M10		M10		M12		M12		M16			
K5	M8		M8		M10		M10		–			
S1	–		M12		–		M16		–			
S1-K5	–		M10		–		–		–			
Male piston rod thread												
–	M12x1.25		M12x1.25		M16x1.5		M16x1.5		M20x1.5			
K5	M12; M16		M12; M16		M16; M20; M20x1.5		M16; M20; M20x1.5		M20			
S1	–		M16x1.5		–		M20x1.5		–			
S1-K5	–		M12x1.25; M16		–		M16x1.5; M20		–			
Q-K5	M12		M12		M16		M16		M20			
Max. torsional backlash of the piston rod [°]												
Q	1		1		0.8		0.8		0.8			
Operating and environmental conditions												
Piston diameter	12	16	20	25	32	40	50	63	80	100	125	
Operating medium	Compressed air to ISO 8573-1:2010 [7:4:4]											
Note on the operating/pilot medium	Lubricated operation possible (in which case lubricated operation will always be required)											
Operating pressure												
in [MPa]												
–	0.1 ... 1		0.06 ... 1									
PPS	–		0.15 ... 1		0.1 ... 1						–	
Q	0.15 ... 1		0.1 ... 1									
Q-S6	0.15 ... 0.6		0.1 ... 0.6									
S1	–		0.1 ... 1		–		0.1 ... 1		–		0.1 ... 1	
S2, S20	0.15 ... 1		0.12 ... 1		0.1 ... 1		0.08 ... 1					
S6	0.1 ... 1		0.06 ... 1									
S11	0.045 ... 1				0.025 ... 1							
R8, TT	–		0.15 ... 1		0.1 ... 1						–	
in [bar]												
–	1 ... 10		0.6 ... 10									
PPS	–		1.5 ... 10		1 ... 10						–	
Q	1.5 ... 10		1 ... 10									
Q-S6	1.5 ... 6		1 ... 6									
S1	–		1 ... 10		–		1 ... 10		–		1 ... 10	
S2, S20	1.5 ... 10		1.2 ... 10		1 ... 10		0.8 ... 10					
S6	1 ... 10		0.6 ... 10									
S11	0.45 ... 10				0.25 ... 10							
R8, TT	–		1.5 ... 10		1 ... 10						–	
in [psi]												
–	14.5 ... 145		8.7 ... 145									
PPS	–		21.76 ... 145		14.5 ... 145						–	
Q	21.76 ... 145		14.5 ... 145									
Q-S6	21.76 ... 87		14.5 ... 87									
S1	–		14.5 ... 145		–		14.5 ... 145		–		14.5 ... 145	
S2, S20	21.76 ... 145		17.4 ... 145		14.5 ... 145		11.6 ... 145					
S6	14.5 ... 145		8.7 ... 145									
S11	6.53 ... 145				3.63 ... 145							
R8, TT	–		21.76 ... 145		14.5 ... 145						–	
Ambient temperature <sup>1)</sup> [°C]												
–	–20 ... +80											
S6	0 ... +120											
S10, S11	+5 ... +80											
R3	–20 ... +80											
TT	–		–40 ... +80								–	

1) Note operating range of proximity switches

# Datasheet

Operating and environmental conditions											
Piston diameter	12	16	20	25	32	40	50	63	80	100	125
Corrosion resistance class CRC <sup>1)</sup>											
-	2 - Moderate corrosion stress										
R3	3 - High corrosion stress										
F1A	0 - no corrosion stress										
ATEX	Selected types → <a href="http://www.festo.com">www.festo.com</a>										

1) More information: [www.festo.com/x/topic/crc](http://www.festo.com/x/topic/crc)

Forces [N] and impact energy [J]											
Piston diameter	12	16	20	25	32	40	50	63	80	100	125
Theoretical force at 6 bar, advancing											
-	68	121	188	295	483	754	1178	1870	3016	4712	7363
S1	-	-	-	295	-	754	-	1870	-	4712	-
S2	51	90	141	247	415	686	1057	1750	2827	4524	7069
Theoretical force at 6 bar, retracting											
-	51	90	141	247	415	686	1057	1750	2827	4524	7069
S1	-	-	-	247	-	633	-	1681	-	4417	-
S2	51	90	141	247	415	686	1057	1750	2827	4524	7069
Max. impact energy in the end positions											
-	0.07	0.15	0.2	0.3	0.4	0.7	1	1.3	1.8	2.5	3.3
S1	-	-	-	0.3	-	0.7	-	1.3	-	2.5	-
S6, S10, S11, TT	0.035	0.075	0.1	0.15	0.2	0.35	0.5	0.65	0.9	1.25	1.75
K10	-	-	0.16	0.24	0.32	0.56	0.8	1	1.4	2	2.6
S20	-	0.016	0.024	0.083	0.15	0.39	0.48	0.62	0.8	0.9	0.95



**Note**

These specifications represent the maximum values that can be achieved. The maximum permissible impact energy must be observed.

Permissible impact speed:

$$V = \sqrt{\frac{2 \times E}{m_1 + m_2}}$$

V Permissible impact speed  
E max. impact energy  
m1 Moving mass (drive)  
m2 Moving payload

Maximum permissible mass:

$$m_2 = \frac{2 \times E}{v^2} - m_1$$



**Note**

The maximum impact energy is still maintained in combination with cushioning PPS.

**Max. energy conversion capacity [J]**

Piston diameter	20	25	32	40	50	63	80	100
For cushioning PPS	0.65	0.8	1	1.7	2.8	4.8	8	12

**Max. lateral force F<sub>q</sub> as a function of projection x**

∅ 12 ... 63

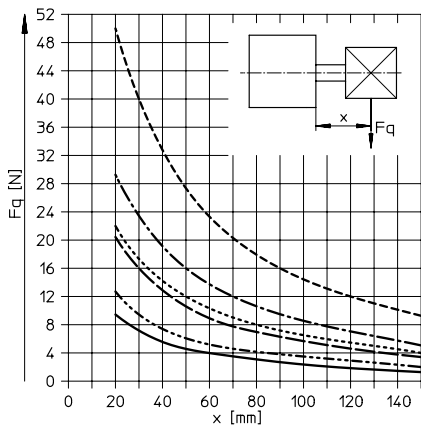

∅ 80 ... 125

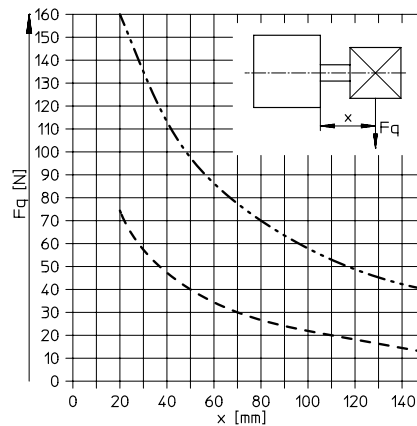

- ∅ 12
- · - · - ∅ 16
- - - ∅ 20
- ∅ 25
- · - · - ∅ 32/40
- - - ∅ 50/63
- - - ∅ 80/100
- · - · - ∅ 125

Datasheet

Max. lateral load  $F_q$  as a function of projection  $x$  and lever arm  $a$

Q – Square piston rod

$\varnothing 12$

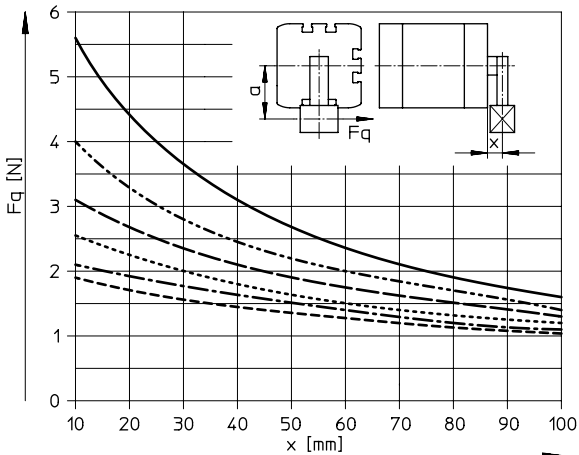

- a = 5 mm
- · - · - a = 10 mm
- - - a = 15 mm
- · · · · a = 20 mm
- · - · - a = 25 mm
- - - a = 30 mm

$\varnothing 16$

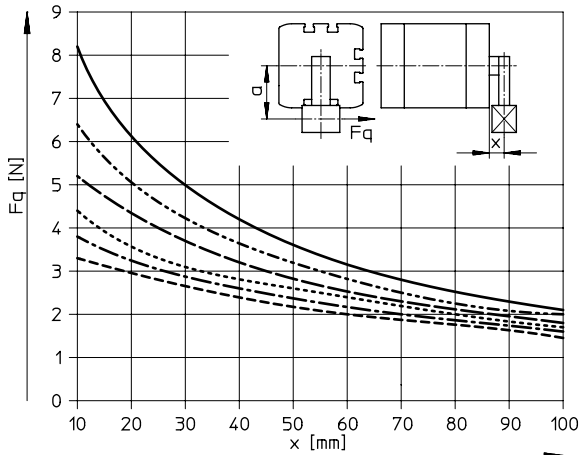

- a = 5 mm
- · - · - a = 10 mm
- - - a = 15 mm
- · · · · a = 20 mm
- · - · - a = 25 mm
- - - a = 30 mm

$\varnothing 20/25$

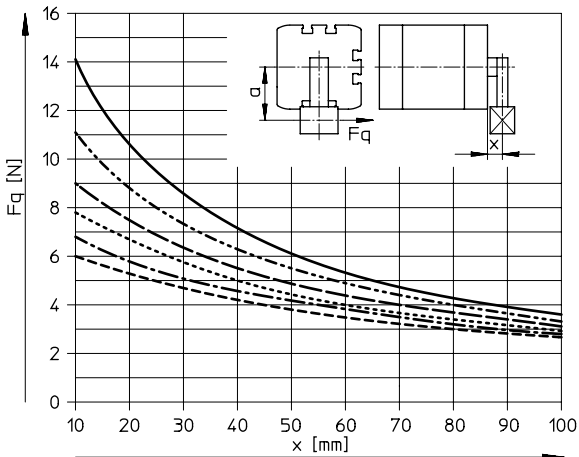

- a = 5 mm
- · - · - a = 10 mm
- - - a = 15 mm
- · · · · a = 20 mm
- · - · - a = 25 mm
- - - a = 30 mm

$\varnothing 32/40$

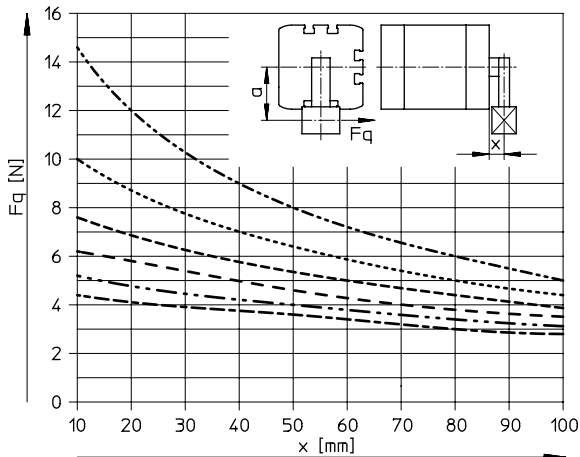

- · - · - a = 10 mm
- · · · · a = 20 mm
- - - a = 30 mm
- - - a = 40 mm
- · - · - a = 50 mm
- · - · - a = 60 mm

Note

• For cantilevers that are larger than those shown in the diagrams, torques on the piston rod must be ruled out.

• If  $a = 0$ , the corresponding lateral load line of the basic version of the ADN can be used (→ page 15).



## Datasheet

### Max. lateral load $F_q$ as a function of projection $x$ and lever arm $a$

Q – Square piston rod

$\varnothing 50/63$

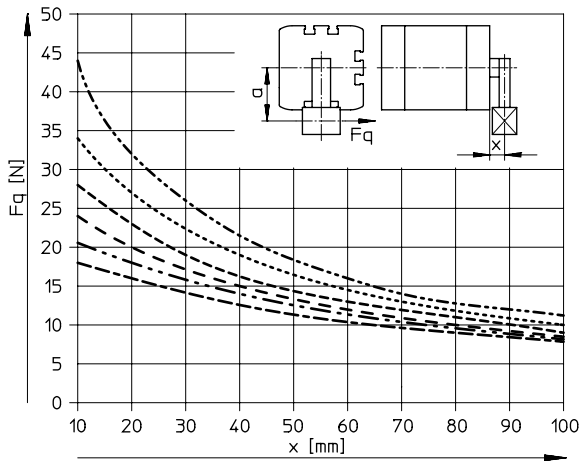

- ······ a = 10 mm
- ······ a = 20 mm
- - - - - a = 30 mm
- - - - - a = 40 mm
- · · · · a = 50 mm
- · · · · a = 60 mm

$\varnothing 80/100$

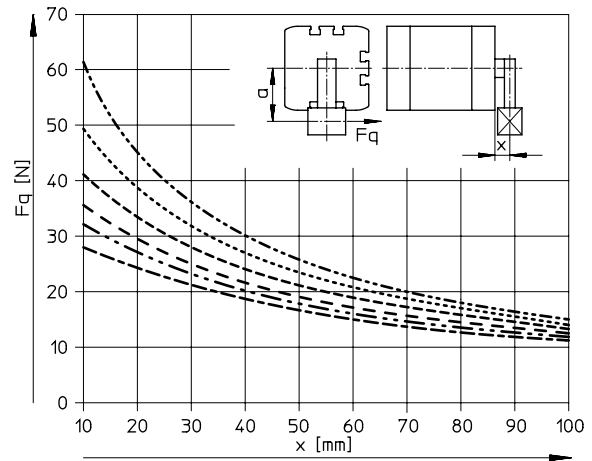

- ······ a = 10 mm
- ······ a = 20 mm
- - - - - a = 30 mm
- - - - - a = 40 mm
- · · · · a = 50 mm
- · · · · a = 60 mm

$\varnothing 125$

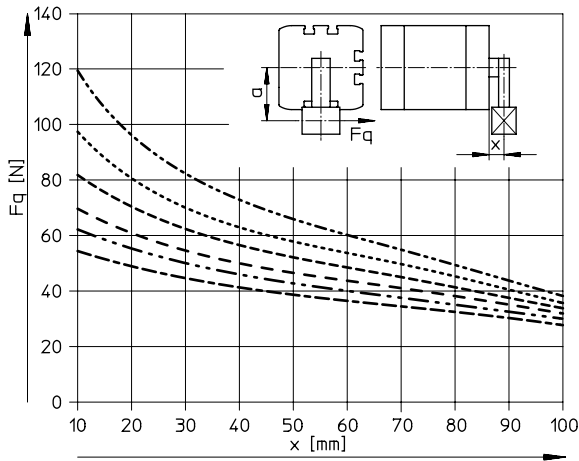

- ······ a = 10 mm
- ······ a = 20 mm
- - - - - a = 30 mm
- - - - - a = 40 mm
- · · · · a = 50 mm
- · · · · a = 60 mm

#### Note

- For cantilevers that are larger than those shown in the diagrams, torques on the piston rod must be ruled out.

- If  $a = 0$ , the corresponding lateral load line of the basic version of the ADN can be used (→ page 15).

# Datasheet

## Max. lateral force $F_q$ as a function of projection $x$

S1 – Reinforced piston rod

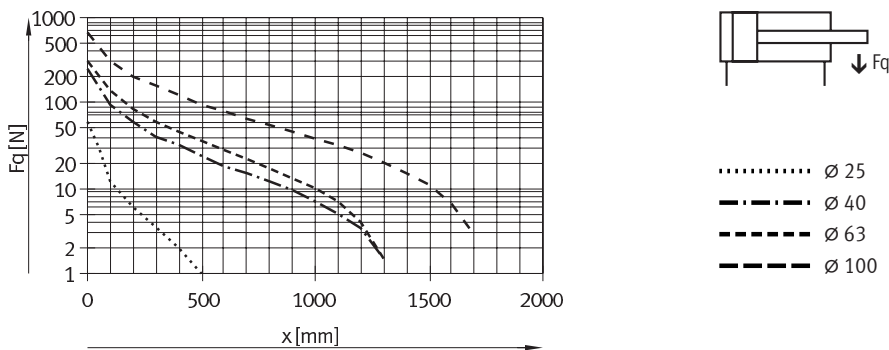

Weight [g]											
Piston diameter	12	16	20	25	32	40	50	63	80	100	125
<b>ADN-...</b>											
Product weight with 0 mm stroke	64	75	128	181	265	361	531	755	1140	1741	2952
Additional weight per 10 mm stroke	12	14	22	26	29	38	51	60	80	99	116
Moving mass with 0 mm stroke	11	18	32	41	76	103	164	222	431	595	1020
Additional mass per 10 mm stroke	2	4	6	6	9	9	16	16	25	25	29
<b>ADN-...-I</b>											
Product weight with 0 mm stroke	62	71	119	172	240	318	489	713	1012	1605	2768
Additional weight per 10 mm stroke	12	14	22	26	29	38	51	60	80	99	116
Moving mass with 0 mm stroke	9	14	23	32	51	60	122	180	303	459	836
Additional mass per 10 mm stroke	2	4	6	6	9	9	16	16	25	25	29
<b>ADN-...-S2</b>											
Product weight with 0 mm stroke	68	83	144	200	294	389	582	805	1220	1830	3245
Additional weight per 10 mm stroke	15	18	29	33	38	47	68	76	105	123	156
Moving mass with 0 mm stroke	15	26	48	55	105	127	205	265	493	665	1308
Additional mass per 10 mm stroke	5	8	13	13	18	18	33	32	50	49	69
<b>ADN-...-S20</b>											
Product weight with 0 mm stroke	–	84	140	193	284	377	563	786	1162	1771	3076
Additional weight per 10 mm stroke	–	17	27	31	36	45	62	71	96	115	136
Moving mass with 0 mm stroke	–	22	42	48	96	115	186	245	435	606	1099
Additional mass per 10 mm stroke	–	7	11	11	16	16	27	27	41	41	49
<b>ADN-...-Q</b>											
Product weight with 0 mm stroke	65	78	132	180	270	361	537	749	1144	1741	2945
Additional weight per 10 mm stroke	12	14	22	26	28	37	46	55	75	94	108
Moving mass with 0 mm stroke	11	17	32	41	73	–	153	209	413	575	985
Additional mass per 10 mm stroke	2	4	6	6	8	8	11	11	20	20	21
<b>ADN-...-S1</b>											
Product weight with 0 mm stroke	–	–	–	183	–	394	–	886	–	2710	–
Additional weight per 10 mm stroke	–	–	–	26	–	44	–	68	–	136	–
Moving mass with 0 mm stroke	–	–	–	45	–	134	–	308	–	737	–
Additional mass per 10 mm stroke	–	–	–	6	–	15	–	24	–	38	–
<b>ADN-...-PPS</b>											
Product weight with 0 mm stroke	–	–	128	173	272	372	547	773	1162	1766	–
Additional weight per 10 mm stroke	–	–	22	26	29	38	51	60	80	99	–
Moving mass with 0 mm stroke	–	–	33	39	83	114	180	240	453	620	–
Additional mass per 10 mm stroke	–	–	6	6	9	9	16	16	25	25	–
<b>ADN-...-TT/-R8</b>											
Product weight with 0 mm stroke	–	–	133	181	280	380	561	786	1167	1768	–
Additional weight per 10 mm stroke	–	–	22	26	29	38	51	60	80	99	–
Moving mass with 0 mm stroke	–	–	35	44	82	109	175	234	447	612	–
Additional mass per 10 mm stroke	–	–	6	6	9	9	16	16	25	25	–

## Datasheet

<b>Weight [g]</b>											
Piston diameter	12	16	20	25	32	40	50	63	80	100	125
<b>ADN-...-K10</b>											
Product weight with 0 mm stroke	–	–	131	183	281	373	562	780	1158	1754	2932
Additional weight per 10 mm stroke	–	–	18	22	23	29	40	48	61	80	86
Moving mass with 0 mm stroke	–	–	35	43	92	115	195	247	449	608	1000
Additional mass per 10 mm stroke	–	–	2	2	3	0	5	4	6	6	0
<b>ADN-...-R3</b>											
Product weight with 0 mm stroke	64	75	128	181	265	361	531	755	1301	2171	2952
Additional weight per 10 mm stroke	12	14	22	26	29	38	51	60	80	99	116
Moving mass with 0 mm stroke	11	18	32	41	76	103	164	222	431	595	1020
Additional mass per 10 mm stroke	2	4	6	6	9	9	16	16	25	25	29
<b>ADN-...-K8</b>											
Additional weight and mass per 10 mm piston rod extension	2	4	6	6	9	9	16	16	25	25	–
<b>ADN-...-K2</b>											
Additional weight and mass per 10 mm extended piston rod thread	2	2	4	4	6	6	9	9	16	16	–

## Datasheet

### Materials

#### Sectional view

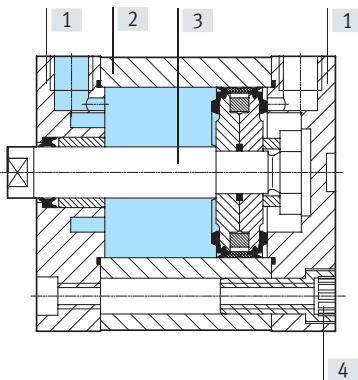

Compact cylinder	Basic version, Q	R8	S6, S10, S11	R3	K10	F1A
[1] Cover						
$\varnothing$ 12 ... 63	Anodised aluminium					
$\varnothing$ 80 ... 125	Coated die-cast aluminium					
[2] Cylinder barrel	Anodised aluminium					
[3] Piston rod	High-alloy steel	Hard-chrome-plated tempered steel	High-alloy steel		Anodised aluminium	High-alloy steel
[4] Flange screws						
$\varnothing$ 12 ... 16	High-alloy steel			High-alloy steel	–	Steel, chemically nickel-plated
$\varnothing$ 20 ... 63	Galvanised steel			Tempered steel	Galvanised steel	
$\varnothing$ 80 ... 125	Standard screws, galvanised steel			Standard screws, high-alloy steel	Standard screws, galvanised steel	
– Seals	Polyurethane		Fluoro rubber	Polyurethane		Polyurethane
Note on materials						
ADN-...	RoHS-compliant					
	LABS (PWIS) conformity: VDMA24364-B1/B2-L					
$\varnothing$ 12 ... 63	Cleanroom class 6 to ISO 14644-1					
ADN-...-S10/11	Contains paint-wetting impairment substances					
	LABS (PWIS) conformity: VDMA24364-Zone III					
ADN-...-F1A	Metals with copper, zinc or nickel as the main constituent are excluded from use. Exceptions are nickel in steel, chemically nickel-plated surfaces, printed circuit boards, cables, electrical plug connectors and coils.					

Datasheet

Dimensions – Basic version

Download CAD data → [www.festo.com](http://www.festo.com)

∅ 12 ... 63

∅ 80 ... 125

∅ 32 ... 63

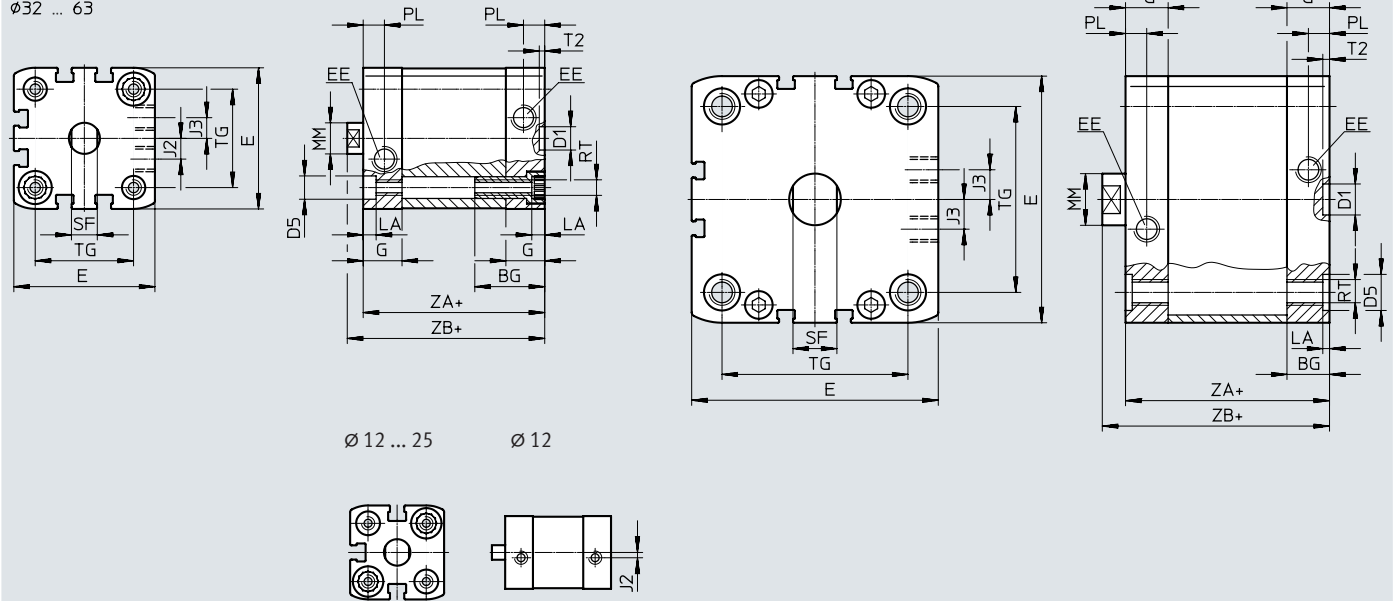

+ = plus stroke length  
 [1] = Drilled hole for centring pin/sleeve

∅ [mm]	BG min.	D1 ∅ H9	D5 ∅	E	EE	G	J2	J3	PW +0.2
12	17	9	6 <sup>F9</sup>	27.5 <sup>+0.3</sup>	M5	10.5	2	–	3.5
16				29 <sup>+0.3</sup>		11	2.6		
20	35.5 <sup>+0.3</sup>		12	5					
25	19.5		9 <sup>F9</sup>		39.5 <sup>+0.3</sup>	15	6		
32					47 <sup>+0.3</sup>		8		
40	26		12	12 <sup>F9</sup>	54.5 <sup>+0.3</sup>	11.5	11.5		
50	27	65.5 <sup>+0.3</sup>			20				
63		75.5 <sup>+0.3</sup>		2.6					
80	17	15	15		95.5 <sup>+0.6</sup>	21.5	20		
100	21.5			113.5 <sup>+0.6</sup>					
125	20	–	134.6 <sup>+0.3</sup>	G1/4	20	21.15	–		

∅ [mm]	MM ∅	PL +0.2	RT	ST h13	T2 +0.1	TG ±0.2	ZA ±0.6	ZB +1.2	PPS +1.3	
12	6	6	M4	5	2.1	16	35	39.2	–	
16	8			7		18		39.7		
20	10		M5	9		22	37	42.5	42.5	
25					26	39	44.5	45.3		
32	12		8.2	M6	10	2.6	32.5	44	50	50.6
40							38	45	51.1	51.7
50	16	M8		13	46.5	49	52.7	53.2		
63					56.5		56.5	57		
80	20	M10		17	72	54	62.9	63.4		
100					89	67	76	76.8		
125	25	10.5	M12	21	110	81	92	–		

## Datasheet

### Dimensions – Variants

Download CAD data → [www.festo.com](http://www.festo.com)

#### Basic version

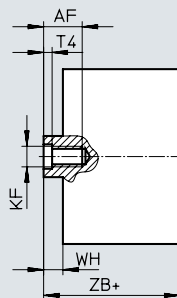
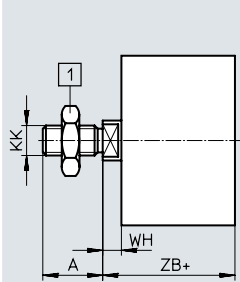

[1] Hex nut DIN 439-B  
only with  $\varnothing 32 \dots 125$

+ = plus stroke length

#### S2 – Through piston rod

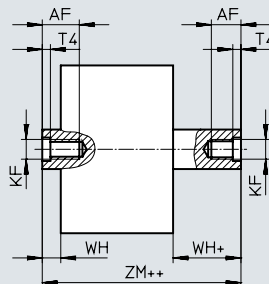
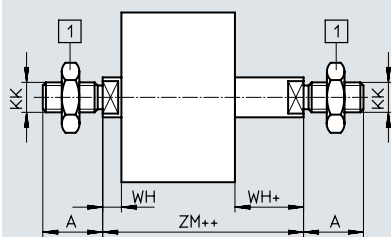

[1] Hex nut DIN 439-B  
only with  $\varnothing 32 \dots 125$

+ = plus stroke length

++ = plus 2x stroke length

#### S20 – Through, hollow piston rod

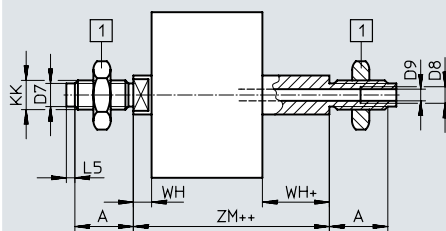

[1] Hex nut DIN 439-B  
only with  $\varnothing 32 \dots 125$

+ = plus stroke length

++ = plus 2x stroke length

#### K2 – Extended male piston rod thread

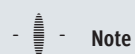
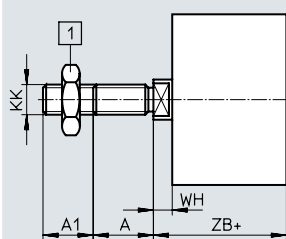

#### Note

In combination with variants S2/S20, the piston rod thread is extended at both ends

[1] Hex nut DIN 439-B  
only with  $\varnothing 32 \dots 125$

+ = plus stroke length

#### K5 – Special piston rod thread

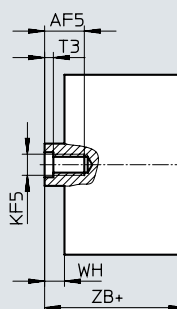
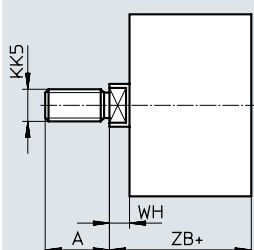

Datasheet

Dimensions – Variants

Download CAD data → [www.festo.com](http://www.festo.com)

K8 – Extended piston rod

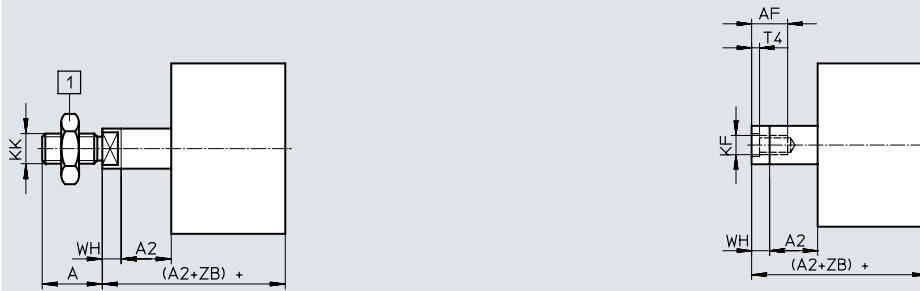

**Note**  
 In combination with variants S2/ S20, the piston rod thread is extended at one end  
 [1] Hex nut DIN 439-B only with  $\varnothing 32 \dots 125$   
 + = plus stroke length

R8 – Dust protection / TT – Low temperature

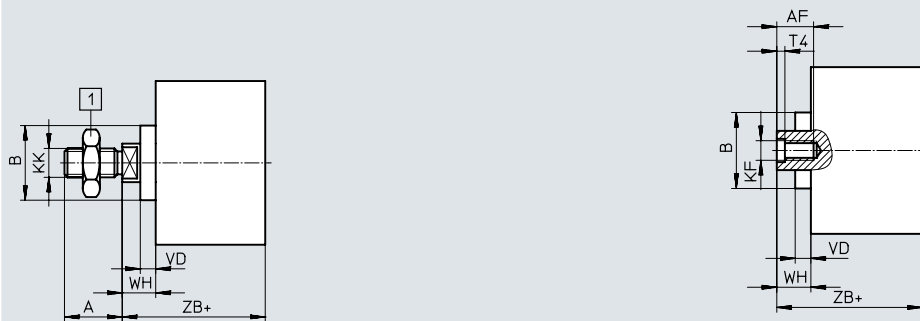

[1] Hex nut DIN 439-B only with  $\varnothing 32 \dots 125$   
 + = plus stroke length

$\varnothing$ [mm]	A	A1	A2	AF min.	AF5 min.	B $\varnothing$	D7 $\varnothing$	D8	D9 $\varnothing$	L5	KF	KF5	KK
12	10	1 ... 10	1 ... 300	8	–	–	–	–	–	–	M3	–	M5
16	12			10	–	–	4.5		3.2	3	M4	–	M6
20	16	1 ... 20	1 ... 400	14	12	18	6	–	3.8	2	M6	M5	M8
25				19	16	14	27		8	4.5	3	M8	M6
32	22	1 ... 30	1 ... 500	20	16	31	10	–	6	3.5	M10	M8	M12x1.25
40													
50	28	1 ... 40	1 ... 500	25	–	–	–	G1/4	11.7	–	M16	–	M20x1.5
63													

$\varnothing$ [mm]	KK5	T3	T4	VD	WH			ZB			ZM	
					+1.3	PPS +1.4	R8/TT +1.3	+1.2	PPS +1.3	R8/TT +1.2		PPS
12	M6	–	1.5	–	4.2	–	–	39.2	–	–	44.5 <sup>+0.5</sup>	–
16	M8	–	1.5	–	4.7	–	–	39.7	–	–	45.7 <sup>+0.5</sup>	–
20	M10x1.25 M10	2	2.6	5.2	5.5	5.5	10.5	42.5	42.5	47.5	49.5 <sup>+0.5</sup>	49.5 <sup>+0.5</sup>
25								44.5	45.3	49.5	51.5 <sup>+0.5</sup>	51.5 <sup>+0.5</sup>
32	M10 M12	2.6	3.3	6.4	6	6.5	12.5	50	50.6	56.5	57.5 <sup>+0.5</sup>	58.6 <sup>+0.6</sup>
40								51.1	51.7	57.5	58.6 <sup>+0.6</sup>	59.7 <sup>+0.7</sup>
50	M12 M16	3.3	4.7	6.4	7.7	8.2	14.7	52.7	53.2	59.7	62.0 <sup>+0.6</sup>	63.1 <sup>+0.7</sup>
63								56.5	57	63.6	65.4 <sup>+0.6</sup>	66.5 <sup>+0.7</sup>
80	M16 M20x1.5 M20	4.7	6.1	6.4	8.9	9.4	15.4	62.9	63.4	69.4	73.2 <sup>+0.6</sup>	74.3 <sup>+0.7</sup>
100								76	76.8	82.5	86.4 <sup>+0.6</sup>	88 <sup>+0.7</sup>
125	M20	–	7	–	11	–	–	92	–	–	104.4 <sup>+0.6</sup>	–

## Datasheet

### Dimensions – Variants

Download CAD data → [www.festo.com](http://www.festo.com)

#### Q – Square piston rod

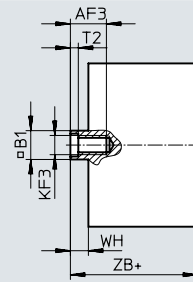
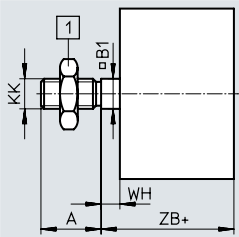

[1] Hex nut DIN 439-B  
only with  $\varnothing$  32 ... 125

+ = plus stroke length

#### Q-S2 – Square, through piston rod

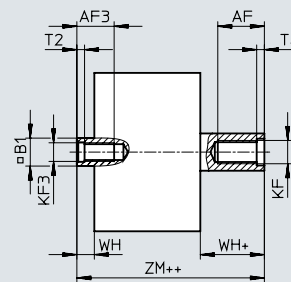
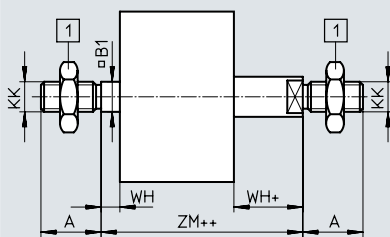

[1] Hex nut DIN 439-B  
only with  $\varnothing$  32 ... 125

+ = plus stroke length

++ = plus 2x stroke length

#### Q-S20 – Square, through, hollow piston rod

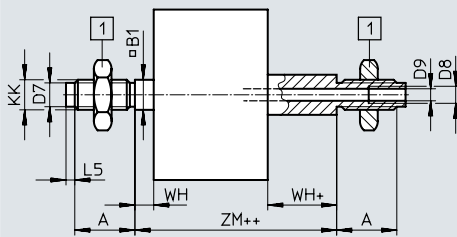

[1] Hex nut DIN 439-B  
only with  $\varnothing$  32 ... 125

+ = plus stroke length

++ = plus 2x stroke length

#### Q-K2 – Square piston rod with extended male thread

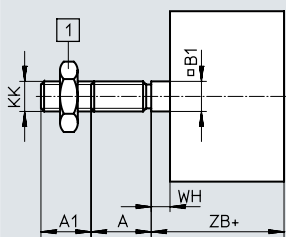

#### Note

In combination with variants S2/  
S20, the piston rod thread is ex-  
tended at both ends.

[1] Hex nut DIN 439-B  
only with  $\varnothing$  32 ... 125

+ = plus stroke length

#### Q-K5 – Square piston rod with special piston rod thread

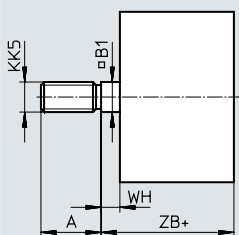

+ = plus stroke length



## Datasheet

## Dimensions – Variants

Download CAD data → [www.festo.com](http://www.festo.com)

Q-K8 – Square, extended piston rod

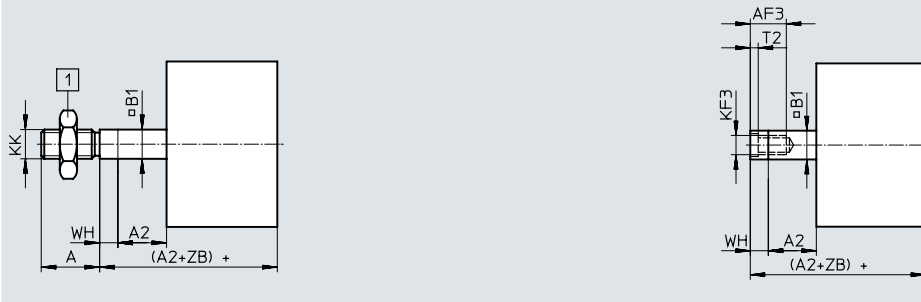
-  - **Note**In combination with variants S2/  
S20, the piston rod thread is ex-  
tended at both ends.[1] Hex nut DIN 439-B  
only with  $\varnothing 32 \dots 125$ 

+ = plus stroke length

$\varnothing$ [mm]	A	A1	A2	AF min.	AF3 min.	B1 □	D7 $\varnothing$	D8	D9 $\varnothing$	
12	10	1 ... 10	1 ... 300	8	8	5.5	–	–	–	
16	12			10	10	7	4.5		3.2	
20	16			14	12	9	6		3.8	
25		1 ... 20	16	14	10	8	4.5			
32	19	1 ... 400	1 ... 500	20	16	12	10	–	6	
40				20	16	12	10		8	
50				22	20	16	12		10	6
63	28	1 ... 30	1 ... 500	20	20	16	–	G1/8	8	
80				25	24	20			G1/4	11.7
100				1 ... 40	25	24				20
125	40	1 ... 40								

$\varnothing$ [mm]	L5	KF	KF3	KK	KK5	T2	T4	WH +1.3	ZB +1.2	ZM
12	–	M3	M3	M5	M6	1.5	1.5	4.2	39.2	44.5 <sup>+0.5</sup>
16	3	M4	M4	M6	M8			4.7	39.7	45.7 <sup>+0.5</sup>
20	2	M6	M5	M8	M10x1.25 M10	2	2.6	5.5	42.5	49.5 <sup>+0.5</sup>
25								44.5	51.5 <sup>+0.5</sup>	
32	3	M8	M6	M10x1.25	M10	2.6	3.3	6	50	57.5 <sup>+0.5</sup>
40								6.1	51.1	58.6 <sup>+0.6</sup>
50								8.2	53.2	62.8 <sup>+0.6</sup>
63	3.5	M10	M8	M12x1.25	M12	3.3	4.7	8.1	57.1	66.6 <sup>+0.6</sup>
80								8.9	62.9	73.2 <sup>+0.6</sup>
100								9	76	86.4 <sup>+0.6</sup>
125	–	M16	M12	M20x1.5	M20	6.1	7	11	92	104.4 <sup>+0.6</sup>

# Datasheet

**Dimensions – Variants**

Download CAD data → [www.festo.com](http://www.festo.com)

S1 – Reinforced piston rod

∅ 25

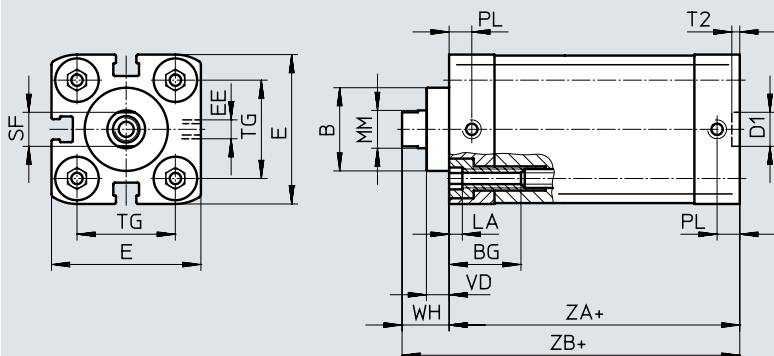

+ = plus stroke length

∅ 40 ... 100

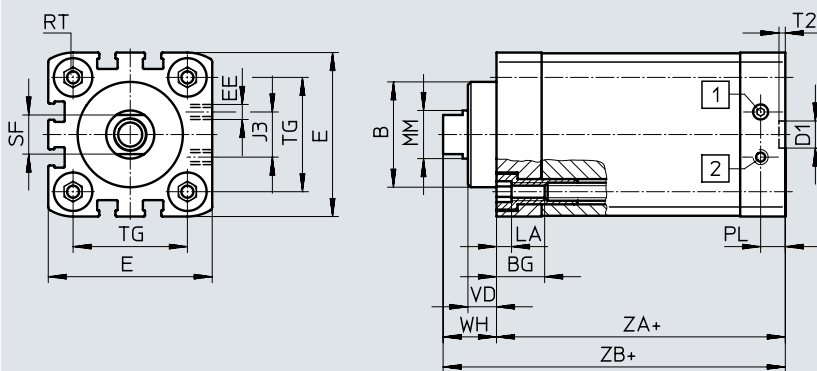

[1] Cylinder extending  
[2] Cylinder retracting

+ = plus stroke length

∅ [mm]	B ∅ f8	BG min.	D1 ∅ H9	E	EE	J3	PW	MM ∅	PL
25	22	15	9	39.5 <sup>+0.3</sup>	M5	–	5	10	6
40	35	16		54.5 <sup>+0.3</sup>		15		16	
63	42		75.5 <sup>+0.3</sup>	23	20	8.2			
100	55	17	12	113.5 <sup>+0.6</sup>	G1/8	40	25	10.5	

∅ [mm]	RT	ST h13	T2	TG	VD	WH	ZA	ZB
25	M5	9	2.1	26	6	11.8	39	50.9
40	M6	13		38	9.5	18	45	62.9
63	M8	17	2.6	56.5	12	21	49	70.2
100	M10	21		89	15.5	26.5	67	93.5

## Datasheet

## Dimensions – Variants

Download CAD data → [www.festo.com](http://www.festo.com)

## S1 – Reinforced piston rod

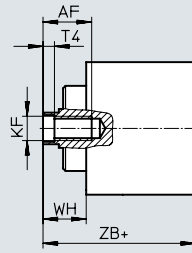
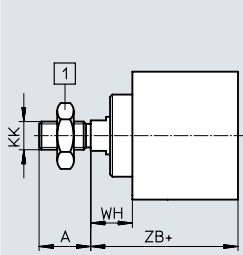

[1] Hex nut DIN 439-B  
only with  $\varnothing 40 \dots 100$

+ = plus stroke length

## S1-K2 – Reinforced piston rod with extended male piston rod thread

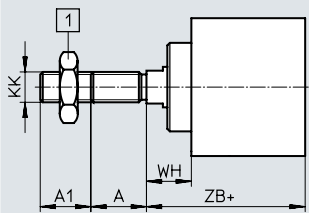

[1] Hex nut DIN 439-B  
only with  $\varnothing 40 \dots 100$

+ = plus stroke length

## S1-K5 – Reinforced piston rod with special piston rod thread

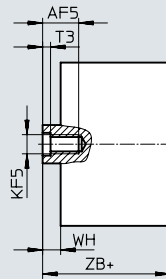
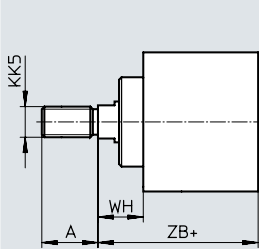

+ = plus stroke length

## S1-K8 – Reinforced piston rod with piston rod extension

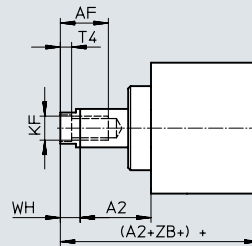
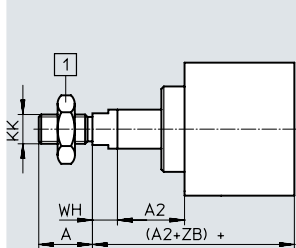

[1] Hex nut DIN 439-B  
only with  $\varnothing 40 \dots 100$

+ = plus stroke length

$\varnothing$ [mm]	A	A1	A2	AF	AF5	KF	KF5	KK	KK5	T3	T4	WH	ZB
25	16	1 ... 20	1 ... 300	14	12	M6	M5	M8	M10x1.25 M10	2	2.6	11.8	50.9
40	22		1 ... 400	20	16	M10	M8	M12x1.25	M10x1.25 M12	3.3	4.7	18	62.9
63	28				20	M12	M10	M16x1.5	M12x1.25 M16	4.7	6.1	21	70.2
100	40	1 ... 30	1 ... 500	25	–	M16	–	M20x1.5	M16x1.5 M20	–	7	26.5	93.5

Datasheet

★ Core Range

Ordering data		Piston diameter [mm]	Stroke [mm]	I – Piston rod with female thread P – Elastic cushioning rings/plates both ends		A – Piston rod with male thread P – Elastic cushioning rings/plates both ends	
Type	at			Part no.	Type	Part no.	Type
	12	5	★ 536211	ADN-12-5-I-P-A	★ 536204	ADN-12-5-A-P-A	
		10	★ 536212	ADN-12-10-I-P-A	★ 536205	ADN-12-10-A-P-A	
		15	★ 536213	ADN-12-15-I-P-A	★ 536206	ADN-12-15-A-P-A	
		20	★ 536214	ADN-12-20-I-P-A	★ 536207	ADN-12-20-A-P-A	
		25	★ 536215	ADN-12-25-I-P-A	★ 536208	ADN-12-25-A-P-A	
		30	★ 536216	ADN-12-30-I-P-A	★ 536209	ADN-12-30-A-P-A	
		40	★ 536217	ADN-12-40-I-P-A	★ 536210	ADN-12-40-A-P-A	
	16	5	★ 536226	ADN-16-5-I-P-A	★ 536219	ADN-16-5-A-P-A	
		10	★ 536227	ADN-16-10-I-P-A	★ 536220	ADN-16-10-A-P-A	
		15	★ 536228	ADN-16-15-I-P-A	★ 536221	ADN-16-15-A-P-A	
		20	★ 536229	ADN-16-20-I-P-A	★ 536222	ADN-16-20-A-P-A	
		25	★ 536230	ADN-16-25-I-P-A	★ 536223	ADN-16-25-A-P-A	
		30	★ 536231	ADN-16-30-I-P-A	★ 536224	ADN-16-30-A-P-A	
		40	★ 536232	ADN-16-40-I-P-A	★ 536225	ADN-16-40-A-P-A	
	20	5	★ 536242	ADN-20-5-I-P-A	★ 536234	ADN-20-5-A-P-A	
		10	★ 536243	ADN-20-10-I-P-A	★ 536235	ADN-20-10-A-P-A	
		15	★ 536244	ADN-20-15-I-P-A	★ 536236	ADN-20-15-A-P-A	
		20	★ 536245	ADN-20-20-I-P-A	★ 536237	ADN-20-20-A-P-A	
		25	★ 536246	ADN-20-25-I-P-A	★ 536238	ADN-20-25-A-P-A	
		30	★ 536247	ADN-20-30-I-P-A	★ 536239	ADN-20-30-A-P-A	
		40	★ 536248	ADN-20-40-I-P-A	★ 536240	ADN-20-40-A-P-A	
	25	5	★ 536259	ADN-25-5-I-P-A	★ 536251	ADN-25-5-A-P-A	
		10	★ 536260	ADN-25-10-I-P-A	★ 536252	ADN-25-10-A-P-A	
		15	★ 536261	ADN-25-15-I-P-A	★ 536253	ADN-25-15-A-P-A	
		20	★ 536262	ADN-25-20-I-P-A	★ 536254	ADN-25-20-A-P-A	
		25	★ 536263	ADN-25-25-I-P-A	★ 536255	ADN-25-25-A-P-A	
		30	★ 536264	ADN-25-30-I-P-A	★ 536256	ADN-25-30-A-P-A	
		40	★ 536265	ADN-25-40-I-P-A	★ 536257	ADN-25-40-A-P-A	
32	5	★ 536278	ADN-32-5-I-P-A	★ 536268	ADN-32-5-A-P-A		
	10	★ 536279	ADN-32-10-I-P-A	★ 536269	ADN-32-10-A-P-A		
	15	★ 536280	ADN-32-15-I-P-A	★ 536270	ADN-32-15-A-P-A		
	20	★ 536281	ADN-32-20-I-P-A	★ 536271	ADN-32-20-A-P-A		
	25	★ 536282	ADN-32-25-I-P-A	★ 536272	ADN-32-25-A-P-A		
	30	★ 536283	ADN-32-30-I-P-A	★ 536273	ADN-32-30-A-P-A		
	40	★ 536284	ADN-32-40-I-P-A	★ 536274	ADN-32-40-A-P-A		
32	50	★ 536285	ADN-32-50-I-P-A	★ 536275	ADN-32-50-A-P-A		
	60	★ 536286	ADN-32-60-I-P-A	★ 536276	ADN-32-60-A-P-A		
	80	★ 536287	ADN-32-80-I-P-A	★ 536277	ADN-32-80-A-P-A		

## Datasheet

## ★ Core Range

Ordering data		Piston diameter [mm]	Stroke [mm]	I – Piston rod with female thread P – Elastic cushioning rings/plates both ends		A – Piston rod with male thread P – Elastic cushioning rings/plates both ends	
Type	at			Part no.	Type	Part no.	Type
	40	5	★ 536299	ADN-40-5-I-P-A	★ 536289	ADN-40-5-A-P-A	
		10	★ 536300	ADN-40-10-I-P-A	★ 536290	ADN-40-10-A-P-A	
		15	★ 536301	ADN-40-15-I-P-A	★ 536291	ADN-40-15-A-P-A	
		20	★ 536302	ADN-40-20-I-P-A	★ 536292	ADN-40-20-A-P-A	
		25	★ 536303	ADN-40-25-I-P-A	★ 536293	ADN-40-25-A-P-A	
		30	★ 536304	ADN-40-30-I-P-A	★ 536294	ADN-40-30-A-P-A	
		40	★ 536305	ADN-40-40-I-P-A	★ 536295	ADN-40-40-A-P-A	
		50	★ 536306	ADN-40-50-I-P-A	★ 536296	ADN-40-50-A-P-A	
	60	★ 536307	ADN-40-60-I-P-A	★ 536297	ADN-40-60-A-P-A		
	80	★ 536308	ADN-40-80-I-P-A	★ 536298	ADN-40-80-A-P-A		
	50	5	★ 536320	ADN-50-5-I-P-A	★ 536310	ADN-50-5-A-P-A	
		10	★ 536321	ADN-50-10-I-P-A	★ 536311	ADN-50-10-A-P-A	
		15	★ 536322	ADN-50-15-I-P-A	★ 536312	ADN-50-15-A-P-A	
		20	★ 536323	ADN-50-20-I-P-A	★ 536313	ADN-50-20-A-P-A	
		25	★ 536324	ADN-50-25-I-P-A	★ 536314	ADN-50-25-A-P-A	
		30	★ 536325	ADN-50-30-I-P-A	★ 536315	ADN-50-30-A-P-A	
		40	★ 536326	ADN-50-40-I-P-A	★ 536316	ADN-50-40-A-P-A	
		50	★ 536327	ADN-50-50-I-P-A	★ 536317	ADN-50-50-A-P-A	
		60	★ 536328	ADN-50-60-I-P-A	★ 536318	ADN-50-60-A-P-A	
		80	★ 536329	ADN-50-80-I-P-A	★ 536319	ADN-50-80-A-P-A	
	63	10	★ 536342	ADN-63-10-I-P-A	★ 536332	ADN-63-10-A-P-A	
		15	★ 536343	ADN-63-15-I-P-A	★ 536333	ADN-63-15-A-P-A	
		20	★ 536344	ADN-63-20-I-P-A	★ 536334	ADN-63-20-A-P-A	
		25	★ 536345	ADN-63-25-I-P-A	★ 536335	ADN-63-25-A-P-A	
		30	★ 536346	ADN-63-30-I-P-A	★ 536336	ADN-63-30-A-P-A	
		40	★ 536347	ADN-63-40-I-P-A	★ 536337	ADN-63-40-A-P-A	
		50	★ 536348	ADN-63-50-I-P-A	★ 536338	ADN-63-50-A-P-A	
		60	★ 536349	ADN-63-60-I-P-A	★ 536339	ADN-63-60-A-P-A	
		80	★ 536350	ADN-63-80-I-P-A	★ 536340	ADN-63-80-A-P-A	
		80	10	★ 536363	ADN-80-10-I-P-A	★ 536353	ADN-80-10-A-P-A
	15		★ 536364	ADN-80-15-I-P-A	★ 536354	ADN-80-15-A-P-A	
	20		★ 536365	ADN-80-20-I-P-A	★ 536355	ADN-80-20-A-P-A	
25	★ 536366		ADN-80-25-I-P-A	★ 536356	ADN-80-25-A-P-A		
30	★ 536367		ADN-80-30-I-P-A	★ 536357	ADN-80-30-A-P-A		
40	★ 536368		ADN-80-40-I-P-A	★ 536358	ADN-80-40-A-P-A		
50	★ 536369		ADN-80-50-I-P-A	★ 536359	ADN-80-50-A-P-A		
60	★ 536370		ADN-80-60-I-P-A	★ 536360	ADN-80-60-A-P-A		
80	★ 536371		ADN-80-80-I-P-A	★ 536361	ADN-80-80-A-P-A		

## Datasheet

### ★ Core Range

Ordering data		Piston diameter [mm]	Stroke [mm]	I – Piston rod with female thread		A – Piston rod with male thread	
Type	PPS – Pneumatic cushioning, self-adjusting at both ends			PPS – Pneumatic cushioning, self-adjusting at both ends			
	Part no.			Type	Part no.	Type	
	32	10	★ 572646	ADN-32-10-I-PPS-A	★ 572655	ADN-32-10-A-PPS-A	
		15	★ 572647	ADN-32-15-I-PPS-A	★ 572656	ADN-32-15-A-PPS-A	
		20	★ 572648	ADN-32-20-I-PPS-A	★ 572657	ADN-32-20-A-PPS-A	
		25	★ 572649	ADN-32-25-I-PPS-A	★ 572658	ADN-32-25-A-PPS-A	
		30	★ 572650	ADN-32-30-I-PPS-A	★ 572659	ADN-32-30-A-PPS-A	
		40	★ 572651	ADN-32-40-I-PPS-A	★ 572660	ADN-32-40-A-PPS-A	
		50	★ 572652	ADN-32-50-I-PPS-A	★ 572661	ADN-32-50-A-PPS-A	
		60	★ 572653	ADN-32-60-I-PPS-A	★ 572662	ADN-32-60-A-PPS-A	
		80	★ 572654	ADN-32-80-I-PPS-A	★ 572663	ADN-32-80-A-PPS-A	
	40	10	★ 572664	ADN-40-10-I-PPS-A	★ 572673	ADN-40-10-A-PPS-A	
		15	★ 572665	ADN-40-15-I-PPS-A	★ 572674	ADN-40-15-A-PPS-A	
		20	★ 572666	ADN-40-20-I-PPS-A	★ 572675	ADN-40-20-A-PPS-A	
		25	★ 572667	ADN-40-25-I-PPS-A	★ 572676	ADN-40-25-A-PPS-A	
		30	★ 572668	ADN-40-30-I-PPS-A	★ 572677	ADN-40-30-A-PPS-A	
		40	★ 572669	ADN-40-40-I-PPS-A	★ 572678	ADN-40-40-A-PPS-A	
		50	★ 572670	ADN-40-50-I-PPS-A	★ 572679	ADN-40-50-A-PPS-A	
		60	★ 572671	ADN-40-60-I-PPS-A	★ 572680	ADN-40-60-A-PPS-A	
		80	★ 572672	ADN-40-80-I-PPS-A	★ 572681	ADN-40-80-A-PPS-A	
	50	10	★ 572682	ADN-50-10-I-PPS-A	★ 572691	ADN-50-10-A-PPS-A	
		15	★ 572683	ADN-50-15-I-PPS-A	★ 572692	ADN-50-15-A-PPS-A	
		20	★ 572684	ADN-50-20-I-PPS-A	★ 572693	ADN-50-20-A-PPS-A	
		25	★ 572685	ADN-50-25-I-PPS-A	★ 572694	ADN-50-25-A-PPS-A	
		30	★ 572686	ADN-50-30-I-PPS-A	★ 572695	ADN-50-30-A-PPS-A	
		40	★ 572687	ADN-50-40-I-PPS-A	★ 572696	ADN-50-40-A-PPS-A	
		50	★ 572688	ADN-50-50-I-PPS-A	★ 572697	ADN-50-50-A-PPS-A	
		60	★ 572689	ADN-50-60-I-PPS-A	★ 572698	ADN-50-60-A-PPS-A	
		80	★ 572690	ADN-50-80-I-PPS-A	★ 572699	ADN-50-80-A-PPS-A	

## Datasheet

## ★ Core Range

Ordering data Type	Piston diameter [mm]	Stroke [mm]	I – Piston rod with female thread		A – Piston rod with male thread	
			PPS – Pneumatic cushioning, self-adjusting at both ends		PPS – Pneumatic cushioning, self-adjusting at both ends	
			Part no.	Type	Part no.	Type
	63	10	★ 572700	ADN-63-10-I-PPS-A	★ 572709	ADN-63-10-A-PPS-A
		15	★ 572701	ADN-63-15-I-PPS-A	★ 572710	ADN-63-15-A-PPS-A
		20	★ 572702	ADN-63-20-I-PPS-A	★ 572711	ADN-63-20-A-PPS-A
		25	★ 572703	ADN-63-25-I-PPS-A	★ 572712	ADN-63-25-A-PPS-A
		30	★ 572704	ADN-63-30-I-PPS-A	★ 572713	ADN-63-30-A-PPS-A
		40	★ 572705	ADN-63-40-I-PPS-A	★ 572714	ADN-63-40-A-PPS-A
		50	★ 572706	ADN-63-50-I-PPS-A	★ 572715	ADN-63-50-A-PPS-A
		60	★ 572707	ADN-63-60-I-PPS-A	★ 572716	ADN-63-60-A-PPS-A
	80	★ 572708	ADN-63-80-I-PPS-A	★ 572717	ADN-63-80-A-PPS-A	
	80	10	★ 572718	ADN-80-10-I-PPS-A	★ 572727	ADN-80-10-A-PPS-A
		15	★ 572719	ADN-80-15-I-PPS-A	★ 572728	ADN-80-15-A-PPS-A
		20	★ 572720	ADN-80-20-I-PPS-A	★ 572729	ADN-80-20-A-PPS-A
		25	★ 572721	ADN-80-25-I-PPS-A	★ 572730	ADN-80-25-A-PPS-A
		30	★ 572722	ADN-80-30-I-PPS-A	★ 572731	ADN-80-30-A-PPS-A
		40	★ 572723	ADN-80-40-I-PPS-A	★ 572732	ADN-80-40-A-PPS-A
		50	★ 572724	ADN-80-50-I-PPS-A	★ 572733	ADN-80-50-A-PPS-A
60		★ 572725	ADN-80-60-I-PPS-A	★ 572734	ADN-80-60-A-PPS-A	
80	★ 572726	ADN-80-80-I-PPS-A	★ 572735	ADN-80-80-A-PPS-A		

## Datasheet

Ordering data Type	Piston diameter [mm]	Stroke [mm]	I – Piston rod with female thread		A – Piston rod with male thread	
			P – Elastic cushioning rings/plates both ends		P – Elastic cushioning rings/plates both ends	
			Part no.	Type	Part no.	Type
	12	35	8178328	ADN-12-35-I-P-A	8178327	ADN-12-35-A-P-A
		50	8178550	ADN-12-50-I-P-A	8178548	ADN-12-50-A-P-A
		60	604883	ADN-12-60-I-P-A	8178549	ADN-12-60-A-P-A
	16	35	8178765	ADN-16-35-I-P-A	8178762	ADN-16-35-A-P-A
		60	8178766	ADN-16-60-I-P-A	8178763	ADN-16-60-A-P-A
		70	8178767	ADN-16-70-I-P-A	594950	ADN-16-70-A-P-A
	20	35	578011	ADN-20-35-I-P-A	8178859	ADN-20-35-A-P-A
		70	8178862	ADN-20-70-I-P-A	595275	ADN-20-70-A-P-A
	25	35	608920	ADN-25-35-I-P-A	574647	ADN-25-35-A-P-A
		70	8178880	ADN-25-70-I-P-A	8178877	ADN-25-70-A-P-A
		80	578450	ADN-25-80-I-P-A	576652	ADN-25-80-A-P-A
	32	35	8179019	ADN-32-35-I-P-A	576645	ADN-32-35-A-P-A
		70	8173462	ADN-32-70-I-P-A	564092	ADN-32-70-A-P-A
	40	35	8179033	ADN-40-35-I-P-A	8179031	ADN-40-35-A-P-A
		70	8179034	ADN-40-70-I-P-A	582549	ADN-40-70-A-P-A
	50	35	8178619	ADN-50-35-I-P-A	8178336	ADN-50-35-A-P-A
		70	8178338	ADN-50-70-I-P-A	572851	ADN-50-70-A-P-A
	63	35	8178659	ADN-63-35-I-P-A	8178283	ADN-63-35-A-P-A
		70	8178285	ADN-63-70-I-P-A	8178284	ADN-63-70-A-P-A
	100	10	536384	ADN-100-10-I-P-A	536374	ADN-100-10-A-P-A
		15	536385	ADN-100-15-I-P-A	536375	ADN-100-15-A-P-A
		20	536386	ADN-100-20-I-P-A	536376	ADN-100-20-A-P-A
		25	536387	ADN-100-25-I-P-A	536377	ADN-100-25-A-P-A
		30	536388	ADN-100-30-I-P-A	536378	ADN-100-30-A-P-A
40		536389	ADN-100-40-I-P-A	536379	ADN-100-40-A-P-A	
50		536390	ADN-100-50-I-P-A	536380	ADN-100-50-A-P-A	
60		536391	ADN-100-60-I-P-A	536381	ADN-100-60-A-P-A	
	80	536392	ADN-100-80-I-P-A	536382	ADN-100-80-A-P-A	



## Datasheet

Ordering data Type	Piston diameter [mm]	Stroke [mm]	I – Piston rod with female thread PPS – Pneumatic cushioning, self-adjusting at both ends		A – Piston rod with male thread PPS – Pneumatic cushioning, self-adjusting at both ends	
			Part no.	Type	Part no.	Type
				20	10	577158
		15	577159	ADN-20-15-I-PPS-A	577167	ADN-20-15-A-PPS-A
		20	577160	ADN-20-20-I-PPS-A	577168	ADN-20-20-A-PPS-A
		25	577161	ADN-20-25-I-PPS-A	577169	ADN-20-25-A-PPS-A
		30	577162	ADN-20-30-I-PPS-A	577170	ADN-20-30-A-PPS-A
		35	8178865	ADN-20-35-I-PPS-A	8178863	ADN-20-35-A-PPS-A
		40	577163	ADN-20-40-I-PPS-A	577171	ADN-20-40-A-PPS-A
		50	577164	ADN-20-50-I-PPS-A	577172	ADN-20-50-A-PPS-A
		60	577165	ADN-20-60-I-PPS-A	577173	ADN-20-60-A-PPS-A
		70	8178866	ADN-20-70-I-PPS-A	593451	ADN-20-70-A-PPS-A
	25	10	577174	ADN-25-10-I-PPS-A	577182	ADN-25-10-A-PPS-A
		15	577175	ADN-25-15-I-PPS-A	577183	ADN-25-15-A-PPS-A
		20	577176	ADN-25-20-I-PPS-A	577184	ADN-25-20-A-PPS-A
		25	577177	ADN-25-25-I-PPS-A	577185	ADN-25-25-A-PPS-A
		30	577178	ADN-25-30-I-PPS-A	577186	ADN-25-30-A-PPS-A
		35	8178885	ADN-25-35-I-PPS-A	8178882	ADN-25-35-A-PPS-A
		40	577179	ADN-25-40-I-PPS-A	577187	ADN-25-40-A-PPS-A
		50	577180	ADN-25-50-I-PPS-A	577188	ADN-25-50-A-PPS-A
		60	577181	ADN-25-60-I-PPS-A	577189	ADN-25-60-A-PPS-A
		70	8178886	ADN-25-70-I-PPS-A	8178883	ADN-25-70-A-PPS-A
		80	8178887	ADN-25-80-I-PPS-A	8178884	ADN-25-80-A-PPS-A
	32	35	8179023	ADN-32-35-I-PPS-A	8179021	ADN-32-35-A-PPS-A
		70	8179024	ADN-32-70-I-PPS-A	8179022	ADN-32-70-A-PPS-A
	40	35	8179037	ADN-40-35-I-PPS-A	8179035	ADN-40-35-A-PPS-A
		70	8179038	ADN-40-70-I-PPS-A	8179036	ADN-40-70-A-PPS-A
	50	35	8178620	ADN-50-35-I-PPS-A	8178339	ADN-50-35-A-PPS-A
		70	8178341	ADN-50-70-I-PPS-A	8178340	ADN-50-70-A-PPS-A
	63	35	609539	ADN-63-35-I-PPS-A	610152	ADN-63-35-A-PPS-A
		70	609538	ADN-63-70-I-PPS-A	8178287	ADN-63-70-A-PPS-A
	100	15	577191	ADN-100-15-I-PPS-A	577200	ADN-100-15-A-PPS-A
		20	577192	ADN-100-20-I-PPS-A	577201	ADN-100-20-A-PPS-A
		25	577193	ADN-100-25-I-PPS-A	577202	ADN-100-25-A-PPS-A
		30	577194	ADN-100-30-I-PPS-A	577203	ADN-100-30-A-PPS-A
		40	577195	ADN-100-40-I-PPS-A	577204	ADN-100-40-A-PPS-A
		50	577196	ADN-100-50-I-PPS-A	577205	ADN-100-50-A-PPS-A
		60	577197	ADN-100-60-I-PPS-A	577206	ADN-100-60-A-PPS-A
		80	577198	ADN-100-80-I-PPS-A	577207	ADN-100-80-A-PPS-A

Ordering data – Modular product system, basic version and variants

Ordering table									
Size	12	16	20	25	32	40	Conditions	Code	Enter code
Module no.	<b>536203</b>	<b>536218</b>	<b>536233</b>	<b>536250</b>	<b>536267</b>	<b>536288</b>			
Function	Compact cylinder, double-acting							<b>ADN</b>	ADN
Standard	Based on ISO 21287		Conforms to ISO 21287						
Piston diameter [mm]	12	16	20	25	32	40		★ -...	
Stroke [mm]	1 ... 300				1 ... 400		[10]	★ -...	
Piston rod thread	Male thread							★ -A	
	Female thread						[1]	★ -I	
Cushioning	Elastic cushioning rings/plates at both ends							★ -P	
	-		Pneumatic cushioning, self-adjusting at both ends				[8]	★ -PPS	
Position sensing	Via proximity switch							★ -A	-A

[1] **I** Not with piston rod type S20.  
Not with extended male thread K2

[8] **PPS** Not with improved running performance K10, temperature resistance S6, low temperature TT, scraper R8  
Minimum stroke 5 mm

[10] **Stroke** Minimum stroke 5 mm with a combination of piston rod thread I and piston rod type S2

## Ordering data – Modular product system, basic version and variants

Ordering table									
Size	12	16	20	25	32	40	Conditions	Code	Enter code
Piston rod type	Through piston rod						[2]	★ -S2	
	-	Through, hollow piston rod				1 ... 400		[2]	-S20
[mm]									
Extended male thread	Extended male piston rod thread								
	1 ... 10			1 ... 20				-...K2	
Special piston rod thread	Male thread	M6	M8	M10x1.25	M10x1.25	M10	M10	-“...”K5	
	Female thread	-	-	M5	M5	M6	M6		
Extended piston rod	Extended piston rod								
	[mm]	1 ... 300				1 ... 400		[3]	★ -...K8
Improved running performance	-	-	Smooth anodised aluminium piston rod				[4]	-K10	
Temperature resistance	Heat-resistant seals max. 120 °C							★ -S6	
Corrosion protection	High corrosion protection						[5]	★ -R3	
Captive rating plate	Laser-etched rating plate							-TL	
Low temperature	[°C]	-	-	-40 ... +80			[6] [7]	-TT	
Scraper	-	-	Dust protection				[6]	-R8	
Special material properties	None								
	Recommended for production systems for manufacturing lithium-ion batteries						[9]	-F1A	

[2] **S2, S20** Not with improved running performance K10.  
Not with corrosion protection R3.  
Not with scraper R8

[3] **K8** The sum of the stroke length and piston rod extension must not exceed the maximum permissible stroke length

[4] **K10** Not with extended male thread K2.  
Not with special piston rod thread K5.  
Not with corrosion protection R3

[5] **R3** Not with captive rating plate TL  
Not with scraper R8

[6] **TT, R8** Not with improved running performance K10.  
Not with temperature resistance S6

[7] **TT** Not with scraper R8

[9] **F1A** Not with S6, S20, K10, R3, TL, TT, R8, PPS

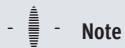
**Note**

NSF-H1 lubricants are used in combination with R3 and in combination with R3 and K2, K5 or K8.

## Ordering data – Modular product system, basic version and variants

Ordering table								
Size	50	63	80	100	125	Conditions	Code	Enter code
Module no.	<b>536309</b>	<b>536330</b>	<b>536351</b>	<b>536372</b>	<b>536393</b>			
Function	Compact cylinder, double-acting						<b>ADN</b>	ADN
Standard	Conforms to ISO 21287				Based on ISO 21287			
Piston diameter [mm]	50	63	80	–	–		★ -...	
	–	–	–	100	125		-...	
Stroke [mm]	1 ... 400		1 ... 500			[10]	★ -...	
Piston rod thread	Male thread						★ -A	
	Female thread					[1]	★ -I	
Cushioning	Elastic cushioning rings/plates at both ends						★ -P	
	Pneumatic cushioning, self-adjusting at both ends				–	[8]	★ -PPS	
Position sensing	Via proximity switch						★ -A	-A

[1] **I** Not with piston rod type S20.  
Not with extended male thread K2

[8] **PPS** Not with improved running performance K10, temperature resistance S6, low temperature TT, scraper R8  
Minimum stroke 5 mm

[10] **Stroke** Minimum stroke 5 mm with a combination of piston rod thread I and piston rod type S2

## Ordering data – Modular product system, basic version and variants

Ordering table		50	63	80	100	125	Conditions	Code	Enter code
Piston rod type		Through piston rod					[2]	★ -S2	
	[mm]	Through, hollow piston rod					[2]	-S20	
Extended male thread	[mm]	Extended male piston rod thread		1 ... 30		1 ... 40		-...K2	
Special piston rod thread	Male thread	M12 M16	M12 M16	M16 M20 M20x1.5	M16 M20 M20x1.5	M20		-“...”K5	
	Female thread	M8	M8	M10	M10	-			
Extended piston rod	[mm]	Extended piston rod		1 ... 500			[3]	★ -...K8	
Improved running performance		Smooth anodised aluminium piston rod					[4]	-K10	
	[mm]	Restricted stroke		2 ... 400   5 ... 400   5 ... 500					
Temperature resistance		Heat-resistant seals max. 120 °C						★ -S6	
Corrosion protection		High corrosion protection					[5]	★ -R3	
Captive rating plate		Laser-etched rating plate						-TL	
Low temperature	[°C]	-40 ... +80				-	[6] [7]	-TT	
Scraper		Dust protection				-	[6]	-R8	
Special material properties		None							
		Recommended for production systems for manufacturing lithium-ion batteries					[9]	-F1A	

- [2] **S2, S20** Not with improved running performance K10.  
Not with corrosion protection R3.  
Not with scraper R8
- [3] **K8** The sum of the stroke length and piston rod extension must not exceed the maximum permissible stroke length
- [4] **K10** Not with extended male thread K2.  
Not with special piston rod thread K5.  
Not with corrosion protection R3
- [5] **R3** Not with captive rating plate TL  
Not with scraper R8
- [6] **TT, R8** Not with improved running performance K10.  
Not with temperature resistance S6
- [7] **TT** Not with scraper R8
- [9] **F1A** Not with S6, S20, K10, R3, TL, TT, R8, PPS

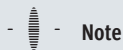
**Note**

NSF-H1 lubricants are used in combination with R3 and in combination with R3 and K2, K5 or K8.

Ordering data – Modular product system, S10 – constant motion, S11 – low friction

Ordering table									
Size	12	16	20	25	32	40	Conditions	Code	Enter code
Module no.	<b>536203</b>	<b>536218</b>	<b>536233</b>	<b>536250</b>	<b>536267</b>	<b>536288</b>			
Function	Compact cylinder, double-acting							<b>ADN</b>	ADN
Standard	Based on ISO 21287		Conforms to ISO 21287						
Piston diameter [mm]	12	16	20	25	32	40		-...	
Stroke [mm]	1 ... 300				1 ... 400			-...	
Piston rod thread	Male thread							<b>-A</b>	
	Female thread						[1]	<b>-I</b>	
Cushioning	Elastic cushioning rings/plates at both ends							<b>-P</b>	-P
Position sensing	Via proximity switch							<b>-A</b>	-A
Extended male thread [mm]	Extended male piston rod thread 1 ... 10		1 ... 20					<b>-...K2</b>	
Special piston rod thread	Male thread	M6	M8	M10x1.25 M10	M10x1.25 M10	M10 M12	M10 M12	<b>-“...”K5</b>	
	Female thread	-	-	M5	M5	M6	M6		
Extended piston rod [mm]	Extended piston rod 1 ... 300				1 ... 400		[2]	<b>-...K8</b>	
Improved running performance	-	-	Smooth anodised aluminium piston rod				[3]	<b>-K10</b>	
Constant motion [mm]	Slow speed (constant motion at low piston speeds) Restricted stroke 20 ... 300						[4]	<b>-S10</b>	
Low friction	Low friction						[5]	<b>-S11</b>	
Corrosion protection	High corrosion protection						[6]	<b>-R3</b>	
Captive rating plate	Laser-etched rating plate							<b>-TL</b>	

- [1] **I** Not with extended male thread K2
- [2] **K8** The sum of the stroke length and piston rod extension must not exceed the maximum permissible stroke length
- [3] **K10** Not with extended male thread K2  
Not with special piston rod thread K5  
Not with corrosion protection R3
- [4] **S10** Not with low friction S11
- [5] **S11** Not with constant motion S10
- [6] **R3** Not with captive rating plate TL



**Note**

NSF-H1 lubricants are used in combination with R3 and in combination with R3 and K2, K5 or K8.

## Ordering data – Modular product system, S10 – constant motion, S11 – low friction

Ordering table									
Size	50	63	80	100	125	Conditions	Code	Enter code	
Module no.	<b>536309</b>	<b>536330</b>	<b>536351</b>	<b>536372</b>	<b>536393</b>				
Function	Compact cylinder, double-acting						<b>ADN</b>	ADN	
Standard	Conforms to ISO 21287				Based on ISO 21287				
Piston diameter [mm]	50	63	80	100	125		-...		
Stroke [mm]	1 ... 400		1 ... 500				-...		
Piston rod thread	Male thread						<b>-A</b>		
	Female thread					[1]	<b>-I</b>		
Cushioning	Elastic cushioning rings/plates at both ends						<b>-P</b>	-P	
Position sensing	Via proximity switch						<b>-A</b>	-A	
Extended male thread [mm]	Extended male piston rod thread 1 ... 20		1 ... 30		1 ... 40		<b>-...K2</b>		
Special piston rod thread	Male thread	M12	M12	M16	M16	M20	<b>-“...”K5</b>		
		M16	M16	M20	M20	M20x1.5			
	Female thread	M8	M8	M10	M10	-			
Extended piston rod [mm]	Extended piston rod 1 ... 400		1 ... 500			[2]	<b>-...K8</b>		
Improved running performance [mm]	Smooth anodised aluminium piston rod					[3]	<b>-K10</b>		
	Restricted stroke 2 ... 400   5 ... 400   5 ... 500								
Constant motion [mm]	Slow speed (constant motion at low piston speeds)					[4]	<b>-S10</b>		
	Restricted stroke 20 ... 400			20 ... 500					
Low friction	Low friction					[5]	<b>-S11</b>		
Corrosion protection	High corrosion protection					[6]	<b>-R3</b>		
Captive rating plate	Laser-etched rating plate						<b>-TL</b>		

- [1] **I** Not with extended male thread K2
- [2] **K8** The sum of the stroke length and piston rod extension must not exceed the maximum permissible stroke length
- [3] **K10** Not with extended male thread K2  
Not with special piston rod thread K5  
Not with corrosion protection R3
- [4] **S10** Not with low friction S11
- [5] **S11** Not with constant motion S10
- [6] **R3** Not with captive rating plate TL

 **Note**

NSF-H1 lubricants are used in combination with R3 and in combination with R3 and K2, K5 or K8.

## Ordering data – Modular product system, Q – Square piston rod, non-rotating

Ordering table								Conditions	Code	Enter code
Size	12	16	20	25	32	40				
Module no.	<b>536203</b>	<b>536218</b>	<b>536233</b>	<b>536250</b>	<b>536267</b>	<b>536288</b>				
Function	Compact cylinder, double-acting							<b>ADN</b>	ADN	
Standard	Based on ISO 21287		Conforms to ISO 21287							
Piston diameter [mm]	12	16	20	25	32	40		★ -...		
Stroke [mm]	1 ... 300				1 ... 400		[10]	★ -...		
Piston rod thread	Male thread							★ -A		
	Female thread						[1]	★ -I		
Cushioning	Elastic cushioning rings/plates at both ends							★ -P	-P	
Position sensing	Via proximity switch							★ -A	-A	
Protection against rotation	Square piston rod							★ -Q	-Q	
Piston rod type	Through piston rod							★ -S2		
	-	Through, hollow piston rod Restricted stroke 1 ... 200				1 ... 300			-S20	
Extended male thread [mm]	Extended male piston rod thread 1 ... 10		1 ... 20					-...K2		
Special piston rod thread Male thread	M6	M8	M10x1.25 M10	M10x1.25 M10	M10	M10		-“...”K5		
Extended piston rod [mm]	Extended piston rod 1 ... 300				1 ... 400		[2]	★ -...K8		
Temperature resistance	Heat-resistant seals max. 120 °C							★ -S6		
Corrosion protection	High corrosion protection						[3]	★ -R3		
Captive rating plate	Laser-etched rating plate							-TL		

[1] **I** Not with piston rod type S20.  
Not with extended male thread K2

[2] **K8** The sum of the stroke length and piston rod extension must not exceed the maximum permissible stroke length

[3] **R3** Not with captive rating plate TL

[10] **Stroke** Minimum stroke 5 mm with a combination of piston rod thread I and piston rod type S2

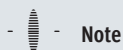
**Note**

NSF-H1 lubricants are used in combination with R3 and in combination with R3 and K2, K5 or K8.



## Ordering data – Modular product system, Q – Square piston rod, non-rotating

Ordering table									
Size	50	63	80	100	125	Conditions	Code	Enter code	
Module no.	<b>536309</b>	<b>536330</b>	<b>536351</b>	<b>536372</b>	<b>536393</b>				
Function	Compact cylinder, double-acting						<b>ADN</b>	ADN	
Standard	Conforms to ISO 21287				Based on ISO 21287				
Piston diameter [mm]	50	63	80	100	125		★ -...		
Stroke [mm]	1 ... 400		1 ... 500				★ -...		
Piston rod thread	Male thread						★ -A		
	Female thread					[1]	★ -I		
Cushioning	Elastic cushioning rings/plates at both ends						★ -P	-P	
Position sensing	Via proximity switch						★ -A	-A	
Protection against rotation	Square piston rod						★ -Q	-Q	
Piston rod type	Through piston rod						★ -S2		
	Through, hollow piston rod						-S20		
	Restricted stroke [mm]	1 ... 300		1 ... 400					
Extended male thread [mm]	Extended male piston rod thread								
	1 ... 20		1 ... 30		1 ... 40		-...K2		
Special piston rod thread Male thread	M12	M12	M16	M16	M20		-“...”K5		
Extended piston rod [mm]	Extended piston rod		1 ... 500			[2]	★ -...K8		
Temperature resistance	Heat-resistant seals max. 120 °C						★ -S6		
Corrosion protection	High corrosion protection					[3]	★ -R3		
Captive rating plate	Laser-etched rating plate						-TL		

[1] **I** Not with piston rod type S20.  
Not with extended male thread K2

[2] **K8** The sum of the stroke length and piston rod extension must not exceed the maximum permissible stroke length

[3] **R3** Not with captive rating plate TL

**Note**

NSF-H1 lubricants are used in combination with R3 and in combination with R3 and K2, K5 or K8.

## Ordering data – Modular product system, S1 – Reinforced piston rod

Ordering table							
Size	25	40	63	100	Conditions	Code	Enter code
Module no.	<b>536250</b>	<b>536288</b>	<b>536330</b>	<b>536372</b>			
Function	Compact cylinder, double-acting					<b>ADN</b>	ADN
Standard	Conforms to ISO 21287						
Piston diameter [mm]	25	40	63	100		-...	
Stroke [mm]	5 ... 300	10 ... 400		10 ... 500		-...	
Piston rod thread	Male thread					<b>-A</b>	
	Female thread				[1]	<b>-I</b>	
Cushioning	Elastic cushioning rings/plates at both ends					<b>-P</b>	-P
Position sensing	Via proximity switch					<b>-A</b>	-A
Extended male thread [mm]	Extended male piston rod thread						
	1 ... 20			1 ... 30		<b>-...K2</b>	
Special piston rod thread	Male thread	M10x1.25 M10	M10x1.25 M12	M12x1.25 M16	M16x1.5 M20	<b>-“...”K5</b>	
	Female thread	M5	M8	M10	-		
Extended piston rod [mm]	Extended piston rod						
	1 ... 300	1 ... 400		1 ... 500	[2]	<b>-...K8</b>	
Temperature resistance	Heat-resistant seals max. 120 °C					<b>-S6</b>	
Increased lateral force	Reinforced piston rod or extended piston rod bearing					<b>-S1</b>	-S1
Captive rating plate	Laser-etched rating plate					<b>-TL</b>	

[1] **I** Not with extended male thread K2

[2] **K8** The sum of the stroke length and piston rod extension must not exceed the maximum permissible stroke length

## Type codes

001	Series	
ADN	Compact cylinder, double-acting, based on ISO 21287	

002	Piston diameter	
20	20	
25	25	
32	32	
40	40	
50	50	
63	63	
80	80	
100	100	

003	Stroke	
...	10 ... 500	

004	Clamping unit	
KP	Attached	

005	Piston rod thread type	
A	Male thread	
I	Female thread	

006	Cushioning	
P	Elastic cushioning rings/plates on both sides	

007	Position sensing	
A	For proximity sensor	

008	Piston rod thread extension	
	None	
...K2	1 ... 30 mm	

009	Custom thread	
"M6"K5	M6	
"M8"K5	M8	
"M10"K5	M10	
"M10x-1,25"K5	M10x1.25	
"M12"K5	M12	
"M16"K5	M16	
"M20x-1,5"K5	M20x1.5	
"M5"K5	M5	
"M20"K5	M20	

010	Piston rod extension	
	None	
...K8	1 ... 500 mm	

011	Captive rating plate	
	Rating plate, glued	
TL	Laser etched rating plate	

## Datasheet

### Function

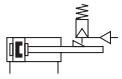

### Variants



K2



K5



K8

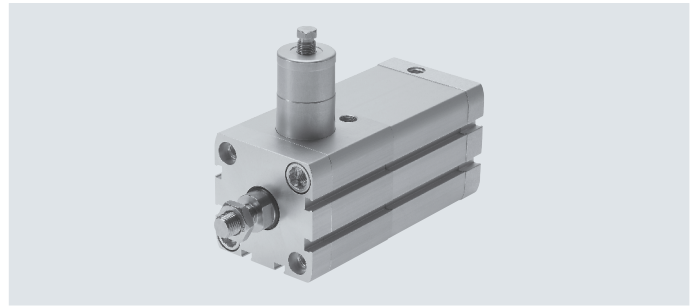

-  Diameter  
20 ... 100 mm

-  Stroke length  
10 ... 500 mm

### Note

Additional measures are required for use in safety-related applications; in Europe, for example, the standards listed under the EC Machinery Directive must be observed.

Without additional measures in accordance with legally specified minimum requirements, the product is not suitable as a safety-related component in control systems.

### General technical data

Piston diameter	20	25	32	40	50	63	80	100
Pneumatic connection								
Cylinders	M5	M5	G1/8	G1/8	G1/8	G1/8	G1/8	G1/8
KP	M5	M5	M5	G1/8	G1/8	G1/8	G1/8	G1/8
Female piston rod thread								
-	M6	M8	M10	M12				
K5	M5	M6	M8	M10				
Male piston rod thread								
-	M8	M10x1.25	M12x1.25	M16x1.5				
K5	M10; M10x1.25	M10; M12	M12; M16	M16; M20; M20x1.5				
Axial backlash under load	[mm]			0.5	0.8			
Design	Piston							
	Piston rod							
	Cylinder barrel							
Cushioning	Elastic cushioning rings/plates at both ends							
Position sensing	Via proximity switch							
Type of mounting	Via through-hole							
	With female thread							
	With accessories							
Mounting position	Any							
Clamping type with operating direction	At both ends							

### Operating and environmental conditions

Operating medium	Compressed air to ISO 8573-1:2010 [7:4:4]							
Note on the operating/pilot medium	Lubricated operation possible (in which case lubricated operation will always be required)							
Operating pressure	[MPa]	0.15 ... 1						
	[bar]	1.5 ... 10						
	[psi]	21.76 ... 145						
Min. release pressure	[MPa]	0.3						
	[bar]	3						
	[psi]	43.5						
Ambient temperature <sup>1)</sup>	[°C]	-10 ... +80						
Corrosion resistance class CRC <sup>2)</sup>	2 - Moderate corrosion stress							

1) Note operating range of proximity switches

2) More information: [www.festo.com/x/topic/crc](http://www.festo.com/x/topic/crc)

## Datasheet

Impact energy [J]								
Piston diameter	20	25	32	40	50	63	80	100
Max. impact energy in the end positions	0.2	0.3	0.4	0.7	1	1.3	1.8	2.5

**Note**

These specifications represent the maximum values that can be achieved. The maximum permissible impact energy must be observed.

Permissible impact speed:

$$V = \sqrt{\frac{2 \times E}{m_1 + m_2}}$$

V Permissible impact speed

E max. impact energy

m1 Moving mass (drive)

m2 Moving payload

Maximum permissible mass:

$$m_2 = \frac{2 \times E}{v^2} - m_1$$

Forces [N]								
Piston diameter	20	25	32	40	50	63	80	100
Theoretical force at 6 bar, advancing	188	295	483	754	1178	1870	3016	4712
Theoretical force at 6 bar, retracting	141	247	415	633	990	1682	2721	4418
Static holding force	350	350	600	1000	1400	2000	5000	5000

**Note.**

The specified holding force refers to a static load. If this value is exceeded, slippage may occur. Dynamic forces occurring during operation must

not exceed the static holding force. The clamping unit is not backlash-free in the clamped condition if varying loads are applied to the piston rod

**Actuation**

The clamping unit may only be released if the forces at the piston have reached equilibrium. Otherwise, there is a risk of accidents due to sudden movement of the piston rod.

Blocking off the compressed air supply at both ends (e.g. with a 5/3-way valve) does not provide any safety.

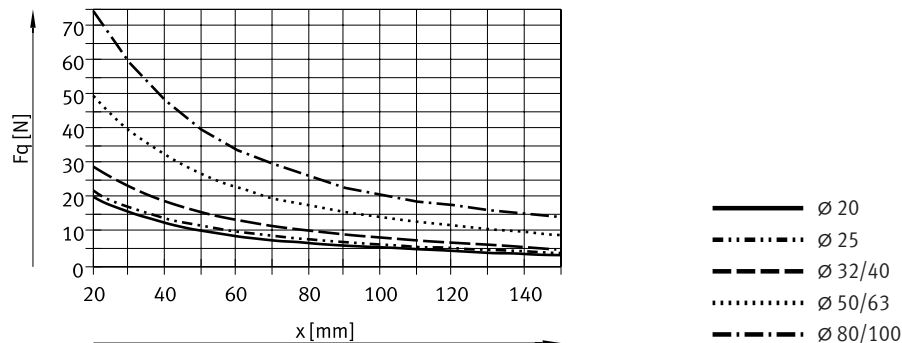
**Max. lateral force F<sub>q</sub> as a function of projection x**

Weight [g]								
Piston diameter	20	25	32	40	50	63	80	100
Product weight with 0 mm stroke	282	344	503	789	1268	1894	3973	5497
Additional weight per 10 mm stroke	22	26	29	45	60	68	93	112
Moving mass with 0 mm stroke	53	63	100	173	296	368	755	932
Additional mass per 10 mm stroke	6	6	9	16	25	25	39	39

## Datasheet

### Materials

Sectional view

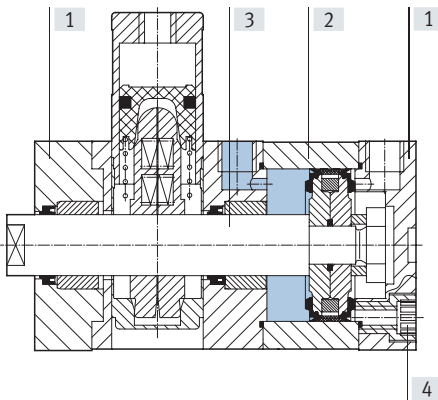

Compact cylinder

[1]	Cover	Anodised aluminium
[2]	Cylinder barrel	Anodised aluminium
[3]	Piston rod	High-alloy steel
[4]	Flange screws	$\varnothing 20 \dots 63$
		$\varnothing 80 \dots 100$
–	Seals	Polyurethane, nitrile rubber
	Note on materials	RoHS-compliant

Datasheet

Dimensions – Basic version

Download CAD data → [www.festo.com](http://www.festo.com)

∅ 20 ... 63

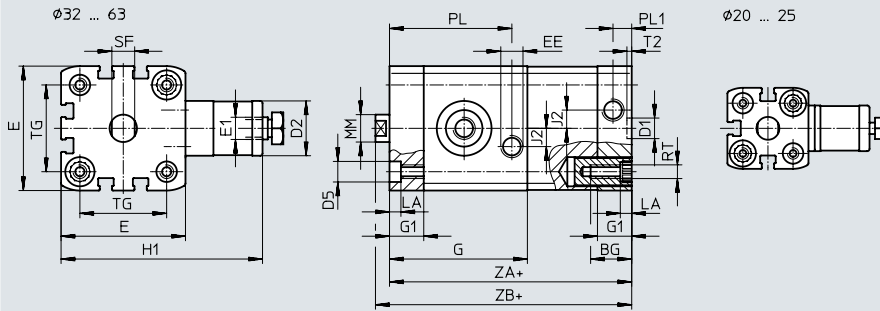

Only direct mounting is possible with this variant.

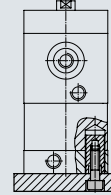

+ = plus stroke length

Dimensions – Basic version

Download CAD data → [www.festo.com](http://www.festo.com)

∅ 80, 100

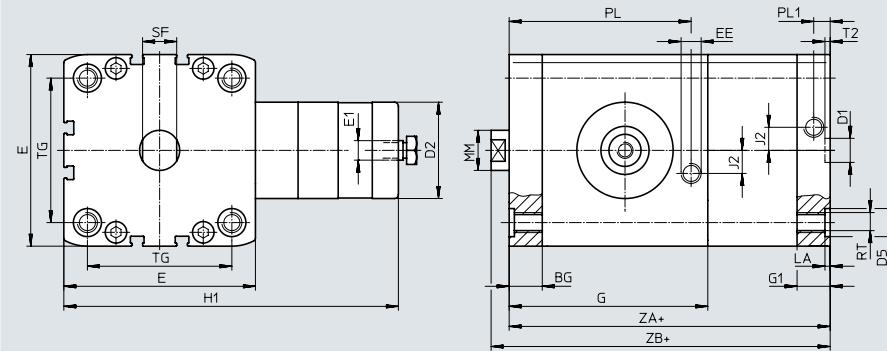

Only direct mounting is possible with this variant.

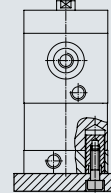

+ = plus stroke length

∅	BG	D1	D2	D5	E	E1	EE	G	G1	H1	J2	
[mm]	min.	∅ H9	∅	∅								
20	19.5	9	20	9 <sup>F9</sup>	35.5 <sup>+0.3</sup>	M5	M5	49.8	12	63	2.6	
25					39.5 <sup>+0.3</sup>			50.6				65
32					47 <sup>+0.3</sup>			56.4				68
40	26	12	24	12 <sup>F9</sup>	54.5 <sup>+0.3</sup>	G1/8	G1/8	60.4	15	89	8	
50					65.5 <sup>+0.3</sup>			67.4		108		
63	27	38	75.5 <sup>+0.3</sup>	76.8	120							
80	17	12	48	15	95.5 <sup>+0.6</sup>	G1/8	G1/8	99	16.5	167	11.5	
100	21.5				113.5 <sup>+0.6</sup>			99.6	21.5	176		20

∅	PW	MM	PL	PL1	RT	ST	T2	TG	ZA	ZB
[mm]	+0.2	∅	+0.2	+0.2		h13	+0.2	±0.2	±0.6	+1.2
20	5	10	42.8	6	M5	9	2.1	22	74.8	80.8
25			44.6					26	77.6	83.1
32			49.6					32.5	85.4	91.4
40		53.6	38	90.4	96.5					
50		20	8.2	60.6	M8	17	2.6	46.5	97.4	105.6
63				70				56.5	110.8	118.9
80	2.6	25	90.7	M10	21	2.6	72	136.5	145.4	
100			88.6				10.5	89	145.1	154.1

## Datasheet

### Dimensions – Variants

Download CAD data → [www.festo.com](http://www.festo.com)

Basic version

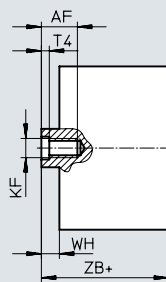
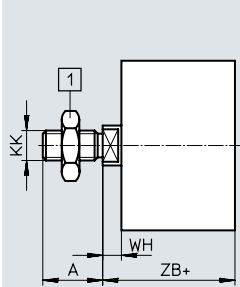

[1] Hex nut DIN 439-B  
only with  $\varnothing 32 \dots 100$

+ = plus stroke length

K2 – Extended male piston rod thread

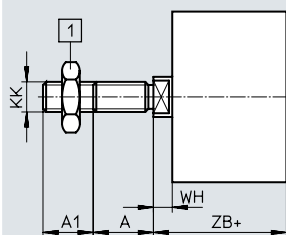

[1] Hex nut DIN 439-B  
only with  $\varnothing 32 \dots 100$

+ = plus stroke length

K5 – Special piston rod thread

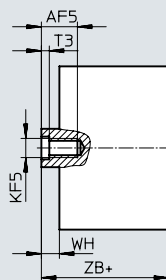
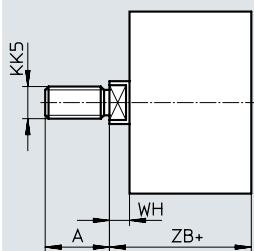

+ = plus stroke length

K8 – Extended piston rod

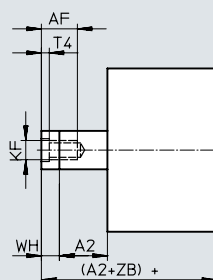
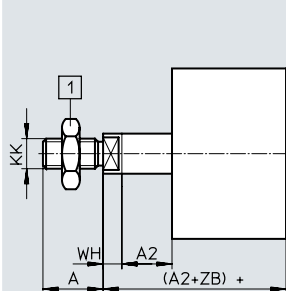

[1] Hex nut DIN 439-B  
only with  $\varnothing 32 \dots 100$

+ = plus stroke length



## Datasheet

∅	A	A1	A2	AF	AF5	KF	KF5
[mm]	-0.5			min.	min.		
20	16	1 ... 20	1 ... 300	14	12	M6	M5
25							
32	19		1 ... 400	16	14	M8	M6
40							
50	22	1 ... 30	1 ... 500	20	16	M10	M8
63							
80	28				20	M12	M10
100							

∅	KK	KK5	T3	T4	WH	ZB
[mm]					+1.3	+1.2
20	M8	M10x1.25 M10	2	2.6	5.5	80.8
25						83.1
32	M10x1.25	M10 M12	2.6	3.3	6	91.4
40						96.5
50	M12x1.25	M12 M16	3.3	4.7	8.2	105.6
63						118.9
80	M16x1.5	M16 M20x1.5 M20	4.7	6.1	8.9	145.4
100						154.1

Compact cylinders ADN-KP, standard hole pattern, with clamping unit

Ordering data – Modular product system

Ordering table							
Size	20	25	32	40	Conditions	Code	Enter code
Module no.	<b>548206</b>	<b>548207</b>	<b>548208</b>	<b>548209</b>			
Function	Compact cylinder, double-acting, standard hole pattern, with clamping unit					<b>ADN</b>	ADN
Piston diameter [mm]	20	25	32	40		-...	
Stroke [mm]	10 ... 300		10 ... 400			-...	
Clamping unit	Attached					<b>-KP</b>	-KP
Piston rod thread	Male thread					<b>-A</b>	
	Female thread				[1]	<b>-I</b>	
Cushioning	Elastic cushioning rings/plates at both ends					<b>-P</b>	-P
Position sensing	Via proximity switch					<b>-A</b>	-A
Extended male thread [mm]	Extended male piston rod thread					<b>-...K2</b>	
	1 ... 20						
Special piston rod thread	Male thread	M10x1.25 M10	M10x1.25 M10	M10 M12	M10 M12	<b>-“...”K5</b>	
	Female thread	M5	M5	M6	M6		
Extended piston rod [mm]	Extended piston rod		1 ... 400		[2]	<b>-...K8</b>	
Captive rating plate	Laser-etched rating plate					<b>-TL</b>	

[1] **I** Not with extended male thread K2

[2] **K8** The sum of the stroke length and piston rod extension must not exceed the maximum permissible stroke length

## Ordering data – Modular product system

Ordering table								Enter code
Size	50	63	80	100	Conditions	Code		
Module no.	<b>548210</b>	<b>548211</b>	<b>548212</b>	<b>548213</b>				
Function	Compact cylinder, double-acting, standard hole pattern, with clamping unit						<b>ADN</b>	ADN
Piston diameter [mm]	50	63	80	100		-...		
Stroke [mm]	10 ... 400		10 ... 500			-...		
Clamping unit	Attached						<b>-KP</b>	-KP
Piston rod thread	Male thread						<b>-A</b>	
	Female thread					[1]	<b>-I</b>	
Cushioning	Elastic cushioning rings/plates at both ends						<b>-P</b>	-P
Position sensing	Via proximity switch						<b>-A</b>	-A
Extended male thread [mm]	Extended male piston rod thread							
	1 ... 20		1 ... 30				<b>-...K2</b>	
Special piston rod thread	Male thread		M12	M12	M16	M16	<b>-“...”K5</b>	
			M16	M16	M20	M20		
	Female thread		M8	M8	M10	M10		
Extended piston rod [mm]	Extended piston rod		1 ... 500			[2]	<b>-...K8</b>	
Captive rating plate	Laser-etched rating plate						<b>-TL</b>	

[1] **I** Not with extended male thread K2

[2] **K8** The sum of the stroke length and piston rod extension must not exceed the maximum permissible stroke length

## Type codes

<b>001</b>	<b>Series</b>	
<b>ADN</b>	Compact cylinder, double-acting, based on ISO 21287	

<b>002</b>	<b>Piston diameter</b>	
<b>20</b>	20	
<b>25</b>	25	
<b>32</b>	32	
<b>40</b>	40	
<b>50</b>	50	
<b>63</b>	63	
<b>80</b>	80	
<b>100</b>	100	

<b>003</b>	<b>Stroke</b>	
<b>...</b>	10 ... 500	

<b>004</b>	<b>End-position locking</b>	
<b>ELB</b>	Both sides	
<b>ELH</b>	Rear	
<b>ELV</b>	Front	

<b>005</b>	<b>Piston rod thread type</b>	
<b>A</b>	Male thread	
<b>I</b>	Female thread	

<b>006</b>	<b>Cushioning</b>	
<b>P</b>	Elastic cushioning rings/plates on both sides	

<b>007</b>	<b>Position sensing</b>	
<b>A</b>	For proximity sensor	

<b>008</b>	<b>Piston rod thread extension</b>	
	None	
<b>...K2</b>	1 ... 30 mm	

<b>009</b>	<b>Custom thread</b>	
<b>"M6"K5</b>	M6	
<b>"M8"K5</b>	M8	
<b>"M10"K5</b>	M10	
<b>"M10x1,25"K5</b>	M10x1.25	
<b>"M12"K5</b>	M12	
<b>"M16"K5</b>	M16	
<b>"M20x1,5"K5</b>	M20x1.5	
<b>"M5"K5</b>	M5	
<b>"M20"K5</b>	M20	

<b>010</b>	<b>Piston rod extension</b>	
	None	
<b>...K8</b>	1 ... 500 mm	

<b>011</b>	<b>Captive rating plate</b>	
	Rating plate, glued	
<b>TL</b>	Laser etched rating plate	

## Datasheet

## Function

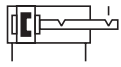

⊘ - Diameter  
 20 ... 100 mm

| - Stroke length  
 10 ... 500 mm

## Variants



K2



K5

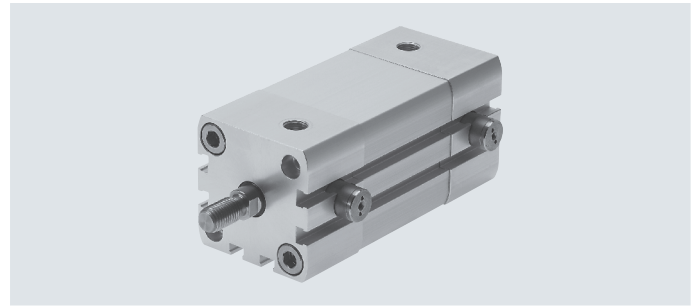

K8

⚠ - **Note**

Additional measures are required for use in safety-related applications; in Europe, for example, the standards listed under the EC Machinery Directive must be observed.

Without additional measures in accordance with legally specified minimum requirements, the product is not suitable as a safety-related component in control systems.

**General technical data**

Piston diameter	20	25	32	40	50	63	80	100
Pneumatic connection	M5	M5	G1/8	G1/8	G1/8	G1/8	G1/8	G1/8
Female piston rod thread								
-	M6	M8		M10		M12		
K5	M5	M6		M8		M10		
Male piston rod thread								
-	M8	M10x1.25		M12x1.25		M16x1.5		
K5	M10; M10x1.25	M10; M12		M12; M16		M16; M20; M20x1.5		
Max. axial backlash with end position locked [mm]	1.3						2.1	
Design	Piston							
	Piston rod							
	Cylinder barrel							
End-position locking								
ELB	At both ends							
ELV	Advanced							
ELH	Rear							
Cushioning	Elastic cushioning rings/plates at both ends							
Position sensing	Via proximity switch							
Type of mounting	With female thread							
	With accessories							
Mounting position	Any							

⚠ - **Note**

- Screws with a head or similar must not be used in place of end-position locking, as there is a risk that the function will be impaired if they are screwed in too deeply.
- The exhaust bore must not be closed.
- The piston rod can be locked in any stroke position once the drive is brought mechanically into its end position.
- End-position locking has been designed to prevent the load from dropping in case of pressure failure.
- Avoid operating the cylinder using a 3-way valve, especially with the function “mid-position closed” and those with “metallic sealing”. The residual pressure that is enclosed on the locking side of the cylinder can release the locking function.
- The cylinder must not be operated with external stops (e.g. shock absorber, buffer, oil brake, etc.):
  - It may not be possible to reliably reach the internal end position.
  - The locking mechanism can wear out prematurely. (If the pressure in the opposite chamber drops to less than the locking pressure, the locking piston will prematurely fall to its lower end position.)

## Datasheet

Operating and environmental conditions								
Piston diameter	20	25	32	40	50	63	80	100
Operating medium	Compressed air to ISO 8573-1:2010 [7:4:4]							
Note on the operating/pilot medium	Lubricated operation possible (in which case lubricated operation will always be required)							
Operating pressure	[MPa]	0.25 ... 1			0.15 ... 1			
	[bar]	2.5 ... 10			1.5 ... 10			
	[psi]	36.26 ... 145			21.76 ... 145			
Ambient temperature <sup>1)</sup>	[°C]	-20 ... +80						
Corrosion resistance class CRC <sup>2)</sup>	2 - Moderate corrosion stress							

- 1) Note operating range of proximity switches  
 2) More information: [www.festo.com/x/topic/crc](http://www.festo.com/x/topic/crc)

Forces [N]								
Piston diameter	20	25	32	40	50	63	80	100
Theoretical force at 6 bar, advancing	188	295	483	754	1178	1870	3016	4712
Theoretical force at 6 bar, retracting	141	247	415	686	1057	1750	2827	4524
Static holding force	250	500			2000		5000	

### Sizing example

**Note**  
 When sizing pneumatic cylinders, it is recommended as a basic principle that only 50% of the indicated theoretical forces (see above) be used

**Assuming:**  
 Mounting position = vertical  
 Workpiece load = 44 kg  
 $F = m \times g = 44 \text{ kg} \times 9.81 \text{ m/s}^2 = 431.6 \text{ N}$

**To be determined:**  
 Suitable piston diameter

**Example with 32 mm piston diameter:**  
 Theoretical force at 6 bar, advancing = 483 N  
 50% of the theoretical force = 241.5 N  
 Static holding force with 32 mm piston diameter = 500 N  
 The static holding force of end-position locking is within the permissible range (max. 500 N) for a workpiece load of 44 kg (431.6 N); however, the cylinder would be at 89% capacity.  
**Results:**  
 A cylinder with a piston diameter of 40 mm is therefore recommended for this application.

Impact energy [J]								
Piston diameter	20	25	32	40	50	63	80	100
Max. impact energy in the end positions	0.2	0.3	0.4	0.7	1	1.3	1.8	2.5

**Note**  
 These specifications represent the maximum values that can be achieved. The maximum permissible impact energy must be observed.

Permissible impact speed:  $V = \sqrt{\frac{2 \times E}{m_1 + m_2}}$

Maximum permissible mass:  $m_2 = \frac{2 \times E}{v^2} - m_1$

V Permissible impact speed  
 E max. impact energy  
 m1 Moving mass (drive)  
 m2 Moving payload

### Max. lateral force Fq as a function of projection x

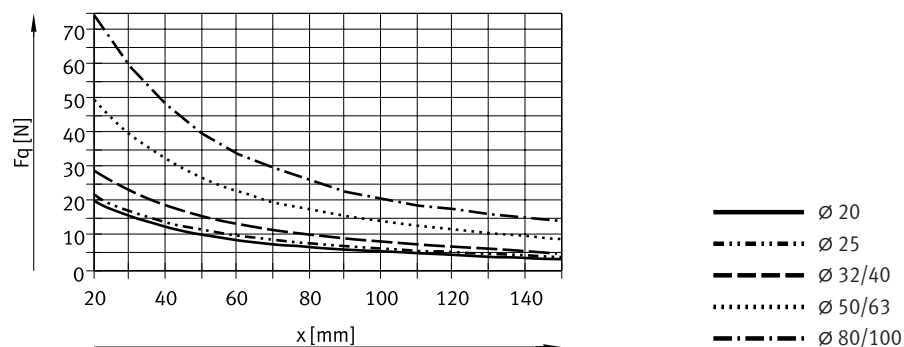

## Datasheet

<b>Weight [g]</b>								
Piston diameter	20	25	32	40	50	63	80	100
<b>End position locking at both ends</b>								
Product weight with 0 mm stroke	234	339	518	665	1334	1734	3300	4735
Additional weight per 10 mm stroke	22	26	29	38	51	59	79	98
Moving mass with 0 mm stroke	43	53	85	101	199	248	475	637
Additional mass per 10 mm stroke	6	6	9	9	16	16	25	25
<b>End-position locking at front</b>								
Product weight with 0 mm stroke	177	248	387	498	922	1228	2296	3448
Additional weight per 10 mm stroke	22	26	29	38	51	59	79	98
Moving mass with 0 mm stroke	35	46	75	98	175	225	464	626
Additional mass per 10 mm stroke	6	6	9	9	16	16	25	25
<b>End-position locking at rear</b>								
Product weight with 0 mm stroke	181	252	380	505	920	1217	2233	3409
Additional weight per 10 mm stroke	22	26	29	38	51	59	79	98
Moving mass with 0 mm stroke	37	45	73	89	168	217	413	582
Additional mass per 10 mm stroke	6	6	9	9	16	16	25	25

**Materials**

## Sectional view

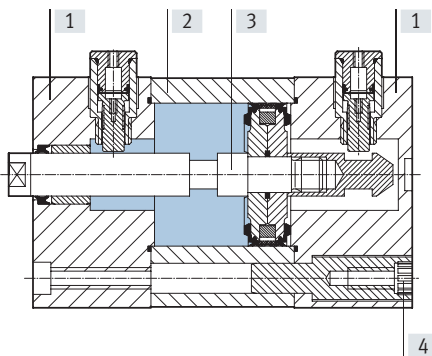

## Compact cylinder

[1]	Cover	Anodised aluminium
[2]	Cylinder barrel	Anodised aluminium
[3]	Piston rod	High-alloy steel
[4]	Flange screws	$\varnothing 20 \dots 63$ $\varnothing 80 \dots 100$ Galvanised steel Standard screws, galvanised steel
-	Seals	Polyurethane, nitrile rubber
	Note on materials	RoHS-compliant

Datasheet

Dimensions – Basic version

Download CAD data → [www.festo.com](http://www.festo.com)

ELB – End-position locking at both ends

∅ 20 ... 63

∅ 32 ... 63

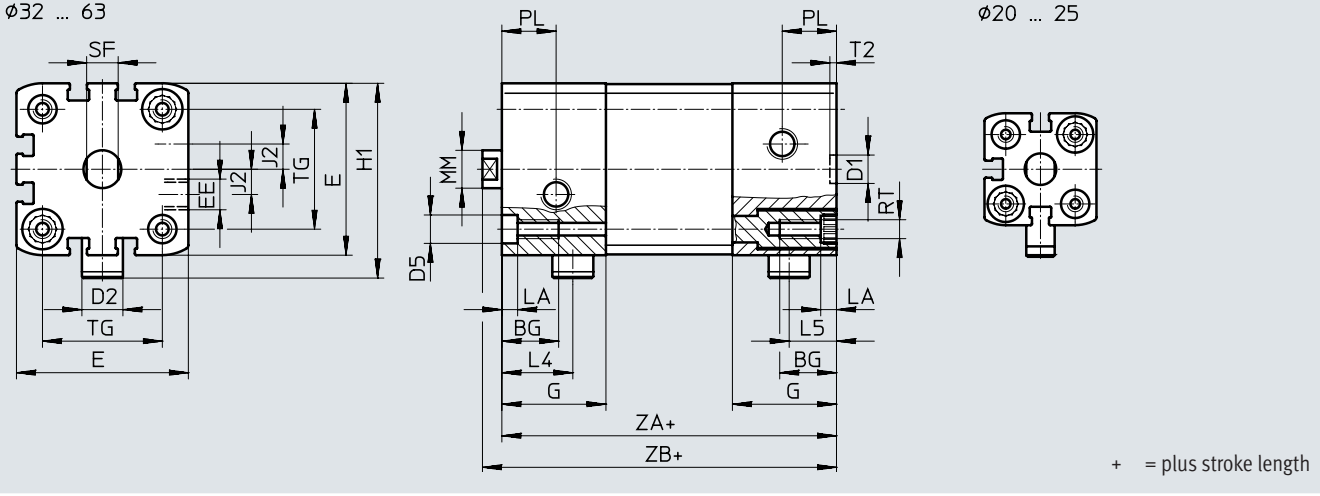

∅ 80 ... 100

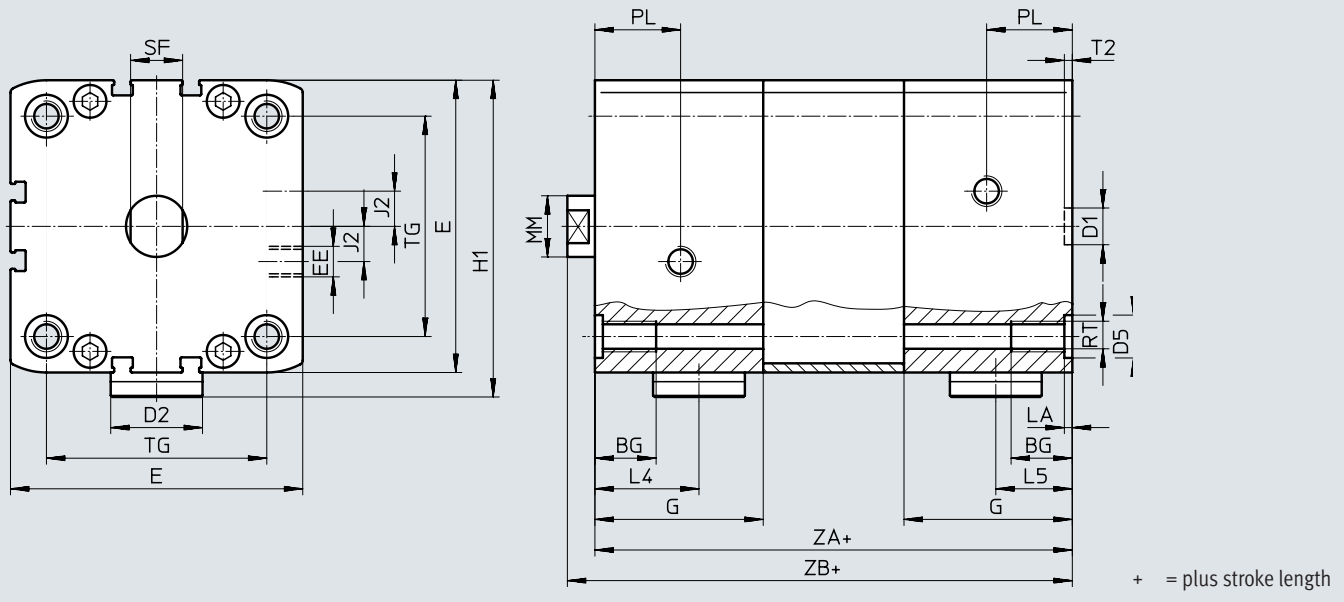

ELV – End-position locking at front

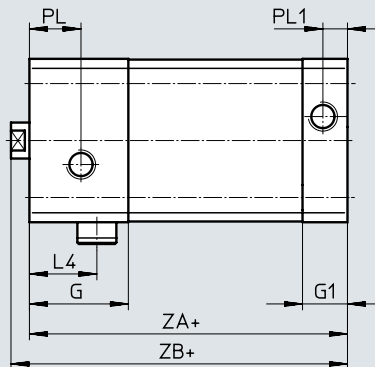

ELH – End-position locking at rear

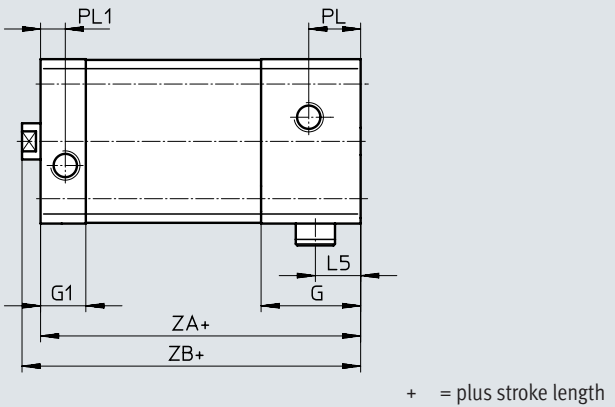



## Datasheet

∅ [mm]	BG min.	D1 ∅ H9	D2 ∅	D5 ∅	E	EE	G	G1	H1	J2	L4	L5
20	18	9	9	9 <sup>F9</sup>	35.5 <sup>+0.3</sup>	M5	25	12	45.5	2.6	18.5	12.5
25			39.5 <sup>+0.3</sup>		29.5		53.3		20.8		14	
32			13		47 <sup>+0.3</sup>	33	15	58	6	22.5	15	
40			54.5 <sup>+0.3</sup>		77		8	20.5				
50	20	12	20	12 <sup>F9</sup>	65.5 <sup>+0.3</sup>	G1/8	43	15	77	11.5	27.5	21.7
63			75.5 <sup>+0.3</sup>	82	25							
80			30	15	95.5 <sup>+0.6</sup>		55		16.5	103.5	34	25
100			113.5 <sup>+0.6</sup>	57	21.5		113.5		20	35	27	

∅ [mm]	PW +0.2	MM ∅	PL	PL1	RT	ST h13	T2 +0.1	TG ±0.2	ZA ±0.6		ZB +1.2	
									ELB	ELV, ELH	ELB	ELV, ELH
20	5	10	6	6	M5	9	2.1	22	63	50	68.8	55.5
25								26	74	56.5	79.5	62
32		12	16	8.2	M6	10		32.5	80	62	86	68
40								38	81	63	87.1	69
50	16	21	M8		13	2.6	46.5	101	73	109.2	81.2	
63							56.5	105	77	113.1	85.1	
80	20	28	M10	17	72		131	92.5	139.9	101.4		
100					10.5		89	138	102.5	147	111.5	

Datasheet

Dimensions – Variants

Download CAD data → [www.festo.com](http://www.festo.com)

Basic version

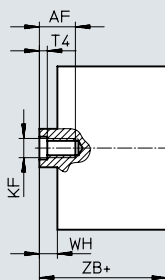
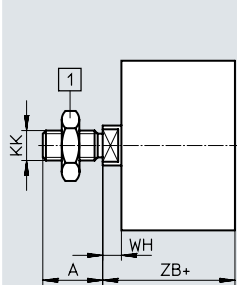

[1] Hex nut DIN 439-B  
only with  $\varnothing 32 \dots 100$

+ = plus stroke length

K2 – Extended male piston rod thread

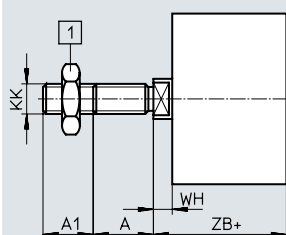

[1] Hex nut DIN 439-B  
only with  $\varnothing 32 \dots 100$

+ = plus stroke length

K5 – Special piston rod thread

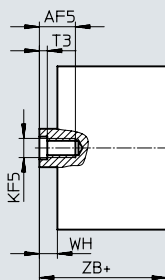
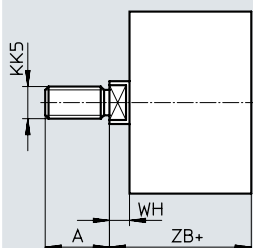

+ = plus stroke length

K8 – Extended piston rod

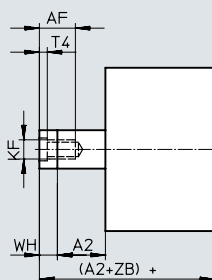
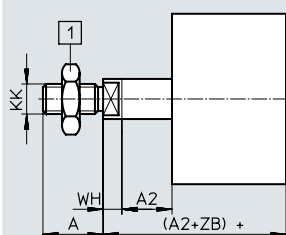

[1] Hex nut DIN 439-B  
only with  $\varnothing 32 \dots 100$

+ = plus stroke length

## Datasheet

∅	A	A1	A2	AF	AF5	KF	KF5
[mm]	-0.5			min.	min.		
20	16	1 ... 20	1 ... 300	14	12	M6	M5
25							
32	19		1 ... 400	16	14	M8	M6
40							
50	22	1 ... 30	1 ... 500	20	16	M10	M8
63							
80	28				20	M12	M10
100							

∅	KK	KK5	T3	T4	WH	ZB +1.2	
[mm]					+1.3	ELB	ELV, ELH
20	M8	M10x1.25 M10	2	2.6	5.5	68.8	55.5
25						79.5	62
32	M10x1.25	M10 M12	2.6	3.3	6	86	68
40						6.1	87.1
50	M12x1.25	M12 M16	3.3	4.7	8.2	109.2	81.2
63						8.1	113.1
80	M16x1.5	M16 M20x1.5 M20	4.7	6.1	8.9	139.9	101.4
100						9	147

## Compact cylinders ADN-EL, standard hole pattern, with end-position locking

### Ordering data – Modular product system

Ordering table													
Size		20	25	32	40	Conditions	Code			Enter code			
Module no.		<b>548214</b>	<b>548215</b>	<b>548216</b>	<b>548217</b>								
Function		Compact cylinder, double-acting, standard hole pattern, with end-position locking					<b>ADN</b>						ADN
Piston diameter	[mm]	20	25	32	40		-...						
Stroke	[mm]	10 ... 300		10 ... 400			-...						
End-position locking		At both ends					<b>-ELB</b>						
		Advanced					<b>-ELV</b>						
		Rear					<b>-ELH</b>						
Piston rod thread		Male thread					<b>-A</b>						
		Female thread				[1]	<b>-I</b>						
Cushioning		Elastic cushioning rings/plates at both ends					<b>-P</b>						-P
Position sensing		Via proximity switch					<b>-A</b>						-A
Extended male thread		Extended male piston rod thread											
	[mm]	1 ... 20					<b>-...K2</b>						
Special piston rod thread	Male thread	M10x1.25 M10	M10x1.25 M10	M10 M12	M10 M12		<b>-“...”K5</b>						
	Female thread	M5	M5	M6	M6								
Extended piston rod		Extended piston rod											
	[mm]	1 ... 300		1 ... 400		[2]	<b>-...K8</b>						
Captive rating plate		Laser-etched rating plate					<b>-TL</b>						

[1] **I** Not with extended male thread K2

[2] **K8** The sum of the stroke length and piston rod extension must not exceed the maximum permissible stroke length

## Ordering data – Modular product system

Ordering table								Enter code
Size	50	63	80	100	Conditions	Code		
Module no.	<b>548218</b>	<b>548219</b>	<b>548220</b>	<b>548221</b>				
Function	Compact cylinder, double-acting, standard hole pattern, with end-position locking					<b>ADN</b>		ADN
Piston diameter [mm]	50	63	80	100		-...		
Stroke [mm]	10 ... 400		10 ... 500			-...		
End-position locking	At both ends					<b>-ELB</b>		
	Advanced					<b>-ELV</b>		
	Rear					<b>-ELH</b>		
Piston rod thread	Male thread					<b>-A</b>		
	Female thread				[1]	<b>-I</b>		
Cushioning	Elastic cushioning rings/plates at both ends					<b>-P</b>		-P
Position sensing	Via proximity switch					<b>-A</b>		-A
Extended male thread [mm]	Extended male piston rod thread							
	1 ... 20		1 ... 30			<b>-...K2</b>		
Special piston rod thread	Male thread	M12 M16	M12 M16	M16 M20 M20x1.5	M16 M20 M20x1.5		<b>-“...”K5</b>	
	Female thread	M8	M8	M10	M10			
Extended piston rod [mm]	Extended piston rod							
	1 ... 400		1 ... 500		[2]	<b>-...K8</b>		
Captive rating plate	Laser-etched rating plate					<b>-TL</b>		

[1] **I** Not with extended male thread K2

[2] **K8** The sum of the stroke length and piston rod extension must not exceed the maximum permissible stroke length

## Type codes

<b>001</b>	<b>Series</b>	
<b>AEN</b>	Compact cylinder, single-acting, based on ISO 21287	

<b>002</b>	<b>Piston diameter [mm]</b>	
<b>12</b>	12	
<b>16</b>	16	
<b>20</b>	20	
<b>25</b>	25	
<b>32</b>	32	
<b>40</b>	40	
<b>50</b>	50	
<b>63</b>	63	
<b>80</b>	80	
<b>100</b>	100	

<b>003</b>	<b>Stroke [mm]</b>	
<b>...</b>	1 ... 25	

<b>004</b>	<b>Piston rod thread type</b>	
<b>A</b>	Male thread	
<b>I</b>	Female thread	

<b>005</b>	<b>Cushioning</b>	
<b>P</b>	Elastic cushioning rings/plates on both sides	

<b>006</b>	<b>Position sensing</b>	
<b>A</b>	For proximity sensor	

<b>007</b>	<b>Active direction</b>	
<b>Z</b>	Single-acting, pulling	
	Single-acting, pushing	

<b>008</b>	<b>Piston rod thread extension</b>	
	None	
<b>...K2</b>	1 ... 30 mm	

<b>009</b>	<b>Custom thread</b>	
<b>"M5"K5</b>	M5	
<b>"M6"K5</b>	M6	
<b>"M8"K5</b>	M8	
<b>"M10"K5</b>	M10	
<b>"M10x1,25"K5</b>	M10x1.25	
<b>"M12"K5</b>	M12	
<b>"M16"K5</b>	M16	
<b>"M20"K5</b>	M20	
<b>"M20x1,5"K5</b>	M20x1.5	

<b>010</b>	<b>Piston rod extension</b>	
	None	
<b>...K8</b>	1 ... 25 mm	

<b>011</b>	<b>Improved running performance</b>	
	None	
<b>K10</b>	Smooth anodised aluminium coated piston rod	

<b>012</b>	<b>Temperature resistance</b>	
	Standard	
<b>S6</b>	Heat-resistant seals max. 120 °C	

<b>013</b>	<b>Captive rating plate</b>	
	Rating plate, glued	
<b>TL</b>	Laser etched rating plate	

## Datasheet

### Function

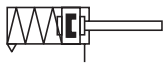

### Pulling

⊘ Diameter  
12 ... 100 mm

— Stroke length  
1 ... 25 mm

 [www.festo.com](http://www.festo.com)

### Variants



S6



K2



K5



K8



K10



Q

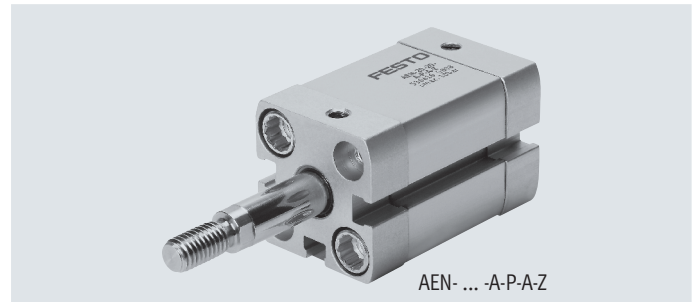
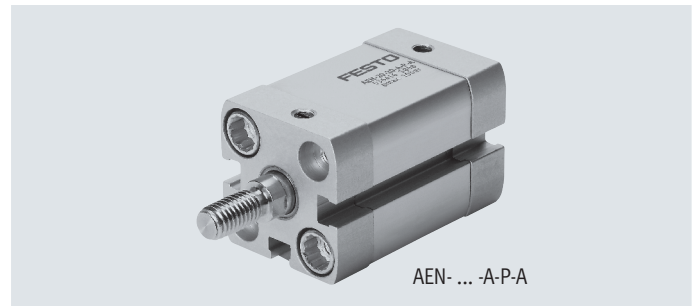

### General technical data

Piston diameter	12	16	20	25	32	40	50	63	80	100
Design	Piston									
	Piston rod									
	Cylinder barrel									
Cushioning	Elastic cushioning rings/plates at both ends									
Position sensing	Via proximity switch									
Type of mounting	Via through-hole									
	With female thread									
	With accessories									
Mounting position	Any									

### Technical data – Basic version and variants

Piston diameter	12	16	20	25	32
Pneumatic connection	M5	M5	M5	M5	G1/8
Female piston rod thread					
—	M3	M4	M6	M6	M8
K5	—	—	M5	M5	M6
Male piston rod thread					
—	M5	M6	M8	M8	M10x1.25
K5	M6	M8	M10; M10x1.25	M10; M10x1.25	M10; M12
Q-K5	—	M8	M10; M10x1.25	M10; M10x1.25	M10

Piston diameter	40	50	63	80	100
Pneumatic connection	G1/8	G1/8	G1/8	G1/8	G1/8
Female piston rod thread					
—	M8	M10	M10	M12	M12
K5	M6	M8	M8	M10	M10
Male piston rod thread					
—	M10x1.25	M12x1.25	M12x1.25	M16x1.5	M16x1.5
K5	M10; M12	M12; M16	M12; M16	M16; M20; M20x1.5	M16; M20; M20x1.5
Q-K5	M10	M12	M12	M16	M16

## Datasheet

Operating and environmental conditions										
Piston diameter	12	16	20	25	32	40	50	63	80	100
Operating medium	Compressed air to ISO 8573-1:2010 [7:4:4]									
Note on the operating/pilot medium	Lubricated operation possible (in which case lubricated operation will always be required)									
Operating pressure										
in [MPa]										
-	0.15 ... 1		0.1 ... 1							
Z	0.17 ... 1	0.22 ... 1	0.13 ... 1		0.07 ... 1	0.06 ... 1				
Q	0.15 ... 1		0.1 ... 1							
Q-S6	0.15 ... 0.6		0.1 ... 0.6							
in [bar]										
-	1.5 ... 10		1 ... 10							
Z	1.7 ... 10	2.2 ... 10	1.3 ... 10		0.7 ... 10	0.6 ... 10				
Q	1.5 ... 10		1 ... 10							
Q-S6	1.5 ... 6		1 ... 6							
in [psi]										
-	21.76 ... 145		14.5 ... 145							
Z	24.66 ... 145	31.91 ... 145	18.85 ... 145		10.15 ... 145	8.7 ... 145				
Q	21.76 ... 145		14.5 ... 145							
Q-S6	21.76 ... 87		14.5 ... 87							
Ambient temperature <sup>1)</sup> [°C]										
-	-20 ... +80									
S6	0 ... +120									
Corrosion resistance class CRC <sup>2)</sup>	2 - Moderate corrosion stress									

1) Note operating range of proximity switches  
 2) More information: [www.festo.com/x/topic/crc](http://www.festo.com/x/topic/crc)

Forces [N] and impact energy [J]										
Piston diameter	12	16	20	25	32	40	50	63	80	100
<b>AEN</b>										
Theoretical force at 6 bar, advancing	56	95	162	259	441	702	1098	1783	2899	4511
<b>AEN-...-Z, pulling</b>										
Theoretical force at 6 bar, retracting	39	65	115	211	373	634	977	1663	2610	4323
Max. impact energy at the end positions	0.04	0.04	0.04	0.08	0.1	0.15	0.18	0.28	0.35	0.7

 **Note**  
 These specifications represent the maximum values that can be achieved. The maximum permissible impact energy must be observed.

Permissible impact speed: 
$$V = \sqrt{\frac{2 \times E}{m_1 + m_2}}$$

Maximum permissible mass: 
$$m_2 = \frac{2 \times E}{v^2} - m_1$$

V Permissible impact speed  
 E max. impact energy  
 m1 Moving mass (drive)  
 m2 Moving payload





## Datasheet

## Spring return force F as a function of stroke l

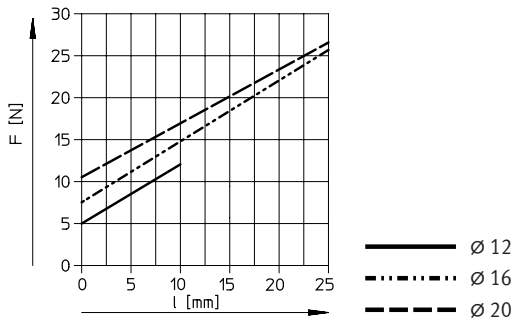
Ø 12 ... 20

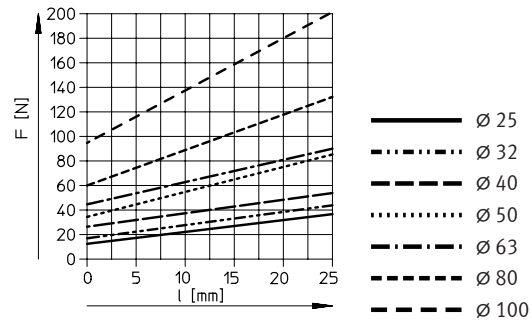

Ø 25 ... 100

 Note

The degree of friction depends on the mounting position and the type of load involved. Single-acting cylinders should as far as possible be operated without transverse loads.

Weight [g]	12	16	20	25	32	40	50	63	80	100
Piston diameter	12	16	20	25	32	40	50	63	80	100
<b>AEN-...</b>										
Product weight with 0 mm stroke	67	78	131	168	273	361	532	752	1135	1733
Additional weight per 10 mm stroke	12	14	22	26	29	38	51	60	80	99
Moving mass with 0 mm stroke	11	18	32	41	76	103	164	220	425	587
Additional mass per 10 mm stroke	2	4	6	6	9	9	16	16	25	25
<b>AEN-...-I</b>										
Product weight with 0 mm stroke	65	75	122	159	248	336	490	710	1050	1648
Additional weight per 10 mm stroke	12	14	22	26	29	38	51	60	80	99
Moving mass with 0 mm stroke	9	15	23	32	51	78	122	178	340	502
Additional mass per 10 mm stroke	2	4	6	6	9	9	16	16	25	25
<b>AEN-...-Q</b>										
Product weight with 0 mm stroke	–	78	130	168	270	362	539	754	1147	1741
Additional weight per 10 mm stroke	–	14	22	26	28	37	47	55	75	94
Moving mass with 0 mm stroke	–	18	32	41	73	97	155	210	415	567
Additional mass per 10 mm stroke	–	4	6	6	8	8	11	11	20	20
<b>AEN-...-K10</b>										
Product weight with 0 mm stroke	–	–	134	170	278	366	551	764	1135	1725
Additional weight per 10 mm stroke	–	–	18	22	23	32	41	47	61	80
Moving mass with 0 mm stroke	–	–	35	43	89	108	184	231	425	579
Additional mass per 10 mm stroke	–	–	2	2	3	3	5	4	6	6
<b>AEN-...-K8</b>										
Additional weight and mass per 10 mm piston rod extension	2	4	6	6	9	9	16	16	25	25
<b>AEN-...-K2</b>										
Additional weight and mass per 10 mm extended piston rod thread	2	2	4	4	6	6	9	9	16	16
<b>AEN-...-Z</b>										
Product weight with 0 mm stroke	64	74	125	166	265	361	532	752	1135	1733
Additional weight per 10 mm stroke	12	14	22	26	29	38	51	60	80	99
Moving mass with 0 mm stroke	11	18	32	41	76	103	164	220	425	587
Additional mass per 10 mm stroke	2	4	6	6	9	9	16	16	25	25

## Datasheet

### Materials

Sectional view

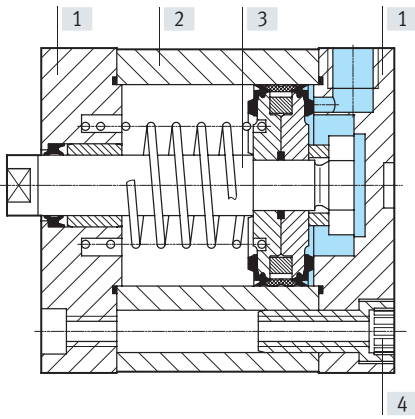

## Datasheet

Compact cylinder		Basic version	S6
[1]	Cover	ø 12 ... 80 ø 100	Anodised aluminium Coated die-cast aluminium
[2]	Cylinder barrel		Anodised aluminium
[3]	Piston rod		High-alloy steel
[4]	Flange screws	ø 12 ... 16	High-alloy steel
		ø 20 ... 63	Galvanised steel
		ø 80 ... 100	Standard screws, galvanised steel
-	Seals		Polyurethane   Fluoro rubber
	Note on materials		RoHS-compliant

Datasheet

Dimensions – Basic version

Download CAD data → [www.festo.com](http://www.festo.com)

∅ 12 ... 63

∅ 32 ... 63

∅ 12 ... 25

∅ 12

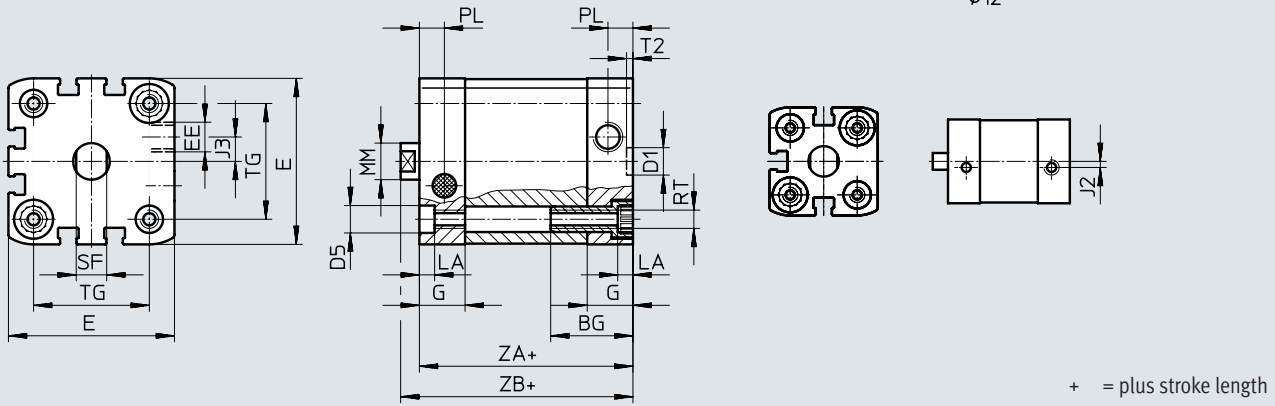

∅ 80 ... 100

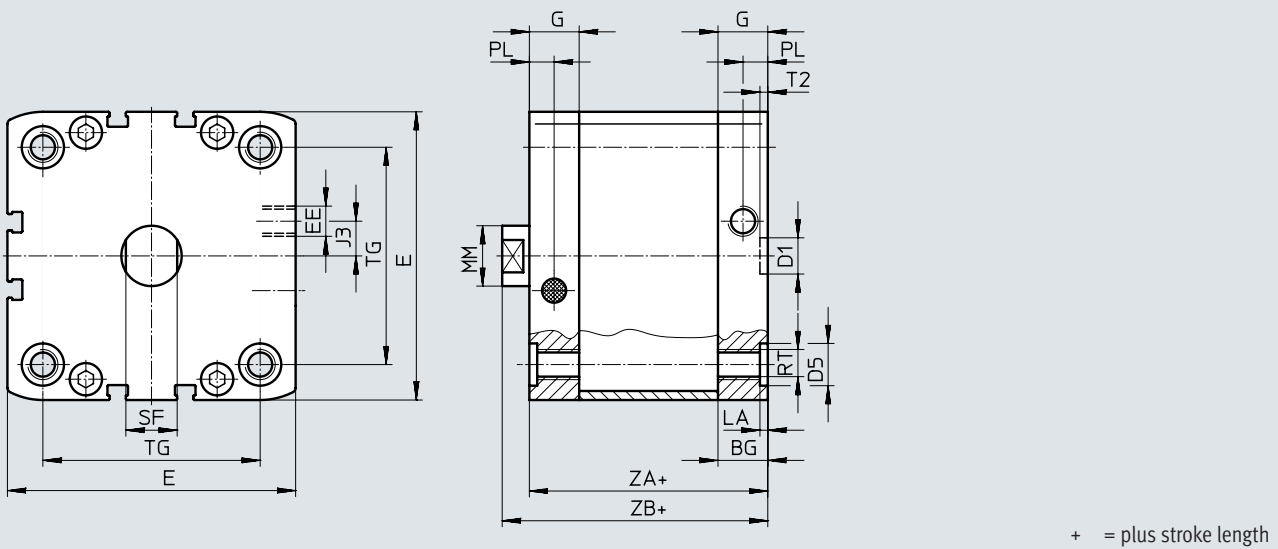

## Datasheet

∅ [mm]	BG min.	D1 ∅ H9	D5 ∅	E	EE	G	J2	J3	PW +0.2
12	17	9	6 <sup>F9</sup>	27.5 <sup>+0.3</sup>	M5	10.5	2	–	3.5
16				29 <sup>+0.3</sup>		11	2.6		
20	19.5		9 <sup>F9</sup>	35.5 <sup>+0.3</sup>		12			
25				39.5 <sup>+0.3</sup>	15	6	5		
32	26		47 <sup>+0.3</sup>	8					
40			54.5 <sup>+0.3</sup>	11.5					
50	27	12	12 <sup>F9</sup>	65.5 <sup>+0.3</sup>	G1/8	16.5	20	2.6	
63			75.5 <sup>+0.3</sup>						
80	17		15	95.5 <sup>+0.6</sup>					21.5
100	21.5	113.5 <sup>+0.6</sup>							

∅ [mm]	MM ∅	PL +0.2	RT	ST h13	T2 +0.1	TG ±0.2	ZA ±0.3	ZB +1.2
12	6	6	M4	5	2.1	16	35	39.2
16	8			7		18		39.7
20	10		M5	9		22	42.5	
25				26		44.5		
32	12	8.2	M6	10		32.5	44	50
40				38	51.1			
50	16		M8	13	46.5	45	53.2	
63		56.5		49	57.1			
80	20	10.5	M10	17	72	54	62.9	
100				89	67	76		

## Datasheet

### Dimensions – Variants

Download CAD data → [www.festo.com](http://www.festo.com)

Basic version

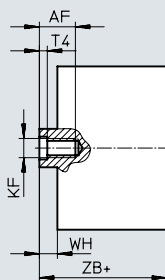
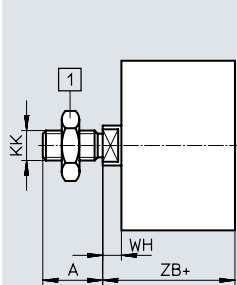

[1] Hex nut DIN 439-B  
only with  $\varnothing 32 \dots 100$

+ = plus stroke length

Z – Pulling

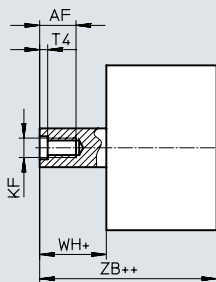
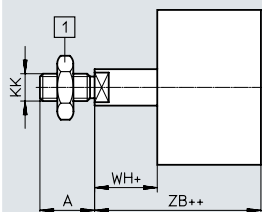

[1] Hex nut DIN 439-B  
only with  $\varnothing 32 \dots 100$

+ = plus stroke length

++ = plus 2x stroke length

K2 – Extended male piston rod thread

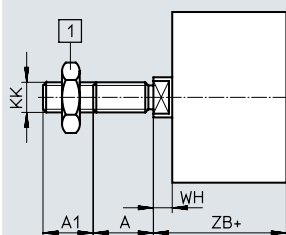

[1] Hex nut DIN 439-B  
only with  $\varnothing 32 \dots 100$

+ = plus stroke length

K5 – Special piston rod thread

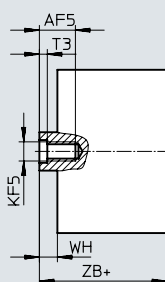
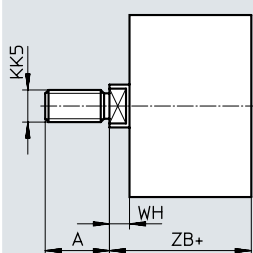

+ = plus stroke length

K8 – Extended piston rod

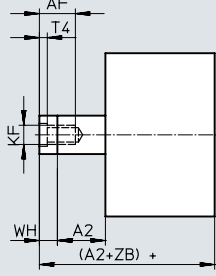
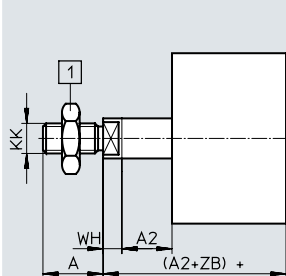

[1] Hex nut DIN 439-B  
only with  $\varnothing 32 \dots 100$

+ = plus stroke length

## Datasheet

∅ [mm]	A -0.5	A1	A2	AF min.	AF5 min.	KF	KF5
12	10	1 ... 10	1 ... 300	8	-	M3	-
16	12			10		M4	
20	16	1 ... 20		14	12	M6	M5
25			16	14	M8	M6	
32	19		1 ... 400	16	14	M8	M6
40	19			16	14	M8	M6
50	22	1 ... 30	1 ... 500	20	16	M10	M8
63					16	M10	M8
80	28	1 ... 30	1 ... 500	20	20	M12	M10
100							

∅ [mm]	KK	KK5	T3	T4	WH +1.3	ZB +1.2
12	M5	M6	-	1.5	4.2	39.2
16	M6	M8			4.7	39.7
20	M8	M10x1.25 M10	2	2.6	5.5	42.5
25					5.5	44.5
32	M10x1.25	M10 M12	2.6	3.3	6	50
40					6.1	51.1
50	M12x1.25	M12 M16	3.3	4.7	8.2	53.2
63					8.1	57.1
80	M16x1.5	M16 M20x1.5 M20	4.7	6.1	8.9	62.9
100					9	76

## Datasheet

### Dimensions – Variants

Download CAD data → [www.festo.com](http://www.festo.com)

#### Q – Square piston rod

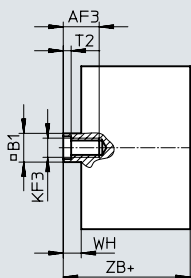
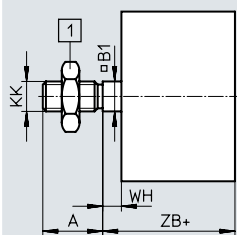

[1] Hex nut DIN 439-B  
only with  $\varnothing 32 \dots 100$

+ = plus stroke length  
++ = plus 2x stroke length

#### Q – Z – Pulling

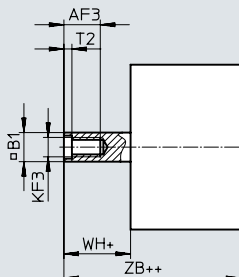
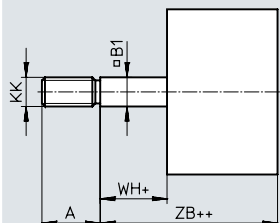

+ = plus stroke length

#### Q-K2 – Square piston rod with extended male thread

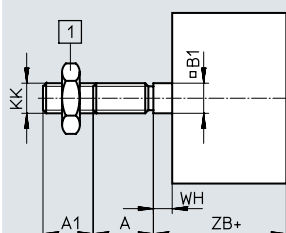

[1] Hex nut DIN 439-B  
only with  $\varnothing 32 \dots 100$

+ = plus stroke length

#### Q-K5 – Square piston rod with special piston rod thread

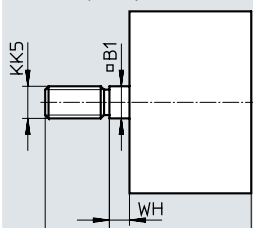

+ = plus stroke length

#### Q-K8 – Square, extended piston rod

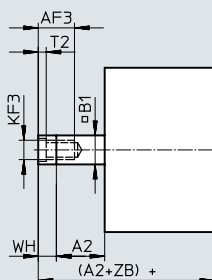
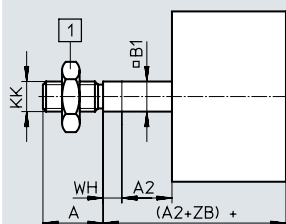

[1] Hex nut DIN 439-B  
only with  $\varnothing 32 \dots 100$

+ = plus stroke length



## Datasheet

∅ [mm]	A -0.5	A1	A2	AF3 min.	B1 □	KF3
16	12	1 ... 10	1 ... 300	10	7	M4
20 25	16	1 ... 20		12	9	M5
32 40	19		14	10	M6	
50 63	22		16	12	M8	
80 100	28		1 ... 30	1 ... 500	20	16

∅ [mm]	KK	KK5	T2	WH +1.3	ZB +1.2
16	M6	M8	1.5	4.7	39.7
20 25	M8	M10x1.25 M10	2	5.5	42.5
32					44.5
40	M10x1.25	M10	2.6	6	50
50	M12x1.25	M12	3.3	6.1	51.1
63				8.2	53.2
80				8.1	57.1
100	M16x1.5	M16	4.7	8.9	62.9
				9	76

Ordering data – Modular product system, basic version and variants

Ordering table								Conditions	Code	Enter code
Size	12	16	20	25	32					
Module no.	<b>536414</b>	<b>536415</b>	<b>536416</b>	<b>536417</b>	<b>536418</b>					
Function	Compact cylinder, single-acting							<b>AEN</b>	AEN	
Standard	Based on ISO 21287		Conforms to ISO 21287							
Piston diameter [mm]	12	16	20	25	32			-...		
Stroke [mm]	1 ... 10		1 ... 25					-...		
Thread type	Male thread							<b>-A</b>		
	Female thread					[1]		<b>-I</b>		
Cushioning	Elastic cushioning rings/plates at both ends							<b>-P</b>	-P	
Position sensing	Via proximity switch							<b>-A</b>	-A	
Effective direction	Single-acting, pulling							<b>-Z</b>		
Extended male thread [mm]	Extended male piston rod thread		1 ... 20			[2]		<b>-...K2</b>		
	1 ... 10									
Special piston rod thread	Male thread	M6	M8	M10x1.25 M10	M10x1.25 M10	M10 M12	[2]	<b>-“...”K5</b>		
	Female thread	-	-	M5	M5	M6				
Extended piston rod [mm]	Extended piston rod		1 ... 25					<b>-...K8</b>		
Improved running performance	-		Smooth anodised aluminium piston rod					<b>-K10</b>		
Temperature resistance	Heat-resistant seals max. 120 °C							<b>-S6</b>		
Captive rating plate	Laser-etched rating plate							<b>-TL</b>		

[1] I Not with extended male thread K2

[2] K2, K5 Not with improved running performance K10

## Ordering data – Modular product system, basic version and variants

Ordering table									
Size	40	50	63	80	100	Conditions	Code	Enter code	
Module no.	<b>536419</b>	<b>536420</b>	<b>536421</b>	<b>536422</b>	<b>536423</b>				
Function	Compact cylinder, single-acting						<b>AEN</b>	AEN	
Standard	Conforms to ISO 21287								
Piston diameter [mm]	40	50	63	80	100		-...		
Stroke [mm]	1 ... 25								
Thread type	Male thread						<b>-A</b>		
	Female thread					[1]	<b>-I</b>		
Cushioning	Elastic cushioning rings/plates at both ends						<b>-P</b>	-P	
Position sensing	Via proximity switch						<b>-A</b>	-A	
Effective direction	Single-acting, pulling						<b>-Z</b>		
Extended male thread [mm]	Extended male piston rod thread								
	1 ... 20			1 ... 30		[2]	<b>-...K2</b>		
Special piston rod thread	Male thread	M10 M12	M12 M16	M12 M16	M16 M20 M20x1.5	M16 M20 M20x1.5	[2]	<b>-“...”K5</b>	
	Female thread	M6	M8	M8	M10	M10			
Extended piston rod [mm]	Extended piston rod								
	1 ... 25						<b>-...K8</b>		
Improved running performance	Smooth anodised aluminium piston rod						<b>-K10</b>		
Temperature resistance	Heat-resistant seals max. 120 °C						<b>-S6</b>		
Captive rating plate	Laser-etched rating plate						<b>-TL</b>		

[1] I Not with extended male thread K2

[2] K2, K5 Not with improved running performance K10

## Ordering data – Modular product system, Q – Square piston rod, non-rotating

Ordering table								Enter code
Size	16	20	25	32	Conditions	Code		Enter code
Module no.	<b>536415</b>	<b>536416</b>	<b>536417</b>	<b>536418</b>				
Function	Compact cylinder, single-acting					<b>AEN</b>		AEN
Standard	Based on ISO 21287		Conforms to ISO 21287					
Piston diameter [mm]	16	20	25	32		-...		
Stroke [mm]	1 ... 25					-...		
Thread type	Male thread					<b>-A</b>		
	Female thread				[1]	<b>-I</b>		
Cushioning	Elastic cushioning rings/plates at both ends					<b>-P</b>		-P
Position sensing	Via proximity switch					<b>-A</b>		-A
Effective direction	Single-acting, pulling					<b>-Z</b>		
Protection against rotation	Square piston rod					<b>-Q</b>		-Q
Extended male thread [mm]	Extended male piston rod thread							
	1 ... 10	1 ... 20				<b>-...K2</b>		
Special piston rod thread	Male thread	M8	M10x1.25	M10x1.25	M10		<b>-“...”K5</b>	
			M10	M10				
Extended piston rod [mm]	Extended piston rod							
	1 ... 25					<b>-...K8</b>		
Temperature resistance	Heat-resistant seals max. 120 °C					<b>-S6</b>		
Captive rating plate	Laser-etched rating plate					<b>-TL</b>		

[1] I Not with extended male thread K2

## Ordering data – Modular product system, Q – Square piston rod, non-rotating

Ordering table								
Size	40	50	63	80	100	Conditions	Code	Enter code
Module no.	<b>536419</b>	<b>536420</b>	<b>536421</b>	<b>536422</b>	<b>536423</b>			
Function	Compact cylinder, single-acting						<b>AEN</b>	AEN
Standard	Conforms to ISO 21287							
Piston diameter [mm]	40	50	63	80	100		-...	
Stroke [mm]	1 ... 25						-...	
Thread type	Male thread						<b>-A</b>	
	Female thread					[1]	<b>-I</b>	
Cushioning	Elastic cushioning rings/plates at both ends						<b>-P</b>	-P
Position sensing	Via proximity switch						<b>-A</b>	-A
Effective direction	Single-acting, pulling						<b>-Z</b>	
Protection against rotation	Square piston rod						<b>-Q</b>	-Q
Extended male thread [mm]	Extended male piston rod thread							
	1 ... 20			1 ... 30			<b>-...K2</b>	
Special piston rod thread	Male thread	M10	M12	M12	M16	M16	<b>-“...”K5</b>	
Extended piston rod [mm]	Extended piston rod							
	1 ... 25						<b>-...K8</b>	
Temperature resistance	Heat-resistant seals max. 120 °C						<b>-S6</b>	
Captive rating plate	Laser-etched rating plate						<b>-TL</b>	

[1] I Not with extended male thread K2

## Accessories

### Foot mounting HNA/HNA-...-R3

Material:  
 HNA: Galvanised steel  
 HNA-...-R3: steel,  
 with protective coating  
 RoHS-compliant

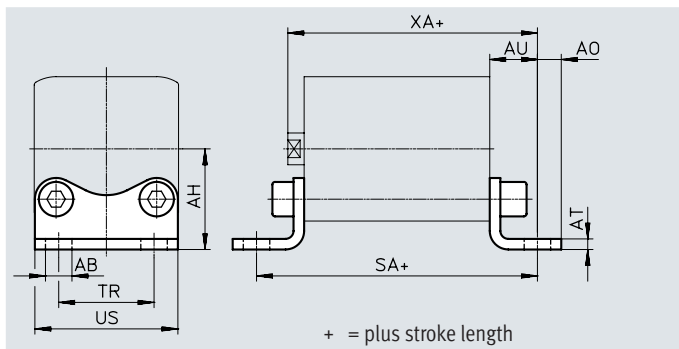

#### Dimensions and ordering data

For $\varnothing$ [mm]	AB $\varnothing$ H14	AH JS14	AO	AT $\pm 0.5$	AU $\pm 0.2$	SA	TR $\pm 0.2$	US $-0.5$	XA
12	5.8	21	5	3	13	61	16	26	52.2
16		22	4.75					27.5	
20	7	27	6.25	4	16	69	22	34.5	58.7
25		29						38.5	
32		33.5						7	
40	10	38	9	5	18	81	36	54	69.2
50		45	8					64	
63		50						75	
80	12	63	10.5	6	26	106	63	93	89
100	14.5	74	12.5					27	

For $\varnothing$ [mm]	Basic version				R3 – High corrosion protection			
	CRC <sup>1)</sup>	Weight [g]	Part no.	Type	CRC <sup>1)</sup>	Weight [g]	Part no.	Type
12	1 - low	39	537237	HNA-12	3	39	537252	HNA-12-R3
16	1 - low	42	537238	HNA-16	3	42	537253	HNA-16-R3
20	1 - low	84	537239	HNA-20	3	84	537254	HNA-20-R3
25	1 - low	90	537240	HNA-25	3	90	537255	HNA-25-R3
32	1 - low	123	537241	HNA-32	3	123	537256	HNA-32-R3
40	1 - low	157	537242	HNA-40	3	157	537257	HNA-40-R3
50	1 - low	278	537243	HNA-50	3	278	537258	HNA-50-R3
63	1 - low	328	537244	HNA-63	3	328	537259	HNA-63-R3
80	1 - low	634	537249	HNA-80	3	634	537260	HNA-80-R3
100	1 - low	814	537250	HNA-100	3	814	537261	HNA-100-R3

1) More information: [www.festo.com/x/topic/crc](http://www.festo.com/x/topic/crc)

## Accessories

### Flange mounting FNC

Material:  
Galvanised steel  
RoHS-compliant

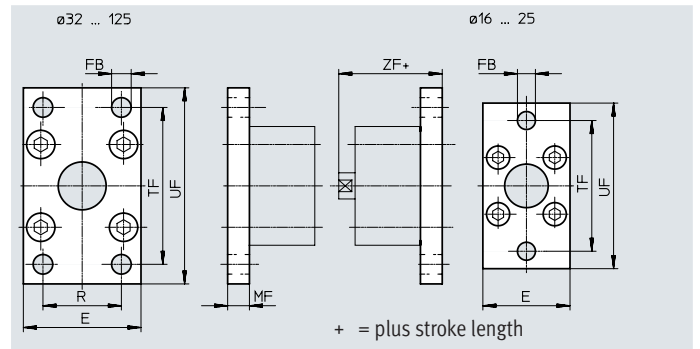

#### Dimensions and ordering data

For $\varnothing$ [mm]	E	FB $\varnothing$	MF	R	TF	UF $\pm 1$	ZF	CRC <sup>1)</sup>	Weight [g]	Part no.	Type
12	28	5.5	8	-	40	50	47.2	1 - low	79	537245	FNC-12
16	29				43	55	47.9	1 - low	88	537246	FNC-16
20	36	6.6			55	70	50.7	1 - low	141	537247	FNC-20
25	40				60	76	52.7	1 - low	165	537248	FNC-25
32	45	7	10	32	64	80	60.2	1 - low	221	★ 174376	FNC-32
40	54	9		36	72	90	61.2	1 - low	291	★ 174377	FNC-40
50	65	9	12	45	90	110	65.2	1 - low	536	★ 174378	FNC-50
63	75			50	100	120	69.2	1 - low	679	★ 174379	FNC-63
80	93	12	16	63	126	150	79	1 - low	1495	★ 174380	FNC-80
100	110	14		75	150	175	92	1 - low	2041	174381	FNC-100
125	132	16	20	90	180	210	112	1 - low	3775	174382	FNC-125

1) More information: [www.festo.com/x/topic/crc](http://www.festo.com/x/topic/crc)

## Accessories

### Swivel flange SNCL/SNCL-...-R3

Material:  
 SNCL 12 ... 25:  
 Wrought aluminium alloy  
 SNCL 32 ... 125:  
 Die-cast aluminium  
 SNCL-...-R3: Wrought aluminium alloy  
 with protective coating  
 RoHS-compliant

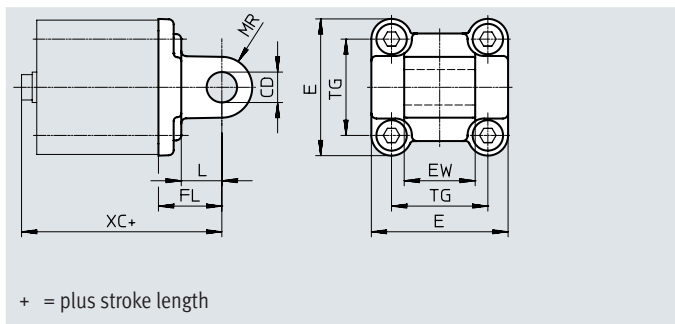

#### Dimensions and ordering data

For $\varnothing$ [mm]	CD $\varnothing$ H10	E	EW	FL $\pm 0.2$	L	MR	TG	XC
12	6	25 <sub>-0.6</sub>	12 <sub>h12</sub>	16	10	6	16	55.2
16		27.5 <sub>-0.6</sub>					18	
20	8	34.5 <sub>-0.6</sub>	16 <sub>h12</sub>	20	14	8	22	62.7
25		38.5 <sub>-0.6</sub>					26	
32	10	45 <sub>+0.2/-0.5</sub>	26 <sub>-0.2/-0.6</sub>	22	13	10	32.5	72.2
40	12	54 <sub>-0.5</sub>	28 <sub>-0.2/-0.6</sub>	25	16	12	38	75.2
50		64 <sub>-0.6</sub>	32 <sub>-0.2/-0.6</sub>	27			46.5	
63	16	75 <sub>-0.6</sub>	40 <sub>-0.2/-0.6</sub>	32	21	16	56.5	89.2
80		93 <sub>-0.8</sub>	50 <sub>-0.2/-0.6</sub>	36			72	
100	20	110 <sub>+0.3/-0.8</sub>	60 <sub>-0.2/-0.6</sub>	41	27	20	89	117
125	25	131 <sub>-0.8</sub>	70 <sub>-0.2/-0.6</sub>	50	30	25	110	142

For $\varnothing$ [mm]	Basic version				R3 – High corrosion protection			
	CRC <sup>1)</sup>	Weight [g]	Part no.	Type	CRC <sup>1)</sup>	Weight [g]	Part no.	Type
12	2 - moderate	20	537790	SNCL-12	3	20	537794	SNCL-12-R3
16	2 - moderate	21	537791	SNCL-16	3	21	537795	SNCL-16-R3
20	2 - moderate	38	537792	SNCL-20	3	38	537796	SNCL-20-R3
25	2 - moderate	41	537793	SNCL-25	3	41	537797	SNCL-25-R3
32	1 - low	71	★ 174404	SNCL-32	–	–	–	–
40	1 - low	95	★ 174405	SNCL-40	–	–	–	–
50	1 - low	158	★ 174406	SNCL-50	–	–	–	–
63	1 - low	225	★ 174407	SNCL-63	–	–	–	–
80	1 - low	436	★ 174408	SNCL-80	–	–	–	–
100	1 - low	606	174409	SNCL-100	–	–	–	–
125	1 - low	1135	174410	SNCL-125	–	–	–	–

1) More information: [www.festo.com/x/topic/crc](http://www.festo.com/x/topic/crc)



## Accessories

### Swivel flange

SNCS/CRSNCS/SNCS-...-R3

Material:

SNCS 32 ... 50: Die-cast aluminium

SNCS 63 ... 125: Wrought aluminium alloy

CRSNCS 32 ... 80:

High-alloy stainless steel

SNCS-...-R3 100 ... 125:

Wrought aluminium alloy with protective coating

RoHS-compliant

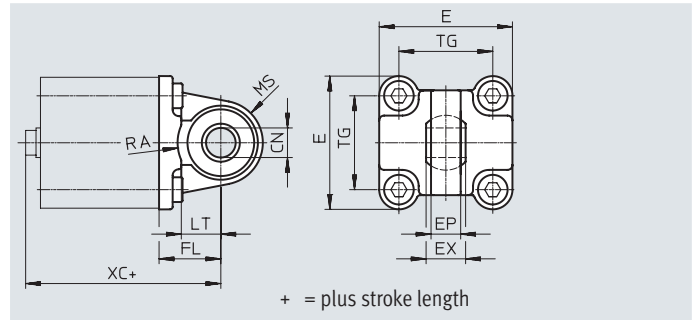
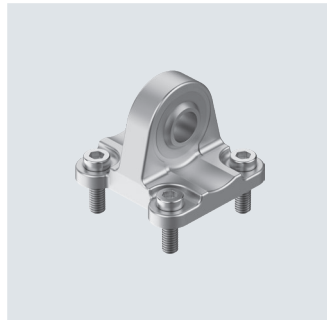

+ = plus stroke length

### Dimensions and ordering data

For $\varnothing$ [mm]	CN $\varnothing$		E		EP $\pm 0.2$	EX	FL $\pm 0.2$
	ADN-...	ADN-...-R3	ADN-...	ADN-...-R3			
32	10 <sup>+0.013</sup>	10+0.015/-0.04	45+0.2/-0.5	45 <sub>-0.5</sub>	10.5	14	22
40	12 <sup>+0.015</sup>	12+0.018/-0.04	54 <sub>-0.5</sub>	54 <sub>-0.5</sub>	12	16	25
50	16 <sup>+0.015</sup>	16+0.018/-0.04	64 <sub>-0.6</sub>	64 <sub>-0.6</sub>	15	21	27
63	16 <sup>+0.015</sup>	16+0.018/-0.04	74.5 $\pm 0.5$	75 <sub>-0.6</sub>	15	21	32
80	20 <sup>+0.018</sup>	20+0.021/-0.04	92.2 $\pm 0.8$	93 <sub>-0.8</sub>	18	25	36
100	20 <sup>+0.018</sup>	20+0.021/-0.04	109+1/-0.7	109+1/-0.7	18	25	41
125	30 <sup>+0.018</sup>	30+0.021/-0.04	132+1/-0.7	132+1/-0.7	25	37	50

For $\varnothing$ [mm]	LT	MS		RA		TG	XC
		ADN-...	ADN-...-R3	ADN-... +1	ADN-...-R3 +1		
32	13	15 <sup>+0.5</sup>	15 <sup>+0.5</sup>	14.5	14.5	32.5	72.2
40	16	17 <sup>+0.5</sup>	17 <sup>+0.5</sup>	17.5	17.5	38	75.2
50	16	20 <sup>+0.5</sup>	20 <sup>+0.5</sup>	18.5	19	46.5	80.2
63	21	23 <sub>-0.5</sub>	22 <sup>+0.5</sup>	23	23	56.5	89.2
80	22	28 <sub>-0.5</sub>	27 <sup>+0.5</sup>	25	25	72	99
100	27	30 $\pm 0.5$	30 $\pm 0.5$	95	100	89	117
125	30	39 $\pm 0.5$	39 $\pm 0.5$	100	100	110	142

For $\varnothing$ [mm]	Basic version				High corrosion protection			
	CRC <sup>1)</sup>	Weight [g]	Part no.	Type	CRC <sup>1)</sup>	Weight [g]	Part no.	Type
32	1 - low	86	★ 174397	SNCS-32	4	161	2895920	CRSNCS-32
40	1 - low	122	★ 174398	SNCS-40	4	239	2895921	CRSNCS-40
50	1 - low	216	★ 174399	SNCS-50	4	403	2895922	CRSNCS-50
63	2 - moderate	281	★ 174400	SNCS-63	4	576	2895923	CRSNCS-63
80	2 - moderate	557	★ 174401	SNCS-80	4	1173	2895924	CRSNCS-80
100	2 - moderate	683	174402	SNCS-100	3	684	2895925	SNCS-100-R3
125	2 - moderate	1369	174403	SNCS-125	3	1369	2895926	SNCS-125-R3

1) More information: [www.festo.com/x/topic/crc](http://www.festo.com/x/topic/crc)

## Accessories

### Clevis foot LBG/LBG-...-R3

The pivot pin is secured against rotation with a spring pin.

Material:

LBG 32 ... 63: Stainless steel casting

LBG 80 ... 125: Spheroidal graphite cast iron

LBG-...-R3: High-alloy stainless steel

RoHS-compliant

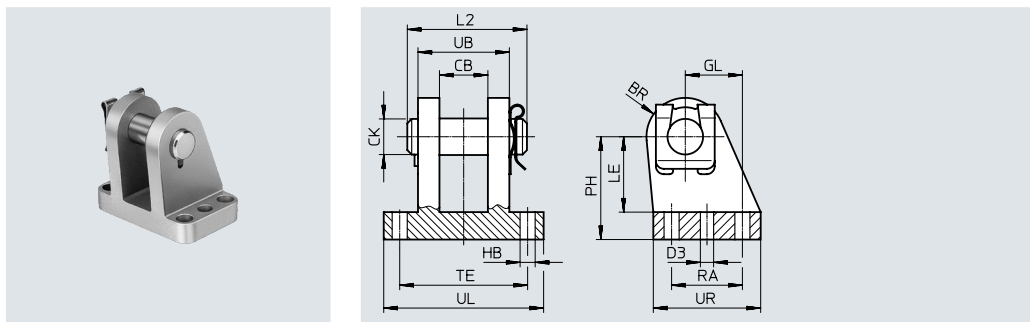

#### Dimensions and ordering data

For $\varnothing$ [mm]	BR		CB	CK $\varnothing$	D3 $\varnothing$	GL	HB $\varnothing$	L2	LE	PH	RA	TE	UB	UL	UR
		ADN-...-R3													
32	12	12	14.1	10	4.8	16	6.8	35	24	32	20	42	28	56	36
40	14	14	16.1	12	5.8	20	6.8	39	26	36	26	44	30	58	41.5
50	15	15	21.1	16	5.8	25	9.2	50	33	45	31	56	40	70	47
63	17	17	21.1	16	7.8	25	9.2	50	38	50	31	56	40	70	49
80	17	17	25.1	20	7.8	30	11	60	49	63	36	70	50	89	55
100	20	22	25.1	20	9.8	41	11	60	56	71	46	70	50	89	65
125	25	25	37.2	30	11.8	60	14	89	70	90	70	106	80	128	96

For $\varnothing$ [mm]	Basic version				R3 – High corrosion protection			
	CRC <sup>1)</sup>	Weight [g]	Part no.	Type	CRC <sup>1)</sup>	Weight [g]	Part no.	Type
32	2 - moderate	220	<b>31761</b>	<b>LBG-32</b>	3	220	<b>2078790</b>	<b>LBG-32-R3</b>
40	2 - moderate	300	<b>31762</b>	<b>LBG-40</b>	3	300	<b>2078792</b>	<b>LBG-40-R3</b>
50	2 - moderate	540	<b>31763</b>	<b>LBG-50</b>	3	540	<b>2078794</b>	<b>LBG-50-R3</b>
63	2 - moderate	580	<b>31764</b>	<b>LBG-63</b>	3	580	<b>2078795</b>	<b>LBG-63-R3</b>
80	2 - moderate	1050	<b>31765</b>	<b>LBG-80</b>	3	1050	<b>2078797</b>	<b>LBG-80-R3</b>
100	2 - moderate	1375	<b>31766</b>	<b>LBG-100</b>	3	1375	<b>2078799</b>	<b>LBG-100-R3</b>
125	2 - moderate	4140	<b>31767</b>	<b>LBG-125</b>	3	4140	<b>2078837</b>	<b>LBG-125-R3</b>

1) More information: [www.festo.com/x/topic/crc](http://www.festo.com/x/topic/crc)

## Accessories

### Multi-position kit DPNA

Material:  
Flange:  
Wrought aluminium alloy  
Screws: Galvanised steel  
RoHS-compliant

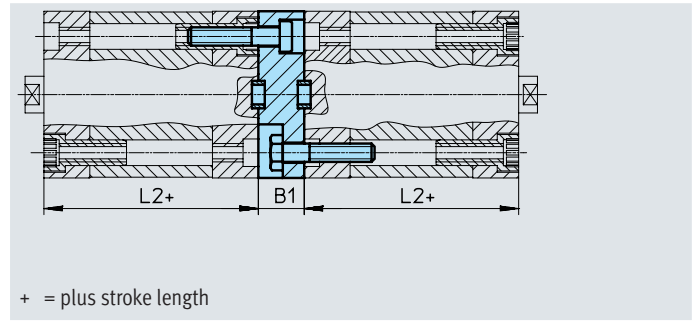
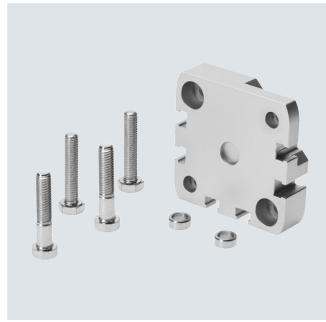

#### Dimensions and ordering data

For $\varnothing$ [mm]	L2	B1	Max. overall stroke length [mm]	CRC <sup>1)</sup>	Weight [g]	Part no.	Type <sup>1)</sup>
12	35	13	600	2 - moderate	28	537263	DPNA-12
16					33	537264	DPNA-16
20					50	537265	DPNA-20
25					60	537266	DPNA-25
32	45	15	800		99	537267	DPNA-32
40					129	537268	DPNA-40
50					16	537269	DPNA-50
63					249	537270	DPNA-63
80	67	17	1000		474	537271	DPNA-80
100		19.5			712	537272	DPNA-100

-  - **Note**

The maximum total stroke length must not be exceeded when combining cylinders and multi-position kits.

1) More information: [www.festo.com/x/topic/crc](http://www.festo.com/x/topic/crc)

## Accessories

### Clevis foot LBN

Material:  
Galvanised steel  
RoHS-compliant

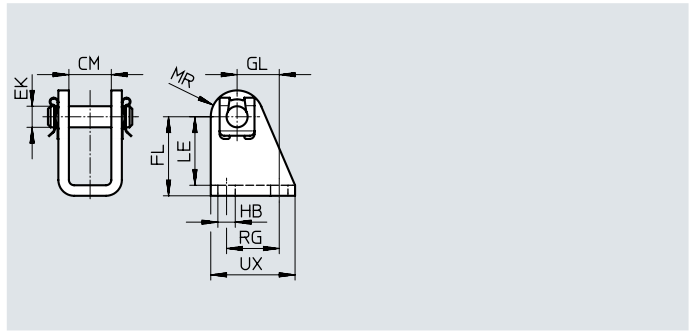

#### Dimensions and ordering data

For $\varnothing$	CM	EK $\varnothing$	FL	GL	HB $\varnothing$	LE	MR	RG	UX	CRC <sup>1)</sup>	Weight [g]	Part no.	Type
[mm]													
12/16	12.1	6	27 +0.3/-0.2	13	5.5	24	7	15	25	1 - low	40	★ 6058	LBN-12/16
20/25	16.1	8	30 +0.4/-0.2	16	6.6	26	10	20	32	1 - low	84	★ 6059	LBN-20/25

1) More information: [www.festo.com/x/topic/crc](http://www.festo.com/x/topic/crc)

### Clevis foot CRLBN, stainless steel

Material:  
High-alloy steel  
RoHS-compliant

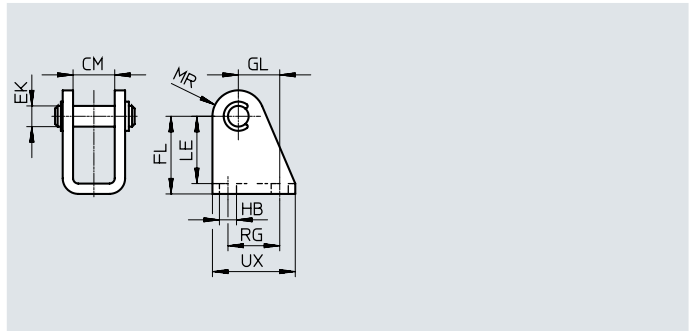
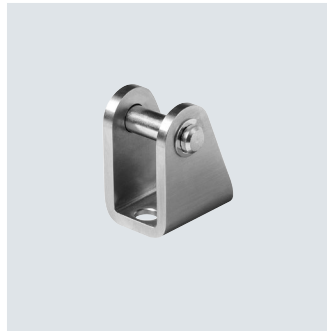

#### Dimensions and ordering data

For $\varnothing$	CM	EK $\varnothing$	FL	GL	HB $\varnothing$	LE	MR	RG	UX	CRC <sup>1)</sup>	Weight [g]	Part no.	Type
[mm]													
12/16	12.1	6	27 +0.3/-0.2	13	5.5	24	7	15	25	4 - very high	39	161862	CRLBN-12/16
20/25	16.1	8	30 +0.4/-0.2	16	6.6	26	10	20	32	4 - very high	82	161863	CRLBN-20/25

1) More information: [www.festo.com/x/topic/crc](http://www.festo.com/x/topic/crc)

## Accessories

### Swivel flange SNCB/SNCB-...-R3

Material:

SNCB: Die-cast aluminium

SNCB-...-R3: Die-cast aluminium with

protective coating

RoHS-compliant

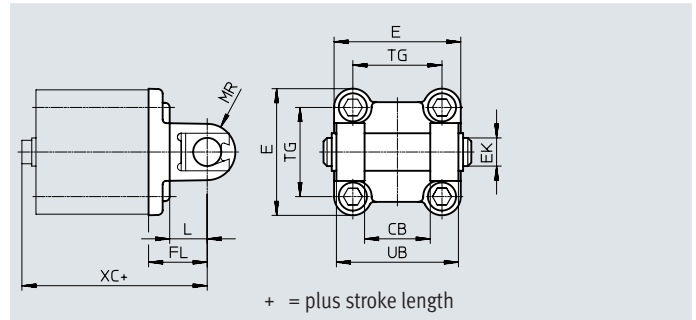
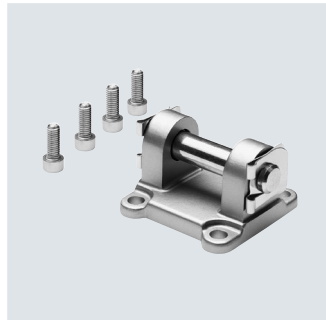

#### Dimensions and ordering data

For $\varnothing$	CB	E	EK $\varnothing$	FL	L	MR	TG	UB	XC
[mm]	H14		H9/e8	$\pm 0.2$		-0.5		h14	
32	26	45 $+0.2/-0.5$	10	22	13	8.5	32.5	45	72
40	28	54 $-0.5$	12	25	16	12	38	52	76
50	32	64 $-0.6$	12	27	16	12	46.5	60	80
63	40	75 $-0.6$	16	32	21	16	56.5	70	89
80	50	93 $-0.8$	16	36	22	16	72	90	99
100	60	110 $+0.3/-0.8$	20	41	27	20	89	110	117
125	70	131 $-0.8$	25	50	30	25	110	130	142

For $\varnothing$	Basic version				R3 – High corrosion protection			
	CRC <sup>1)</sup>	Weight [g]	Part no.	Type	CRC <sup>1)</sup>	Weight [g]	Part no.	Type
32	1 - low	103	★ 174390	SNCB-32	3	100	176944	SNCB-32-R3
40	1 - low	155	★ 174391	SNCB-40	3	151	176945	SNCB-40-R3
50	1 - low	233	★ 174392	SNCB-50	3	228	176946	SNCB-50-R3
63	1 - low	375	★ 174393	SNCB-63	3	371	176947	SNCB-63-R3
80	1 - low	636	★ 174394	SNCB-80	3	632	176948	SNCB-80-R3
100	1 - low	1035	174395	SNCB-100	3	986	176949	SNCB-100-R3
125	1 - low	1860	174396	SNCB-125	3	1776	176950	SNCB-125-R3

1) More information: [www.festo.com/x/topic/crc](http://www.festo.com/x/topic/crc)

## Accessories

### Trunnion flange ZNCF/CRZNG

Material:  
 ZNCF: Stainless steel casting  
 CRZNG: Electropolished stainless steel casting  
 RoHS-compliant

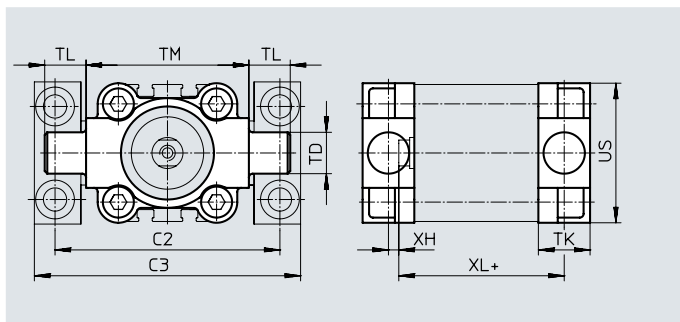
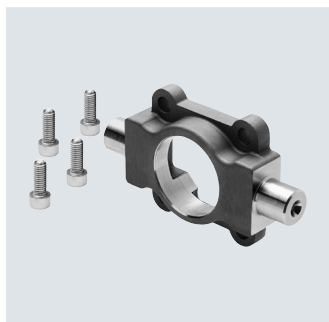

#### Dimensions and ordering data

For $\varnothing$ [mm]	C2)	C3)	TD $\varnothing$ e9	TK	TL	TM	US	XH	XL
32	71	86	12	16	12	50	45	2	58
40	87	105	16	20	16	63	54	4	61.1
50	99	117	16	24	16	75	64	4	64.7
63	116	136	20	24	20	90	75	4	68.5
80	136	156	20	28	20	110	93	5	76.9
100	164	189	25	38	25	132	110	10	95
125	192	217	25	50	25	160	131	14	117

For $\varnothing$ [mm]	Basic version				R3 – High corrosion protection			
	CRC <sup>1)</sup>	Weight [g]	Part no.	Type	CRC <sup>1)</sup>	Weight [g]	Part no.	Type
32	2 - moderate	150	174411	ZNCF-32	4	150	161852	CRZNG-32
40	2 - moderate	285	174412	ZNCF-40	4	285	161853	CRZNG-40
50	2 - moderate	473	174413	ZNCF-50	4	473	161854	CRZNG-50
63	2 - moderate	687	174414	ZNCF-63	4	687	161855	CRZNG-63
80	2 - moderate	1296	174415	ZNCF-80	4	1296	161856	CRZNG-80
100	2 - moderate	2254	174416	ZNCF-100	4	2254	161857	CRZNG-100
125	2 - moderate	3484	174417	ZNCF-125	4	3484	185362	CRZNG-125

1) More information: [www.festo.com/x/topic/crc](http://www.festo.com/x/topic/crc)

## Accessories

## Trunnion support LNZG

Material:

Trunnion support: Anodised aluminium

Plain bearing: Plastic

RoHS-compliant

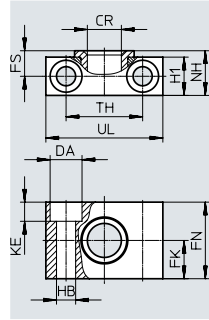
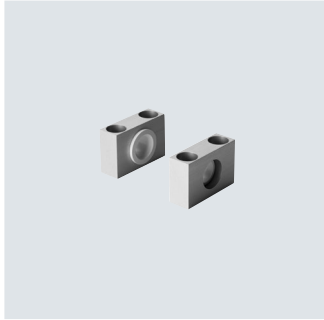

Dimensions and ordering data														Part no.	Type
For $\varnothing$ [mm]	CR $\varnothing$ D11	DA $\varnothing$ H13	FK $\varnothing$ $\pm 0.1$	FN	FS	H1	HB $\varnothing$ H13	KE	NH	TH $\pm 0.2$	UL	CRC <sup>1)</sup>	Weight [g]		
32	12	11	15	30	10.5	15	6.6	6.8	18	32	46	2 - moderate	83	<b>32959</b>	<b>LNZG-32</b>
40, 50	16	15	18	36	12	18	9	9	21	36	55	2 - moderate	129	<b>32960</b>	<b>LNZG-40/50</b>
63, 80	20	18	20	40	13	20	11	11	23	42	65	2 - moderate	178	<b>32961</b>	<b>LNZG-63/80</b>
100, 125	25	20	25	50	16	24.5	14	13	28.5	50	75	2 - moderate	306	<b>32962</b>	<b>LNZG-100/125</b>

1) More information: [www.festo.com/x/topic/crc](http://www.festo.com/x/topic/crc)

## Accessories

### Ordering data – Piston rod attachments

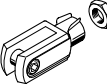
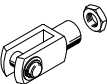
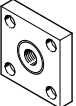
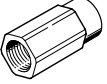
Designation	For ø	Part no.	Type
<b>Rod eye SGS</b>			
	16	★ 9254	SGS-M6
	20, 25	★ 9255	SGS-M8
	32, 40	★ 9261	SGS-M10x1.25
	50, 63	★ 9262	SGS-M12x1.25
	80, 100	★ 9263	SGS-M16x1.5
	125	★ 9264	SGS-M20x1.5
<b>Rod clevis SG</b>			
	12	–	
	16	★ 3110	SG-M6
	20, 25	★ 3111	SG-M8
	32, 40	★ 6144	SG-M10x1.25
	50, 63	★ 6145	SG-M12x1.25
	80, 100	★ 6146	SG-M16x1.5
	125	★ 6147	SG-M20x1.5
<b>Coupling piece KSG</b>			
	12, 16, 20, 25	–	
	32, 40	32963	KSG-M10x1.25
	50, 63	32964	KSG-M12x1.25
	80, 100	32965	KSG-M16x1.5
	125	32966	KSG-M20x1.5
<b>Adapter AD</b>			
	12	–	
	16	157328	AD-M6-M5
		157329	AD-M6-1/8
		157330	AD-M6-1/4
	20	157331	AD-M8-1/8
	25	157332	AD-M8-1/4
	32	157333	AD-M10x1.25-1/8
	40	157334	AD-M10x1.25-1/4
	50	160256	AD-M12x1.25-1/4
	63	160257	AD-M12x1.25-3/8

Datasheets → Internet: piston rod attachment

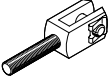
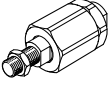
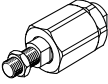
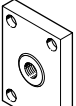
Designation	For ø	Part no.	Type
<b>Rod clevis SGA for rod eye SGS</b>			
	12, 16, 20, 25	–	
	32, 40	32954	SGA-M10x1.25
	50, 63	10767	SGA-M12x1.25
	80, 100	10768	SGA-M16x1.5
	125	10769	SGA-M20x1.5
<b>Self-aligning rod coupler FK</b>			
	12	30984	FK-M5
	16	★ 2061	FK-M6
	20, 25	★ 2062	FK-M8
	32, 40	★ 6140	FK-M10x1.25
	50, 63	★ 6141	FK-M12x1.25
	80, 100	★ 6142	FK-M16x1.5
	125	★ 6143	FK-M20x1.5
<b>Self-aligning rod coupler DARP</b>			
	12	8170112	DARP-M5-F
	16	8170115	DARP-M6-F
	20, 25	8170116	DARP-M8-F
	32, 40	8170119	DARP-M10P-F
	50, 63	8170120	DARP-M12P-F
	80, 100	8170121	DARP-M16P-F
	125	8170124	DARP-M20P-F
<b>Coupling piece KSZ</b>			
	12	–	
	16	36123	KSZ-M6
	20, 25	36124	KSZ-M8
	32, 40	36125	KSZ-M10x1.25
	50, 63	36126	KSZ-M12x1.25
	80, 100	36127	KSZ-M16x1.5
	125	36128	KSZ-M20x1.5



## Accessories

### Ordering data – Piston-rod attachments, corrosion-resistant

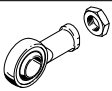
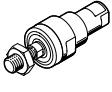
Designation	For ø	Part no.	Type
<b>Rod eye CRSGS</b>			
	12	–	
	16	195580	CRSGS-M6
	20, 25	195581	CRSGS-M8
	32, 40	195582	CRSGS-M10x1.25
	50, 63	195583	CRSGS-M12x1.25
	80, 100	195584	CRSGS-M16x1.5
	125	195585	CRSGS-M20x1.5
<b>Self-aligning rod coupler CRFK</b>			
	32, 40	2305778	CRFK-M10x1.25
	50, 63	2305779	CRFK-M12x1.25
	80, 100	2490673	CRFK-M16x1.5
	125	2545677	CRFK-M20x1.5

Datasheets → Internet: piston rod attachment

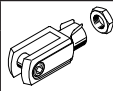
Designation	For ø	Part no.	Type
<b>Rod clevis CRSG</b>			
	12	–	
	16, 20	13567	CRSG-M6
	20, 25	13568	CRSG-M8
	32, 40	13569	CRSG-M10x1.25
	50, 63	13570	CRSG-M12x1.25
	80, 100	13571	CRSG-M16x1.5
	125	13572	CRSG-M20x1.5

### Ordering data – Mounting components

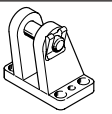
Designation	For ø	Part no.	Type
<b>Right-angle clevis foot LQG for rod eye SGS</b>			
	32, 40	31761	LBG-32
	50, 63	31762	LBG-40
	80, 100	31763	LBG-50
		31764	LBG-63
	125	31765	LBG-80
		31766	LBG-100

Datasheets → Internet: clevis foot

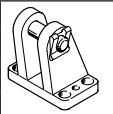
Designation	For ø	Part no.	Type
<b>Right-angle clevis foot LQG for rod eye SGS</b>			
	32, 40	31768	LQG-32
	50, 63	31769	LQG-40
	80, 100	31770	LQG-50
		31771	LQG-63
	125	31772	LQG-80
		31773	LQG-100

### Ordering data – Mounting components, high corrosion protection

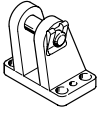
Designation	For ø	Part no.	Type
<b>Clevis foot LBG-R3 for rod eye CRSGS</b>			
	32, 40	2078790	LBG-32-R3
	50, 63	2078792	LBG-40-R3
	80, 100	2078794	LBG-50-R3
		2078795	LBG-63-R3
	125	2078797	LBG-80-R3
		2078799	LBG-100-R3

Datasheets → Internet: clevis foot

### Ordering data – One-way flow control valves

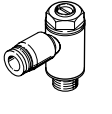
Connection	For ø	For tubing O.D.	Material	Datasheets → Internet: grla	
				Part no.	Type
<b>For exhaust air</b>					
	12, 16, 20, 25	3	Metal design	★ 193137	GRLA-M5-QS-3-D
		4		★ 193138	GRLA-M5-QS-4-D
		6		★ 193139	GRLA-M5-QS-6-D
	32, 40, 50, 63, 80, 100	3		★ 193142	GRLA-1/8-QS-3-D
		4		★ 193143	GRLA-1/8-QS-4-D
		6		★ 193144	GRLA-1/8-QS-6-D
		8		★ 193145	GRLA-1/8-QS-8-D
		6		★ 193146	GRLA-1/4-QS-6-D
	125	8		★ 193147	GRLA-1/4-QS-8-D
		10		★ 193148	GRLA-1/4-QS-10-D

## Accessories

Ordering data – One-way flow control valves					Datasheets → Internet: grlz		
	Connection		Material	Part no.	Type		
	For ø	For tubing O.D.					
<b>For supply air</b>							
	12, 16, 20, 25	3	Metal design	★ 193153	GRLZ-M5-QS-3-D		
		4		★ 193154	GRLZ-M5-QS-4-D		
		6		★ 193155	GRLZ-M5-QS-6-D		
	32, 40, 50, 63, 80, 100	3		★ 193156	GRLZ-1/8-QS-3-D		
		4		★ 193157	GRLZ-1/8-QS-4-D		
		6		★ 193158	GRLZ-1/8-QS-6-D		
		8		★ 193159	GRLZ-1/8-QS-8-D		
	125	–			151195	GRLZ-1/4-B	

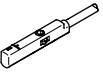
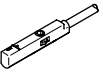

Ordering data – One-way flow control valves for cylinders ADNH and ADN					Datasheets → Internet: grla	
	Connection		Material	Part no.	Type	
	For ø	For tubing O.D.				
<b>For exhaust air</b>						
	25, 40	3	Metal design	193137	GRLA-M5-QS-3-D	
		4		193138	GRLA-M5-QS-4-D	
	63, 100	4		193143	GRLA-1/8-QS-4-D	
		6		193144	GRLA-1/8-QS-6-D	
		8		193145	GRLA-1/8-QS-8-D	

Ordering data – Proximity switch for T-slot, magneto-resistive						Datasheets → Internet: smt	
	Type of mounting	Switching output	Electrical connection	Cable length [m]	Part no.	Type	
<b>N/O</b>							
	Inserted in the slot from above, flush with the cylinder profile, short design	PNP	Cable, 3-core	2.5	★ 574335	SMT-8M-A-PS-24V-E-2.5-OE	
			Plug M8x1, 3-pin	0.3	★ 574334	SMT-8M-A-PS-24V-E-0.3-M8D	
			Plug M12x1, 3-pin	0.3	★ 574337	SMT-8M-A-PS-24V-E-0.3-M12	
		NPN	Cable, 3-core	2.5	★ 574338	SMT-8M-A-NS-24V-E-2.5-OE	
			Plug M8x1, 3-pin	0.3	★ 574339	SMT-8M-A-NS-24V-E-0.3-M8D	
<b>N/C</b>							
	Inserted in the slot from above, flush with the cylinder profile, short design	PNP	Cable, 3-core	7.5	★ 574340	SMT-8M-A-PO-24V-E-7.5-OE	

Ordering data – Proximity switch for T-slot, magneto-resistive						Datasheets → Internet: smt	
	Type of mounting	Electrical connection, outlet direction of connection	Switching output	Cable length [m]	Part no.	Type	
<b>N/O</b>							
	Inserted into the slot lengthwise	Cable, 3-core, crosswise	PNP	2.5	547859	SMT-8G-PS-24V-E-2.5Q-OE	
		Plug M8x1, 3-pin, crosswise		0.3	547860	SMT-8G-PS-24V-E-0.3Q-M8D	
		Cable, 3-core, crosswise	NPN	2.5	8065028	SMT-8G-NS-24V-E-2.5Q-OE	
		Plug M8x1, 3-pin, crosswise		0.3	8065027	SMT-8G-NS-24V-E-0.3Q-M8D	

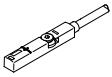
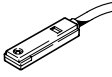
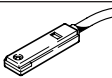
## Accessories

Ordering data – Proximity switches for T-slot, magnetic reed						Datasheets → Internet: sme
	Type of mounting	Switching output	Electrical connection	Cable length [m]	Part no.	Type
<b>N/O</b>						
	Inserted in the slot from above, flush with the cylinder profile	Contacting	Cable, 3-core	2.5	★ 543862	SME-8M-DS-24V-K-2.5-OE
				5.0	★ 543863	SME-8M-DS-24V-K-5.0-OE
			Plug M8x1, 3-pin	2.5	★ 543872	SME-8M-ZS-24V-K-2.5-OE
				0.3	★ 543861	SME-8M-DS-24V-K-0.3-M8D
	Inserted in the slot lengthwise, flush with the cylinder profile	Contacting	Cable, 3-core	2.5	150855	SME-8-K-LED-24
			Plug M8x1, 3-pin	0.3	150857	SME-8-S-LED-24
<b>N/C</b>						
	Inserted in the slot lengthwise, flush with the cylinder profile	Contacting	Cable, 3-core	7.5	160251	SME-8-O-K-LED-24



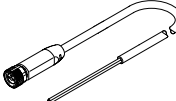

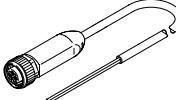
Ordering data – Connecting cables						Datasheets → Internet: nebu
	Electrical connection, left	Electrical connection, right	Cable length [m]	Part no.	Type	
	Straight socket, M8x1, 3-pin	Cable, open end, 3-core	2.5	★ 541333	NEBU-M8G3-K-2.5-LE3	
			5	★ 541334	NEBU-M8G3-K-5-LE3	
	Straight socket, M12x1, 5-pin	Cable, open end, 3-core	2.5	★ 541363	NEBU-M12G5-K-2.5-LE3	
			5	★ 541364	NEBU-M12G5-K-5-LE3	
	Angled socket, M8x1, 3-pin	Cable, open end, 3-core	2.5	★ 541338	NEBU-M8W3-K-2.5-LE3	
			5	★ 541341	NEBU-M8W3-K-5-LE3	
	Angled socket, M12x1, 5-pin	Cable, open end, 3-core	2.5	541367	NEBU-M12W5-K-2.5-LE3	
			5	541370	NEBU-M12W5-K-5-LE3	

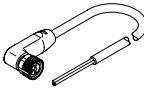
Connecting cables NEBA, straight, connection M8						
	Electrical connection 1, connector system	Electrical connection 2, connector system	Electrical connection 2, number of connections/cores	Cable length	Part no.	Type
	M8x1, A-coded, to EN 61076-2-104	Open end	3	2.5 m	★ 8078223	NEBA-M8G3-U-2.5-N-LE3
				5 m	★ 8078224	NEBA-M8G3-U-5-N-LE3

Connecting cables NEBA, straight, connection M12						
	Electrical connection 1, connector system	Electrical connection 2, connector system	Electrical connection 2, number of connections/cores	Cable length	Part no.	Type
	M12x1, A-coded to EN 61076-2-101	Open end	3	2.5 m	★ 8078236	NEBA-M12G5-U-2.5-N-LE3
				5 m	★ 8078237	NEBA-M12G5-U-5-N-LE3

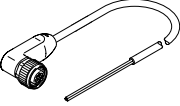
Connecting cables NEBA, angled, connection M8						
	Electrical connection 1, connector system	Electrical connection 2, connector system	Electrical connection 2, number of connections/cores	Cable length	Part no.	Type
	M8x1, A-coded, to EN 61076-2-104	Open end	3	2.5 m	★ 8078230	NEBA-M8W3-U-2.5-N-LE3
				5 m	★ 8078231	NEBA-M8W3-U-5-N-LE3

## Accessories

Connecting cables NEBA, angled, connection M12						
	Electrical connection 1, connector system	Electrical connection 2, connector system	Electrical connection 2, number of connections/cores	Cable length	Part no.	Type
	M12x1, A-coded to EN 61076-2-101	Open end	3	2.5 m	<b>8078245</b>	<b>NEBA-M12W5-U-2.5-N-LE3</b>
				5 m	<b>8078246</b>	<b>NEBA-M12W5-U-5-N-LE3</b>
Ordering data – Proximity switch, cuboid shape, pneumatic					Datasheets → Internet: smpo	
	Pneumatic connection				Part no.	Type
3/2-way valve, normally closed						
	Female thread M5				<b>178563</b>	<b>SMPO-8E</b>
Ordering data – Mounting kit for proximity switch SMPO-8E					Datasheets → Internet: smb	
	Assembly				Part no.	Type
	Clamped in T-slot				<b>178230</b>	<b>SMB-8E</b>
Ordering data – Slot cover for T-slot						
	Assembly	Length			Part no.	Type
	Insertable	2x 0.5 m			<b>151680</b>	<b>ABP-5-S</b>