

## Solenoid valves VUVG-F1A/valve terminals VTUG-F1A

**FESTO**

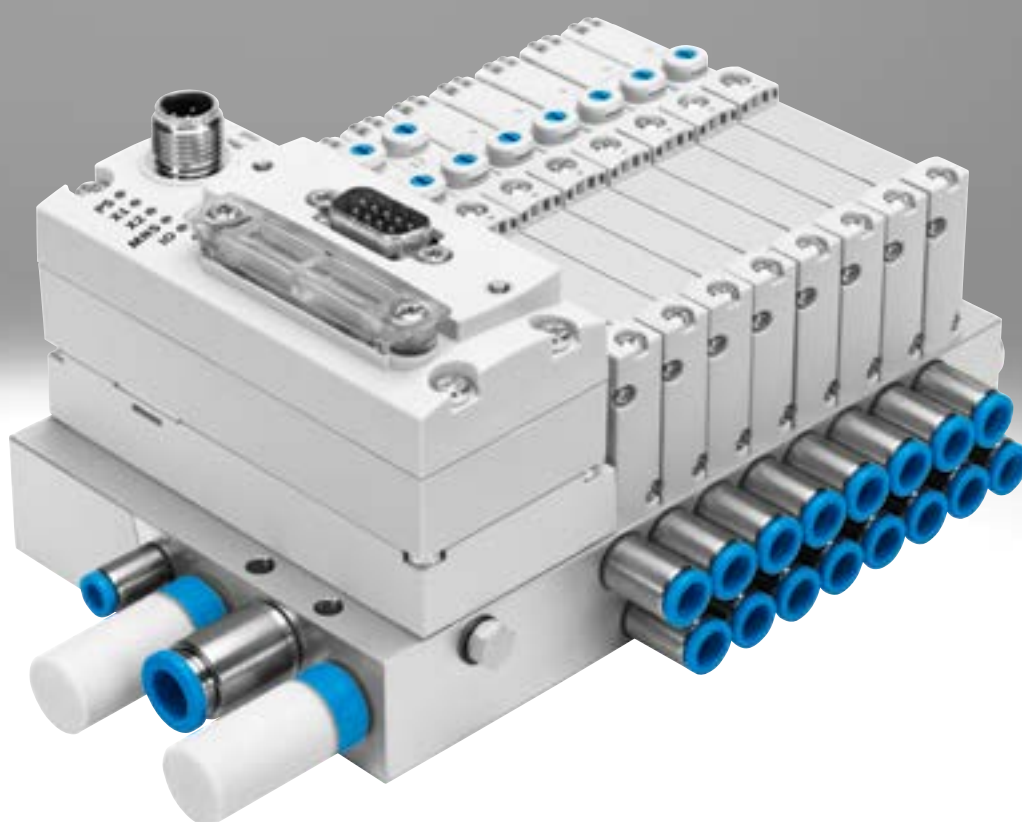

## Key features

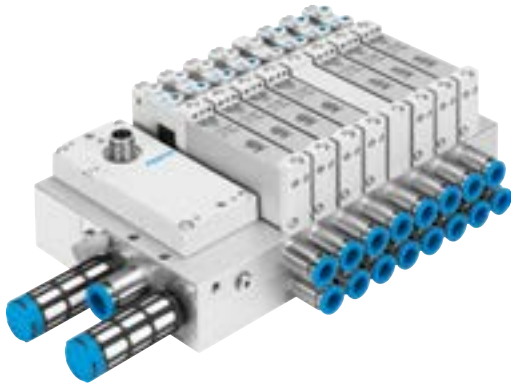

### Innovative

- Festo-specific I-Port interface for bus nodes (CTEU)
- IO-Link® mode for direct connection to a higher-level IO-Link master
- Flexible multi-pin plug connection using Sub-D or ribbon cable
- Reversible piston spool valves, up to 24 valve positions
- Reduced power consumption
- Excellent price/performance ratio

### Versatile

- Choice of quick push-in connectors
- Multiple pressure zones possible
- Sub-D variant and fieldbus interface with protection to IP67
- Internal or external pilot air with the same manifold rail possible by using blanking plugs
- Sub-base valves with working ports underneath for installation in control cabinets

### Reliable

- Sturdy and durable metal components
  - Valves
  - Manifold rails
- Fast troubleshooting thanks to LED indicator
- Manual override: choose from non-detenting, detenting or covered

### Easy to install

- Easy to mount thanks to captive screws and seal
- Easy-to-change connection technology
- Inscription label holder for labelling

### Ordering data – Product options

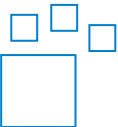

Configurable product

This product and all its product options can be ordered using the configurator.

The configurator can be found at

→ [www.festo.com/catalogue/...](http://www.festo.com/catalogue/...)

Enter the part number or the type.

Part no.

8143237

Type

VTUG-F1A

## Key features

### Sub-base valves for valve terminal VTUG-F1A

VUVG-B...1T1, sub-base valve

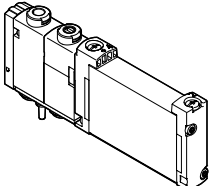

In the case of sub-base valves, the supply ports (1, 3 and 5) and the working ports (2, 4) are connected to the valve via pneumatic links (e.g. sub-base).

### Overview – Valve terminal with multi-pin plug connection and fieldbus interface

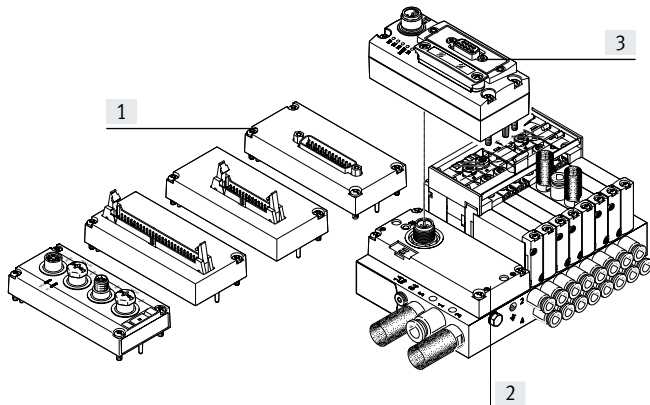

Different electrical connections:

- [1] Ribbon cable or Sub-D
- [2] I-Port interface
- [3] Bus node CTEU

## Key features

### Equipment options

#### Valve functions

- 2x 3/2-way, 3/2-way, 5/2-way, 5/3-way valves
- Reversible piston spool valves, up to 24 valve positions

#### Electrical connection options

- IO-Link® mode for direct connection to a higher-level IO-Link master
- Festo-specific I-Port interface for bus nodes (CTEU)
- Flexible multi-pin plug connection using Sub-D or ribbon cable

### Basic valves VUVG-F1A

#### Size

- 10
- 14

#### Variants

- Sub-base valve

### Valve functions

#### 3/2-way valve

- Single solenoid
- Normally open
- Normally closed

#### 2x 3/2-way valve

- Single solenoid
- Normally open
- Normally closed
- 1x normally closed, 1x normally open
- Mechanical spring
- Pneumatic spring

#### 5/2-way valve

- Single solenoid
- Pneumatic/mechanical spring
- Mechanical spring
- Pneumatic spring
- Double solenoid valve

#### 5/3-way valve

- Mid-position pressurised
- Mid-position exhausted
- Mid-position closed

### Cover caps for manual override

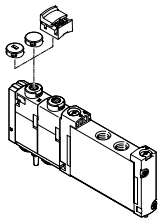

- Closed cover cap, covered manual override
- Slotted cover cap, non-detenting manual override
- Cover cap for detenting actuation without tools

### Inscription label holders

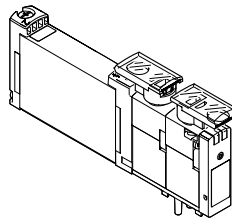

Inscription label holders ASLR-D-L1 for identifying the valves and as a covering for the manual override.

### Inscription label holders

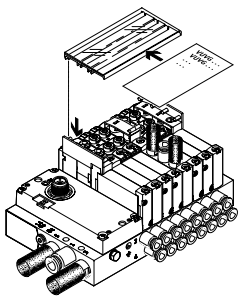

Inscription label holders ASCF-H-L1-... for identifying the valves on the valve terminal VTUG

## Key features – Pneumatic components

### Manifold rail

For sub-base valves

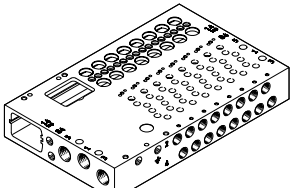

The sub-base valves are supplied with external pilot air. The pilot air is set via the manifold rail. The scope of delivery of the manifold rail includes a short and a long blanking plug for setting the pilot air.

- For sub-base valves M5/M7 (size 10), G1/8 (size 14)
- For 2x 3/2-way, 3/2-way, 5/2-way and 5/3-way valves
- 4 to 24 valve positions with electrical links

## Key features

### Electrical connection

#### Multi-pin plug connection

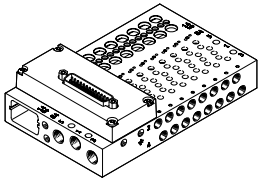

The signals are transmitted from the controller to the valve terminal via a pre-assembled or self-assembled multi-wire cable to the multi-pin plug connection.

This substantially reduces installation time compared to individually connected valves. The valve terminal can be equipped with max. 48 solenoid coils.

Versions:

- Sub-D connection
- Ribbon cable

### I-Port interface

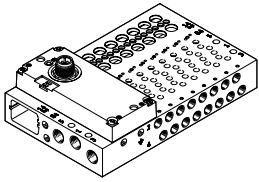

Festo-specific interface as a basis for bus nodes (CTEU) or in IO-Link® mode for direct connection to a higher-order IO-Link master.

Communication and power supply take place via a common M12 interface.

Connection options:

- As I-Port interface for bus nodes (CTEU)
- In IO-Link® mode for direct connection to an IO-Link master

### Supply plate

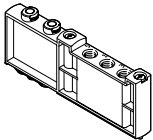

For additional air supply and exhaust via a valve position (ports for duct 1, 3 and 5).



#### Note

The supply plate VABF-L1-14-P3A4-G18-T1 can only be used with G fittings. R fittings are not permissible.

### Cover plate for vacant position

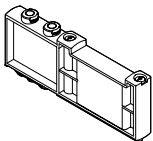

Vacant position cover



### Separator for pressure zones

For creating multiple pressure zones in a valve terminal

## Key features – Pneumatic components

### Creating pressure zones and separating exhaust air

Compressed air is supplied and exhausted via the manifold rail and via supply plates.

The position of the supply plates and duct separations can be freely selected with the VTUG.







A pressure zone is created by separating the internal supply ducts using a separator.

Pressure zone separation can be used for the following ducts:

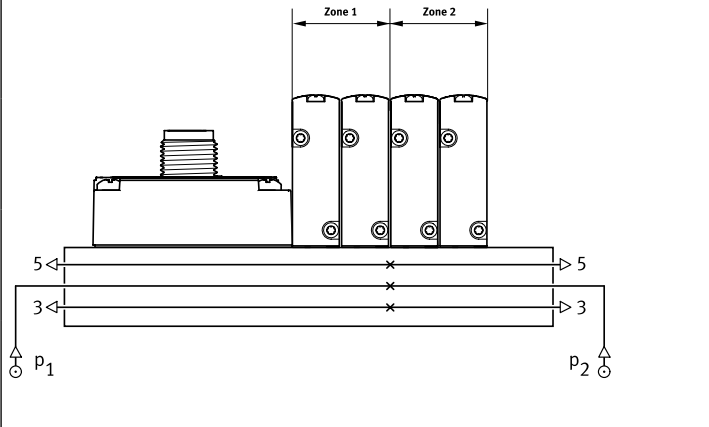
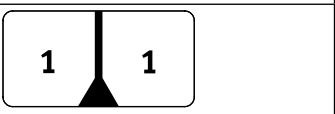
- Duct 1
- Duct 3
- Duct 5

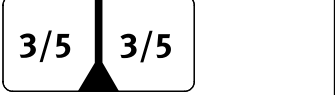
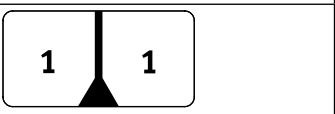
 **Note**

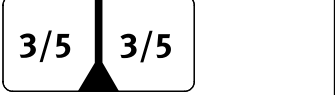
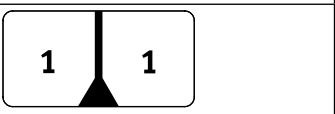
- Use a separator if the exhaust air pressures are high
- Use at least one supply plate/air supply for each pressure zone
- Pressure zone separation is not possible in duct 12/14 (pilot air supply)

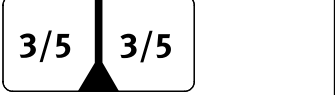
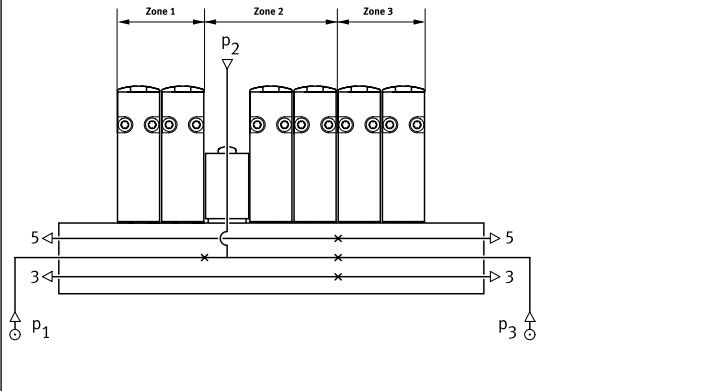
Duct separation	Description						
	<p>The pressure zones can be freely configured with the VTUG. The following duct separations are possible:</p> <table border="1" data-bbox="833 806 1513 1137"> <tr> <td data-bbox="833 806 1173 918">Duct 1 closed</td> <td data-bbox="1177 806 1513 918">  </td> </tr> <tr> <td data-bbox="833 925 1173 1037">Duct 1, 3, 5 closed</td> <td data-bbox="1177 925 1513 1037">  </td> </tr> <tr> <td data-bbox="833 1043 1173 1137">Duct 3, 5 closed</td> <td data-bbox="1177 1043 1513 1137">  </td> </tr> </table>	Duct 1 closed		Duct 1, 3, 5 closed		Duct 3, 5 closed	
Duct 1 closed							
Duct 1, 3, 5 closed							
Duct 3, 5 closed							
	<p>The number of pressure zones with the VTUG is limited by the number of valve positions on the manifold rail. Note that each supply plate occupies one valve position.</p>						

### Separator VABD

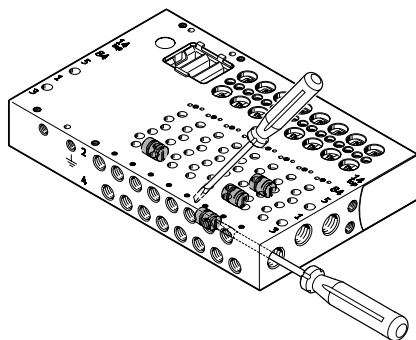

[1] Separator VABD

 **Note**

With the VTUG, several pressure zones can be created by mounting separators (VABD). The separators are inserted in the manifold rail using a slotted screwdriver.

## Key features – Pneumatic components

### Pilot air supply

#### Internal pilot air supply

Internal pilot air supply can be chosen with an operating pressure between 1.5 ... 8 bar, 2.5 ... 8 bar, or 3 ... 8 bar (depending on the valve used).

The pilot air supply is branched from duct 1 (compressed air supply) using an internal connection.

#### External pilot air supply

External pilot air supply is required for vacuum operation or operating pressures above 8 bar. The port for external pilot air supply (port 12/14) is located on the manifold rail.

#### Pilot exhaust air

The pilot air is exhausted via duct 82/84 of the manifold rail.

### Pilot air supply

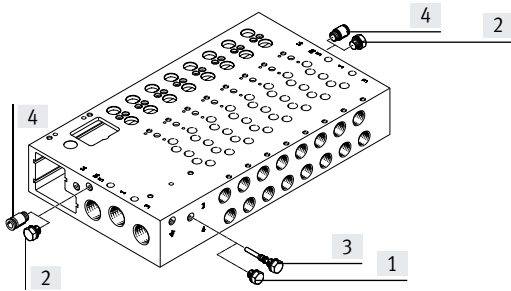

- [1] Blanking plug, short, for internal pilot air
- [2] Blanking plug for duct 12/14 with internal pilot air
- [3] Blanking plug, long, for external pilot air
- [4] Push-in fitting for duct 12/14 with external pilot air

The manifold rails have an internal connection between duct 12/14 and duct 1. By inserting a blanking plug into this connection, it is possible to switch between internal and external pilot air.



## Key features – Pneumatic components

### Operation with different pressures

#### Vacuum operation

#### Points to note with 3/2-way valves with pneumatic spring return:

The 3/2-way valves are available in a design with two valves in one valve body and with pneumatic spring return. With these valves, the force for the return movement is obtained from port 1.

Vacuum operation is only possible at port 3 and 5, not at port 1. With external pilot air supply, vacuum can be connected at port 1, 3, 5 of the 5/2-way and 5/3-way valves.

Vacuum operation is not possible when using the shut-off function (hot swap).

#### Reverse operation

The 3/2-way valves with pneumatic spring are not suitable for reverse operation, since at least the minimum pilot pressure must be present in duct 1.

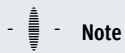

#### Note

Pressure must be present at port 1.

#### Pressure divider (internal pilot air)

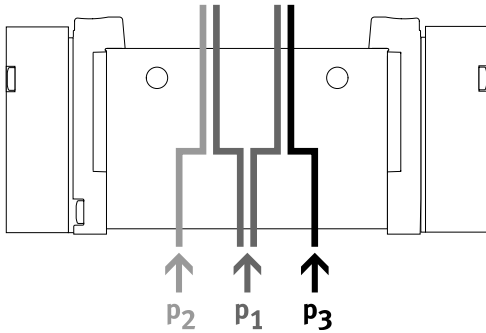

- Two different pressures are required
- Different pressures can be connected at duct 1, 3 and 5

#### Advantages

Any pressure or vacuum can be connected at duct 3 and 5 both with external and internal pilot air



#### Note

- With internal pilot air, adhere to the minimum pilot pressure in duct 1
- With 2x 3/2-way valves without spring return, to the minimum pilot pressure in duct 1

#### Vacuum, ejector pulse and normal position

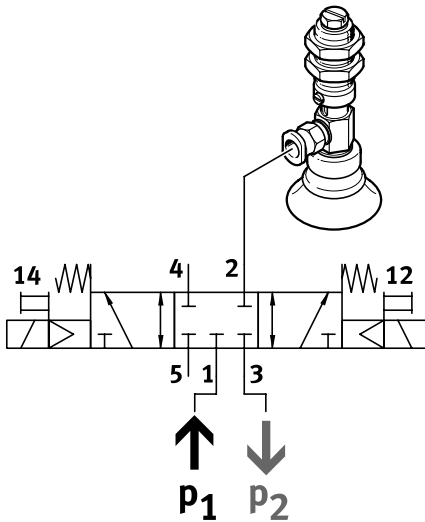

Vacuum, ejector pulse and normal position with internal pilot air can be achieved by connecting vacuum at duct 3 and pressure for the ejector pulse at duct 1.

### Key features – Pneumatic components

#### Standard nominal flow rate $q_{nN}$ as a function of the number of switched valves $n$

Size 10 mm, 5/2-way valves

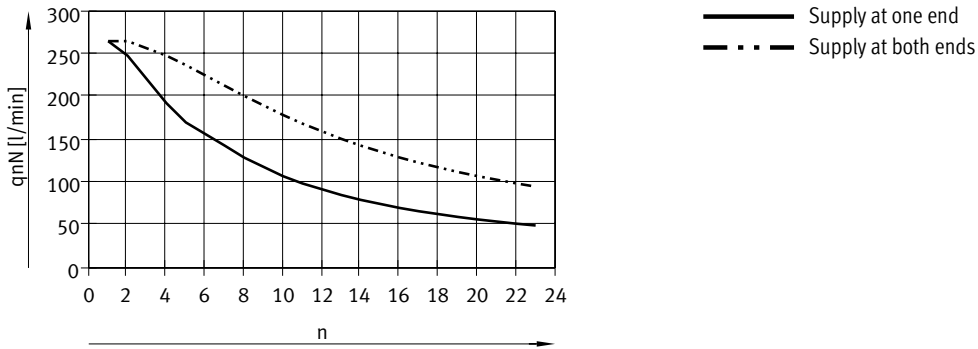

Size 14 mm

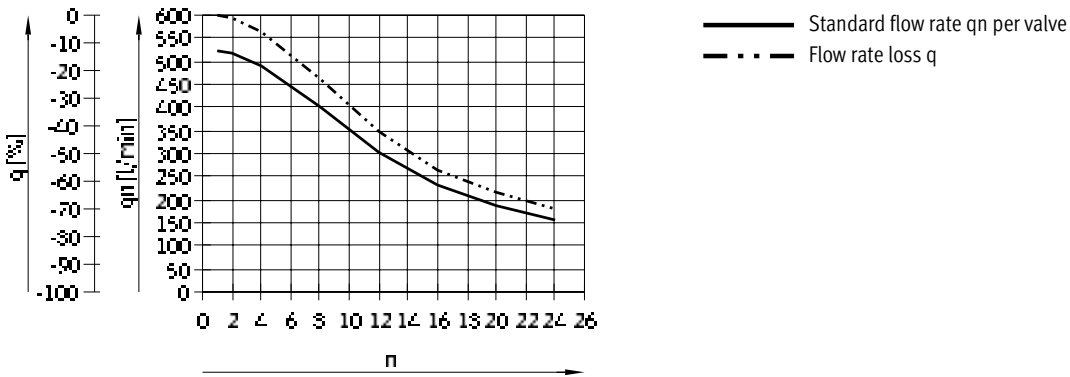

## Key features – Pneumatic components

### Pilot pressure p2 as a function of operating pressure p1

2x 3/2-way valve, mechanical spring return

2x 3/2-way valve, pneumatic spring return

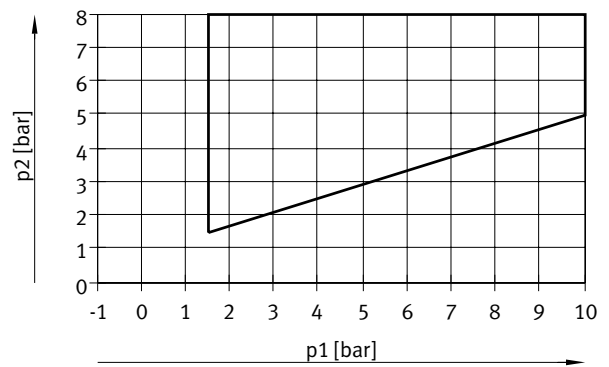
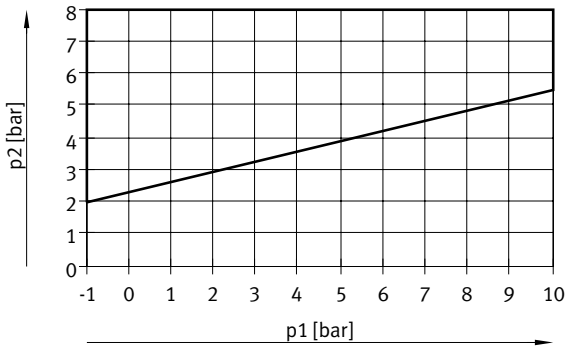

3/2-way single solenoid valve and 5/2-way single solenoid valve

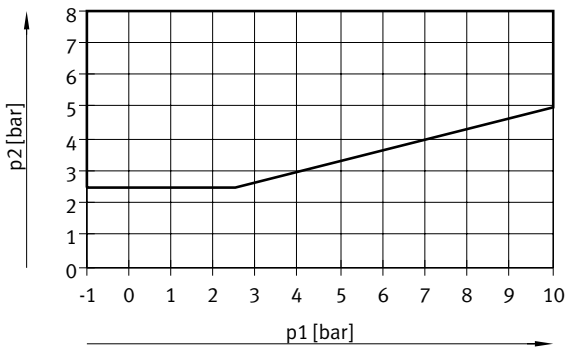

## Key features – Mounting

### Valve terminal mounting

Sturdy terminal mounting via:

- Four through-holes for wall mounting
- H-rail mounting
- Mounting bracket



Use the M5 thread provided on the manifold block for earthing the valve terminal.

### Wall mounting

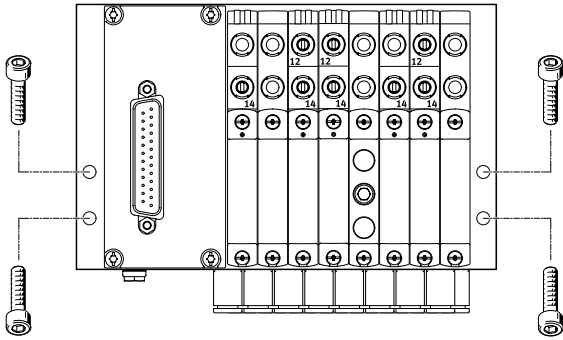

Screw the valve terminal VTUG onto the mounting surface using four M4 screws.

The mounting holes are on the left and right side of the manifold rail.

### H-rail mounting

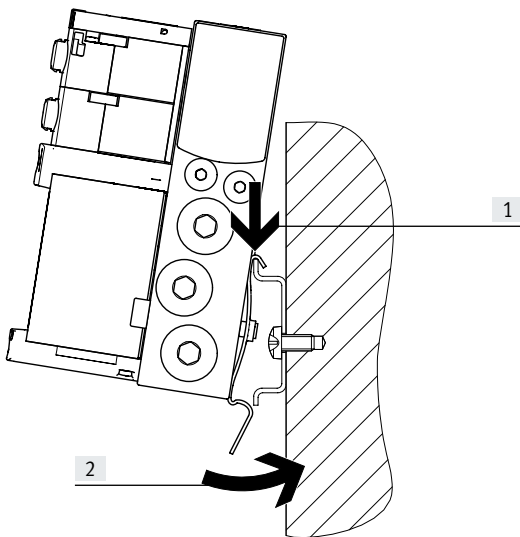

Clip the valve terminal VTUG onto the H-rail (see arrow [1]).

Swivel the valve terminal onto the H-rail and secure in place with the clamping element (see arrow [2]).

Attach the manifold rails to a rail to EN 60715-TH35 using the H-rail mounting VAME-T-M4.

Use the following screws for mounting (to DIN 912):

- Size 10: M4x30
- Size 14: M4x40

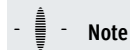

Permissible use of the H-rail:

- Manifold rail with outlet on the side or on top.
  - H-rail exclusively for horizontal mounting.
  - Vibration/shock loads are not permissible for this type of mounting.
- Size 14:
- Use H-rail type TH35-7.5 for valve terminals with a maximum of 8 valve positions.
  - Use H-rail type TH35-15 for mounting in accordance with the standard and for more than 8 valve positions.

## Key features – Mounting

### Manual override (MO)

#### MO with automatic return (non-detenting)

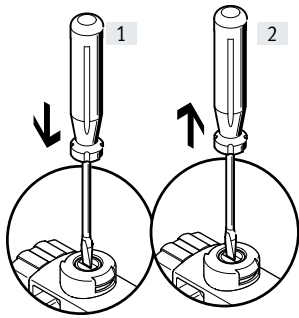

- [1] Press in the plunger of the MO with a pointed object or screwdriver.  
The pilot valve switches and actuates the main valve.
- [2] Remove the pointed object or screwdriver.  
The spring force pushes the plunger of the manual override back.  
The pilot valve returns to its normal position as does the main single solenoid valve (not the case with double solenoid valve code J).

#### MO with locking (detenting)

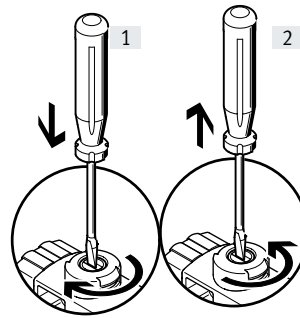

- [1] Press in the plunger of the MO with a pointed object or screwdriver until the valve switches and then turn the plunger 90° clockwise until the stop is reached.  
The valve remains actuated
- [2] Turn the plunger 90° anti-clockwise until the stop is reached and then remove the pointed object or screwdriver. The spring force pushes the plunger of the manual override back.  
The valve returns to its normal position (not with double solenoid valve code J).

#### MO non-detenting – with coded cover cap

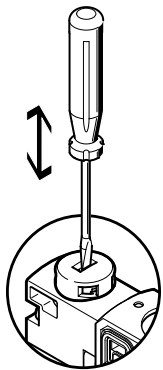

MO is actuated by pushing it with a pointed object or screwdriver and reset by spring force (detenting position prevented by coded cover cap).

#### MO detenting without tools – mounting

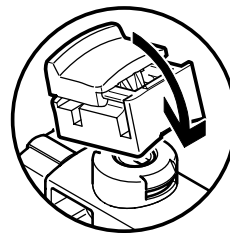

Turn MO to clip it onto the pilot valve. The cap for the MO can then be operated (detenting) without tools.

#### MO detenting without tools – actuation

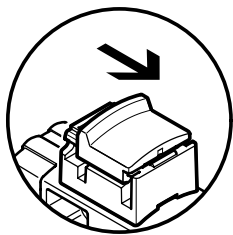

Sliding the cap for the MO with latch in the direction of the arrow results in:

- Cap locks into the end position
- The pilot valve switches and actuates the main valve.

#### MO detenting without tools – actuation

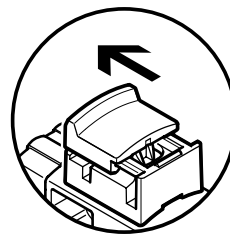

Sliding the cap for the MO with latch in the direction of the arrow results in:

- Cap locks into the end position
- The spring force pushes the plunger of the manual override back.
- The pilot valve returns to its normal position as does the main single solenoid valve (not the case with double solenoid valve code J).

## Key features – Mounting

### Inscription system

#### Inscription label holders

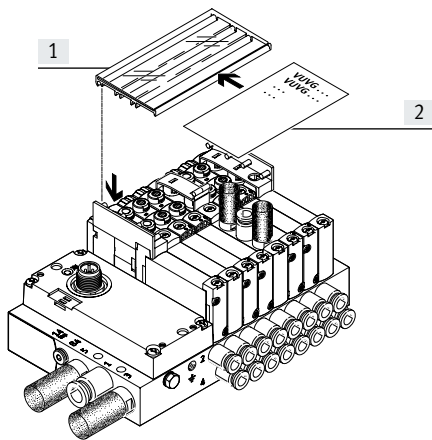

- [1] Inscription label holders  
ASCF-H-L1 (code TT)
- [2] Inscription field

Mount the inscription label holders to label the valves. Open the inscription label holder to insert the inscription label and actuate the manual override. The inscription label holders are available in different sizes depending on the number of valve positions.

#### Note

Do not engage the manual override before mounting the inscription label holder. When mounted, the retaining bracket for the inscription label holder covers the manual override of the valves beneath it. The manual override for the two valves under the retainers of the inscription label holder can then only be operated as non-detenting.

#### Inscription label holders

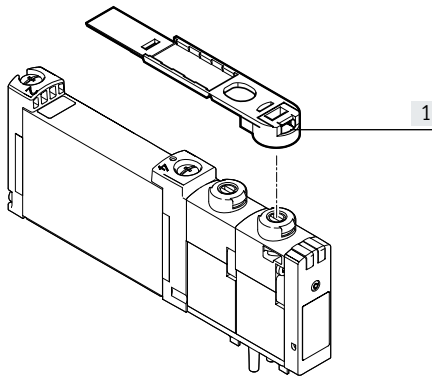

- [1] Inscription label holders  
ASLR-D-L1 (code TV)

Use inscription label holders ASLR-D-L1 (code TV) to label individual valves. The inscription label holder is placed directly on the manual override.

#### Note

Do not engage the manual override before mounting the inscription label holder. After the retaining brackets are fitted, the manual override can only be operated as non-detenting.

## Overview of valve functions

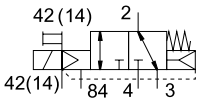
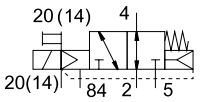
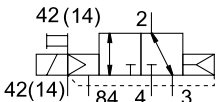
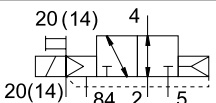
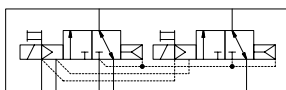
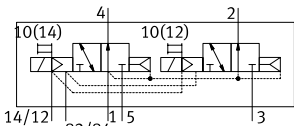
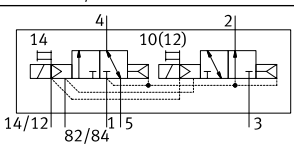
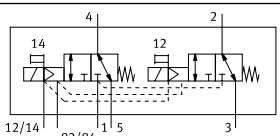
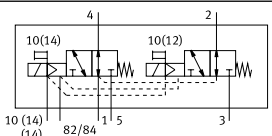
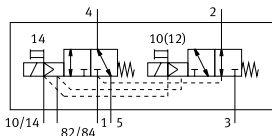
Valve	Valve code	Description	Size	
			M5/M7	G1/8
<b>3/2-way valve, pneumatic/mechanical spring</b>				
	M32C-R	Normally closed	■	–
	M32U-R	Normally open	■	–
<b>3/2-way valve, pneumatic spring</b>				
	M32C-A	Normally closed	–	■
	M32U-A	Normally open	–	■
<b>2x 3/2-way valve, pneumatic spring</b>				
	T32C-A	Normally closed	■	■
	T32U-A	Normally open	■	■
	T32H-A	1x normally open, 1x normally closed	■	■
<b>2x 3/2-way valve, mechanical spring</b>				
	T32C-M	Normally closed	■	■
	T32U-M	Normally open	■	■
	T32H-M	1x normally open, 1x normally closed	■	■

Overview of valve functions

Valve	Valve code	Description	Size	
			M5/M7	G1/8
<b>5/2-way valve, double solenoid</b>				
	B52	External pilot air supply	■	■
<b>5/2-way valve, single solenoid</b>				
	M52-A	Pneumatic spring	-	■
	M52-M	Mechanical spring	■	■
	M52-R	Pneumatic/mechanical spring	■	-
<b>5/3-way valve</b>				
	P53C	Mid-position closed	■	■
	P53U	Mid-position pressurised	■	■
	P53E	Mid-position exhausted	■	■



## Type codes -F1A

<b>001</b>	<b>Series</b>	
<b>VTUG</b>	Valve terminal	
<b>002</b>	<b>Size</b>	
<b>10</b>	Size 10	
<b>14</b>	Size 14	
<b>003</b>	<b>Valve control</b>	
<b>M</b>	Multi-pin	
<b>V</b>	Interface for fieldbus module	
<b>004</b>	<b>Multi-pin plug connection type</b>	
<b>SD</b>	Sub-D plug	
<b>005</b>	<b>Circuitry</b>	
<b>R</b>	Holding current reduction with integrated protective circuit	
<b>006</b>	<b>Bus protocol/activation</b>	
	None	
<b>AP</b>	CPX-AP interface	
<b>LK</b>	IO-Link®	
<b>PT</b>	I-Port interface	
<b>007</b>	<b>Valve type</b>	
<b>B</b>	Sub-base valve	
<b>008</b>	<b>Nominal operating voltage</b>	
<b>1</b>	24 V DC	
<b>009</b>	<b>Manual override</b>	
<b>H</b>	Non-detenting	
<b>S</b>	Covered	
<b>T</b>	Non-detenting, detenting with accessories	
<b>Y</b>	Detenting	
<b>010</b>	<b>Pilot air</b>	
	Internal	
<b>Z</b>	External	
<b>011</b>	<b>Number of pins</b>	
	None	
<b>25</b>	25-pin	
<b>44</b>	44-pin	
<b>012</b>	<b>Pin allocation</b>	
	Standard	
<b>V20</b>	For 12 double solenoid/bistable or 24 single solenoid/monostable valves	
<b>V21</b>	For 18 double solenoid/bistable and 6 single solenoid/monostable valves	
<b>V22</b>	For 10 double solenoid/bistable valves	
<b>V23</b>	For 8 double solenoid/bistable and 4 single solenoid/monostable valves	
<b>V24</b>	For 4 double solenoid/bistable and 12 single solenoid/monostable valves	
<b>V25</b>	For 20 single solenoid/monostable valves	
<b>013</b>	<b>Compressed air supply connection</b>	
<b>Q6</b>	Push-in connector 6 mm	
<b>Q8</b>	Push-in connector 8 mm	
<b>Q10</b>	Push-in connector 10 mm	
<b>Q12</b>	Push-in connector 12 mm	
<b>G18</b>	G1/8	
<b>G14</b>	G1/4	
<b>014</b>	<b>Compressed air supply connection position</b>	
	Both sides	
<b>L</b>	Left	
<b>R</b>	Right	
<b>015</b>	<b>Exhaust connection</b>	
<b>DQ</b>	Push-in fitting	
<b>DT</b>	Thread	
<b>UC</b>	Silencer	
<b>016</b>	<b>Exhaust connection position</b>	
	Both sides	
<b>L</b>	Left	
<b>R</b>	Right	
<b>017</b>	<b>Valve connection</b>	
<b>C</b>	Blanking plug	
<b>G18</b>	G1/8	
<b>M5</b>	M5	
<b>M7</b>	M7	
<b>Q4</b>	Push-in connector 4 mm	
<b>QH4</b>	Push-in connector 4 mm, with connecting thread M7	
<b>Q6</b>	Push-in connector 6 mm	
<b>QH6</b>	Push-in connector 6 mm, with connecting thread M7	
<b>Q8</b>	Push-in connector 8 mm	
<b>018</b>	<b>Push-in connection type</b>	
<b>S</b>	Screwed	
<b>019</b>	<b>Position function</b>	
<b>A</b>	5/2 or 4/2-way valve, single solenoid/monostable, mechanical spring	
<b>B</b>	5/3- or 4/3-way valve, mid-position pressurised	
<b>E</b>	5/3 or 4/3-way valve, mid-position exhausted	
<b>G</b>	5/3 or 4/3-way valve, mid-position closed	
<b>H</b>	2x3/2-way valve, 1x normally closed, 1x normally open, pneumatic spring	
<b>J</b>	4/2 or 5/2-way double pilot valve	
<b>K</b>	1x3/2 or 2x3/2-way valve, normally closed, pneumatic spring	
<b>L</b>	Vacant position	
<b>M</b>	4/2 or 5/2-way valve, single solenoid/monostable, pneumatic spring	
<b>N</b>	1x3/2 or 2x3/2-way valve, normally open, pneumatic spring	
<b>P</b>	5/2-way valve, single solenoid/monostable, pneumatic/mechanical spring	
<b>S</b>	Additional power supply	
<b>VH</b>	2x3/2-way valve, 1x normally closed, 1x normally open, mechanical spring	
<b>VK</b>	2x3/2-way valve, normally closed, mechanical spring	
<b>VN</b>	2x3/2-way valve, normally open, mechanical spring	

Type codes -F1A

020	Working port, duct 2
	As selected
CC	Blanking plug
QG18	G1/8
QM5	M5
QM7	M7
Q4	Push-in connector, 4 mm
QH4	Push-in connector 4 mm, with connecting thread M7
Q6	Push-in connector 6 mm
QH6	Push-in connector 6 mm, with connecting thread M7
Q8	Push-in connector 8 mm

021	Working port, duct 4
	As selected
XCC	Blanking plug
XQG18	G1/8
XQM5	M5
XQM7	M7
XQ4	Push-in connector 4 mm
XQH4	Push-in connector 4 mm, with connecting thread M7
XQ6	Push-in connector 6 mm
XQH6	Push-in connector 6 mm, with connecting thread M7
XQ8	Push-in connector 8 mm

022	Special material properties
F1A	Recommended for production plants for manufacturing lithium-ion batteries, F1A

023	Certification
	None
NA4X	NEMA 4X

024	Accessories for IO-Link®
	None
XM	T-adapter, M12, 5-pin, for IO-Link® and load supply

025	Accessories for IO-Link®, separate load supply
	None
XN	Straight plug, M12, 5-pin

026	Electrical accessories
	None
M1	Connecting cable, multi-pin, 2.5 m
M2	Connecting cable, multi-pin, 5 m
M3	Connecting cable, multi-pin, 10 m
MA1	Connecting cable, multi-pin, angled, 2.5 m
MA2	Connecting cable, multi-pin, angled, 5 m
MA3	Connecting cable, multi-pin, angled, 10 m

027	Inscription label holder for valves
	None
TV	Transparent, valve
TT	Transparent, valve terminal

028	Copper content
	Standard
F	Free of copper

## Datasheet – Sub-base valve M5/M7

## Function

3/2C, 3/2U

2x 3/2C, 2x 3/2U, 2x 3/2H

5/2-way, single solenoid

5/2-way, double solenoid

5/3C, 5/3U, 5/3E

 - Size 10 mm

 - Flow rate  
130 ... 300 l/min

 - Voltage  
24 V DC

Circuit diagrams → page 15

General technical data														
Valve function	T32-A			T32-M			M32-R		M52-R	B52	M52-M	P53		
Normal position	C <sup>1)</sup>	U <sup>2)</sup>	H <sup>4)</sup>	C <sup>1)</sup>	U <sup>2)</sup>	H <sup>4)</sup>	C <sup>1)</sup>	U <sup>2)</sup>	–	–	–	C <sup>1)</sup>	U <sup>2)</sup>	E <sup>3)</sup>
Stable position	Monostable									Bistable		Monostable		
Pneumatic spring return	Yes			No			No	Yes <sup>5)</sup>	–	–	No	–		
Mechanical spring return	No			Yes			Yes	Yes <sup>5)</sup>	–	–	Yes	Yes		
Vacuum operation at port 1	No			With external pilot air										
Design	Piston spool													
Sealing principle	Soft													
Actuation type	Electrical													
Type of control	Piloted													
Pilot air supply	External													
Exhaust air function	Can be throttled													
Manual override	Choice of non-detenting, covered, non-detenting/detenting or detenting													
Type of mounting	On manifold rail													
Mounting position	Any													
Overlap	Positive overlap											Indeterminate overlap		
Signal status indication	LED													
Standard nominal flow rate M5/M7	[l/min]	160	140	140	140	300	260	260						
Flow rate on manifold rail M5, front	[l/min]	150	130	130	130	220	220	200						
Flow rate on manifold rail M7, front	[l/min]	160	140	140	140	270	240	250						
Flow rate on manifold rail M7, underneath	[l/min]	160	140	140	140	300	260	260						
Size	[mm]	10												
Connection	1, 3, 5, 12/14, 82/84	On manifold rail												
	2, 4	On manifold rail												
Product weight	[g]	59					53		60	53	58			
Certification	c UL us - Recognized (OL)													
	RCM													
CE marking (see declaration of conformity) <sup>6)</sup>	To EU EMC Directive													
Corrosion resistance class CRC <sup>7)</sup>	2													

1) C=Normally closed/mid-position closed

2) U=Normally open/mid-position pressurised

3) E=Mid-position exhausted

4) H=2x 3/2-way valve in one housing with 1x normally closed and 1x normally open

5) Combined reset method

 6) For information about the area of use, see the declaration of conformity at: [www.festo.com/catalogue/...](http://www.festo.com/catalogue/...) → Support/Downloads.

If the devices are subject to usage restrictions in residential, commercial or light-industrial environments, further measures for the reduction of the emitted interference may be necessary.

 7) More information: [www.festo.com/x/topic/crc](http://www.festo.com/x/topic/crc)

Datasheet – Sub-base valve M5/M7

Operating and environmental conditions			T32-A <sup>1)</sup>	T32-M <sup>2)</sup>	M32-R <sup>3)</sup>	M52-R <sup>3)</sup>	B52	M52-M <sup>2)</sup>	P53
Valve function			Compressed air to ISO 8573-1:2010 [7:4:4]						
Operating pressure	Internal pilot air supply	[MPa]	0.15 ... 0.8	0.2 ... 0.8	0.15 ... 0.8			0.3 ... 0.8	
		[bar]	1.5 ... 8	2 ... 8	1.5 ... 8			3 ... 8	
	External pilot air supply	[MPa]	0.15 ... 1	-0.09 ... 1			-0.09 ... 0.8		-0.09 ... 1
		[bar]	1.5 ... 10	-0.9 ... 10			-0.9 ... 8		-0.9 ... 10
Pilot pressure <sup>4)</sup>	[MPa]	0.15 ... 0.8	0.2 ... 0.8	0.15 ... 0.8			0.3 ... 0.8		
	[bar]	1.5 ... 8	2 ... 8	1.5 ... 8			3 ... 8		
Ambient temperature		[°C]	-5 ... +60						
Temperature of medium		[°C]	-5 ... +60						
LABS (PWIS) conformity	Valve terminal VTUG-...		VDMA24364-B1/B2-L						
	Valve terminal VTUG-F1A		VDMA24364 zone III						

- 1) Pneumatic spring
- 2) Mechanical spring
- 3) Mixed, pneumatic/mechanical spring
- 4) See graphs on page 11

Electrical data		
Electrical connection		Via E-box
Operating voltage	[V DC]	24 ±10%
Power consumption per valve solenoid	[W]	1/0.4 (after 25 ms)
Duty cycle	[%]	100
Max. switching frequency	[Hz]	3
Protection rating to EN 60529 <sup>1)</sup>	Individual valve	IP65, IP67
	Valve terminal VTUG-F1A	IP40

1) Depending on the configuration selected

Safety characteristics		
Max. positive test pulse with logic 0	[µs]	1600
Max. negative test pulse with logic 1	[µs]	3000
Shock resistance	Shock test with severity level 2 to FN 942017-5 and EN 60068-2-27	
Vibration resistant	Transport application test with severity level 2 to FN 942017-4 and EN 60068-2-6	

## Datasheet – Sub-base valve M5/M7

Information on materials	
Housing	Wrought aluminium alloy
Seals	HNBR, NBR
Note on materials	RoHS-compliant

Valve switching times								
Valve function		T32-A <sup>1)</sup>	T32-M <sup>2)</sup>	M32-R <sup>3)</sup>	M52-R <sup>3)</sup>	B52	M52-M <sup>2)</sup>	P53
Switching time on	[ms]	8	10	9	9	–	12	12
Switching time off	[ms]	20	20	17	21	–	30	38
Switching time changeover	[ms]	–	–	–	–	9	–	16

- 1) Pneumatic spring
- 2) Mechanical spring
- 3) Mixed, pneumatic/mechanical spring

Datasheet – Sub-base valve M5/M7

Dimensions

Download CAD data → [www.festo.com](http://www.festo.com)

Sub-base valve M5/M7

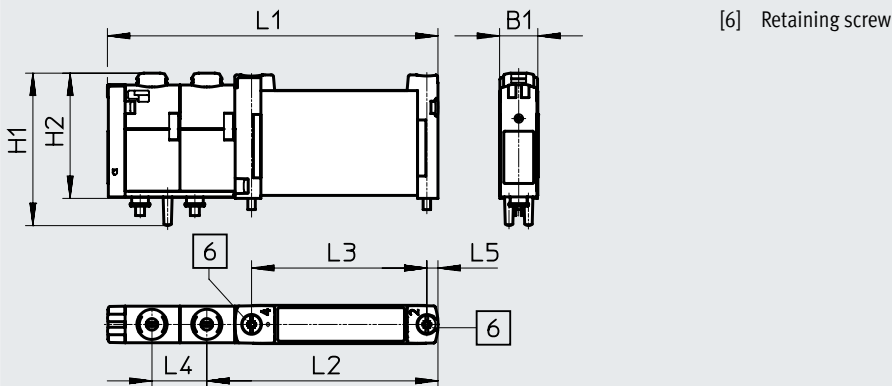

Type	B1	H1	H2	L1	L2	L3	L4	L5
VUVG-B10...-F1T1L-F1A	10.3	40.7	33	88.6	62	47	14.7	3

Ordering data

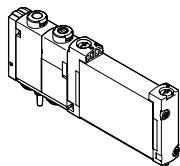
Description	Part no.	Type
<b>Sub-base valve M5/M7</b>		
<b>2x 3/2-way valve</b>		
 External pilot air supply	Normally closed, pneumatic spring return	<b>8150399</b> VUVG-B10-T32C-AZT-F-1T1L-F1A
	Normally open, pneumatic spring return	<b>8141516</b> VUVG-B10-T32U-AZT-F-1T1L-F1A
	1x normally open, 1x normally closed, pneumatic spring return	<b>8141517</b> VUVG-B10-T32H-AZT-F-1T1L-F1A
	Normally closed, mechanical spring return	<b>8141518</b> VUVG-B10-T32C-MZT-F-1T1L-F1A
	Normally open, mechanical spring return	<b>8141519</b> VUVG-B10-T32U-MZT-F-1T1L-F1A
	1x normally open, 1x normally closed, mechanical spring return	<b>8141520</b> VUVG-B10-T32H-MZT-F-1T1L-F1A
<b>5/2-way valve, single solenoid</b>		
External pilot air supply	Mechanical spring return	<b>8150460</b> VUVG-B10-M52-MZT-F-1T1L-F1A
	Pneumatic/mechanical spring return	<b>8150397</b> VUVG-B10-M52-RZT-F-1T1L-F1A
<b>5/2-way valve, double solenoid</b>		
External pilot air supply		<b>8150398</b> VUVG-B10-B52-ZT-F-1T1L-F1A
<b>5/3-way valve</b>		
External pilot air supply	Mid-position closed, mechanical spring return	<b>8141521</b> VUVG-B10-P53C-ZT-F-1T1L-F1A
	Mid-position pressurised, mechanical spring return	<b>8141523</b> VUVG-B10-P53U-ZT-F-1T1L-F1A
	Mid-position exhausted, mechanical spring return	<b>8141522</b> VUVG-B10-P53E-ZT-F-1T1L-F1A

## Datasheet – Sub-base valve G1/8

## Function



3/2C, 3/2U

2x 3/2C, 2x 3/2U, 2x 3/2H

5/2-way, single solenoid

5/2-way, double solenoid

5/3C, 5/3U, 5/3E

-  - Size 14 mm-  - Flow rate  
350 ... 560 l/min-  - Voltage  
24 V DC

Circuit diagrams → page 15

General technical data													
Valve function	T32-A			T32-M			M32-A		M52-A	B52	M52-M	P53	
Normal position	C <sup>1)</sup>	U <sup>2)</sup>	H <sup>4)</sup>	C <sup>1)</sup>	U <sup>2)</sup>	H <sup>4)</sup>	C <sup>1)</sup>	U <sup>2)</sup>	–	–	–	C <sup>1)</sup> U <sup>2)</sup> E <sup>3)</sup>	
Stable position	Monostable									Bistable	Monostable		
Pneumatic spring return	Yes			No			Yes		Yes	–	No	–	
Mechanical spring return	No			Yes			No		No	–	Yes	Yes	
Vacuum operation at port 1	No			With external pilot air									
Design	Piston spool												
Sealing principle	Soft												
Actuation type	Electrical												
Type of control	Piloted												
Pilot air supply	External												
Exhaust air function	Can be throttled												
Manual override	Choice of non-detenting, covered, non-detenting/detenting or detenting												
Type of mounting	On manifold rail												
Overlap	Positive overlap												
Mounting position	Any												
Signal status indication	LED												
Standard nominal flow rate G1/8	[l/min]	530			470			350		550	560	550	510
Flow rate on manifold rail G1/8, front	[l/min]	490			440			320		500	510	500	470
Flow rate on manifold rail G1/8, underneath	[l/min]	530			470			350		550	560	550	510
Size	[mm]	14											
Connection	1, 3, 5, 12/14, 82/84												
	2, 4												
Product weight	[g]	102			100			91		98	89	95	
Certification	c UL us - Recognized (OL)												
	RCM												
CE marking (see declaration of conformity) <sup>5)</sup>	To EU EMC Directive												
Corrosion resistance class CRC <sup>6)</sup>	2												

1) C=Normally closed/mid-position closed

2) U=Normally open/mid-position pressurised

3) E=Mid-position exhausted

4) H=2x 3/2-way valve in one housing with 1x normally closed and 1x normally open

5) For information about the area of use, see the declaration of conformity at: [www.festo.com/catalogue/...](http://www.festo.com/catalogue/...) → Support/Downloads.

If the devices are subject to usage restrictions in residential, commercial or light-industrial environments, further measures for the reduction of the emitted interference may be necessary.

6) More information: [www.festo.com/x/topic/crc](http://www.festo.com/x/topic/crc)

Datasheet – Sub-base valve G1/8

Operating and environmental conditions		T32-A <sup>1)</sup>	T32-M <sup>2)</sup>	M32-A <sup>1)</sup>	M52-A <sup>1)</sup>	B52	M52-M <sup>2)</sup>	P53
Valve function		Compressed air to ISO 8573-1:2010 [7:4:4]						
Operating pressure	Internal pilot air supply	[MPa]	0.15 ... 0.8	0.2 ... 0.8	0.15 ... 0.8		0.3 ... 0.8	
		[bar]	1.5 ... 8	2 ... 8	1.5 ... 8		3 ... 8	
	External pilot air supply	[MPa]	0.15 ... 1	-0.09 ... 1		-0.09 ... 0.8		-0.09 ... 1
		[bar]	1.5 ... 10	-0.9 ... 10		-0.9 ... 8		-0.9 ... 10
Pilot pressure <sup>3)</sup>		[MPa]	0.15 ... 0.8	0.2 ... 0.8	0.15 ... 0.8		0.3 ... 0.8	
		[bar]	1.5 ... 8	2 ... 8	1.5 ... 8		3 ... 8	
Ambient temperature		[°C]	-5 ... +60					
Temperature of medium		[°C]	-5 ... +60					
LABS (PWIS) conformity	Valve terminal VTUG-...	VDMA24364-B1/B2-L						
	Valve terminal VTUG-F1A	VDMA24364 zone III						

- 1) Pneumatic spring
- 2) Mechanical spring
- 3) See graphs on page 11

Electrical data		
Electrical connection	Via E-box	
Operating voltage	[V DC] 24 ±10%	
Power	[W] 1/0.4 (after 25 ms)	
Duty cycle	[%] 100	
Max. switching frequency	[Hz] 3	
Protection rating to EN 60529 <sup>1)</sup>	Individual valve	IP67/IP65
	Valve terminal VTUG-F1A	IP40

1) Depending on the configuration selected

Safety characteristics	
Max. positive test pulse with logic 0	[µs] 1600
Max. negative test pulse with logic 1	[µs] 3000
Shock resistance	Shock test with severity level 2 to FN 942017-5 and EN 60068-2-27
Vibration resistant	Transport application test with severity level 2 to FN 942017-4 and EN 60068-2-6



## Datasheet – Sub-base valve G1/8

Information on materials	
Housing	Wrought aluminium alloy
Seals	HNBR, NBR
Note on materials	RoHS-compliant

Valve switching times								
Valve function		T32-A <sup>1)</sup>	T32-M <sup>2)</sup>	M32-A <sup>1)</sup>	M52-A <sup>1)</sup>	B52	M52-M <sup>2)</sup>	P53
Switching time on	[ms]	10	13	13	13	–	10	15
Switching time off	[ms]	29	21	20	26	–	38	42
Switching time changeover	[ms]	–	–	–	–	9	–	25

1) Pneumatic spring

2) Mechanical spring

Datasheet – Sub-base valve G1/8

Dimensions

Download CAD data → [www.festo.com](http://www.festo.com)

Sub-base valve G1/8

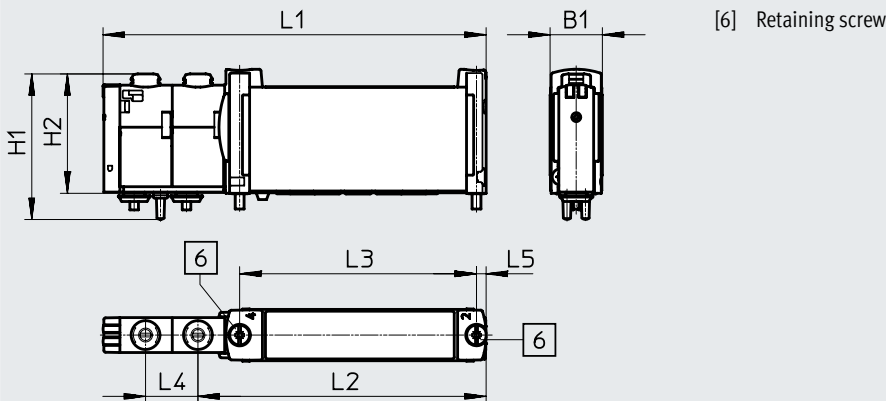

Type	B1	H1	H2	L1	L2	L3	L4	L5
VUVG-B14-...-F-1T1L-F1A	14.7	40.9	33.5	107.6	81	66.5	15.1	2.8

Ordering data

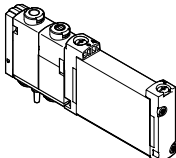
Description	Part no.	Type
<b>Sub-base valve G1/8</b>		
<b>2x 3/2-way valve</b>		
 External pilot air supply	Normally closed, pneumatic spring return	8150402 VUVG-B14-T32C-AZT-F-1T1L-F1A
	Normally open, pneumatic spring return	8141527 VUVG-B14-T32U-AZT-F-1T1L-F1A
	1x normally open, 1x normally closed, pneumatic spring return	8141528 VUVG-B14-T32H-AZT-F-1T1L-F1A
	Normally closed, mechanical spring return	8141529 VUVG-B14-T32C-MZT-F-1T1L-F1A
	Normally open, mechanical spring return	8141530 VUVG-B14-T32U-MZT-F-1T1L-F1A
	1x normally open, 1x normally closed, mechanical spring return	8141531 VUVG-B14-T32H-MZT-F-1T1L-F1A
<b>5/2-way valve, single solenoid</b>		
External pilot air supply	Pneumatic spring return	8150400 VUVG-B14-M52-AZT-F-1T1L-F1A
	Mechanical spring return	8150461 VUVG-B14-M52-MZT-F-1T1L-F1A
<b>5/2-way valve, double solenoid</b>		
External pilot air supply	8150401	VUVG-B14-B52-ZT-F-1T1L-F1A
<b>5/3-way valve</b>		
External pilot air supply	Mid-position closed, mechanical spring return	8141532 VUVG-B14-P53C-ZT-F-1T1L-F1A
	Mid-position pressurised, mechanical spring return	8141534 VUVG-B14-P53U-ZT-F-1T1L-F1A
	Mid-position exhausted, mechanical spring return	8141533 VUVG-B14-P53E-ZT-F-1T1L-F1A

## Datasheet – Manifold rail VABM

General technical data			
Manifold rail	Size 10	Size 14	
Short type code	VABM		
Grid dimension [mm]	10.5	16	
Mounting position	Any		
Connection type	Semi in-line/sub-base		
Max. no. of valve positions	24		
Connection	12/14	M5	M5
	82/84	M5	M5
	2, 4	M5 (VABM-L1-10W-...-GR)	G1/8
		M7 (VABM-L1-10HW-...-GR)	
1, 3, 5	G1/8	–	
Storage temperature [°C]	–20 ... 60		
Certification	c UL us - Recognized (OL)		
CE marking (see declaration of conformity) <sup>1)</sup>	To EU EMC Directive		
Corrosion resistance class CRC <sup>2)</sup>	2		
LABS (PWIS) conformity	VDMA24364-B1/B2-L		

1) For information about the area of use, see the declaration of conformity at: [www.festo.com/catalogue/...](http://www.festo.com/catalogue/...) → Support/Downloads.

If the devices are subject to usage restrictions in residential, commercial or light-industrial environments, further measures for the reduction of the emitted interference may be necessary.

2) More information: [www.festo.com/x/topic/crc](http://www.festo.com/x/topic/crc)

Weight [g]											
Valve positions	4	5	6	7	8	9	10	12	16	20	24
VABM-L1-10G-G18-...	329	363	397	431	465	499	533	601	737	873	1009
VABM-L1-10HW-G18-...	388	426	464	502	540	578	616	692	844	996	1148
VABM-L1-14G-G14-...	879	990	1101	1212	1323	1434	1545	1767	2211	2655	3099
VABM-L1-14W-G14-...	839	940	1041	1142	1243	1344	1445	1647	2051	2455	2859
VABM-L1-18G-G38-...	1461	1661	1861	2061	2261	2461	2661	3061	3861	4661	5461
VABM-L1-18W-G38-...	1369	1546	1723	1900	2077	2254	2431	2785	3493	4201	4909

Materials	
Manifold rail	Wrought aluminium alloy
Note on materials	RoHS-compliant

Datasheet – Manifold rail VABM

Dimensions – Example of valve terminal with I-Port interface

Download CAD data → [www.festo.com](http://www.festo.com)

Outlet orientation of electrical components on top

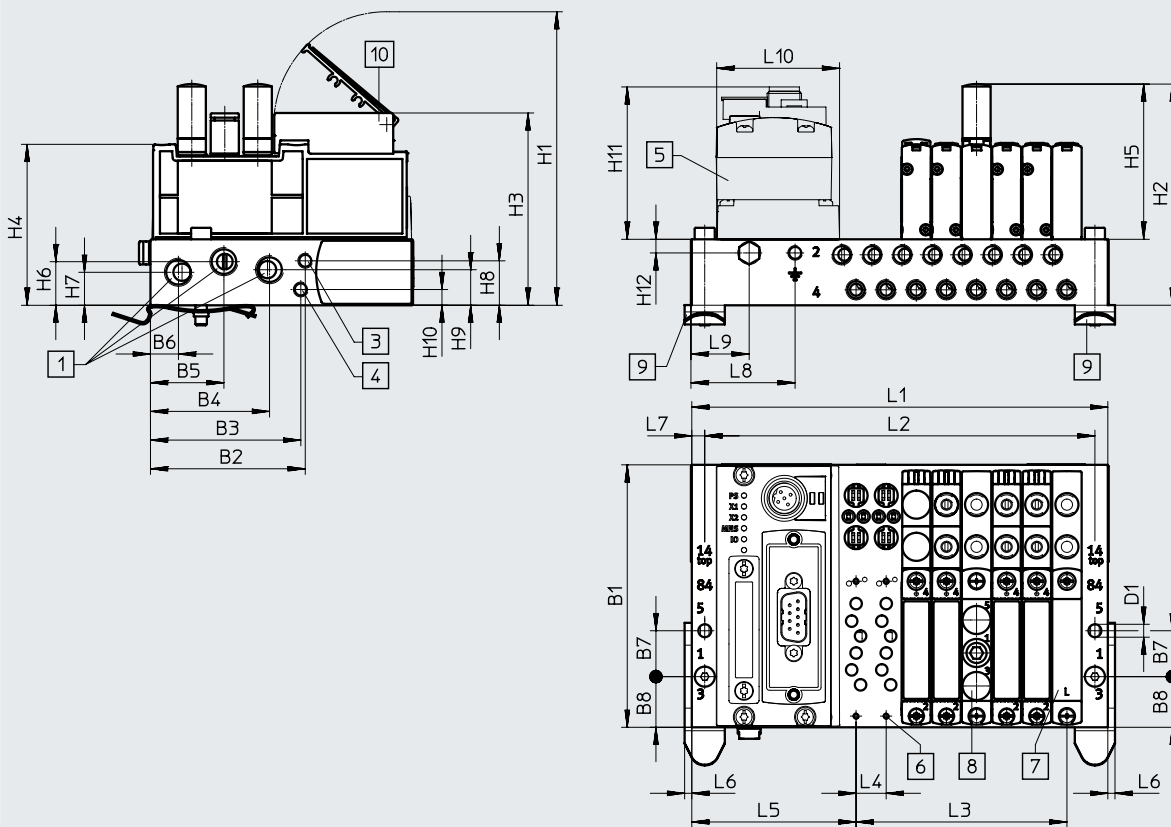

- [1] Ports 1, 3 and 5: size 10: G1/8 (at both ends)
- [2] Port 12/14: size 10 and 14: M5 (at both ends)
- [3] Port 82/84: size 10 and 14: M5 (at both ends)
- [4] CTEU-CANopen
- [5] Valves/cover plates/supply plates – mounting on manifold block: size 10: M2, size 14: M2.5
- [6] Cover plate
- [7] Supply plate, ports 1, 3 and 5: size 10: M7, size 14: G1/8
- [8] H-rail mounting
- [9] Inscription label holder
- [10]

Type	Number of valve positions	Size 10																
		B1	B2	B3	B4	B5	B6	B7	B8	D1 ø	H1	H2	H3	H4	H5	H6	H7	H8
VABM	4-24	91.5	54	52.4	41.5	25.6	9.8	16	17.7	4.5	102.3	77.1	67	56.1	54.1	15.2	11.5	15.5

Type	Number of valve positions	Size 10										
		H9	H10	H11	H12	L4	L5	L6	L7	L8	L9	L10
VABM	4-24	12.4	5.5	54.8	4.8	10.5	57.3	2.5	4.5	36	20	42.5

Type	Number of valve positions	Size 14																
		B1	B2	B3	B4	B5	B6	B7	B8	D1 ø	H1	H2	H3	H4	H5	H6	H7	H8
VABM	4-24	110	70	59.3	56.5	36.5	16	20	26.5	4.5	113.1	95.1	77.7	68.6	61.3	18.7	15.7	28.7

## Datasheet – Manifold rail VABM

Type	Number of valve positions	Size 14										
		H9	H10	H11	H12	L4	L5	L6	L7	L8	L9	L10
VABM	4-24	13.2	23.7	54.8	5.1	16	60.6	2	5	10	25.5	42.5

Type	Number of valve positions	Size 10			Size 14		
		L1	L2	L3	L1	L2	L3
VABM	4	103	94	31.5	128	118	48
	5	113.5	104.5	42	144	134	64
	6	124	115	52.5	160	150	80
	7	134.5	125.5	63	176	166	96
	8	145	136	73.5	192	182	112
	9	155.5	146.5	84	208	198	128
	10	166	157	94.5	224	214	144
	12	187	178	115.5	256	246	176
	16	229	220	157.5	320	310	240
	20	271	262	199.5	384	374	304
24	313	304	241.5	448	438	368	

Datasheet – Manifold rail VABM

Number of valve positions	L1	L2	L3
VABM-L1-10HWS1-G18-4-GR	116.2	84	31.5
VABM-L1-10HWS1-G18-8-GR	158.2	126	73.5
VABM-L1-10HWS2-G18-8-GR	184	168	73.5
VABM-L1-10HWS2-G18-12-GR	226	210	115.5
VABM-L1-10HWS2-G18-16-GR	268	252	157.5
VABM-L1-10HWS2-G18-24-GR	352	336	241.5
VABM-L1-10HWS2-H-G18-8-GR	184	168	73.5
VABM-L1-10HWS2-H-G18-12-GR	226	210	115.5
VABM-L1-10HWS2-H-G18-16-GR	268	252	157.5
VABM-L1-10HWS2-H-G18-24-GR	352	336	241.5
VABM-L1-14HWS1-G14-4-GR	135	64	48
VABM-L1-14HWS1-G14-8-GR	199	128	112
VABM-L1-14HWS2-G14-8-GR	234	192	112
VABM-L1-14HWS2-G14-12-GR	298	256	176
VABM-L1-14HWS2-G14-16-GR	362	320	240
VABM-L1-14HWS2-G14-24-GR	490	448	368
VABM-L1-14HWS2-H-G14-8-GR	234	192	112
VABM-L1-14HWS2-H-G14-12-GR	298	256	176
VABM-L1-14HWS2-H-G14-16-GR	362	320	240
VABM-L1-14HWS2-H-G14-24-GR	490	448	368

Datasheet – Manifold rail VABM

Dimensions – Manifold rail outlet orientation at the front

Download CAD data → [www.festo.com](http://www.festo.com)

Size 10, I-Port interface on top

Size 14, I-Port interface on top

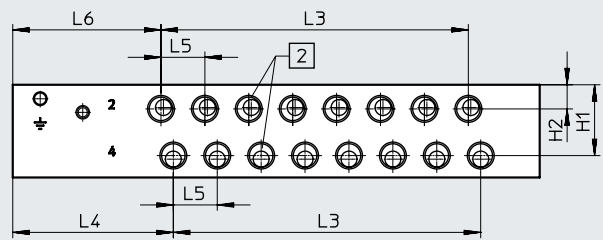
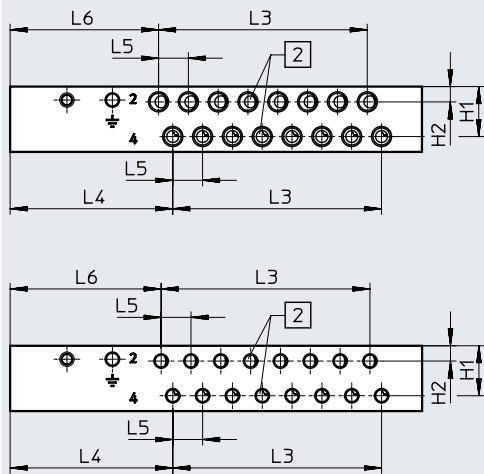

[2] Port 2 and 4

[2] Port 2 and 4

Size	Port 2 and 4	Manifold rail with I-Port interface on top				
		H1	H2	L4	L5	L6
10	M7 thread	17.6	5.4	57.3	10.5	52.3
	M5 thread					53.2
14	G1/8 thread	25.8	8.8	58.5	16	54

Datasheet – Manifold rail VABM

Type	Number of valve positions	Size 10	Size 14
		L3	L3
VABM	4	31.5	48
	5	42	64
	6	52.5	80
	7	63	96
	8	73.5	112
	9	84	128
	10	94.5	144
	12	115.5	176
	16	157.5	240
	20	199.5	304
	24	241.5	368



## Datasheet – Manifold rail VABM

Type	Manifold rail with I-Port interface, size 10										
	B1	B2	B3	B4	B5	L4	L5	L6	L7	L8	L9
VABM	41	31.8	27	20	13	108.3	10.5	105.2	91.8	81.8	4.5

Type	Manifold rail with I-Port interface, size 14										
	B1	B2	B3	B4	B5	L4	L5	L6	L7	L8	L9
VABM	53.5	45.1	35.2	27.8	17	108	16	108	92.5	82.5	5

Type	Number of valve positions	Manifold rail with I-Port interface Size 10			Manifold rail with I-Port interface Size 14		
		L1 +5	L2 +5	L3	L1	L2	L3
		VABM	4	152.5	143.5	31.5	177.5
	5	163	154	42	193.5	183.5	64
	6	173.5	164.5	52.5	209.5	199.5	80
	7	184	175	63	225.5	215.5	96
	8	194.5	185.5	73.5	241.5	231.5	112
	9	205	196	84	257.5	247.5	128
	10	215.5	206.5	94.5	273.5	263.5	144
	12	236.5	227.5	115.5	305.5	295.5	176
	16	278.5	269.5	157.5	369.5	359.5	240
	20	320.5	311.5	199.5	433.5	423.5	304
	24	362.5	353.5	241.5	497.5	487.5	368

## Ordering data

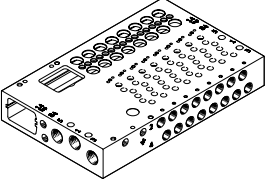
Ordering data	Description	Part no.	Type	
<b>Manifold rail for sub-base valve</b>				
	<b>Size 10 mm</b>			
	Ports 2, 4 at the front	4 valve positions	573434	VABM-L1-10HW-G18-4-GR
		5 valve positions	573435	VABM-L1-10HW-G18-5-GR
		6 valve positions	573436	VABM-L1-10HW-G18-6-GR
		7 valve positions	573437	VABM-L1-10HW-G18-7-GR
		8 valve positions	573438	VABM-L1-10HW-G18-8-GR
		9 valve positions	573439	VABM-L1-10HW-G18-9-GR
		10 valve positions	573440	VABM-L1-10HW-G18-10-GR
		12 valve positions	573441	VABM-L1-10HW-G18-12-GR
		16 valve positions	573442	VABM-L1-10HW-G18-16-GR
		20 valve positions	573443	VABM-L1-10HW-G18-20-GR
		24 valve positions	573444	VABM-L1-10HW-G18-24-GR
		8 double solenoid + 8 single solenoid valves	573930	VABM-L1-10HW-G18-16-M-GR
		4 double solenoid + 16 single solenoid valves	573931	VABM-L1-10HW-G18-20-M-GR
		24 single solenoid valves	573932	VABM-L1-10HW-G18-24-M-GR
	<b>Size 14 mm</b>			
	Ports 2, 4 at the front	4 valve positions	573500	VABM-L1-14W-G14-4-GR
		5 valve positions	573501	VABM-L1-14W-G14-5-GR
		6 valve positions	573502	VABM-L1-14W-G14-6-GR
		7 valve positions	573503	VABM-L1-14W-G14-7-GR
		8 valve positions	573504	VABM-L1-14W-G14-8-GR
		9 valve positions	573505	VABM-L1-14W-G14-9-GR
		10 valve positions	573506	VABM-L1-14W-G14-10-GR
		12 valve positions	573507	VABM-L1-14W-G14-12-GR
		16 valve positions	573508	VABM-L1-14W-G14-16-GR
		20 valve positions	573509	VABM-L1-14W-G14-20-GR
		24 valve positions	573510	VABM-L1-14W-G14-24-GR
		8 double solenoid + 8 single solenoid valves	573936	VABM-L1-14W-G14-16-M-GR
4 double solenoid + 16 single solenoid valves		573937	VABM-L1-14W-G14-20-M-GR	
24 single solenoid valves		573938	VABM-L1-14W-G14-24-M-GR	

## Datasheet – Multi-pin plug connection

The following multi-pin plug connections are available for the valve terminal VTUG:

- Sub-D (25-pin)
- Sub-D (44-pin)
- Ribbon cable (26-pin)
- Ribbon cable (50-pin)



### Electrical multi-pin

Each pin on the multi-pin plug can actuate exactly one solenoid coil.

If the maximum configurable number of valve positions is 24, this means that 48 valve functions can be addressed.

The valves can be switched using positive or negative logic (positive switching or negative switching).

Mixed operation is generally not possible; however, an exception is made for the V22 ... V25 variants with 25-pin Sub-D. With these variants, a specific range of valve positions (e.g. Com 16...19) is supplied with common voltage.

This allows these ranges to be switched with positive or negative logic and valve groups to be switched off independently of the other ranges. Mixed operation within a range is not permitted.

#### - Note

A double solenoid valve occupies one valve position and two pins on the multi-pin plug. This means that the number of double solenoid valves per manifold rail is limited. (Pin allocation → page 36)

General technical data				
Type	VAEM-L1-S-M1-25	VAEM-L1-S-M1-44	VAEM-L1-S-M3-26	VAEM-L1-S-M3-50
Number of pins	25-pin	44-pin	26-pin	50-pin
Electrical connection	Sub-D plug		Ribbon cable plug	
Max. no. of valve positions	24		24	
Protection rating to EN 60529	IP67		IP40	
Material	PA		PA	
Note on materials	RoHS-compliant		RoHS-compliant	
Certification	c UL us - Recognized (OL)			
CE marking (see declaration of conformity) <sup>1)</sup>	To EU EMC Directive			
Corrosion resistance class CRC <sup>2)</sup>	2			
LABS (PWIS) conformity	VDMA24 364-B1/B2-L			
Weight [g]	53		45	48

1) For information about the area of use, see the EC declaration of conformity at: [www.festo.com/catalogue/...](http://www.festo.com/catalogue/...) → Support/Downloads.

If the devices are subject to usage restrictions in residential, commercial or light-industrial environments, further measures for the reduction of the emitted interference may be necessary.

2) More information: [www.festo.com/x/topic/crc](http://www.festo.com/x/topic/crc)

Datasheet – Multi-pin plug connection

Pin allocation – Sub-D plug, 25-pin												
	Pin	Wire colour <sup>1)</sup>	M1-25 (V20)								M1-25V1 (V22)	
			12x double solenoid		8x double solenoid 8x single solenoid		4x double solenoid 16x single solenoid		24x single solenoid			
	1	WH	VP0	14	VP0	14	VP0	14	VP0	14	VP0	14
	2	BN	VP0	12	VP0	12	VP0	12	VP23	14	VP0	12
	3	GN	VP1	14	VP1	14	VP1	14	VP1	14	VP1	14
	4	YE	VP1	12	VP1	12	VP1	12	VP22	14	VP1	12
	5	GY	VP2	14	VP2	14	VP2	14	VP2	14	VP2	14
	6	PK	VP2	12	VP2	12	VP2	12	VP21	14	VP2	12
	7	BU	VP3	14	VP3	14	VP3	14	VP3	14	VP3	14
	8	RD	VP3	12	VP3	12	VP3	12	VP20	14	VP3	12
	9	BK	VP4	14	VP4	14	VP4	14	VP4	14	VP4	14
	10	VT	VP4	12	VP4	12	VP19	14	VP19	14	VP4	12
	11	GY PK	VP5	14	VP5	14	VP5	14	VP5	14	VP5	14
	12	RD BU	VP5	12	VP5	12	VP18	14	VP18	14	VP5	12
	13	GN WH	VP6	14	VP6	14	VP6	14	VP6	14	VP6	14
	14	BN GN	VP6	12	VP6	12	VP17	14	VP17	14	VP6	12
	15	YE WH	VP7	14	VP7	14	VP7	14	VP7	14	VP7	14
	16	BN YE	VP7	12	VP7	12	VP16	14	VP16	14	VP7	12
	17	GY WH	VP8	14	VP8	14	VP8	14	VP8	14	VP8	14
	18	BN GY	VP8	12	VP15	14	VP15	14	VP15	14	VP8	12
	19	WH PK	VP9	14	VP9	14	VP9	14	VP9	14	VP9	14
	20	BN PK	VP9	12	VP14	14	VP14	14	VP14	14	VP9	12
	21	BU WH	VP10	14	VP10	14	VP10	14	VP10	14	Com 16...19	
	22	BN BU	VP10	12	VP13	14	VP13	14	VP13	14	Com 12...15	
	23	RD WH	VP11	14	VP11	14	VP11	14	VP11	14	Com 8...11	
	24	BN RD	VP11	12	VP12	14	VP12	14	VP12	14	Com 4...7	
	25	BK WH	Com		Com		Com	Com	Com		Com 0...3	

1) According to IEC 60757  
VP Valve position

 **Note**  
A grey field means that a double solenoid valve can be used. Only single solenoid valves can be used for fields with a white background.

Datasheet – Multi-pin plug connection

Pin allocation – Sub-D plug, 25-pin						Pin allocation – Sub-D plug, 44-pin					
Pin	Wire colour <sup>1)</sup>	M1-25V2 (V23)	M1-25V3 (V24)	M1-25V4 (V25)		Pin	Wire colour <sup>1)</sup>	M1-44 (V21)			
								18x double solenoid, 6x single solenoid			
1	WH	VP0	14	VP0	14	VP0	14	1	WH	VP0	14
2	BN	VP0	12	VP0	12	VP1	14	2	BN	VP0	12
3	GN	VP1	14	VP1	14	VP2	14	3	GN	VP1	14
4	YE	VP1	12	VP1	12	VP3	14	4	YE	VP1	12
5	GY	VP2	14	VP2	14	VP4	14	5	GY	VP2	14
6	PK	VP2	12	VP2	12	VP5	14	6	PK	VP2	12
7	BU	VP3	14	VP3	14	VP6	14	7	BU	VP3	14
8	RD	VP3	12	VP3	12	VP7	14	8	RD	VP3	12
9	BK	VP4	14	VP4	14	VP8	14	9	BK	VP4	14
10	VT	VP4	12	VP5	14	VP9	14	10	VT	VP4	12
11	GY PK	VP5	14	VP6	14	VP10	14	11	GY PK	VP5	14
12	RD BU	VP5	12	VP7	14	VP11	14	12	RD BU	VP5	12
13	GN WH	VP6	14	VP8	14	VP12	14	13	GN WH	VP6	14
14	BN GN	VP6	12	VP9	14	VP13	14	14	BN GN	VP6	12
15	YE WH	VP7	14	VP10	14	VP14	14	15	YE WH	VP7	14
16	BN YE	VP7	12	VP11	14	VP15	14	16	BN YE	VP7	12
17	GY WH	VP8	14	VP12	14	VP16	14	17	GY WH	VP8	14
18	BN GY	VP9	14	VP13	14	VP17	14	18	BN GY	VP8	12
19	WH PK	VP10	14	VP14	14	VP18	14	19	WH PK	VP9	14
20	BN PK	VP11	14	VP15	14	VP19	14	20	BN PK	VP9	12
21	BU WH	Com 16...19		Com 16...19		Com 16...19		21	BU WH	VP10	14
22	BN BU	Com 12...15		Com 12...15		Com 12...15		22	BN BU	VP10	12
23	RD WH	Com 8...11		Com 8...11		Com 8...11		23	RD WH	VP11	14
24	BN RD	Com 4...7		Com 4...7		Com 4...7		24	BN RD	VP11	12
25	BK WH	Com 0...3		Com 0...3		Com 0...3		25	BK WH	VP12	14
–								26	BK BN	VP12	12
–								27	GN GY	VP13	14
–								28	YE GY	VP13	12
–								29	GN PK	VP14	14
–								30	YE PK	VP14	12
–								31	GN BU	VP15	14
–								32	YE BU	VP15	12
–								33	RD GN	VP16	14
–								34	RD YE	VP16	12
–								35	BK GN	VP17	14
–								36	BK YE	VP17	12
–								37	BU GY	VP18	14
–								38	BU PK	VP19	14
–								39	RD GY	VP20	14
–								40	RD PK	VP21	14
–								41	BK GY	VP22	14
–								42	BK PK	VP23	14
–								43	BK BU	com	
–								44	BK RD		

1) According to IEC 60757  
VP Valve position

 **Note**  
A grey field means that a double solenoid valve can be used. Only single solenoid valves can be used for fields with a white background.

Datasheet – Multi-pin plug connection

Pin allocation – Ribbon cable, 26-pin										Pin allocation – Ribbon cable, 50-pin			
Pin	M3-26 (V20)								Pin	M3-50 (V26)			
	12x double solenoid		8x double solenoid 8x single solenoid		4x double solenoid 16x single solenoid		24x single solenoid			Pin	M3-50 (V26)		
1	VP0	14	VP0	14	VP0	14	VP0	14	1	VP0	14		
2	VP0	12	VP0	12	VP0	12	VP23	14	2	VP0	12		
3	VP1	14	VP1	14	VP1	14	VP1	14	3	VP1	14		
4	VP1	12	VP1	12	VP1	12	VP22	14	4	VP1	12		
5	VP2	14	VP2	14	VP2	14	VP2	14	5	VP2	14		
6	VP2	12	VP2	12	VP2	12	VP21	14	6	VP2	12		
7	VP3	14	VP3	14	VP3	14	VP3	14	7	VP3	14		
8	VP3	12	VP3	12	VP3	12	VP20	14	8	VP3	12		
9	VP4	14	VP4	14	VP4	14	VP4	14	9	VP4	14		
10	VP4	12	VP4	12	VP19	14	VP19	14	10	VP4	12		
11	VP5	14	VP5	14	VP5	14	VP5	14	11	VP5	14		
12	VP5	12	VP5	12	VP18	14	VP18	14	12	VP5	12		
13	VP6	14	VP6	14	VP6	14	VP6	14	13	VP6	14		
14	VP6	12	VP6	12	VP17	14	VP17	14	14	VP6	12		
15	VP7	14	VP7	14	VP7	14	VP7	14	15	VP7	14		
16	VP7	12	VP7	12	VP16	14	VP16	14	16	VP7	12		
17	VP8	14	VP8	14	VP8	14	VP8	14	17	VP8	14		
18	VP8	12	VP15	14	VP15	14	VP15	14	18	VP8	12		
19	VP9	14	VP9	14	VP9	14	VP9	14	19	VP9	14		
20	VP9	12	VP14	14	VP14	14	VP14	14	20	VP9	12		
21	VP10	14	VP10	14	VP10	14	VP10	14	21	VP10	14		
22	VP10	12	VP13	14	VP13	14	VP13	14	22	VP10	12		
23	VP11	14	VP11	14	VP11	14	VP11	14	23	VP11	14		
24	VP11	12	VP12	14	VP12	14	VP12	14	24	VP11	12		
25	Com		Com		Com	Com	Com		25	VP12	14		
26	Com		Com		Com		Com		26	VP12	12		
-									27	VP13	14		
-									28	VP13	12		
-									29	VP14	14		
-									30	VP14	12		
-									31	VP15	14		
-									32	VP15	12		
-									33	VP16	14		
-									34	VP16	12		
-									35	VP17	14		
-									36	VP17	12		
-									37	VP18	14		
-									38	VP18	12		
-									39	VP19	14		
-									40	VP19	12		
-									41	VP20	14		
-									42	VP20	12		
-									43	VP21	14		
-									44	VP21	12		
-									45	VP22	14		
-									46	VP22	12		
-									47	VP23	14		
-									48	VP23	12		
-									49	Com			
-									50				

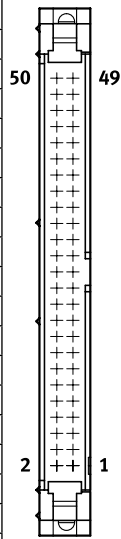
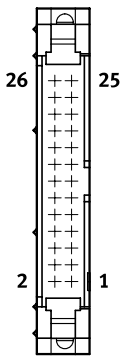

**Note**  
 A grey field means that a double solenoid valve can be used.  
 Only single solenoid valves can be used for fields with a white background.

VP Valve position

## Datasheet – Multi-pin plug connection

### Dimensions

Download CAD data → [www.festo.com](http://www.festo.com)

Multi-pin plug connection, Sub-D

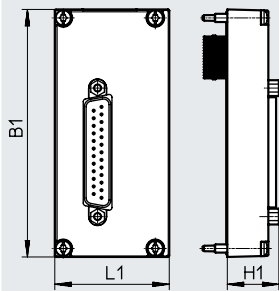

-  - **Note**

Dimensions of the manifold rail with electrical connection  
(→ Page 28)

Type	B1	L1	H1
VAEM-L1-S-M1-...	90.5	41.9	18.9

### Dimensions

Download CAD data → [www.festo.com](http://www.festo.com)

Multi-pin plug connection, ribbon cable

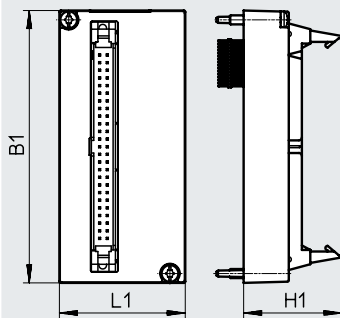

-  - **Note**

Dimensions of the manifold rail with electrical connection  
(→ Page 28)

Type	B1	L1	H1
VAEM-L1-S-M3-...	90.5	41.9	32.7

## Accessories – Multi-pin plug connection

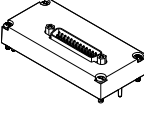
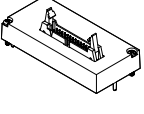
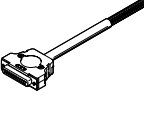
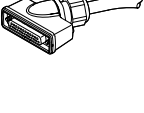
Ordering data		Description	Part no.	Type	
<b>Electrical interface, Sub-D</b>					
	25-pin	For variant M1-25 (V20)	573445	VAEM-L1-S-M1-25	
		For variant M1-25V1 (V22)	573447	VAEM-L1-S-M1-25V1	
		For variant M1-25V2 (V23)	573448	VAEM-L1-S-M1-25V2	
		For variant M1-25V3 (V24)	573449	VAEM-L1-S-M1-25V3	
		For variant M1-25V4 (V25)	573450	VAEM-L1-S-M1-25V4	
44-pin	For variant M1-44 (V21)	573446	VAEM-L1-S-M1-44		
<b>Electrical interface, ribbon cable plug</b>					
	26-pin	For variant M3-26 (V20)	573452	VAEM-L1-S-M3-26	
	50-pin	For variant M3-50 (V26)	573451	VAEM-L1-S-M3-50	
<b>Connecting cable for multi-pin plug</b>					
	Sub-D socket, straight	<ul style="list-style-type: none"> <li>• 25-pin, up to 24 coils, IP40</li> <li>• Open cable end, 25-core</li> </ul>	2.5 m	575417	NEBV-S1G25-K-2.5-N-LE25-S6
			5 m	575418	NEBV-S1G25-K-5-N-LE25-S6
			10 m	575419	NEBV-S1G25-K-10-N-LE25-S6
		<ul style="list-style-type: none"> <li>• 44-pin, up to 42 coils, IP40</li> <li>• Open cable end, 44-core</li> </ul>	2.5 m	575113	NEBV-S1G44-K-2.5-N-LE44-S6
			5 m	575114	NEBV-S1G44-K-5-N-LE44-S6
			10 m	575115	NEBV-S1G44-K-10-N-LE44-S6
	Sub-D socket, angled	<ul style="list-style-type: none"> <li>• 25-pin, up to 24 coils, IP65</li> <li>• Open cable end, 25-core</li> </ul>	2.5 m	575423	NEBV-S1WA25-K-2.5-N-LE25-S9
			5 m	575424	NEBV-S1WA25-K-5-N-LE25-S9
			10 m	575425	NEBV-S1WA25-K-10-N-LE25-S9
		<ul style="list-style-type: none"> <li>• 44-pin, up to 42 coils, IP65</li> <li>• Open cable end, 44-core</li> </ul>	2.5 m	575420	NEBV-S1WA44-K-2.5-N-LE44-S9
			5 m	575421	NEBV-S1WA44-K-5-N-LE44-S9
			10 m	575422	NEBV-S1WA44-K-10-N-LE44-S9



## Datasheet – I-Port interface/IO-Link®

Festo-specific, standardised interface for direct connection to the fieldbus by mounting the bus node CTEU or to an IO-Link master via a cable (in IO-Link mode).

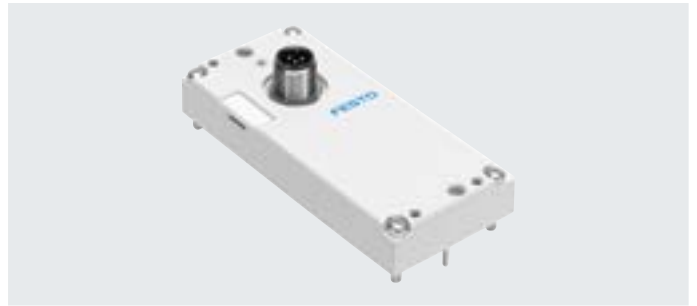

### I-Port interface/IO-Link®

Versions:

- I-Port interface for bus nodes (CTEU)
- IO-Link® mode for direct connection to a higher-level IO-Link master

The following protocols are supported in connection with the associated

CTEU bus node:

- CANopen
- DeviceNet
- PROFIBUS
- CC-LINK
- EtherCAT
- AS-Interface
- PROFINET
- EtherNet/IP
- VARAN
- Festo installation system CPI

The electrical supply/transmission of communication takes place via an M12 plug.

The valve terminal can be equipped with 4 ... 24 (double solenoid) valves.

### General technical data

Types of communication	IO-Link®		
Electrical connection	<ul style="list-style-type: none"> <li>• M12 plug, 5-pin</li> <li>• A-coded</li> <li>• Metal thread for shielding</li> </ul>		
Baud rates	COM3	[kbps]	230.4
	COM2	[kbps]	38.4
Intrinsic current consumption, logic supply PS		[mA]	30
Intrinsic current consumption, valve supply PL		[mA]	30
Max. number of solenoid coils	VAEM-L1-S-8-PT		16
	VAEM-L1-S-16-PT		32
	VAEM-L1-S-24-PT		48
Max. no. of valve positions	VAEM-L1-S-8-PT		8
	VAEM-L1-S-16-PT		16
	VAEM-L1-S-24-PT		24
Ambient temperature		[°C]	-5 ... +50
Product weight	Outlet on top	[g]	49
	Outlet on the side	[g]	100
Protection rating to EN 60529	IP67		
Certification	c UL us - Recognized (OL)		
CE marking (see declaration of conformity) <sup>1)</sup>	To EU EMC Directive		
Corrosion resistance class CRC <sup>2)</sup>	2		
LABS (PWIS) conformity	VDMA24364-B1/B2-L		

1) For information about the area of use, see the EC declaration of conformity at: [www.festo.com/catalogue/...](http://www.festo.com/catalogue/...) → Support/Downloads.

If the devices are subject to usage restrictions in residential, commercial or light-industrial environments, further measures for the reduction of the emitted interference may be necessary.

2) More information: [www.festo.com/x/topic/crc](http://www.festo.com/x/topic/crc)

## Datasheet – I-Port interface/IO-Link®

Status LED X1	Meaning (up to Rev. 07)	Meaning (from Rev. 08)
Illuminated green	Normal operating status	Data communication faulty
Flashes green	Data communication faulty	Normal operating status
Flashes alternately between red/green	24 V load voltage supply faulty	-
Flashes red	Device error	
Illuminated red	24 V load voltage supply and data communication faulty	24 V load voltage supply faulty. Data communication may be faulty
Off	No 24 V operating voltage supply or undervoltage	

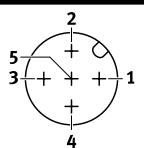
Pin allocation – I-Port interface/IO-Link®			
	Pin	Allocation	Description
	1	24V <sub>EL/SEN</sub>	Operating voltage supply (electronics, sensors/inputs)
	2	24V <sub>VAL/OUT</sub>	Load voltage supply (valves/outputs)
	3	0V <sub>EL/SEN</sub>	Operating voltage supply (electronics, sensors/inputs)
	4	C/Q	Data communication
	5	0V <sub>VAL/OUT</sub>	Load voltage supply (valves/outputs)

### System overview – IO-Link®

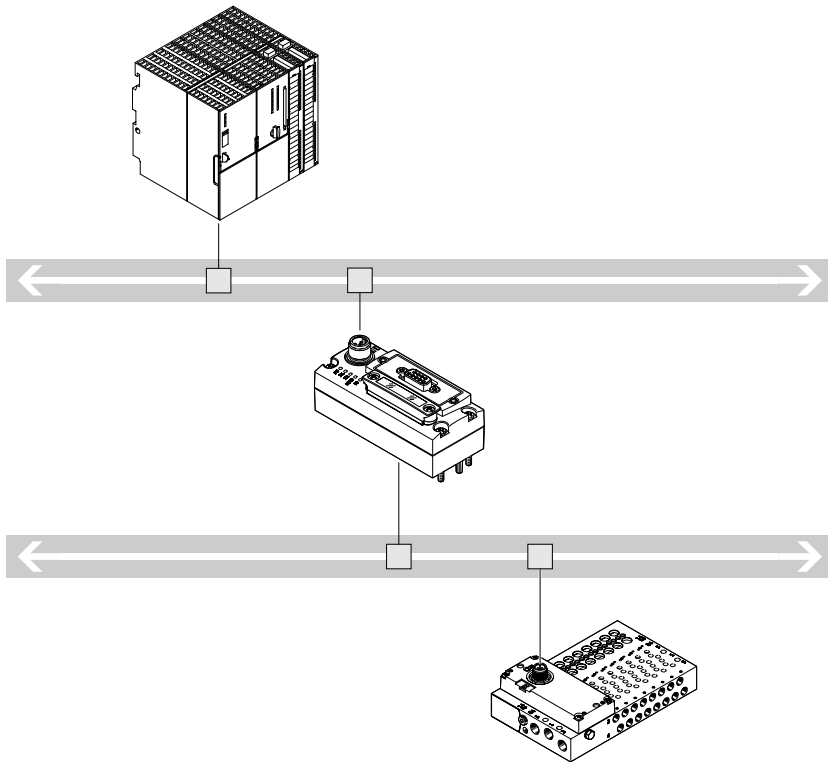

- Communication with the higher-order controller via fieldbus
- Use a bus node CTEU compatible with the fieldbus protocol
- Up to 64 inputs/outputs (solenoid coils), depending on the valve terminal
- No preprocessing

Datasheet – I-Port interface/IO-Link®

Dimensions

Download CAD data → [www.festo.com](http://www.festo.com)

I-Port interface, outlet on top

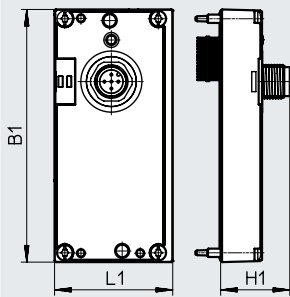

-  - **Note**

Dimensions of the manifold rail with electrical connection → page 28

I-Port interface, outlet on side

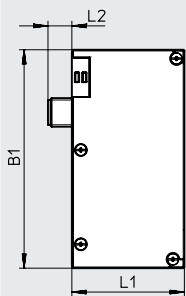





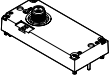

-  - **Note**

Dimensions of the manifold rail with electrical connection → page 28

Type	Outlet on top			Outlet on the side		
	B1	L1	H1	B1	L1	L2
VAEM-L1-S-...	91	42.5	25	91.5	47.1	10

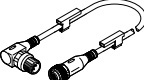
Datasheet – I-Port interface/IO-Link®

Ordering data		Description	Part no.	Type	
<b>Electrical interface for I-Port interface/IO-Link®, outlet on top</b>					
	Actuation of up to 8 double solenoid valve positions		573384	VAEM-L1-S-8-PT	
	Actuation of up to 16 double solenoid valve positions		573939	VAEM-L1-S-16-PT	
	Actuation of up to 24 double solenoid valve positions		573940	VAEM-L1-S-24-PT	
<b>Connection technology for IO-Link®</b>					
	T-adapter M12, 5-pin for IO-Link® and load supply		171175	FB-TA-M12-5POL	
	Straight plug, M12, 5-pin, for T adapter FB-TA		175487	SEA-M12-5GS-PG7	
	Y-distributor with cable on controller side, M12x1 A-coded, for IO-Link®		Cable length 1 m	8091516	NEBU-L1R2-M12G5-M12LE-1R
	M12x1 A-coded, for IO-Link®, straight cable outlet		Cable length 0.5 m	8000208	NEBU-M12G5-K-0.5-M12G4
	M12x1 A-coded, for IO-Link®, straight cable outlet		Cable length 5 m	574321	NEBU-M12G5-E-5-Q8N-M12G5
	M12x1 A-coded, for IO-Link®, straight cable outlet		Cable length 7.5 m	574322	NEBU-M12G5-E-7.5-Q8N-M12G5
	M12x1 A-coded, for IO-Link®, straight cable outlet		Cable length 0.5 m	8003617	NEBU-M12G5-K-0.5-M12W5
	M12x1 A-coded, for IO-Link®, straight cable outlet		Cable length 2 m	8003618	NEBU-M12G5-K-2-M12W5
	M12x1 A-coded, for IO-Link®, angled cable outlet		Cable length 0.5 m	570733	NEBU-M12W5-K-0.5-M12W5
	M12x1 A-coded, for IO-Link®, angled cable outlet		Cable length 2 m	570734	NEBU-M12W5-K-2-M12W5
<b>Inscription label for I-Port interface/IO-Link®</b>					
	40 pieces in frame		565306	ASLR-C-E4	

## Datasheet – CAPC

### Function

The electrical connection block CAPC enables the decentralised installation of bus nodes CTEU on a valve terminal or input modules with I-Port interface.

### Area of application

- M12 connection technology (two interfaces)
- Enables the installation of valve terminals or other devices over a distance of 20 metres
- Accessory CAFM enables the connection block to be installed on an H-rail



### General technical data

Type	CAPC-F1-E-M12	
Dimensions W x L x H	[mm]	50 x 148 x 28
Fieldbus interface		2x M12 socket, 5-pin
Operating voltage range	[V DC]	18 ... 30
Max. power supply	[A]	2
Nominal operating voltage	[V DC]	24
Product weight	[g]	85
Cable length	[m]	20

### Materials

Housing	Reinforced PA
Note on materials	RoHS-compliant

### Operating and environmental conditions

Protection rating to EN 60529	IP65, IP67
Ambient temperature	[°C] -5 ... +50
Storage temperature	[°C] -20 ... +70
Corrosion resistance class CRC <sup>1)</sup>	2
CE marking (see declaration of conformity) <sup>2)</sup>	To EU EMC Directive
LABS (PWIS) conformity	VDMA24364-B2-L

1) More information: [www.festo.com/x/topic/crc](http://www.festo.com/x/topic/crc)

2) For information about the area of use, see the EC declaration of conformity at: [www.festo.com/catalogue/...](http://www.festo.com/catalogue/...) → Support/Downloads.

If the devices are subject to usage restrictions in residential, commercial or light-industrial environments, further measures for the reduction of the emitted interference may be necessary.

### Pin allocation – Power supply/IO-Link® interfaces

	Pin	Allocation	Description
	1	24V <sub>EL/SEN</sub>	Operating voltage supply (electronics, sensors/inputs)
	2	24V <sub>VAL/OUT</sub>	Load voltage supply (valves/outputs)
	3	0V <sub>EL/SEN</sub>	Operating voltage supply (electronics, sensors/inputs)
	4	C/Q	Data communication
	5	0V <sub>VAL/OUT</sub>	Load voltage supply (valves/outputs)
		Housing, FE	Functional earth

Datasheet – CAPC

Dimensions

Download CAD data → [www.festo.com](http://www.festo.com)

CAPC

CAPC with mounted bus node CTEU-CO

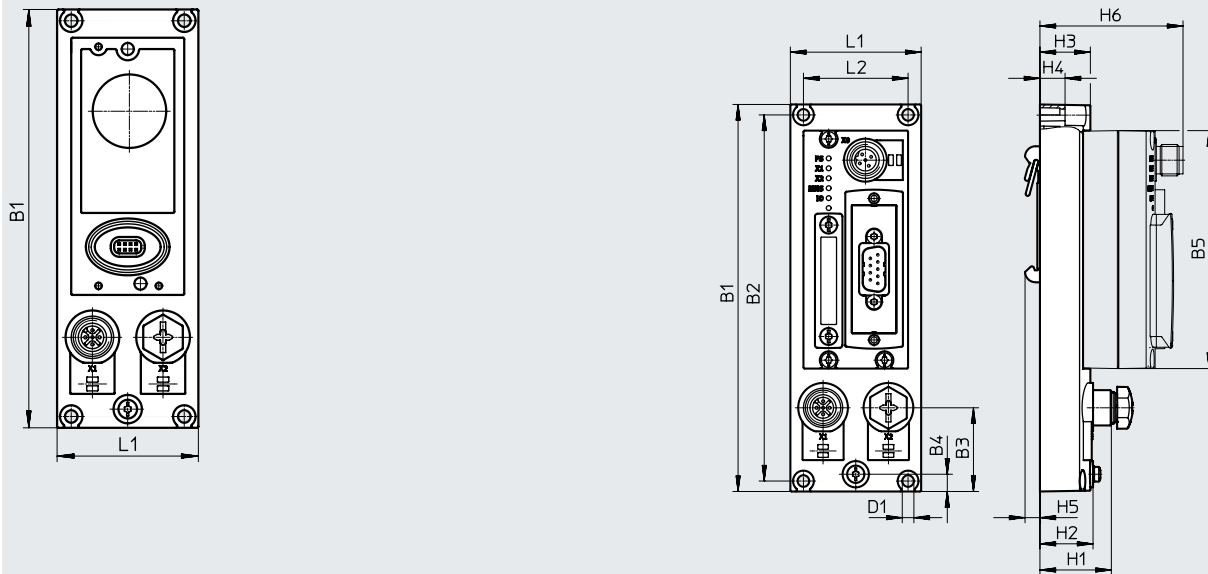

Type	B1	B2	B3	B4	B5	D1 $\varnothing$	H1	H2	H3	H4	H5	H6	L1	L2
CAPC	148	140	32	6.6	91	4.4	27.3	20.3	19.3	9.6	5.7	54.8	50	40

Ordering data

Part no. Type

Electrical connection block

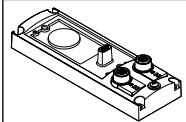

For connecting a second device with I-Port interface

570042

CAPC-F1-E-M12

H-rail mounting

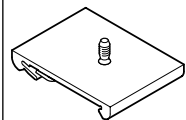

For electrical connection block CAPC

570043

CAFM-F1-H

## Accessories – Valve terminal

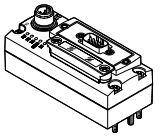
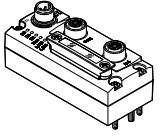
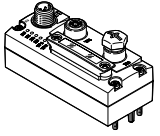
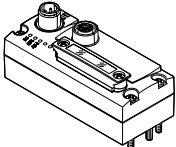
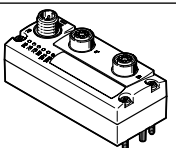
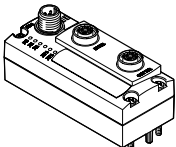
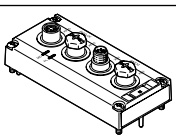
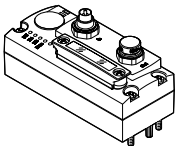

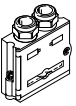
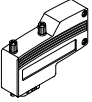
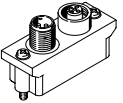
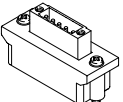
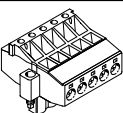
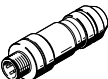
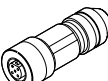
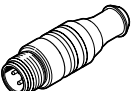
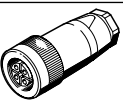
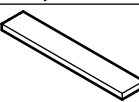

Ordering data – CTEU				
	Description		Part no.	Type
<b>Bus node</b>				
	CANopen bus node		570038	CTEU-CO
	CC-Link bus node		1544198	CTEU-CC
	PROFIBUS bus node		570040	CTEU-PB
			8107588	CTEU-PB-EX1C
	DeviceNet bus node		570039	CTEU-DN
	EtherCAT bus node		572556	CTEU-EC
	EtherNet/IP bus node		2798071	CTEU-EP
			8107591	CTEU-EP-EX1C
	AS-Interface bus node		572555	CTEU-AS
	PROFINET RT bus node		2201471	CTEU-PN
			8107589	CTEU-PN-EX1C
	VARAN bus node		8087559	CTEU-VN
<b>Electrical interface</b>				
	For direct integration of the valve terminal into the decentralised IO system CPX-API	12 valve positions	8081922	VAEM-L1-S-12-AP
		24 valve positions	8081923	VAEM-L1-S-24-AP
	For direct integration of the valve terminal into the decentralised CPI installation system from Festo		2149714	CTEU-CP

Accessories – Valve terminal

Ordering data – CTEU		Description	Part no.	Type
<b>Bus connection</b>				
	Sub-D plug, straight	For CANopen	532219	FBS-SUB-9-BU-2x5POL-B
		For CC Link	532220	FBS-SUB-9-GS-2x4POL-B
		For PROFIBUS	532216	FBS-SUB-9-GS-DP-B
	Sub-D plug, angled, 9-pin	For CANopen	533783	FBS-SUB-9-WS-CO-K
		For PROFIBUS	533780	FBS-SUB-9-WS-PB-K
	M12x1, 5-pin	A-coded, for CANopen	525632	FBA-2-M12-5POL
		B-coded, for PROFIBUS	533118	FBA-2-M12-5POL-RK
	For 5-pin terminal strip for CANopen		525634	FBA-1-SL-5POL
	Terminal strip, 5-pin, for DeviceNet/CANopen		525635	FBSD-KL-2x5POL
	Plug, straight, M12x1	5-pin, for CANopen	175380	FBS-M12-5GS-PG9
		4-pin, D-coded for EtherCAT	543109	NECU-M-S-D12G4-C2-ET
		5-pin, compatible with FBA-2-M12-5POL-RK for PROFIBUS	1066354	NECU-M-S-B12G5-C2-PB
	Straight socket, M12x1, 5-pin, for assembling a connecting cable compatible with FBA-2-M12-5POL-RK for PROFIBUS		1067905	NECU-M-B12G5-C2-PB
	Terminating resistor, M12, B-coded for PROFIBUS		1072128	CACR-S-B12G5-220-PB
<b>Plug socket</b>				
	For power supply, M12x1, 5-pin, B-coded for CANopen/DeviceNet		538999	NTSD-GD-9-M12-5POL-RK
	For power supply, M12x1, 5-pin for CC-Link, PROFIBUS, EtherCAT		18324	FBSD-GD-9-5POL
<b>Inscription label</b>				
	For bus node		565306	ASLR-C-E4





## Accessories – Valve terminal

Ordering data		Description	Part no.	Type	PU <sup>1)</sup>
<b>Push-in fitting, straight</b>		Datasheets → Internet: npqe			
	M3 thread	For tubing Ø 4 mm	8158773	NPQE-DK-M3-Q4-F1A-P10	10
	M5 thread	For tubing Ø 4 mm	8144595	NPQE-DK-M5-Q4-F1A-P10	10
		For tubing Ø 6 mm	8144596	NPQE-DK-M5-Q6-F1A-P10	10
	M7 thread	For tubing Ø 4 mm	8144597	NPQE-DK-M7-Q4-F1A-P10	10
		For tubing Ø 6 mm	8144598	NPQE-DK-M7-Q6-F1A-P10	10
	G1/8 thread	For tubing Ø 4 mm	8144599	NPQE-DK-G18-Q4-F1A-P10	10
		For tubing Ø 6 mm	8144600	NPQE-DK-G18-Q6-F1A-P10	10
		For tubing Ø 8 mm	8144601	NPQE-DK-G18-Q8-F1A-P10	10
		For tubing Ø 10 mm	8144602	NPQE-DK-G18-Q10-F1A-P10	10
	G1/4 thread	For tubing Ø 6 mm	8144603	NPQE-DK-G14-Q6-F1A-P10	10
		For tubing Ø 8 mm	8144604	NPQE-DK-G14-Q8-F1A-P10	10
		For tubing Ø 10 mm	8144605	NPQE-DK-G14-Q10-F1A-P10	10
		For tubing Ø 12 mm	8144606	NPQE-DK-G14-Q12-F1A-P10	10
<b>Push-in fitting, L-shaped</b>		Datasheets → Internet: npqe			
	M3 thread	For tubing Ø 4 mm	8158774	NPQE-L-M3-Q4-F1A-P10	10
	M5 thread	For tubing Ø 4 mm	8158775	NPQE-L-M5-Q4-F1A-P10	10
		For tubing Ø 6 mm	8158776	NPQE-L-M5-Q6-F1A-P10	10
	M7 thread	For tubing Ø 4 mm	8158777	NPQE-L-M7-Q4-F1A-P10	10
For tubing Ø 6 mm		8158778	NPQE-L-M7-Q6-F1A-P10	10	
	R1/4 thread	For tubing Ø 6 mm	8158783	NPQE-L-R14-Q6-F1A-P10	10
		For tubing Ø 8 mm	8158784	NPQE-L-R14-Q8-F1A-P10	10
		For tubing Ø 10 mm	8158785	NPQE-L-R14-Q10-F1A-P10	10
		For tubing Ø 12 mm	8158786	NPQE-L-R14-Q12-F1A-P10	10
	R1/8 thread	For tubing Ø 4 mm	8158779	NPQE-L-R18-Q4-F1A-P10	10
		For tubing Ø 6 mm	8158780	NPQE-L-R18-Q6-F1A-P10	10
		For tubing Ø 8 mm	8158781	NPQE-L-R18-Q8-F1A-P10	10
		For tubing Ø 10 mm	8158782	NPQE-L-R18-Q10-F1A-P10	10
<b>Push-in connector, straight</b>		Datasheets → Internet: npqe			
	Pneumatic port 1 for tubing Ø 4mm	Pneumatic port 2 for tubing Ø 4mm	8158787	NPQE-D-Q4-E-F1A-P10	10
	Pneumatic port 1 for tubing Ø 4mm	Pneumatic port 2 for tubing Ø 6mm	8158788	NPQE-D-Q6-Q4-F1A-P10	10
	Pneumatic port 1 for tubing Ø 6mm	Pneumatic port 2 for tubing Ø 6mm	8158789	NPQE-D-Q6-E-F1A-P10	10
	Pneumatic port 1 for tubing Ø 8mm	Pneumatic port 2 for tubing Ø 6mm	8158790	NPQE-D-Q8-Q6-F1A-P10	10
	Pneumatic port 1 for tubing Ø 8mm	Pneumatic port 2 for tubing Ø 8mm	8158791	NPQE-D-Q8-E-F1A-P10	10
	Pneumatic port 1 for tubing Ø 10mm	Pneumatic port 2 for tubing Ø 8mm	8158792	NPQE-D-Q10-Q8-F1A-P10	10
	Pneumatic port 1 for tubing Ø 10mm	Pneumatic port 2 for tubing Ø 10mm	8158793	NPQE-D-Q10-E-F1A-P10	10
	Pneumatic port 1 for tubing Ø 12mm	Pneumatic port 2 for tubing Ø 10mm	8158794	NPQE-D-Q12-Q10-F1A-P10	10
Pneumatic port 1 for tubing Ø 12mm	Pneumatic port 2 for tubing Ø 12mm	8158795	NPQE-D-Q12-E-F1A-P10	10	
<b>Push-in connector, L-shape</b>		Datasheets → Internet: npqe			
	For tubing Ø 4 mm		8158796	NPQE-L-Q4-E-F1A-P10	10
	For tubing Ø 6 mm		8158797	NPQE-L-Q6-E-F1A-P10	10
	For tubing Ø 8 mm		8158798	NPQE-L-Q8-E-F1A-P10	10
	For tubing Ø 10 mm		8158799	NPQE-L-Q10-E-F1A-P10	10

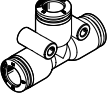
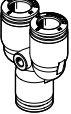

1) Packaging unit.

## Accessories – Valve terminal

Ordering data		Part no.	Type	PU <sup>1)</sup>
<b>Push-in connector, T-shape</b>		Datasheets → Internet: npqe		
	For tubing Ø 4 mm	8158800	NPQE-T-Q4-E-F1A-P10	10
	For tubing Ø 6 mm	8158801	NPQE-T-Q6-E-F1A-P10	10
	For tubing Ø 8 mm	8158802	NPQE-T-Q8-E-F1A-P10	10
	For tubing Ø 10 mm	8158803	NPQE-T-Q10-E-F1A-P10	10
<b>Push-in connector, Y-shape</b>		Datasheets → Internet: npqe		
	For tubing Ø 4 mm	8158804	NPQE-Y-Q4-E-F1A-P10	10
	For tubing Ø 6 mm	8158805	NPQE-Y-Q6-E-F1A-P10	10
	For tubing Ø 8 mm	8158806	NPQE-Y-Q8-E-F1A-P10	10
	For tubing Ø 10 mm	8158807	NPQE-Y-Q10-E-F1A-P10	10
<b>Blanking plug</b>		Datasheets → Internet: b		
	M5 thread	8142288	B-M5-F1A	1
	M7 thread	8144525	B-M7-F1A	1
	G1/8 thread	8142289	B-1/8-F1A	1
	G1/4 thread	8142290	B-1/4-F1A	1

1) Packaging unit.

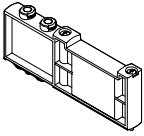
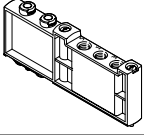
## Accessories – Valve terminal

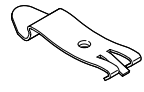
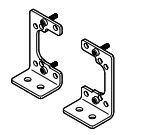
Ordering data		Description	Part no.	Type	PU <sup>1)</sup>	
<b>Cover plate</b>						
	Vacant position width 10 mm	Recommended for production facilities for manufacturing lithium-ion batteries	8141537	VABB-L1-10-T-F1A	1	
	Vacant position width 14 mm	Recommended for production facilities for manufacturing lithium-ion batteries	8141538	VABB-L1-14-T-F1A	1	
<b>Supply plate</b>						
	Supply ports 1, 3, 5, width 10 mm	Recommended for production facilities for manufacturing lithium-ion batteries	8141539	VABF-L1-10-P3A4-M7-T1-F1A	1	
	Supply ports 1, 3, 5, width 14 mm	Recommended for production facilities for manufacturing lithium-ion batteries	8141540	VABF-L1-14-P3A4-G18-T1-F1A	1	
<b>Separator</b>						
	For manifold rail, size 10, M5/M7	For sub-base valves	Recommended for production facilities for manufacturing lithium-ion batteries	8145478	VABD-6-B-F1A	1
		For semi in-line valves		8145479	VABD-8-B-F1A	1
	For all manifold rails, size 14		Recommended for production facilities for manufacturing lithium-ion batteries	8145480	VABD-10-B-F1A	1
	For all manifold rails, size 18		Recommended for production facilities for manufacturing lithium-ion batteries	8145481	VABD-12-B-F1A	1
<b>H-rail mounting</b>				Datasheets → Internet: vame		
	Use the following screws for mounting: Size 10: DIN 912: M4x30 Size 14: DIN 912: M4x40	Recommended for production facilities for manufacturing lithium-ion batteries	8142649	VAME-T-M4-F1A		
<b>Mounting bracket</b>				Datasheets → Internet: vame		
	Mounting bracket, right and left, with screw set for sub-base valve (control cabinet installation). Mounting is possible only with VTUG in size 10 and 14.		8154010	VAME-L1-Q		

1) Packaging unit.