

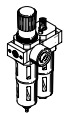

油雾器 LOE, D 系列

FESTO





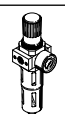
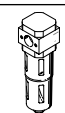
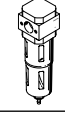
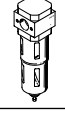
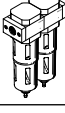
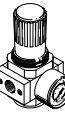

产品范围一览 – 气源处理元件, D 系列, 金属型

型号	规格	气接口										压力调节范围 [bar]			过滤等级 [µm]			
		M5	M7	G1/8	G1/4	G3/8	G1/2	G3/4	G1	QS4	QS6	0.5 … 7	0.5 … 12	2.5 … 12	0.01	1	5	40
气源处理装置																		
FRC/FRCS 	Mini	-	-	■	■	■	-	-	-	-	-	■	■	-	-	-	■	■
	Midi	-	-	-	■	■	■	■	-	-	-	■	■	-	-	-	■	■
	Maxi	-	-	-	-	-	■	■	■	-	-	■	■	-	-	-	■	■
气源处理装置组合																		
FRC-K 	Micro	-											■	■	-	-	-	■
	Mini	-	-	■	■	-	-	-	-	-	-	■	■	-	-	-	-	■
	Midi	-	-	-	■	■	■	-	-	-	-	■	■	-	-	-	-	■
	Maxi	-	-	-	-	-	■	■	-	-	-	-	■	■	-	-	-	■
LFR-K LFRS-K 	Micro	-																
	Mini	-	-	■	■	-	-	-	-	-	-	■	■	-	-	-	-	■
	Midi	-	-	-	■	■	■	-	-	-	-	■	■	-	-	-	-	■
	Maxi	-	-	-	-	-	■	■	-	-	-	-	■	■	-	-	-	■
单个设备																		
过滤减压阀 LFR/LFRS 	Micro	■	■	■	-	-	-	-	-	■	■	■	-	-	-	-	■	-
	Mini	-	-	■	■	■	-	-	-	-	■	■	-	-	-	-	■	■
	Midi	-	-	-	■	■	■	■	-	-	■	■	-	-	-	-	■	■
	Maxi	-	-	-	-	-	■	■	■	-	-	■	■	-	-	-	■	■
过滤器 LF 	Mini	-	-	■	■	■	-	-	-	-	-	-	-	-	-	-	■	■
	Midi	-	-	-	■	■	■	■	-	-	-	-	-	-	-	-	■	■
	Maxi	-	-	-	-	-	■	■	■	-	-	-	-	-	-	-	■	■
	精细和超精细 过滤器 LFMA/LFMB 	Micro	-															
Mini		-	-	■	■	■	-	-	-	-	-	-	-	■	■	-	-	-
Midi		-	-	-	■	■	■	■	-	-	-	-	-	■	■	-	-	-
Maxi		-	-	-	-	-	■	■	■	-	-	-	-	■	■	-	-	-
活性炭过滤器 LFX 	Micro	-																
	Mini	-	-	■	■	■	-	-	-	-	-	-	-	-	-	-	-	-
	Midi	-	-	-	■	■	■	■	-	-	-	-	-	-	-	-	-	-
	Maxi	-	-	-	-	-	■	■	■	-	-	-	-	-	-	-	-	-
过滤器组合 LFMBA 	Micro	-																
	Mini	-	-	■	■	■	-	-	-	-	-	-	-	■	■	-	-	-
	Midi	-	-	-	■	■	■	■	-	-	-	-	-	■	■	-	-	-
	Maxi	-	-	-	-	-	■	■	■	-	-	-	-	■	■	-	-	-
减压阀 LR/LRS 	Mini	-	-	■	■	■	-	-	-	-	-	■	■	-	-	-	-	-
	Midi	-	-	-	■	■	■	■	-	-	-	■	■	-	-	-	-	-
	Maxi	-	-	-	-	-	■	■	■	-	-	■	■	-	-	-	-	-

产品范围一览 – 气源处理元件, D 系列, 金属型

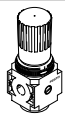
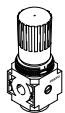
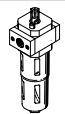
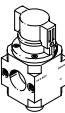
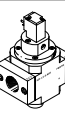
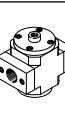
型号	规格	滤杯		冷凝水排放装置			压力显示		操作手柄锁		电源电压			选项			→ 页码/ Internet
		金属滤杯	塑料滤杯	手动旋转	半自动	全自动	带压力表	不带压力表	带锁销的旋转手柄	带挂锁的旋转手柄	24 V DC	110 V AC	230 V AC	直接驱动式减压阀, 带集成回流功能	先导驱动式减压阀, 带集成回流功能	压差显示	
气源处理装置																	
FRC/FRCS	Mini	■	-	■	-	■	■	■	■	■	-	-	-	-	-	-	frc
	Midi	■	-	■	-	■	■	■	■	■	-	-	-	-	-	-	
	Maxi	■	-	■	-	■	■	■	■	■	-	-	-	■	■	-	
气源处理装置组合																	
FRC-K	Micro	-	-	-	-	-	-	-	-	-	-	-	-	-	-	-	frc
	Mini	■	-	■	-	■	■	-	■	-	■	-	-	-	-	-	
	Midi	■	-	■	-	■	■	-	■	-	■	-	-	-	-	-	
	Maxi	■	-	■	-	■	■	-	■	-	■	-	-	■	■	-	
LFR-K LFRS-K	Micro	-	-	-	-	-	-	-	-	-	-	-	-	-	-	-	frc
	Mini	■	-	■	-	■	■	-	■	■	■	-	-	-	-	-	
	Midi	■	-	■	-	■	■	-	■	■	■	-	-	-	-	-	
	Maxi	■	-	■	-	■	■	-	■	■	■	-	-	■	■	-	
单个设备																	
过滤减压阀 LFR/LFRS	Micro	-	■	■	■	-	■	■	■	-	-	-	-	-	-	-	lfr
	Mini	■	-	■	-	■	■	■	■	■	-	-	-	-	-	-	
	Midi	■	-	■	-	■	■	■	■	■	-	-	-	-	-	-	
	Maxi	■	-	■	-	■	■	■	■	■	-	-	-	■	■	-	
过滤器 LF	Mini	■	-	■	-	■	-	-	-	-	-	-	-	-	-	-	lf
	Midi	■	-	■	-	■	-	-	-	-	-	-	-	-	-	-	
	Maxi	■	-	■	-	■	-	-	-	-	-	-	-	-	-	-	
精细和超精细 过滤器 LFMA/LFMB	Micro	-	-	-	-	-	-	-	-	-	-	-	-	-	-	-	lfma, lfmb
	Mini	■	-	■	-	■	-	-	-	-	-	-	-	-	-	■	
	Midi	■	-	■	-	■	-	-	-	-	-	-	-	-	-	■	
	Maxi	■	-	■	-	■	-	-	-	-	-	-	-	-	-	■	
活性炭过滤器 LFX	Micro	-	-	-	-	-	-	-	-	-	-	-	-	-	-	-	lfx
	Mini	■	-	-	-	-	-	-	-	-	-	-	-	-	-	-	
	Midi	■	-	-	-	-	-	-	-	-	-	-	-	-	-	-	
	Maxi	■	-	-	-	-	-	-	-	-	-	-	-	-	-	-	
过滤器组合 LFMBA	Micro	-	-	-	-	-	-	-	-	-	-	-	-	-	-	-	lfmba
	Mini	■	-	■	-	■	-	-	-	-	-	-	-	-	-	■	
	Midi	■	-	■	-	■	-	-	-	-	-	-	-	-	-	■	
	Maxi	■	-	■	-	■	-	-	-	-	-	-	-	-	-	■	
减压阀 LR/LRS	Mini	-	-	-	-	-	■	■	■	■	-	-	-	■	-	-	lr
	Midi	-	-	-	-	-	■	■	■	■	-	-	-	■	-	-	
	Maxi	-	-	-	-	-	■	■	■	■	-	-	-	■	■	-	
	Maxi	-	-	-	-	-	-	-	-	-	-	-	-	-	-	-	

产品范围一览 – 气源处理元件, D 系列, 金属型

型号	规格	气接口										压力调节范围 [bar]		
		M5	M7	G1/8	G1/4	G3/8	G1/2	G3/4	G1	QS4	QS6	0.5 ... 7	0.5 ... 12	
单个设备														
减压阀 LRB/LRBS		Micro	-											
		Mini	-	-	-	■	-	-	-	-	-	-	■	■
		Midi	-	-	-	-	■	-	-	-	-	-	■	■
		Maxi	-											
气路板集成安装减压阀 LRB-K		Micro	-											
		Mini	-	-	-	■	■	-	-	-	-	-	■	■
		Midi	-	-	-	-	■	■	-	-	-	-	■	■
		Maxi	-											
油雾器 LOE		Mini	-	-	■	■	■	-	-	-	-	-	-	
		Midi	-	-	-	■	■	■	■	-	-	-	-	
		Maxi	-	-	-	-	-	■	■	■	-	-	-	
开关阀 HE		Micro	-											
		Mini	-	-	■	■	■	-	-	-	-	-	-	
		Midi	-	-	-	■	■	■	■	-	-	-	-	
		Maxi	-	-	-	-	-	■	■	■	-	-	-	
开关阀 HEE		Micro	-											
		Mini	-	-	■	■	■	-	-	-	-	-	-	
		Midi	-	-	-	■	■	■	■	-	-	-	-	
		Maxi	-	-	-	-	-	■	■	■	-	-	-	
开关阀 HEP		Micro	-											
		Mini	-	-	■	■	■	-	-	-	-	-	-	
		Midi	-	-	-	■	■	■	■	-	-	-	-	
		Maxi	-	-	-	-	-	■	■	■	-	-	-	
软启动阀 HEL		Micro	-											
		Mini	-	-	■	■	■	-	-	-	-	-	-	
		Midi	-	-	-	■	■	■	■	-	-	-	-	
		Maxi	-	-	-	-	-	■	■	■	-	-	-	
膜片式空气干燥器 LDM1		Micro	-											
		Mini	-											
		Midi	-											
		Maxi	-	-	-	-	-	■	■	■	-	-	-	
分支模块 FRM		Micro	-											
		Mini	-	-	■	■	■	-	-	-	-	-	-	
		Midi	-	-	-	■	■	■	■	-	-	-	-	
		Maxi	-	-	-	-	-	■	■	■	-	-	-	
分气块 FRZ		Mini	-	-	-	-	-	-	-	-	-	-	-	
		Midi	-	-	-	-	-	-	-	-	-	-	-	
		Maxi	-	-	-	-	-	-	-	-	-	-	-	

产品范围一览 – 气源处理元件, D 系列, 金属型

型号	规格	滤杯		压力显示		操作手柄锁		电源电压			选项		→ 页码/ Internet	
		金属滤杯	塑料滤杯	带压力表	不带压力表	带锁销的旋转手柄	带挂锁的旋转手柄	24 V DC	110 V AC	230 V AC	带止回功能	压力开关		
单个设备														
减压阀 LRB/LRBS	Micro	-				■	■	■	-	-	-	-	-	lrb
	Mini	-	-	-	-	■	■	■	-	-	-	-	-	
	Midi	-	-	-	-	■	■	■	-	-	-	-	-	
	Maxi	-	-											
气路板集成安 装减压阀 LRB-K	Micro	-				■	■	-	-	-	-	-	-	lrb
	Mini	-	-	-	-	■	■	-	-	-	-	-	-	
	Midi	-	-	-	-	■	■	-	-	-	-	-	-	
	Maxi	-	-											
油雾器 LOE	Mini	■	-	-	-	■	-	-	-	-	-	-	-	6
	Midi	■	-	-	-	■	-	-	-	-	-	-	-	
	Maxi	■	-	-	-	■	-	-	-	-	-	-	-	
开关阀 HE	Micro	-				■	■	-	-	-	-	-	-	he
	Mini	-	-	-	-	■	■	-	-	-	-	-	-	
	Midi	-	-	-	-	■	■	-	-	-	-	-	-	
	Maxi	-	-	-	-	■	■	-	-	-	-	-	-	
开关阀 HEE	Micro	-				■	-	-	■	■	■	-	-	hee
	Mini	-	-	-	-	■	-	-	■	■	■	-	-	
	Midi	-	-	-	-	■	-	-	■	■	■	-	-	
	Maxi	-	-	-	-	■	-	-	■	■	■	-	-	
开关阀 HEP	Micro	-				■	-	-	-	-	-	-	-	hep
	Mini	-	-	-	-	■	-	-	-	-	-	-	-	
	Midi	-	-	-	-	■	-	-	-	-	-	-	-	
	Maxi	-	-	-	-	■	-	-	-	-	-	-	-	
软启动阀 HEL	Micro	-				■	-	-	-	-	-	-	-	hel
	Mini	-	-	-	-	■	-	-	-	-	-	-	-	
	Midi	-	-	-	-	■	-	-	-	-	-	-	-	
	Maxi	-	-	-	-	■	-	-	-	-	-	-	-	
膜片式空气干 燥器 LDM1	Micro	-												ldm1
	Mini	-												
	Midi	-												
	Maxi	■	-	-	-	■	-	-	-	-	-	-	-	
分支模块 FRM	Micro	-				■	-	-	-	-	-	■	■	frm
	Mini	-	-	-	-	■	-	-	-	-	-	■	■	
	Midi	-	-	-	-	■	-	-	-	-	-	■	■	
	Maxi	-	-	-	-	■	-	-	-	-	-	■	■	
分气块 FRZ	Mini	-	-	-	-	■	-	-	-	-	-	-	-	frz
	Midi	-	-	-	-	■	-	-	-	-	-	-	-	
	Maxi	-	-	-	-	■	-	-	-	-	-	-	-	

外围元件一览

Mini/Midi/Maxi

单个元件，带连接板

单个元件，不带连接板，用于气源处理装置组合

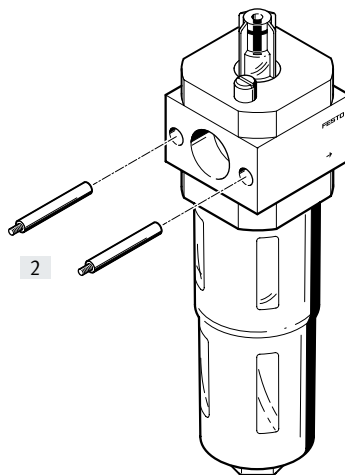
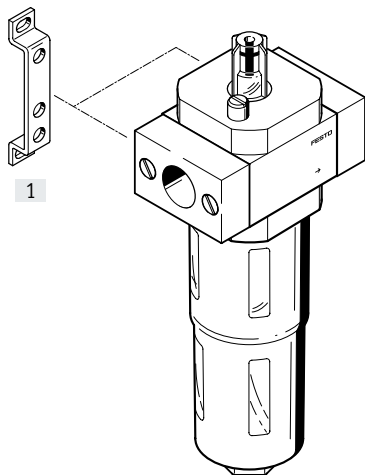

安装元件和附件

	单个设备		组合		→ 页码/Internet
	带连接板	不带连接板	带连接板	不带连接板	
[1] 安装支架 HFOE	■	-	■	-	hfoe-d
[2] 螺栓 (包括在供货范围内) FRB	-	-	■	■	frb-d

型号代码

001	系列	
LOE	油雾器	

002	气接口	
	无	
1/8	内螺纹 G1/8	
1/4	内螺纹 G1/4	
3/8	内螺纹 G3/8	
1/2	内螺纹 G1/2	
3/4	内螺纹 G3/4	
1	内螺纹 G1	

003	派生型	
D	D 系列, 金属型	

004	规格	
MINI	模块宽度 40 mm (不带连接板)	
MIDI	模块宽度 55 mm (不带连接板)	
MAXI	模块宽度 66 mm (不带连接板)	

技术参数

功能

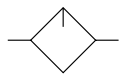

-  - 流量
160 ... 9000 l/min
-  - 温度范围
-10 ... +60 °C
-  - 工作压力
0 ... 16 bar



比例油雾器为压缩空气添加精确调节的润滑油。经过文丘里喷嘴的气流被用来从油罐里将油带到滴油帽中时，压力就会下降。

从油滴帽中，油滴被雾化，油雾的添加量与气源流量成正比。

- 比例油雾器，带高精度润滑油计量
- 减少高负载下驱动单元的磨损
- 大流量
- 加油便捷
- 坚固的金属壳体
- 金属滤杯带透明油杯

建议使用以下油品用于 Festo 元件：

粘度范围符合
ISO 3448, ISO 等级 VG 32
40 °C 时 32 mm²/s (= cSt)

- Festo 专用油 → 页码 13
- ARAL Vitam GF 32
- BP Energol HLP 32
- ESSO Nuto H 32
- Mobil DTE 24
- Shell Tellus Oil DO 32

主要技术参数			
规格	Micro	Mini	Midi
气接口 1, 2 ¹⁾	G1/8, G1/4, G3/8, - ²⁾	G1/4, G3/8, G1/2, G3/4, - ²⁾	G1/2, G3/4, G1, - ²⁾
结构特点	标准比例油雾器		
安装方式	通过附件 管式安装		
安装位置	垂直 ±5°		
输出的空气纯净度等级	压缩空气，符合 ISO 8573-1:2010 [7:4:4] 惰性气体		
滤杯	金属滤杯		
油雾器功能的最小流量 [l/min]	3	8	10
最大油容量 [cm ³]	45	110	190

1) 带螺纹接口的连接板

2) 不带连接板。

† 注意：该产品符合 ISO 1179-1 和 ISO 228-1。

技术参数

标准额定流量 $q_{nN}^{1)}$ [l/min]										
规格	Mini			Midi			Maxi			
气接口 1, 2	G1/8	G1/4	G3/8	G1/4	G3/8	G1/2	G3/4	G1/2	G3/4	G1
LOE	1300	2300	2700	2800	5500	6100	6300	8300	8400	9000

1) 测量条件: $p_1 = 6 \text{ bar}$ 和 $\Delta p = 1 \text{ bar}$.

工作和环境条件	
工作压力 [bar]	0 ... 16
工作介质	压缩空气, 符合 ISO 8573-1:2010 [7:4:4] 惰性气体
工作/先导介质注意事项	可用润滑介质 (今后须始终使用润滑介质)
环境温度 [°C]	-10 ... +60
介质温度 [°C]	-10 ... +60
贮存温度 [°C]	-10 ... +60
耐腐蚀等级 CRC ¹⁾	2

1) 详见 www.festo.com/x/topic/crc

重量 [g]				
规格	Mini	Midi	Maxi	
			接口 G1/2, G3/4	接口 G1
LOE	270	630	1100	1200

材料

剖面图

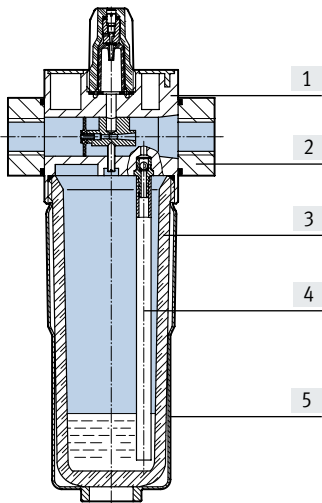

[1] 壳体	压铸锌/铝
[2] 连接板	压铸锌/铝
[3] 油杯	PC
[4] 气管	PU
[5] 金属滤杯	锻造铝合金
- 密封件	NBR
材料注意事项	RoHS 合规

技术参数

标准额定流量 q_n 与压差 Δp_{1-2} 的关系

LOE-1/4-D-MINI

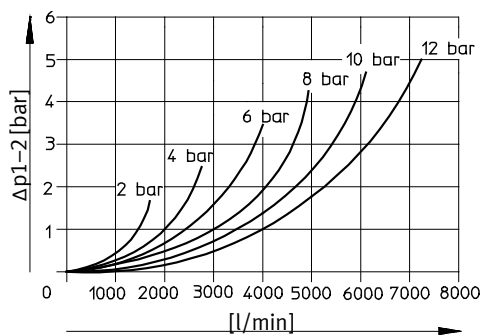

LOE-1/2-D-MIDI

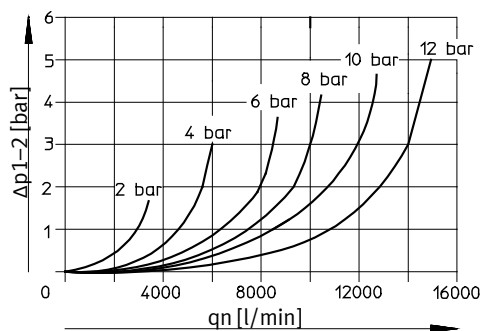

LOE-1-D-MAXI

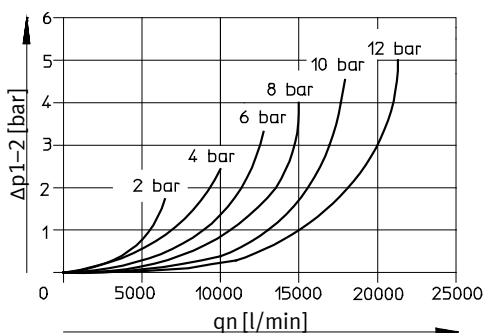

技术参数

CAD 相关数据 → www.festo.com

尺寸
带螺纹接口的连接板

不带连接板

[2] 金属滤杯 [4] 螺栓 (可更换) [5] 带孔螺丝, 用于油罐 → 气流方向
 [3] 安装尺寸 [6] 油量调节螺丝

型号	B1	B2	B3	B4	B5	D1	D2 ø	D3	D6 ø	H1	H2	L1	L2	L3	T1	T2	≈± 2
Mini																	
LOE-1/8-D-MINI	64	52	40	30	-	G1/8	-	M4	38	20	11	169	124	100	7	-	22
LOE-1/4-D-MINI						G1/4											
LOE-3/8-D-MINI	70					G3/8											
LOE-D-MINI	-	-			5.8	-	11			-	-				-	10	
Midi																	
LOE-1/4-D-MIDI	85	70	55	43	-	G1/4	-	M5	52	32	22	204	151	120	8	-	24
LOE-3/8-D-MIDI						G3/8											
LOE-1/2-D-MIDI						G1/2											
LOE-3/4-D-MIDI						G3/4											
LOE-D-MIDI	-	-			6.8	-	24			-	-				-	11	
Maxi																	
LOE-1/2-D-MAXI	96	80	66	46	-	G1/2	-	M5	65	32	22	228	170	150	8	-	24
LOE-3/4-D-MAXI						G3/4				40							
LOE-1-D-MAXI	116	91				G1				-	-				-	11	
LOE-D-MAXI	-	-			6.8	-	30			-	-				-	11	

† 注意: 该产品符合 ISO 1179-1 和 ISO 228-1。

技术参数

订货数据			
规格	接口	订货号	型号
不带连接板			
Mini	–	192575	LOE-D-MINI
Midi	–	192576	LOE-D-MIDI
Maxi	–	192577	LOE-D-MAXI
连接板, 带螺纹接口			
Mini	G1/8	159620	LOE-1/8-D-MINI
	G1/4	159621	LOE-1/4-D-MINI
	G3/8	162680	LOE-3/8-D-MINI
Midi	G1/4	186479	LOE-1/4-D-MIDI
	G3/8	159586	LOE-3/8-D-MIDI
	G1/2	159587	LOE-1/2-D-MIDI
	G3/4	162681	LOE-3/4-D-MIDI
Maxi	G1/2	186480	LOE-1/2-D-MAXI
	G3/4	159622	LOE-3/4-D-MAXI
	G1	159623	LOE-1-D-MAXI

附件

专用油



订货数据	订货号	型号
供货范围		
1 升	152811	OFSW-32