

Axial kits EAMM-A

FESTO



Festo Core Range
Covers the majority of your automation tasks

Worldwide:
Superb:
Easy:

Always in stock
Festo quality at an attractive price
Simplified procurement and warehousing

- ★ Generally ready for shipping ex works in 24 hours
In stock at 13 Service Centres worldwide
More than 2200 products
- ★ Generally ready for shipping ex works in 5 days
Assembled for you at 4 Service Centres worldwide
Up to 6×10^{12} variants per product family

Just look
for the
star!

Key features

At a glance

The following kits are used for coupling the motors and axes using friction-locking. The couplings transmit the drive energy of the motor to the axes. They can be connected to Festo motors or third-party motors.

The selection provides you with an overview of possible combinations. The planning tool "Electric Motion Sizing" helps you to find the right combination.

Electric Motion Sizing

Configuring electromechanical drives



Create the optimum drive package quickly and reliably. Electric Motion Sizing calculates suitable combinations of electric axis, electric motor and servo drive using just a few application details. It provides you with all the relevant data including the bill of materials and documentation for your selected combination. This avoids design errors and results in significantly improved energy efficiency for the system.

A smooth connection to the Festo Automation Suite also makes commissioning easier for you.

To find out more, go to www.festo.com/ems

Quickly find the right axis/motor combination with third-party motors

Select the required axis and note the code in the "Motor interface" column

Look for the interface code in the table of interfaces for third-party motors (→ from page 64) and check if the required third-party motor is listed

Zulässige Achs-/Motor-Kombinationen mit Elektrozyliner ESBF

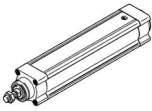

Schnittstellentabelle für Fremdmotoren
→ ab Seite 67
Technische Daten für Axialbausätze
→ ab Seite 72

Motor/Getriebe ¹⁾	Schnittstelle	Axialbausatz	
Typ	Motor	Teile-Nr.	Typ
ESBF-32			
mit Servomotor			
EMME-AS-40-...	40P	1976465	EAMM-A-D32-40P
		2207372	EAMM-A-D32-40P-S1 ²⁾
EMMS-AS-40-..., Fremdmotor	40A	543147	EAMM-A-D32-40A
		1322178	EAMM-A-D32-40A-S1 ²⁾

Fremdmotoren und Fremdgetriebe		
Schnittstelle	Hersteller	Typ
Fremdmotoren		
50AA	SEW Eurodrive	CMP40; CMP40S/IM
	Bosch Rexroth	MKD 025; MSK030B; MSK030C; MSK03x
	Danaher Motion	AKM21 AC; AKM21 AN; AKM22 AC; AKM22 AN; AKM23 AC; AKM23 AN; AKM24 AC; AKM24 AN; AKM2x-AC/AN
	Beckhoff	AM3021; AM3022; AM3023; AM3024
	B+R Automation	8ISA2
Mitsubishi	AKM21; AKM21x-Ax; AKM22; AKM22x-Ax; AKM23; AKM23x-Ax; AKM24; AKM24x-Ax	
60AA	Fastech	EzM2-60S/M/L

Overview of interfaces

Axis mechanism interface	
D19	EGSL-35
D32	ESBF-32, EGSL-45, ERMB-20, EHMB-20
D32-35A	ERMB-20, EHMB-20
D40	ESBF-40, EGSL-55, ERMB-25, EHMB-25
D50	ESBF-50
D60	ESBF-63, EGSL-75, ERMB-32, EHMB-32
D80	ESBF-80
D100	ESBF-100
L27	EGC-50-...-TB
L38	EGC-70-...-TB, ELGD-TB-100
L48	EGC-80-...-TB, ELGD-TB-80
L62	EGC-120-...-TB
L95	EGC-185-...-TB
M43	EGC-HD-125-...-TB
M48	EGC-HD-160-...-TB
M80	EGC-HD-220-...-TB
N38	ELGA-TB-...-70
N48	ELGA-TB-...-80, ELCC-TB-...-60, ELCC-TB-...-70, ELGD-TB-60
N80	ELGA-TB-...-120, ELCC-TB-...-90
L95	ELGA-TB-...-150, ELCC-TB-...-110
P3-28D	EGSK-15
P4-28B	EGSK-20
P5-28B	EGSK-26
P6-38A	EGSK-33
P8-38A	EGSK-46
R27	ELGG-...-35, ELGR-...-35
R38	ELGG-...-45, ELGR-...-45
R48	ELGG-...-55, ELGR-...-55
S38	EGC-70-...-BS, EGC-HD-125-...-BS, ELGA-BS-...-70
S48	EGC-80-...-BS, EGC-HD-160-...-BS, ELGA-BS-...-80
S62	EGC-120-...-BS, EGC-HD-220-...-BS, ELGA-BS-...-120
S95	EGC-185-...-BS, ELGA-BS-...-150
V20	EPCC-25, EGSC-25
V25	EPCC-32, EGSC-32, ELGC-BS-32
V32	EPCC-45, EGSC-45, ELGC-BS-45, ELGC-TB-45
T42	EPCC-60, EGSC-60, ELGC-BS-60, ELGC-TB-60, ELGD-BS-60/100
T46	ELGC-BS-80, ELGC-TB-80, ELGT-BS-90/-120/-160, ELGD-BS-80
X48	EXCM-40, EXCH-40
X62	EXCH-60
Y62	EXCT-30

Motor interface	
28A	Stepper motor EMMS-ST-28
28AA	Third-party motor
38AA	Third-party motor

40A	Third-party motor
40G	Gear unit EMGA-40, third-party gear unit
40P	Servo motor EMME-AS-40, EMMB-AS-40, third-party motor
40R	Third-party motor
40RA	Third-party motor
42A	Stepper motor EMMS-ST-42, third-party motor
42AB	Third-party motor
50GA	Third-party motor
55A	Third-party motor
57A	Stepper motor EMMS-ST-57
57AA	Third-party motor
58AA	Third-party motor
60AA	Third-party motor
60AB	Third-party motor
60G	Gear unit EMGA-60-P-...-SAS/SST
60H	Gear unit EMGA-60-...-EAS, third-party motor
60P	Servo motor EMMT-AS-60, EMME-AS-60, EMMB-AS-60, third-party motor
60PA	Third-party motor
60R	Third-party motor
60RA	Third-party motor
70A	Third-party motor
70AA	Third-party motor
70GA	Third-party gear unit
80G	Gear unit EMGA-80, third-party gear unit
80P	Servo motor EMMT-AS-80, EMME-AS-80, EMMB-AS-80, third-party motor
80PA	Third-party motor
80PB	Third-party motor
82AA	Third-party motor
84AA	Third-party motor
85AA	Third-party motor
87A	Stepper motor EMMS-ST-87
90GA	Third-party motor
100A	Servo motor EMMT-AS-100, EMME-AS-100, third-party motor
120G	Gear unit EMGA-120-...-SAS, third-party gear unit
150A	Servo motor EMMT-AS-150
160G	Gear unit EMGA-160-...-SAS, third-party gear unit
190A	Servo motor EMMT-AS-190

Product range overview

Permissible axis/motor combinations with electric cylinder EPCC

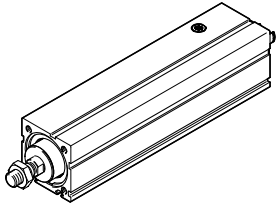

Table of interfaces for third-party motors

→ from page 64

Technical data for axial kits

→ from page 69

Motor ¹⁾ Type	Motor interface	Axial kit	
		Part no.	Type
EPCC-25			
With stepper motor			
EMMS-ST-28-...	28A	4505258	EAMM-A-V20-28A
Third-party motor	28AA	8093016	EAMM-A-V20-28AA
EPCC-32			
With servo motor			
Third-party motor	38AA	8093162	EAMM-A-V25-38AA
EMME-AS-40-..., EMMB-AS-40-...	40P	4491059	EAMM-A-V25-40P
Third-party motor	40R	8087062	EAMM-A-V25-40R
Third-party motor	40RA	8094100	EAMM-A-V25-40RA
With stepper motor			
Third-party motor	35A, 35AB	8093255	EAMM-A-V25-35A
EMMS-ST-42-..., third-party motor	42A	4582608	EAMM-A-V25-42A
Third-party motor	42AB	8094108	EAMM-A-V25-42AB
EPCC-45			
With servo motor			
Third-party motor	38AA	8093023	EAMM-A-V32-38AA
EMME-AS-40-..., EMMB-AS-40-...	40P	4595742	EAMM-A-V32-40P
Third-party motor	40R	8087090	EAMM-A-V32-40R
Third-party motor	40RA	8094180	EAMM-A-V32-40RA
Third-party motor	58AA	8098982	EAMM-A-V32-58AA
EMMT-AS-60-..., EMME-AS-60-..., EMMB-AS-60-...	60P	4608750	EAMM-A-V32-60P
Third-party motor	60PA	8091053	EAMM-A-V32-60PA
Third-party motor	60RA	8093041	EAMM-A-V32-60RA
With stepper motor			
EMMS-ST-42-..., third-party motor	42A	4281142	EAMM-A-V32-42A
Third-party motor	42AB	8094200	EAMM-A-V32-42AB
EMMS-ST-57-...	57A	4597016	EAMM-A-V32-57A
Third-party motor	60AA	8092271	EAMM-A-V32-60AA
EPCC-60			
With servo motor			
Third-party motor	55A	8082614	EAMM-A-T42-55A
Third-party motor	58AA	8094935	EAMM-A-T42-58AA
EMMT-AS-60-..., EMME-AS-60-..., EMMB-AS-60-...	60P, 60PA	4133487	EAMM-A-T42-60P
Third-party motor	60R	8093289	EAMM-A-T42-60R
Third-party motor	60RA	8092264	EAMM-A-T42-60RA
EMMT-AS-80-..., EMME-AS-80-..., EMMB-AS-80-...	80P	4623788	EAMM-A-T42-80P
With stepper motor			
EMMS-ST-57-...	57A	4327034	EAMM-A-T42-57A
Third-party motor	60AA	8092255	EAMM-A-T42-60AA
Third-party motor	60AB	8094949	EAMM-A-T42-60AB
EMMS-ST-87-...	87A	4610008	EAMM-A-T42-87A

1) The input torque must not exceed the max. permissible transferable torque of the axial kit.

Product range overview

Permissible axis/motor combinations with electric cylinder ESBF

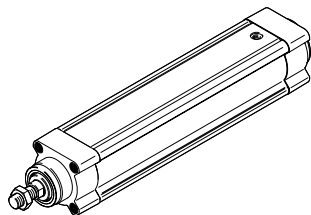

Table of interfaces for third-party motors

→ from page 64

Technical data for axial kits

→ from page 69

Motor/gear unit ¹⁾	Motor interface	Axial kit	
		Part no.	Type
ESBF-32			
With servo motor			
EMME-AS-40-..., EMMB-AS-40-...	40P	★ 1976465 2207372	EAMM-A-D32-40P EAMM-A-D32-40P-S1 ²⁾
Third-party motor	40A	543147 1322178	EAMM-A-D32-40A EAMM-A-D32-40A-S1 ²⁾
Third-party motor	40R	8105826	EAMM-A-D32-40R
Third-party motor	40RA	8125610	EAMM-A-D32-40RA
Third-party motor	55A	550979 1322180	EAMM-A-D32-55A EAMM-A-D32-55A-S1 ²⁾
Third-party motor	58AA	8105884	EAMM-A-D32-58AA
EMMT-AS-60-..., EMME-AS-60-..., EMMB-AS-60-..., third-party motor	60P	★ 1956054 2234020	EAMM-A-D32-60P EAMM-A-D32-60P-S1 ²⁾
Third-party motor	60R	8105918	EAMM-A-D32-60R
Third-party motor	60RA	8105889	EAMM-A-D32-60RA
With servo motor and gear unit			
EMME-AS-40-... EMGA-40-P-G...-EAS-40	40G	1454238 2256396	EAMM-A-D32-40G EAMM-A-D32-40G-S1 ²⁾
EMMT-AS-60-..., EMME-AS-60-... EMGA-60-P-G...-EAS-60	60H	2946760 2946761	EAMM-A-D32-60H EAMM-A-D32-60H-S1 ²⁾
With servo motor and right-angle gear unit			
EMME-AS-40-..., EMMB-AS-40-... EMGA-40-A-G...-40P	40G	1454238 2256396	EAMM-A-D32-40G EAMM-A-D32-40G-S1 ²⁾
EMMT-AS-60-..., EMME-AS-60-..., EMMB-AS-60-... EMGA-60-A-G...-60P	60H	2946760 2946761	EAMM-A-D32-60H EAMM-A-D32-60H-S1 ²⁾
With stepper motor			
Third-party motor	60AA	8105887	EAMM-A-D32-60AA

1) The input torque must not exceed the max. permissible transferable torque of the axial kit.

2) Increased degree of protection IP65

Festo Core Range



Generally ready for shipping ex works in 24 hours

Generally ready for shipping ex works in 5 days

Product range overview

Permissible axis/motor combinations with electric cylinder ESBF

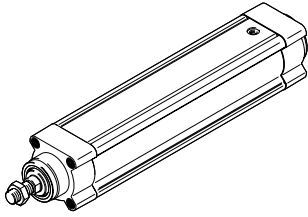

Table of interfaces for third-party motors

→ from page 64

Technical data for axial kits

→ from page 69

Motor/gear unit ¹⁾ Type	Motor interface	Axial kit	
		Part no.	Type
ESBF-32			
With stepper motor			
EMMS-ST-42-..., third-party motor	42A	★ 543148	EAMM-A-D32-42A
		1322179	EAMM-A-D32-42A-S1 ²⁾
EMMS-ST-57-..., third-party motor	57A	★ 550980	EAMM-A-D32-57A
		1322181	EAMM-A-D32-57A-S1 ²⁾
Third-party motor	60AA	8105887	EAMM-A-D32-60AA
With stepper motor and gear unit			
EMMS-ST-42-... EMGA-40-P-G...-SST-42	40G	1454238	EAMM-A-D32-40G
		2256396	EAMM-A-D32-40G-S1 ²⁾
EMMS-ST-57-... EMGA-60-P-G...-SST-57	60G	2946758	EAMM-A-D32-60G
		2946759	EAMM-A-D32-60G-S1 ²⁾
With third-party gear unit			
Third-party gear unit	40G	1454238	EAMM-A-D32-40G
		2256396	EAMM-A-D32-40G-S1 ²⁾
Third-party gear unit	50GA	8117072	EAMM-A-D32-50GA
Third-party gear unit	60H	2946760	EAMM-A-D32-60H
		2946761	EAMM-A-D32-60H-S1 ²⁾

1) The input torque must not exceed the max. permissible transferable torque of the axial kit.

2) Increased degree of protection IP65



Product range overview

Permissible axis/motor combinations with electric cylinder ESBF

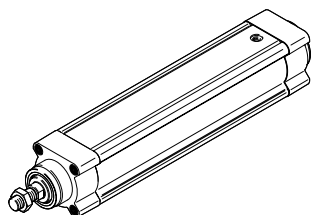

Table of interfaces for third-party motors

→ from page 64

Technical data for axial kits

→ from page 69

Motor/gear unit ¹⁾	Motor interface	Axial kit	
		Part no.	Type
ESBF-40			
With servo motor			
Third-party motor	55A	543153 1322182	EAMM-A-D40-55A EAMM-A-D40-55A-S1 ²⁾
Third-party motor	58AA	8105928	EAMM-A-D40-58AA
EMMT-AS-60-..., EMME-AS-60-..., EMMB-AS-60-..., third-party motor	60P	★ 1977000 2151519	EAMM-A-D40-60P EAMM-A-D40-60P-S1 ²⁾
Third-party motor	60R	8117079	EAMM-A-D40-60R
Third-party motor	60RA	8117078	EAMM-A-D40-60RA
Third-party motor	70A	550981 1322185	EAMM-A-D40-70A EAMM-A-D40-70A-S1 ²⁾
Third-party motor	70AA, 70AB	8105952	EAMM-A-D40-70AA
With servo motor and gear unit			
EMME-AS-40-... EMGA-40-P-G-...-EAS-40	40G	2256398 2256399	EAMM-A-D40-40G-G2 ²⁾ EAMM-A-D40-40G-S1 ²⁾
EMMT-AS-60-..., EMME-AS-60-... EMGA-60-P-G-...-EAS-60	60H	1454242 2256401	EAMM-A-D40-60H EAMM-A-D40-60H-S1 ²⁾
With servo motor and right-angle gear unit			
EMME-AS-40-..., EMMB-AS-40-... EMGA-40-A-G-...-40P	40G	2256398 2256399	EAMM-A-D40-40G-G2 ²⁾ EAMM-A-D40-40G-S1 ²⁾
EMMT-AS-60-..., EMME-AS-60-..., EMMB-AS-60-... EMGA-60-A-G-...-60P	60H	1454242 2256401	EAMM-A-D40-60H EAMM-A-D40-60H-S1 ²⁾
With stepper motor			
EMMS-ST-57-...	57A	543154 1322183	EAMM-A-D40-57A EAMM-A-D40-57A-S1 ²⁾
Third-party motor	60AA	8105929	EAMM-A-D40-60AA
EMMS-ST-87-...	87A	★ 550982 1322186	EAMM-A-D40-87A EAMM-A-D40-87A-S1 ²⁾
With stepper motor and gear unit			
EMMS-ST-42-... EMGA-40-P-G-...-SST-42	40G	2256398 2256399	EAMM-A-D40-40G-G2 ²⁾ EAMM-A-D40-40G-S1 ²⁾
EMMS-ST-57-... EMGA-60-P-G-...-SST-57	60G	2256400 2256409	EAMM-A-D40-60G EAMM-A-D40-60G-S1 ²⁾
With third-party gear unit			
Third-party gear unit	40G	2256398 2256399	EAMM-A-D40-40G-G2 ²⁾ EAMM-A-D40-40G-S1 ²⁾
Third-party gear unit	50GA	8117076	EAMM-A-D40-50GA
Third-party gear unit	60H	1454242 2256401	EAMM-A-D40-60H EAMM-A-D40-60H-S1 ²⁾

1) The input torque must not exceed the max. permissible transferable torque of the axial kit.

2) Increased degree of protection IP65

3) The axial kit can be retrofitted from IP40 to IP65 with the help of a seal set EADS-F → page 61.

Festo Core Range



Generally ready for shipping ex works in 24 hours

Generally ready for shipping ex works in 5 days

Product range overview

Permissible axis/motor combinations with electric cylinder ESBF

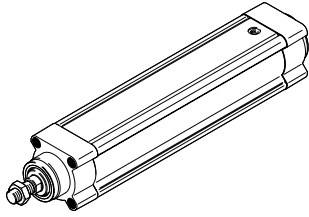

Table of interfaces for third-party motors

→ from page 64

Technical data for axial kits

→ from page 69

Motor/gear unit ¹⁾	Motor interface	Axial kit	
		Part no.	Type
ESBF-50			
With servo motor			
Third-party motor	70A	2733783	EAMM-A-D50-70A
		2734287	EAMM-A-D50-70A-S1 ²⁾
EMMT-AS-80-..., EMME-AS-80-..., EMMB-AS-80-..., third-party motor	80P	★ 2733785	EAMM-A-D50-80P
		2734289	EAMM-A-D50-80P-S1 ²⁾
Third-party motor	80PB, 80R	8123493	EAMM-A-D50-80PB
Third-party motor	82AA	8123491	EAMM-A-D50-82AA
Third-party motor	84AA	8123490	EAMM-A-D50-84AA
EMMT-AS-100-..., EMME-AS-100-..., third-party motor	100A	★ 2733784	EAMM-A-D50-100A
		2734288	EAMM-A-D50-100A-S1 ²⁾
With servo motor and gear unit			
EMMT-AS-60-..., EMME-AS-60-... EMGA-60-P-G...-EAS-60	60H	2733796	EAMM-A-D50-60H
		2907418	EAMM-A-D50-60H-S1 ²⁾
EMMT-AS-80-..., EMME-AS-80-... EMGA-80-P-G...-EAS-80	80G	2733787	EAMM-A-D50-80G
		2734291	EAMM-A-D50-80G-S1 ²⁾
EMMT-AS-100-..., EMME-AS-100-... EMGA-80-P-G...-SAS-100	80G	2733787	EAMM-A-D50-80G
		2734291	EAMM-A-D50-80G-S1 ²⁾
With servo motor and right-angle gear unit			
EMMT-AS-60-..., EMME-AS-60-..., EMMB-AS-60-... EMGA-60-A-G...-60P	60H	2733796	EAMM-A-D50-60H
		2907418	EAMM-A-D50-60H-S1 ²⁾
EMMT-AS-80-..., EMME-AS-80-..., EMMB-AS-80-... EMGA-80-A-G...-80P	80G	2733787	EAMM-A-D50-80G
		2734291	EAMM-A-D50-80G-S1 ²⁾
EMMT-AS-100-..., EMME-AS-100-... EMGA-80-A-G...-100A	80G	2733787	EAMM-A-D50-80G
		2734291	EAMM-A-D50-80G-S1 ²⁾
With third-party gear unit			
Third-party gear unit	70GA	8123492	EAMM-A-D50-70GA
With stepper motor			
EMMS-ST-87-...	87A	★ 2733781	EAMM-A-D50-87A
		2734286	EAMM-A-D50-87A-S1 ²⁾
With stepper motor and gear unit			
EMMS-ST-57-... EMGA-60-P-G...-SST-57	60G	2733786	EAMM-A-D50-60G
		2734290	EAMM-A-D50-60G-S1 ²⁾
EMMS-ST-87-... EMGA-80-P-G...-SST-87	80G	2733787	EAMM-A-D50-80G
		2734291	EAMM-A-D50-80G-S1 ²⁾
With third-party gear unit			
Third-party gear unit	60G	2733786	EAMM-A-D50-60G
		2734290	EAMM-A-D50-60G-S1 ²⁾
Third-party gear unit	60H	2733796	EAMM-A-D50-60H
		2907418	EAMM-A-D50-60H-S1 ²⁾
Third-party gear unit	80G	2733787	EAMM-A-D50-80G
		2734291	EAMM-A-D50-80G-S1 ²⁾

1) The input torque must not exceed the max. permissible transferable torque of the axial kit.

2) Increased degree of protection IP65

Festo Core Range



Generally ready for shipping ex works in 24 hours

Generally ready for shipping ex works in 5 days

Product range overview

Permissible axis/motor combinations with electric cylinder ESBF

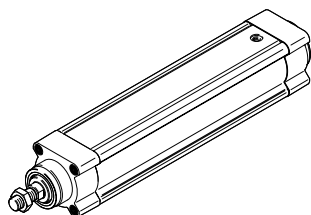

Table of interfaces for third-party motors

→ from page 64

Technical data for axial kits

→ from page 69

Motor/gear unit ¹⁾ Type	Motor interface	Axial kit	
		Part no.	Type
ESBF-63			
With servo motor			
Third-party motor	70A	543161	EAMM-A-D60-70A
		2256699	EAMM-A-D60-70A-S1 ²⁾
EMMT-AS-80-..., EMME-AS-80-..., EMMB-AS-80-..., third-party motor	80P	★ 1977073	EAMM-A-D60-80P
		2218564	EAMM-A-D60-80P-S1 ²⁾
Third-party motor	80PB, 80R	8105937	EAMM-A-D60-80PB
Third-party motor	84AA	8105945	EAMM-A-D60-84AA
Third-party motor	92RA	8159834	EAMM-A-D60-92RA
EMMT-AS-100-..., EMME-AS-100-..., third-party motor	100A	★ 550983	EAMM-A-D60-100A
		2256700	EAMM-A-D60-100A-S1 ²⁾
With servo motor and gear unit			
EMMT-AS-60-..., EMME-AS-60-..., EMGA-60-P-G...-EAS-60	60H	1454245	EAMM-A-D60-60H
		2256697	EAMM-A-D60-60H-S1 ²⁾
EMMT-AS-80-..., EMME-AS-80-..., EMGA-80-P-G...-EAS-80	80G	1499402	EAMM-A-D60-80G
		2946762	EAMM-A-D60-80G-S1 ²⁾
EMMT-AS-100-..., EMME-AS-100-..., EMGA-80-P-G...-SAS-100	80G	1499402	EAMM-A-D60-80G
		2946762	EAMM-A-D60-80G-S1 ²⁾
With servo motor and right-angle gear unit			
EMMT-AS-60-..., EMME-AS-60-..., EMMB-AS-60-..., EMGA-60-A-G...-60P	60H	1454245	EAMM-A-D60-60H
		2256697	EAMM-A-D60-60H-S1 ²⁾
EMMT-AS-80-..., EMME-AS-80-..., EMMB-AS-80-..., EMGA-80-A-G...-80P	80G	1499402	EAMM-A-D60-80G
		2946762	EAMM-A-D60-80G-S1 ²⁾
EMMT-AS-100-..., EMME-AS-100-..., EMGA-80-A-G...-100A	80G	1499402	EAMM-A-D60-80G
		2946762	EAMM-A-D60-80G-S1 ²⁾

- 1) The input torque must not exceed the max. permissible transferable torque of the axial kit.
- 2) Increased degree of protection IP65
- 3) The axial kit can be retrofitted from IP40 to IP65 with the help of a seal set EADS-F → page 110.

Festo Core Range



Generally ready for shipping ex works in 24 hours

Generally ready for shipping ex works in 5 days

Product range overview

Permissible axis/motor combinations with electric cylinder ESBF

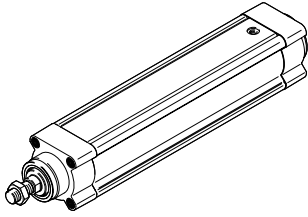

Table of interfaces for third-party motors

→ from page 64

Technical data for axial kits

→ from page 69

Motor/gear unit ¹⁾ Type	Motor interface	Axial kit	
		Part no.	Type
ESBF-63			
With stepper motor			
EMMS-ST-87-...	87A	★ 543162	EAMM-A-D60-87A
		1322188	EAMM-A-D60-87A-S1 ²⁾
With stepper motor and gear unit			
EMMS-ST-57-... EMGA-60-P-G...-SST-57	60G	2256696	EAMM-A-D60-60G-G2 ³⁾
		2256698	EAMM-A-D60-60G-S1 ²⁾
EMMS-ST-87-... EMGA-80-P-G...-SST-87	80G	1499402	EAMM-A-D60-80G
		2946762	EAMM-A-D60-80G-S1 ²⁾
With third-party gear unit			
Third-party gear unit	60H	1454245	EAMM-A-D60-60H
		2256697	EAMM-A-D60-60H-S1 ²⁾
Third-party gear unit	80G	1499402	EAMM-A-D60-80G
		2946762	EAMM-A-D60-80G-S1 ²⁾
Third-party gear unit	90GA	8105944	EAMM-A-D60-90GA

1) The input torque must not exceed the max. permissible transferable torque of the axial kit.

2) Increased degree of protection IP65

3) The axial kit can be retrofitted from IP40 to IP65 with the help of a seal set EADS-F → page 110.



Product range overview

Permissible axis/motor combinations with electric cylinder ESBF

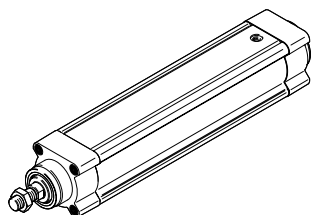

Table of interfaces for third-party motors

→ from page 64

Technical data for axial kits

→ from page 69

Motor/gear unit ¹⁾	Motor interface	Axial kit	
		Part no.	Type
ESBF-80			
With servo motor			
Third-party motor	84AA	8110055	EAMM-A-D80-84AA
EMMT-AS-100-..., EMME-AS-100-..., third-party motor	100A	1589665	EAMM-A-D80-100A
		1600673	EAMM-A-D80-100A-S1 ²⁾
EMMT-AS-150	150A	8157273	EAMM-A-D80-150A
		8157274	EAMM-A-D80-150A-S1 ²⁾
With servo motor and gear unit			
EMMT-AS-80-..., EMME-AS-80-... EMGA-80-P-G...-EAS-80	80G	2946763	EAMM-A-D80-80G
		2946764	EAMM-A-D80-80G-S1 ²⁾
EMMT-AS-100-..., EMME-AS-100-... EMGA-80-P-G...-SAS-100	80G	2946763	EAMM-A-D80-80G
		2946764	EAMM-A-D80-80G-S1 ²⁾
With servo motor and right-angle gear unit			
EMMT-AS-80-..., EMME-AS-80-..., EMMB-AS-80-... EMGA-80-A-G...-80P	80G	2946763	EAMM-A-D80-80G
		2946764	EAMM-A-D80-80G-S1 ²⁾
EMMT-AS-100-..., EMME-AS-100-... EMGA-80-A-G...-100A	80G	2946763	EAMM-A-D80-80G
		2946764	EAMM-A-D80-80G-S1 ²⁾
With stepper motor and gear unit			
EMMS-ST-87-... EMGA-80-P-G...-SST-87	80G	2946763	EAMM-A-D80-80G
		2946764	EAMM-A-D80-80G-S1 ²⁾
With third-party gear unit			
Third-party gear unit	80G	2946763	EAMM-A-D80-80G
		2946764	EAMM-A-D80-80G-S1 ²⁾
Third-party gear unit	90GA	8110063	EAMM-A-D80-90GA
ESBF-100			
With servo motor			
EMMT-AS-100-..., EMME-AS-100-..., third-party motor	100A	3356796	EAMM-A-D100-100A
		3356931	EAMM-A-D100-100A-S1 ²⁾
EMMT-AS-150	150A	8157275	EAMM-A-D100-150A
		8157276	EAMM-A-D100-150A-S1 ²⁾
With servo motor and gear unit			
EMMT-AS-100-..., EMME-AS-100-... EMGA-120-P-G...-SAS-100	120G	2449341	EAMM-A-D100-120G
		2946765	EAMM-A-D100-120G-S1 ²⁾
EMMT-AS-150-... EMGA-120-P-G...-SAS-140	120G	2449341	EAMM-A-D100-120G
		2946765	EAMM-A-D100-120G-S1 ²⁾
With third-party gear unit			
Third-party gear unit	120G	2449341	EAMM-A-D100-120G
		2946765	EAMM-A-D100-120G-S1 ²⁾

1) The input torque must not exceed the max. permissible transferable torque of the axial kit.

2) Increased degree of protection IP65

Product range overview

Permissible axis/motor combinations with toothed belt axis EGC-TB

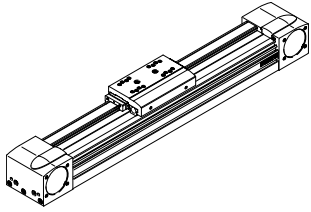

Table of interfaces for third-party motors

→ from page 64

Technical data for axial kits

→ from page 69

Motor/gear unit ¹⁾ Type	Interface Motor	Axial kit	
		Part no.	Type
EGC-50-...-TB			
With servo motor			
Third-party motor	40A	8063444	EAMM-A-L27-40A
Third-party motor	40R	8063445	EAMM-A-L27-40R
Third-party motor	40RA	8063446	EAMM-A-L27-40RA
Third-party motor	55A	557975	EAMM-A-L27-55A
Third-party motor	58AA	8063448	EAMM-A-L27-58AA
Third-party motor	60RA	8063452	EAMM-A-L27-60RA
Third-party motor	60RB	8063453	EAMM-A-L27-60RB
With servo motor and gear unit			
EMME-AS-40-... EMGA-40-P-G...-EAS-40	40G	☆ 557974	EAMM-A-L27-40G
With servo motor and right-angle gear unit			
EMME-AS-40-... , EMMB-AS-40-... EMGA-40-A-G...-40P	40G	☆ 557974	EAMM-A-L27-40G
With stepper motor			
EMMS-ST-42-..., third-party motor	42A	8063447	EAMM-A-L27-42A
EMMS-ST-57-...	57A	☆ 560678	EAMM-A-L27-57A
Third-party motor	57AA	8063449	EAMM-A-L27-57AA
Third-party motor	57AB	8063450	EAMM-A-L27-57AB
Third-party motor	57AC	8063451	EAMM-A-L27-57AC
With stepper motor and gear unit			
EMMS-ST-42-... EMGA-40-P-G...-SST-42	40G	☆ 557974	EAMM-A-L27-40G
EMMS-ST-57-... EMGA-60-P-G...-SST-57	60G	8063455	EAMM-A-L27-60G
With third-party gear unit			
Third-party gear unit	50GA	8063454	EAMM-A-L27-50GA
Third-party gear unit	60G	8063455	EAMM-A-L27-60G

1) The input torque must not exceed the max. permissible transferable torque of the axial kit.



Product range overview

Permissible axis/motor combinations with toothed belt axis EGC-TB

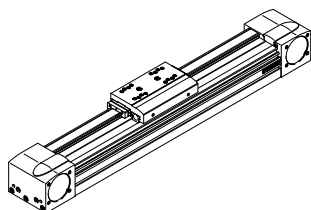

Table of interfaces for third-party motors

→ from page 64

Technical data for axial kits

→ from page 69

Motor/gear unit ¹⁾	Motor interface	Axial kit	
		Part no.	Type
EGC-70-...-TB			
With servo motor			
Third-party motor	55A	3683331	EAMM-A-L38-55A
Third-party motor	58AA	8063456	EAMM-A-L38-58AA
EMMT-AS-60-..., EMME-AS-60-..., EMMB-AS-60-..., third-party motor	60P	★ 2037246	EAMM-A-L38-60P
Third-party motor	60PA	8063459	EAMM-A-L38-60PA
Third-party motor	60R	8107703	EAMM-A-L38-60R
Third-party motor	60RB	8063460	EAMM-A-L38-60RB
Third-party motor	70A	557979	EAMM-A-L38-70A
Third-party motor	70AA, 70AB	8063461	EAMM-A-L38-70AA
Third-party motor	84AA	8063464	EAMM-A-L38-84AA
Third-party motor	88A	8063463	EAMM-A-L38-88A
With servo motor and gear unit			
EMME-AS-40-... EMGA-40-P-G...-EAS-40	40G	8063465	EAMM-A-L38-40G
EMMT-AS-60-..., EMME-AS-60-... EMGA-60-P-G...-EAS-60	60H	1456610	EAMM-A-L38-60H
With servo motor and right-angle gear unit			
EMMT-AS-60-..., EMME-AS-60-..., EMMB-AS-60-... EMGA-60-A-G...-60P	60H	1456610	EAMM-A-L38-60H
With stepper motor			
EMMS-ST-57-... Third-party motor	57A	★ 560679	EAMM-A-L38-57A
Third-party motor	57AA	8063457	EAMM-A-L38-57AA
Third-party motor	60AA	8107702	EAMM-A-L38-60AA
EMMS-ST-87-... Third-party motor	87A	★ 560680	EAMM-A-L38-87A
With stepper motor and gear unit			
EMMS-ST-42-... EMGA-40-P-G...-SST-42	40G	8063465	EAMM-A-L38-40G
EMMS-ST-57-... EMGA-60-P-G...-SST-57	60G	★ 557978	EAMM-A-L38-60G
With third-party gear unit			
Third-party gear unit	40G	8063465	EAMM-A-L38-40G
Third-party gear unit	50GA	8063466	EAMM-A-L38-50GA
Third-party gear unit	56GA	8063467	EAMM-A-L38-56GA
Third-party gear unit	68GA	8063469	EAMM-A-L38-68GA
Third-party gear unit	70GA	8063468	EAMM-A-L38-70GA
Third-party gear unit	72GA	8063470	EAMM-A-L38-72GA

1) The input torque must not exceed the max. permissible transferable torque of the axial kit.

Festo Core Range



Generally ready for shipping ex works in 24 hours

Generally ready for shipping ex works in 5 days

Product range overview

Permissible axis/motor combinations with toothed belt axis EGC-TB

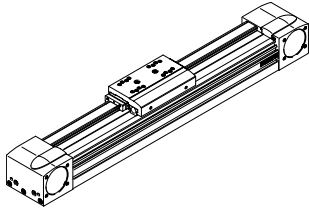

Table of interfaces for third-party motors

→ from page 64

Technical data for axial kits

→ from page 69

Motor/gear unit ¹⁾	Motor interface	Axial kit	
		Part no.	Type
EGC-80-...-TB			
With servo motor			
Third-party motor	55A	8063471	EAMM-A-L48-55A
Third-party motor	60PA	8063472	EAMM-A-L48-60PA
Third-party motor	70A	557982	EAMM-A-L48-70A
Third-party motor	70AA, 70AB	8063473	EAMM-A-L48-70AA
EMMT-AS-80-..., EMME-AS-80-..., EMMB-AS-80-..., third-party motor	80P	8164277	EAMM-A-L48-80P-G2
Third-party motor	80PB	8123168	EAMM-A-L48-80PB
Third-party motor	82AA	8063475	EAMM-A-L48-82AA
Third-party motor	84AA	8063479	EAMM-A-L48-84AA
Third-party motor	88A	8063476	EAMM-A-L48-88A
Third-party motor	90R	8063477	EAMM-A-L48-90R
Third-party motor	92RA	8063478	EAMM-A-L48-92RA
EMMT-AS-100-..., EMME-AS-100-..., third-party motor	100A	8164278	EAMM-A-L48-100A-G2
With servo motor and gear unit			
EMME-AS-40-... EMGA-40-P-G...-EAS-40	40G	8063480	EAMM-A-L48-40G
EMMT-AS-60-..., EMME-AS-60-... EMGA-60-P-G...-EAS-60	60H	1456611	EAMM-A-L48-60H
EMMT-AS-80-..., EMME-AS-80-... EMGA-80-P-G...-EAS-80	80G	8063485	EAMM-A-L48-80G
EMMT-AS-100-..., EMME-AS-100-... EMGA-80-P-G...-SAS-100	80G	8063485	EAMM-A-L48-80G
With servo motor and right-angle gear unit			
EMME-AS-40-..., EMMB-AS-40-... EMGA-40-A-G...-40P	40G	8063480	EAMM-A-L48-40G
EMMT-AS-60-..., EMME-AS-60-..., EMMB-AS-60-... EMGA-60-A-G...-60P	60H	1456611	EAMM-A-L48-60H
EMMT-AS-80-..., EMME-AS-80-..., EMMB-AS-80-... EMGA-80-A-G...-80P	80G	8063485	EAMM-A-L48-80G
EMMT-AS-100-..., EMME-AS-100-... EMGA-80-A-G...-100A	80G	8063485	EAMM-A-L48-80G

1) The input torque must not exceed the max. permissible transferable torque of the axial kit.

Product range overview

Permissible axis/motor combinations with toothed belt axis EGC-TB

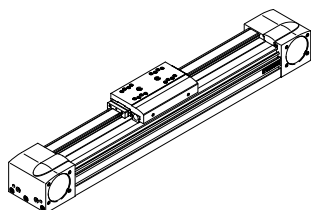

Table of interfaces for third-party motors

→ from page 64

Technical data for axial kits

→ from page 69

Motor/gear unit ¹⁾ Type	Motor interface	Axial kit	
		Part no.	Type
With stepper motor			
EMMS-ST-87-...	87A	★ 560683	EAMM-A-L48-87A
With stepper motor and gear unit			
EMMS-ST-57-... EMGA-60-P-G...-SST-57	60G	★ 557983	EAMM-A-L48-60G
EMMS-ST-87-... EMGA-80-P-G...-SST-87	80G	8063485	EAMM-A-L48-80G
With third-party gear unit			
Third-party gear unit	40G	8063480	EAMM-A-L48-40G
Third-party gear unit	50GA	8063481	EAMM-A-L48-50GA
Third-party gear unit	56GA	8063482	EAMM-A-L48-56GA
Third-party gear unit	68GA	8063486	EAMM-A-L48-68GA
Third-party gear unit	70GA	8063483	EAMM-A-L48-70GA
Third-party gear unit	72GA	8063487	EAMM-A-L48-72GA
Third-party gear unit	75GA	8063484	EAMM-A-L48-75GA
Third-party gear unit	80G	8063485	EAMM-A-L48-80G
Third-party gear unit	90GA	8063489	EAMM-A-L48-90GA
Third-party gear unit	90GB	8063488	EAMM-A-L48-90GB
Third-party gear unit	120GA	8063490	EAMM-A-L48-120GA

1) The input torque must not exceed the max. permissible transferable torque of the axial kit.

Festo Core Range



Generally ready for shipping ex works in 24 hours

Generally ready for shipping ex works in 5 days

Product range overview

Permissible axis/motor combinations with toothed belt axis EGC-TB

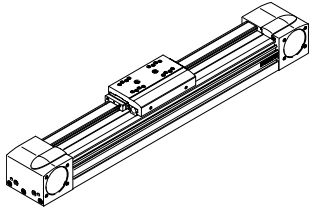

Table of interfaces for third-party motors

→ from page 64

Technical data for axial kits

→ from page 69

Motor/gear unit ¹⁾	Motor interface	Axial kit	
		Part no.	Type
EGC-120-...-TB			
With servo motor			
Third-party motor	84AA	8063493	EAMM-A-L62-84AA
Third-party motor	88A	8063492	EAMM-A-L62-88A
EMMT-AS-100-..., EMME-AS-100-..., third-party motor	100A	8164276	EAMM-A-L62-100A-G2
Third-party motor	108AA	8063494	EAMM-A-L62-108AA
EMMT-AS-150-...	150A	8157270	EAMM-A-L62-150A
With servo motor and gear unit			
EMMT-AS-60-..., EMME-AS-60-... EMGA-60-P-G...-EAS-60	60H	8063498	EAMM-A-L62-60H
EMMT-AS-80-..., EMME-AS-80-... EMGA-80-P-G...-EAS-80	80G	★ 557989	EAMM-A-L62-80G
EMMT-AS-100-..., EMME-AS-100-... EMGA-80-P-G...-SAS-100	80G	★ 557989	EAMM-A-L62-80G
With servo motor and right-angle gear unit			
EMMT-AS-60-..., EMME-AS-60-..., EMMB-AS-60-... EMGA-60-A-G...-60P	60H	8063498	EAMM-A-L62-60H
EMMT-AS-80-..., EMME-AS-80-..., EMMB-AS-80-... EMGA-80-A-G...-80P	80G	★ 557989	EAMM-A-L62-80G
EMMT-AS-100-..., EMME-AS-100-... EMGA-80-A-G...-100A	80G	★ 557989	EAMM-A-L62-80G
With stepper motor and gear unit			
EMMS-ST-87-... EMGA-80-P-G...-SST-87	80G	★ 557989	EAMM-A-L62-80G
With third-party gear unit			
Third-party gear unit	56GA	8063497	EAMM-A-L62-56GA
Third-party gear unit	60H	8063498	EAMM-A-L62-60H
Third-party gear unit	68GA	8063502	EAMM-A-L62-68GA
Third-party gear unit	70GA	8063499	EAMM-A-L62-70GA
Third-party gear unit	72GA	8063503	EAMM-A-L62-72GA
Third-party gear unit	75GA	8063500	EAMM-A-L62-75GA
Third-party gear unit	80G	★ 557989	EAMM-A-L62-80G
Third-party gear unit	90GA	8063505	EAMM-A-L62-90GA
Third-party gear unit	90GB	8063504	EAMM-A-L62-90GB
Third-party gear unit	115GA	8063506	EAMM-A-L62-115GA
Third-party gear unit	120G	8063507	EAMM-A-L62-120G
Third-party gear unit	120GA	8063508	EAMM-A-L62-120GA
Third-party gear unit	120GB	8063509	EAMM-A-L62-120GB
Third-party gear unit	120GC	8063510	EAMM-A-L62-120GC

1) The input torque must not exceed the max. permissible transferable torque of the axial kit.



Product range overview

Permissible axis/motor combinations with toothed belt axis EGC-TB

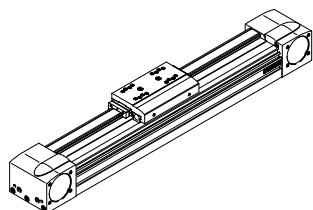

Table of interfaces for third-party motors

→ from page 64

Technical data for axial kits

→ from page 69

Motor/gear unit ¹⁾ Type	Motor interface	Axial kit	
		Part no.	Type
EGC-185-...-TB			
With servo motor			
EMMT-AS-150-...	150A	8157280	EAMM-A-L95-150A-G2
EMMT-AS-190-...	190B	8157282	EAMM-A-L95-190B-G2
With servo motor and gear unit			
EMMT-AS-80-..., EMME-AS-80-... EMGA-80-P-G...-EAS-80	80G	3660191	EAMM-A-L95-80G-G2
EMMT-AS-100-..., EMME-AS-100-... EMGA-80-P-G...-SAS-100	80G	3660191	EAMM-A-L95-80G-G2
EMMT-AS-100-..., EMME-AS-100-... EMGA-120-P-G...-SAS-100	120G	★ 3659941	EAMM-A-L95-120G-G2
EMMT-AS-150-... EMGA-120-P-G...-SAS-140	120G	★ 3659941	EAMM-A-L95-120G-G2
With servo motor and right-angle gear unit			
EMMT-AS-80-..., EMME-AS-80-..., EMMB-AS-80-... EMGA-80-A-G...-80P	80G	3660191	EAMM-A-L95-80G-G2
EMMT-AS-100-..., EMME-AS-100-... EMGA-80-A-G...-100A	80G	3660191	EAMM-A-L95-80G-G2
With third-party gear unit			
Third-party gear unit	68GA	8063524	EAMM-A-L95-68GA
Third-party gear unit	72GA	8063525	EAMM-A-L95-72GA
Third-party gear unit	75GA	8063522	EAMM-A-L95-75GA
Third-party gear unit	80G	3660191	EAMM-A-L95-80G-G2
Third-party gear unit	90GA	8063526	EAMM-A-L95-90GA
Third-party gear unit	115GA	8063527	EAMM-A-L95-115GA
Third-party gear unit	120G	★ 3659941	EAMM-A-L95-120G-G2
Third-party gear unit	120GA	8063529	EAMM-A-L95-120GA
Third-party gear unit	120GB	8063530	EAMM-A-L95-120GB
Third-party gear unit	120GC	8063531	EAMM-A-L95-120GC
Third-party gear unit	160G	8063532	EAMM-A-L95-160G

1) The input torque must not exceed the max. permissible transferable torque of the axial kit.

Festo Core Range



Generally ready for shipping ex works in 24 hours

Generally ready for shipping ex works in 5 days

Product range overview

Permissible axis/motor combinations with ball screw (spindle) axis EGC-BS

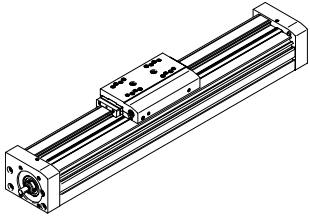

Table of interfaces for third-party motors

→ from page 64

Technical data for axial kits

→ from page 69

Motor/gear unit ¹⁾ Type	Motor interface	Axial kit	
		Part no.	Type
EGC-70-...-BS			
With servo motor			
EMME-AS-40-..., EMMB-AS-40-...	40P	★ 3637972	EAMM-A-S38-40P-G2
Third-party motor	40A	3637971	EAMM-A-S38-40A-G2
Third-party motor	55A	3637967	EAMM-A-S38-55A-G2
Third-party motor	58AA	8105927	EAMM-A-S38-58AA
EMMT-AS-60-..., EMME-AS-60-..., EMMB-AS-60-..., third-party motor	60P	★ 3637958	EAMM-A-S38-60P-G2
Third-party motor	60R	8105923	EAMM-A-S38-60R
Third-party motor	60RA	8105924	EAMM-A-S38-60RA
With servo motor and gear unit			
EMME-AS-40-... EMGA-40-P-G...-EAS-40	40G	1456647	EAMM-A-S38-40G-G2
With servo motor and right-angle gear unit			
EMME-AS-40-..., EMMB-AS-40-... EMGA-40-A-G...-40P	40G	1456647	EAMM-A-S38-40G-G2
With stepper motor			
EMMS-ST-42-..., third-party motor	42A	★ 3637965	EAMM-A-S38-42A-G2
EMMS-ST-57-...	57A	★ 3637956	EAMM-A-S38-57A-G2
Third-party motor	60AA	8105926	EAMM-A-S38-60AA
With stepper motor and gear unit			
EMMS-ST-42-... EMGA-40-P-G...-SST-42	40G	1456647	EAMM-A-S38-40G-G2
With third-party gear unit			
Third-party gear unit	40G	1456647	EAMM-A-S38-40G-G2
Third-party gear unit	50GA	8105922	EAMM-A-S38-50GA

1) The input torque must not exceed the max. permissible transferable torque of the axial kit.



Product range overview

Permissible axis/motor combinations with ball screw (spindle) axis EGC-BS

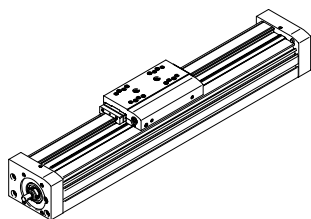

Table of interfaces for third-party motors

→ from page 64

Technical data for axial kits

→ from page 69

Motor/gear unit ¹⁾ Type	Motor interface	Axial kit	
		Part no.	Type
EGC-80-...-BS			
With servo motor			
Third-party motor	55A	3637961	EAMM-A-S48-55A-G2
Third-party motor	58AA	8105933	EAMM-A-S48-58AA
EMMT-AS-60-..., EMME-AS-60-..., EMMB-AS-60-..., third-party motor	60P	★ 3637964	EAMM-A-S48-60P-G2
Third-party motor	60R	8105939	EAMM-A-S48-60R
Third-party motor	60RA	8105941	EAMM-A-S48-60RA
Third-party motor	70A	3637957	EAMM-A-S48-70A-G2
Third-party motor	70AA, 70AB	8105942	EAMM-A-S48-70AA
With servo motor and gear unit			
EMME-AS-40-... EMGA-40-P-G...-EAS-40	40G	1456650	EAMM-A-S48-40G-G2
EMMT-AS-60-..., EMME-AS-60-... EMGA-60-P-G...-EAS-60	60H	1456652	EAMM-A-S48-60H-G2
With servo motor and right-angle gear unit			
EMME-AS-40-..., EMMB-AS-40-... EMGA-40-A-G...-40P	40G	1456650	EAMM-A-S48-40G-G2
EMMT-AS-60-..., EMME-AS-60-..., EMMB-AS-60-... EMGA-60-A-G...-60P	60H	1456652	EAMM-A-S48-60H-G2
With stepper motor			
EMMS-ST-57-... Third-party motor	57A	★ 3637963	EAMM-A-S48-57A-G2
EMMS-ST-87-...	60AA	8105935	EAMM-A-S48-60AA
	87A	★ 3637962	EAMM-A-S48-87A-G2
With stepper motor and gear unit			
EMMS-ST-42-... EMGA-40-P-G...-SST-42	40G	1456650	EAMM-A-S48-40G-G2
EMMS-ST-57-... EMGA-60-P-G...-SST-57	60G	2256701	EAMM-A-S48-60G-G2
With third-party gear unit			
Third-party gear unit	40G	1456650	EAMM-A-S48-40G-G2
Third-party gear unit	50GA	8105930	EAMM-A-S48-50GA
Third-party gear unit	60H	1456652	EAMM-A-S48-60H-G2

1) The input torque must not exceed the max. permissible transferable torque of the axial kit.

Festo Core Range



Generally ready for shipping ex works in 24 hours

Generally ready for shipping ex works in 5 days

Product range overview

Permissible axis/motor combinations with ball screw (spindle) axis EGC-BS

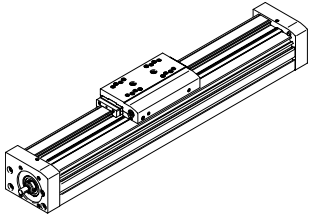

Table of interfaces for third-party motors

→ from page 64

Technical data for axial kits

→ from page 69

Motor/gear unit ¹⁾ Type	Motor interface	Axial kit	
		Part no.	Type
EGC-120-...-BS			
With servo motor			
Third-party motor	70A	3637959	EAMM-A-S62-70A-G2
EMMT-AS-80-..., EMME-AS-80-..., EMMB-AS-80-..., third-party motor	80P	★ 3637970	EAMM-A-S62-80P-G2
Third-party motor	80PB, 80R	8110208	EAMM-A-S62-80PB
Third-party motor	82AA	8110211	EAMM-A-S62-82AA
Third-party motor	84AA	8110226	EAMM-A-S62-84AA
EMMT-AS-100-..., EMME-AS-100-..., third-party motor	100A	★ 3637960	EAMM-A-S62-100A-G2
EMMT-AS-150	150A	8157272	EAMM-A-S62-150A-G2
With servo motor and gear unit			
EMMT-AS-60-..., EMME-AS-60-... EMGA-60-P-G...-EAS-60	60H	1456654	EAMM-A-S62-60H-G2
EMMT-AS-80-..., EMME-AS-80-... EMGA-80-P-G...-EAS-80	80G	1972530	EAMM-A-S62-80G-G2
EMMT-AS-100-..., EMME-AS-100-... EMGA-80-P-G...-SAS-100	80G	1972530	EAMM-A-S62-80G-G2
With servo motor and right-angle gear unit			
EMMT-AS-60-..., EMME-AS-60-..., EMMB-AS-60-... EMGA-60-A-G...-60P	60H	1456654	EAMM-A-S62-60H-G2
EMMT-AS-80-..., EMME-AS-80-..., EMMB-AS-80-... EMGA-80-A-G...-80P	80G	1972530	EAMM-A-S62-80G-G2
EMMT-AS-100-..., EMME-AS-100-... EMGA-80-A-G...-100A	80G	1972530	EAMM-A-S62-80G-G2

1) The input torque must not exceed the max. permissible transferable torque of the axial kit.



Product range overview

Permissible axis/motor combinations with ball screw (spindle) axis EGC-BS

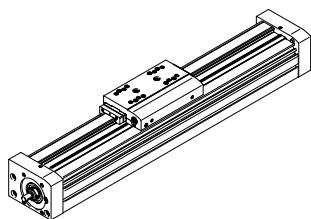

Table of interfaces for third-party motors

→ from page 64

Technical data for axial kits

→ from page 69

Motor/gear unit ¹⁾ Type	Motor interface	Axial kit	
		Part no.	Type
EGC-120-...-BS			
With stepper motor			
EMMS-ST-87-...	87A	★ 3637966	EAMM-A-S62-87A-G2
With stepper motor and gear unit			
EMMS-ST-57-... EMGA-60-P-G-...-SST-57	60G	2297649	EAMM-A-S62-60G-G2
EMMS-ST-87-... EMGA-80-P-G-...-SST-87	80G	1972530	EAMM-A-S62-80G-G2
With third-party gear unit			
Third-party gear unit	60H	1456654	EAMM-A-S62-60H-G2
Third-party gear unit	70GA	8110082	EAMM-A-S62-70GA
Third-party gear unit	80G	1972530	EAMM-A-S62-80G-G2
EGC-185-...-BS			
With servo motor			
Third-party motor	84AA	8107720	EAMM-A-S95-84AA
EMMT-AS-100-..., EMME-AS-100-..., third-party motor	100A	3637955	EAMM-A-S95-100A-G2
EMMT-AS-150	150A	8157279	EAMM-A-S95-150A-G2
With third-party gear unit			
Third-party gear unit	90GA	8110066	EAMM-A-S95-90GA

1) The input torque must not exceed the max. permissible transferable torque of the axial kit.

Festo Core Range



Generally ready for shipping ex works in 24 hours

Generally ready for shipping ex works in 5 days

Product range overview

Permissible axis/motor combinations with toothed belt axis ELGD-TB-...

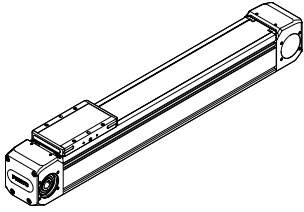

Table of interfaces for third-party motors

→ from page 64

Technical data for axial kits

→ from page 69

Motor/gear unit ¹⁾ Type	Motor interface	Axial kit	
		Part no.	Type
ELGD-TB-...-60			
With servo motor			
Third-party motor	60PA	8063590	EAMM-A-N48-60PA
Third-party motor	70AA	8063591	EAMM-A-N48-70AA
EMMT-AS-80-..., EMME-AS-80-..., EMMB-AS-80-..., third-party motor	80P	8063592	EAMM-A-N48-80P
Third-party motor	80PB	8107714	EAMM-A-N48-80PB
Third-party motor	84AA	8063594	EAMM-A-N48-84AA
Third-party motor	88A	8063593	EAMM-A-N48-88A
EMMT-AS-100-..., EMME-AS-100-..., third-party motor	100A	1201894	EAMM-A-N48-100A
With servo motor and gear unit			
EMMT-AS-60-..., EMME-AS-60-... EMGA-60-P-G...-EAS-60	60H	1456618	EAMM-A-N48-60H
EMMT-AS-80-..., EMME-AS-80-... EMGA-80-P-G...-EAS-80	80G	★ 1258793	EAMM-A-N48-80G
EMMT-AS-100-..., EMME-AS-100-... EMGA-80-P-G...-SAS-100	80G	★ 1258793	EAMM-A-N48-80G
With servo motor and right-angle gear unit			
EMMT-AS-60-..., EMME-AS-60-..., EMMB-AS-60-... EMGA-60-A-G...-60P	60H	1456618	EAMM-A-N48-60H
EMMT-AS-80-..., EMME-AS-80-..., EMMB-AS-80-... EMGA-80-A-G...-80P	80G	★ 1258793	EAMM-A-N48-80G
EMMT-AS-100-..., EMME-AS-100-... EMGA-80-A-G...-100A	80G	★ 1258793	EAMM-A-N48-80G

1) The input torque must not exceed the max. permissible transferable torque of the axial kit.



Product range overview

Permissible axis/motor combinations with toothed belt axis ELGD-TB-...

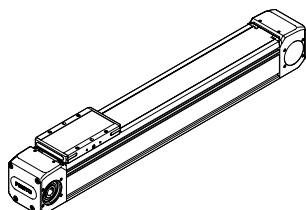

Table of interfaces for third-party motors

→ from page 64

Technical data for axial kits

→ from page 69

Motor/gear unit ¹⁾ Type	Motor interface	Axial kit	
		Part no.	Type
ELGD-TB-...-60			
With stepper motor and gear unit			
EMMS-ST-57-... EMGA-60-P-G...-SST-57	60G	★ 1972527	EAMM-A-N48-60G
EMMS-ST-87-... EMGA-80-P-G...-SST-87	80G	★ 1258793	EAMM-A-N48-80G
With third-party gear unit			
Third-party gear unit	50GA	8063595	EAMM-A-N48-50GA
Third-party gear unit	56GA	8063596	EAMM-A-N48-56GA
Third-party gear unit	60H	1456618	EAMM-A-N48-60H
Third-party gear unit	68GA	8063600	EAMM-A-N48-68GA
Third-party gear unit	70GA	8063597	EAMM-A-N48-70GA
Third-party gear unit	72GA	8063601	EAMM-A-N48-72GA
Third-party gear unit	75GA	8063598	EAMM-A-N48-75GA
Third-party gear unit	80G	★ 1258793	EAMM-A-N48-80G
Third-party gear unit	90GA	8063603	EAMM-A-N48-90GA
Third-party gear unit	90GB	8063602	EAMM-A-N48-90GB
Third-party gear unit	120GA	8063605	EAMM-A-N48-120GA

1) The input torque must not exceed the max. permissible transferable torque of the axial kit.

Festo Core Range



Generally ready for shipping ex works in 24 hours

Generally ready for shipping ex works in 5 days

Product range overview

Permissible axis/motor combinations with toothed belt axis ELGD-TB-...

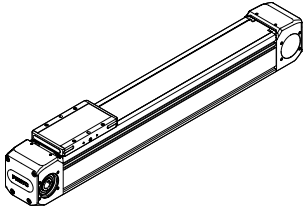

Table of interfaces for third-party motors

→ from page 64

Technical data for axial kits

→ from page 69

Motor/gear unit ¹⁾ Type	Motor interface	Axial kit	
		Part no.	Type
ELGD-TB-...-80			
With servo motor			
Third-party motor	55A	8063471	EAMM-A-L48-55A
Third-party motor	60PA	8063472	EAMM-A-L48-60PA
Third-party motor	70A	557982	EAMM-A-L48-70A
Third-party motor	70AA, 70AB	8063473	EAMM-A-L48-70AA
EMMT-AS-80-..., EMME-AS-80-..., EMMB-AS-80-..., third-party motor	80P	8164277	EAMM-A-L48-80P-G2
Third-party motor	80PB	8123168	EAMM-A-L48-80PB
Third-party motor	82AA	8063475	EAMM-A-L48-82AA
Third-party motor	84AA	8063479	EAMM-A-L48-84AA
Third-party motor	88A	8063476	EAMM-A-L48-88A
Third-party motor	90R	8063477	EAMM-A-L48-90R
Third-party motor	92RA	8063478	EAMM-A-L48-92RA
With servo motor and gear unit			
EMME-AS-40-... EMGA-40-P-G...-EAS-40	40G	8063480	EAMM-A-L48-40G
EMMT-AS-60-..., EMME-AS-60-... EMGA-60-P-G...-EAS-60	60H	1456611	EAMM-A-L48-60H
EMMT-AS-80-..., EMME-AS-80-... EMGA-80-P-G...-EAS-80	80G	8063485	EAMM-A-L48-80G
EMMT-AS-100-..., EMME-AS-100-... EMGA-80-P-G...-SAS-100	80G	8063485	EAMM-A-L48-80G
With servo motor and right-angle gear unit			
EMME-AS-40-..., EMMB-AS-40-... EMGA-40-A-G...-40P	40G	8063480	EAMM-A-L48-40G
EMMT-AS-60-..., EMME-AS-60-..., EMMB-AS-60-... EMGA-60-A-G...-60P	60H	1456611	EAMM-A-L48-60H
EMMT-AS-80-..., EMME-AS-80-..., EMMB-AS-80-... EMGA-80-A-G...-80P	80G	8063485	EAMM-A-L48-80G
EMMT-AS-100-..., EMME-AS-100-... EMGA-80-A-G...-100A	80G	8063485	EAMM-A-L48-80G

1) The input torque must not exceed the max. permissible transferable torque of the axial kit.

Product range overview

Permissible axis/motor combinations with toothed belt axis ELGD-TB-...

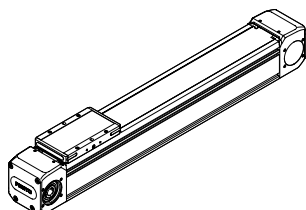

Table of interfaces for third-party motors

→ from page 64

Technical data for axial kits

→ from page 69

Motor/gear unit ¹⁾ Type	Motor interface	Axial kit	
		Part no.	Type
ELGD-TB-...-80			
With stepper motor			
EMMS-ST-87-...	87A	★ 560683	EAMM-A-L48-87A
With stepper motor and gear unit			
EMMS-ST-57-... EMGA-60-P-G...-SST-57	60G	★ 557983	EAMM-A-L48-60G
EMMS-ST-87-... EMGA-80-P-G...-SST-87	80G	8063485	EAMM-A-L48-80G
With third-party gear unit			
Third-party gear unit	40G	8063480	EAMM-A-L48-40G
Third-party gear unit	50GA	8063481	EAMM-A-L48-50GA
Third-party gear unit	56GA	8063482	EAMM-A-L48-56GA
Third-party gear unit	68GA	8063486	EAMM-A-L48-68GA
Third-party gear unit	70GA	8063483	EAMM-A-L48-70GA
Third-party gear unit	72GA	8063487	EAMM-A-L48-72GA
Third-party gear unit	75GA	8063484	EAMM-A-L48-75GA
Third-party gear unit	80G	8063485	EAMM-A-L48-80G
Third-party gear unit	90GA	8063489	EAMM-A-L48-90GA
Third-party gear unit	90GB	8063488	EAMM-A-L48-90GB
Third-party gear unit	120GA	8063490	EAMM-A-L48-120GA

1) The input torque must not exceed the max. permissible transferable torque of the axial kit.

Festo Core Range



Generally ready for shipping ex works in 24 hours

Generally ready for shipping ex works in 5 days

Product range overview

Permissible axis/motor combinations with toothed belt axis ELGD-TB-...

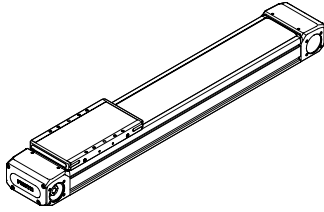

Table of interfaces for third-party motors

→ from page 64

Technical data for axial kits

→ from page 69

Motor/gear unit ¹⁾	Motor interface	Axial kit	
		Part no.	Type
ELGD-TB-...-WD-100			
With servo motor			
Third-party motor	55A	3683331	EAMM-A-L38-55A
Third-party motor	58AA	8063456	EAMM-A-L38-58AA
EMMT-AS-60-..., EMME-AS-60-..., EMMB-AS-60-..., third-party motor	60P	★ 2037246	EAMM-A-L38-60P
Third-party motor	60PA	8063459	EAMM-A-L38-60PA
Third-party motor	60R	8107703	EAMM-A-L38-60R
Third-party motor	60RB	8063460	EAMM-A-L38-60RB
Third-party motor	70A	557979	EAMM-A-L38-70A
Third-party motor	70AA, 70AB	8063461	EAMM-A-L38-70AA
Third-party motor	84AA	8063464	EAMM-A-L38-84AA
Third-party motor	88A	8063463	EAMM-A-L38-88A
With servo motor and gear unit			
EMME-AS-40-... EMGA-40-P-G-...-EAS-40	40G	8063465	EAMM-A-L38-40G
EMMT-AS-60-..., EMME-AS-60-... EMGA-60-P-G-...-EAS-60	60H	1456610	EAMM-A-L38-60H
With servo motor and right-angle gear unit			
EMMT-AS-60-..., EMME-AS-60-..., EMMB-AS-60-... EMGA-60-A-G-...-60P	60H	1456610	EAMM-A-L38-60H
With stepper motor			
EMMS-ST-57-... Third-party motor	57A	★ 560679	EAMM-A-L38-57A
Third-party motor	57AA	8063457	EAMM-A-L38-57AA
Third-party motor	60AA	8107702	EAMM-A-L38-60AA
EMMS-ST-87-... Third-party motor	87A	★ 560680	EAMM-A-L38-87A
With stepper motor and gear unit			
EMMS-ST-42-... EMGA-40-P-G-...-SST-42	40G	8063465	EAMM-A-L38-40G
EMMS-ST-57-... EMGA-60-P-G-...-SST-57	60G	★ 557978	EAMM-A-L38-60G
With third-party gear unit			
Third-party gear unit	40G	8063465	EAMM-A-L38-40G
Third-party gear unit	50GA	8063466	EAMM-A-L38-50GA
Third-party gear unit	56GA	8063467	EAMM-A-L38-56GA
Third-party gear unit	68GA	8063469	EAMM-A-L38-68GA
Third-party gear unit	70GA	8063468	EAMM-A-L38-70GA
Third-party gear unit	72GA	8063470	EAMM-A-L38-72GA

1) The input torque must not exceed the max. permissible transferable torque of the axial kit.



Product range overview

Permissible axis/motor combinations with ball screw (spindle) axis ELGD-BS-...

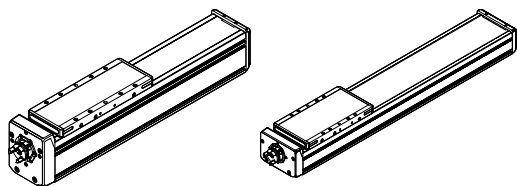

Table of interfaces for third-party motors

→ from page 64

Technical data for axial kits

→ from page 69

Motor ¹⁾ Type	Motor interface	Axial kit	
		Part no.	Type
ELGD-BS-...-60/ ELGD-BS-...-WD-100			
With servo motor			
Third-party motor	55A	8082614	EAMM-A-T42-55A
Third-party motor	58AA	8094935	EAMM-A-T42-58AA
EMMT-AS-60-..., EMME-AS-60-..., EMMB-AS-60-..., third-party motor	60P, 60PA	4133487	EAMM-A-T42-60P
Third-party motor	60R	8093289	EAMM-A-T42-60R
Third-party motor	60RA	8092264	EAMM-A-T42-60RA
EMMT-AS-80-..., EMME-AS-80-..., EMMB-AS-80-..., third-party motor	80P	4623788	EAMM-A-T42-80P
With stepper motor			
EMMS-ST-57-...	57A	4327034	EAMM-A-T42-57A
Third-party motor	60AA	8092255	EAMM-A-T42-60AA
Third-party motor	60AB	8094949	EAMM-A-T42-60AB
EMMS-ST-87-...	87A	4610008	EAMM-A-T42-87A

1) The input torque must not exceed the max. permissible transferable torque of the axial kit.

Motor ¹⁾ Type	Motor interface	Axial kit	
		Part no.	Type
ELGD-BS-...-80			
With servo motor			
EMMT-AS-60-..., EMME-AS-60-..., EMMB-AS-60-..., third-party motor	60P, 60PA	4824833	EAMM-A-T46-60P
Third-party motor	60R	8126174	EAMM-A-T46-60R
Third-party motor	60RA	8126175	EAMM-A-T46-60RA
Third-party motor	70A	8092674	EAMM-A-T46-70A
Third-party motor	70AA, 70AB	8096057	EAMM-A-T46-70AA
EMMT-AS-80-..., EMME-AS-80-..., EMMB-AS-80-..., third-party motor	80P	4624170	EAMM-A-T46-80P
Third-party motor	80PA, 80RA	8091047	EAMM-A-T46-80PA
Third-party motor	80PB, 80R	8096175	EAMM-A-T46-80PB
EMMT-AS-100-..., EMME-AS-100-..., third-party motor	100A	4624227	EAMM-A-T46-100A
With stepper motor			
Third-party motor	85AA	8096186	EAMM-A-T46-85AA
EMMS-ST-57-...	57A	8169409	EAMM-A-T46-57A
EMMS-ST-87-...	87A	4048771	EAMM-A-T46-87A

1) The input torque must not exceed the max. permissible transferable torque of the axial kit.

Festo Core Range



Generally ready for shipping ex works in 24 hours

Generally ready for shipping ex works in 5 days

Product range overview

Permissible axis/motor combinations with toothed belt axis ELGA-TB-...

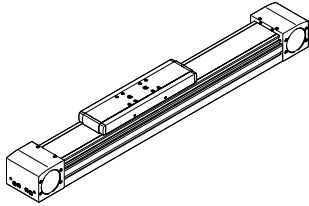

Table of interfaces for third-party motors

→ from page 64

Technical data for axial kits

→ from page 69

Motor/gear unit ¹⁾ Type	Motor interface	Axial kit	
		Part no.	Type
ELGA-TB-...-70			
With servo motor			
Third-party motor	60PA	8063574	EAMM-A-N38-60PA
Third-party gear unit	60RA	8063575	EAMM-A-N38-60RA
Third-party motor	70A	1202331	EAMM-A-N38-70A
Third-party motor	70AA, 70AB	8063576	EAMM-A-N38-70AA
Third-party motor	88A	8063579	EAMM-A-N38-88A
Third-party motor	90R	8063580	EAMM-A-N38-90R
Third-party motor	92RA	8063581	EAMM-A-N38-92RA
With servo motor and gear unit			
EMME-AS-40-... EMGA-40-P-G-...-EAS-40	40G	8063583	EAMM-A-N38-40G
EMMT-AS-60-..., EMME-AS-60-... EMGA-60-P-G-...-EAS-60	60H	1456616	EAMM-A-N38-60H
With servo motor and right-angle gear unit			
EMME-AS-40-..., EMMB-AS-40-... EMGA-40-A-G-...-40P	40G	8063583	EAMM-A-N38-40G
EMMT-AS-60-..., EMME-AS-60-..., EMMB-AS-60-... EMGA-60-A-G-...-60P	60H	1456616	EAMM-A-N38-60H
With stepper motor			
EMMS-ST-87-...	87A	★ 3324111	EAMM-A-N38-87A
With stepper motor and gear unit			
EMMS-ST-57-... EMGA-60-P-G-...-SST-57	60G	★ 1202253	EAMM-A-N38-60G
With third-party gear unit			
Third-party gear unit	40G	8063583	EAMM-A-N38-40G
Third-party gear unit	50GA	8063584	EAMM-A-N38-50GA
Third-party gear unit	56GA	8063585	EAMM-A-N38-56GA
Third-party gear unit	60H	1456616	EAMM-A-N38-60H
Third-party gear unit	68GA	8063587	EAMM-A-N38-68GA
Third-party gear unit	70GA	8063586	EAMM-A-N38-70GA
Third-party gear unit	72GA	8063588	EAMM-A-N38-72GA

1) The input torque must not exceed the max. permissible transferable torque of the axial kit.



Product range overview

Permissible axis/motor combinations with toothed belt axis ELGA-TB-...

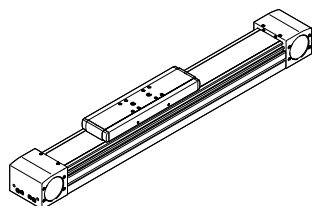

Table of interfaces for third-party motors

→ from page 64

Technical data for axial kits

→ from page 69

Motor/gear unit ¹⁾ Type	Motor interface	Axial kit	
		Part no.	Type
ELGA-TB-...-80			
With servo motor			
Third-party motor	60PA	8063590	EAMM-A-N48-60PA
Third-party motor	70AA	8063591	EAMM-A-N48-70AA
EMMT-AS-80-..., EMME-AS-80-..., EMMB-AS-80-..., third-party motor	80P	8063592	EAMM-A-N48-80P
Third-party motor	80PB	8107714	EAMM-A-N48-80PB
Third-party motor	84AA	8063594	EAMM-A-N48-84AA
Third-party motor	88A	8063593	EAMM-A-N48-88A
EMMT-AS-100-..., EMME-AS-100-..., third-party motor	100A	1201894	EAMM-A-N48-100A
With servo motor and gear unit			
EMMT-AS-60-..., EMME-AS-60-... EMGA-60-P-G...-EAS-60	60H	1456618	EAMM-A-N48-60H
EMMT-AS-80-..., EMME-AS-80-... EMGA-80-P-G...-EAS-80	80G	★ 1258793	EAMM-A-N48-80G
EMMT-AS-100-..., EMME-AS-100-... EMGA-80-P-G...-SAS-100	80G	★ 1258793	EAMM-A-N48-80G
With servo motor and right-angle gear unit			
EMMT-AS-60-..., EMME-AS-60-..., EMMB-AS-60-... EMGA-60-A-G...-60P	60H	1456618	EAMM-A-N48-60H
EMMT-AS-80-..., EMME-AS-80-..., EMMB-AS-80-... EMGA-80-A-G...-80P	80G	★ 1258793	EAMM-A-N48-80G
EMMT-AS-100-..., EMME-AS-100-... EMGA-80-A-G...-100A	80G	★ 1258793	EAMM-A-N48-80G

1) The input torque must not exceed the max. permissible transferable torque of the axial kit.

Festo Core Range



Generally ready for shipping ex works in 24 hours

Generally ready for shipping ex works in 5 days

Product range overview

Permissible axis/motor combinations with toothed belt axis ELGA-TB-...

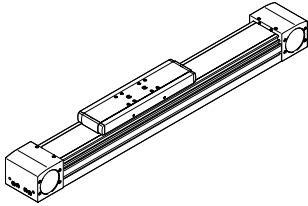

Table of interfaces for third-party motors

→ from page 64

Technical data for axial kits

→ from page 69

Motor/gear unit ¹⁾ Type	Motor interface	Axial kit	
		Part no.	Type
ELGA-TB-...-80			
With stepper motor and gear unit			
EMMS-ST-57-... EMGA-60-P-G...-SST-57	60G	★ 1972527	EAMM-A-N48-60G
EMMS-ST-87-... EMGA-80-P-G...-SST-87	80G	★ 1258793	EAMM-A-N48-80G
With third-party gear unit			
Third-party gear unit	50GA	8063595	EAMM-A-N48-50GA
Third-party gear unit	56GA	8063596	EAMM-A-N48-56GA
Third-party gear unit	60H	1456618	EAMM-A-N48-60H
Third-party gear unit	68GA	8063600	EAMM-A-N48-68GA
Third-party gear unit	70GA	8063597	EAMM-A-N48-70GA
Third-party gear unit	72GA	8063601	EAMM-A-N48-72GA
Third-party gear unit	75GA	8063598	EAMM-A-N48-75GA
Third-party gear unit	80G	★ 1258793	EAMM-A-N48-80G
Third-party gear unit	90GA	8063603	EAMM-A-N48-90GA
Third-party gear unit	90GB	8063602	EAMM-A-N48-90GB
Third-party gear unit	120GA	8063605	EAMM-A-N48-120GA

1) The input torque must not exceed the max. permissible transferable torque of the axial kit.



Product range overview

Permissible axis/motor combinations with toothed belt axis ELGA-TB-...

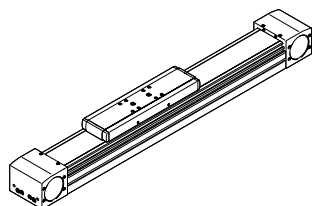

Table of interfaces for third-party motors

→ from page 64

Technical data for axial kits

→ from page 69

Motor/gear unit ¹⁾ Type	Motor interface	Axial kit	
		Part no.	Type
ELGA-TB-...-120			
With servo motor			
Third-party motor	84AA	8063606	EAMM-A-N80-84AA
Third-party motor	100A	8063607	EAMM-A-N80-100A
EMMT-AS-150-...	150A	8157277	EAMM-A-N80-150A
With servo motor and gear unit			
EMMT-AS-80-..., EMME-AS-80-... EMGA-80-P-G...-EAS-80	80G	★ 2372096	EAMM-A-N80-80G
EMMT-AS-100-..., EMME-AS-100-... EMGA-80-P-G...-SAS-100	80G	★ 2372096	EAMM-A-N80-80G
EMMT-AS-100-..., EMME-AS-100-... EMGA-120-P-G...-SAS-100	120G	★ 1201695	EAMM-A-N80-120G
EMMT-AS-150-... EMGA-120-P-G...-SAS-140	120G	★ 1201695	EAMM-A-N80-120G
With servo motor and right-angle gear unit			
EMMT-AS-80-..., EMME-AS-80-..., EMMB-AS-80-... EMGA-80-A-G...-80P	80G	★ 2372096	EAMM-A-N80-80G
EMMT-AS-100-..., EMME-AS-100-... EMGA-80-A-G...-100A	80G	★ 2372096	EAMM-A-N80-80G
With stepper motor and gear unit			
EMMS-ST-87-... EMGA-80-P-G...-SST-87	80G	★ 2372096	EAMM-A-N80-80G
With third-party gear unit			
Third-party gear unit	68GA	8063611	EAMM-A-N80-68GA
Third-party gear unit	70GA	8063608	EAMM-A-N80-70GA
Third-party gear unit	72GA	8063612	EAMM-A-N80-72GA
Third-party gear unit	75GA	8063609	EAMM-A-N80-75GA
Third-party gear unit	80G	★ 2372096	EAMM-A-N80-80G
Third-party gear unit	90GA	8063614	EAMM-A-N80-90GA
Third-party gear unit	90GB	8063613	EAMM-A-N80-90GB
Third-party gear unit	115GA	8063615	EAMM-A-N80-115GA
Third-party gear unit	120GA	8063617	EAMM-A-N80-120GA
Third-party gear unit	120GB	8063618	EAMM-A-N80-120GB
Third-party gear unit	120GC	8063619	EAMM-A-N80-120GC

1) The input torque must not exceed the max. permissible transferable torque of the axial kit.

Festo Core Range



Generally ready for shipping ex works in 24 hours

Generally ready for shipping ex works in 5 days

Product range overview

Permissible axis/motor combinations with toothed belt axis ELGA-TB-...

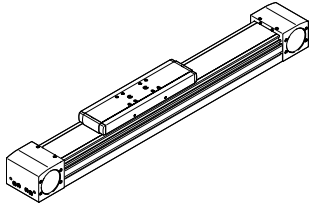

Table of interfaces for third-party motors

→ from page 64

Technical data for axial kits

→ from page 69

Motor/gear unit ¹⁾ Type	Motor interface	Axial kit	
		Part no.	Type
ELGA-TB-...-150			
With servo motor			
EMMT-AS-150-...	150A	8157280	EAMM-A-L95-150A-G2
EMMT-AS-190-...	190B	8157282	EAMM-A-L95-190B-G2
With servo motor and gear unit			
EMMT-AS-80-..., EMME-AS-80-... EMGA-80-P-G...-EAS-80	80G	3660191	EAMM-A-L95-80G-G2
EMMT-AS-100-..., EMME-AS-100-... EMGA-80-P-G...-SAS-100	80G	3660191	EAMM-A-L95-80G-G2
EMMT-AS-100-..., EMME-AS-100-... EMGA-120-P-G...-SAS-100	120G	★ 3659941	EAMM-A-L95-120G-G2
EMMT-AS-150-... EMGA-120-P-G...-SAS-140	120G	★ 3659941	EAMM-A-L95-120G-G2
With servo motor and right-angle gear unit			
EMMT-AS-80-..., EMME-AS-80-..., EMMB-AS-80-... EMGA-80-A-G...-80P	80G	3660191	EAMM-A-L95-80G-G2
EMMT-AS-100-..., EMME-AS-100-... EMGA-80-A-G...-100A	80G	3660191	EAMM-A-L95-80G-G2
With third-party gear unit			
Third-party gear unit	68GA	8063524	EAMM-A-L95-68GA
Third-party gear unit	72GA	8063525	EAMM-A-L95-72GA
Third-party gear unit	75GA	8063522	EAMM-A-L95-75GA
Third-party gear unit	80G	3660191	EAMM-A-L95-80G-G2
Third-party gear unit	90GA	8063526	EAMM-A-L95-90GA
Third-party gear unit	115GA	8063527	EAMM-A-L95-115GA
Third-party gear unit	120G	★ 3659941	EAMM-A-L95-120G-G2
Third-party gear unit	120GA	8063529	EAMM-A-L95-120GA
Third-party gear unit	120GB	8063530	EAMM-A-L95-120GB
Third-party gear unit	120GC	8063531	EAMM-A-L95-120GC
Third-party gear unit	160G	8063532	EAMM-A-L95-160G

1) The input torque must not exceed the max. permissible transferable torque of the axial kit.



Product range overview

Permissible axis/motor combinations with ball screw (spindle) axis ELGA-BS-...

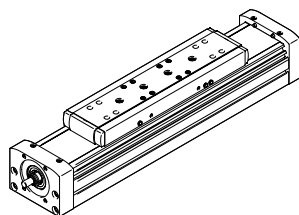

Table of interfaces for third-party motors

→ from page 64

Technical data for axial kits

→ from page 69

Motor/gear unit ¹⁾ Type	Motor interface	Axial kit	
		Part no.	Type
ELGA-BS-...-70			
With servo motor			
EMME-AS-40-..., EMMB-AS-40-...	40P	★ 3637972	EAMM-A-S38-40P-G2
Third-party motor	40A	3637971	EAMM-A-S38-40A-G2
Third-party motor	55A	3637967	EAMM-A-S38-55A-G2
Third-party motor	58AA	8105927	EAMM-A-S38-58AA
EMMT-AS-60-..., EMME-AS-60-..., EMMB-AS-60-..., third-party motor	60P	★ 3637958	EAMM-A-S38-60P-G2
Third-party motor	60R	8105923	EAMM-A-S38-60R
Third-party motor	60RA	8105924	EAMM-A-S38-60RA
With servo motor and gear unit			
EMME-AS-40-... EMGA-40-P-G...-EAS-40	40G	1456647	EAMM-A-S38-40G-G2
With servo motor and right-angle gear unit			
EMME-AS-40-..., EMMB-AS-40-... EMGA-40-A-G...-40P	40G	1456647	EAMM-A-S38-40G-G2
With stepper motor			
EMMS-ST-42-..., third-party motor	42A	★ 3637965	EAMM-A-S38-42A-G2
EMMS-ST-57-...	57A	★ 3637956	EAMM-A-S38-57A-G2
Third-party motor	60AA	8105926	EAMM-A-S38-60AA
With stepper motor and gear unit			
EMMS-ST-42-... EMGA-40-P-G...-SST-42	40G	1456647	EAMM-A-S38-40G-G2
With third-party gear unit			
Third-party gear unit	40G	1456647	EAMM-A-S38-40G-G2
Third-party gear unit	50GA	8105922	EAMM-A-S38-50GA

1) The input torque must not exceed the max. permissible transferable torque of the axial kit.

Festo Core Range



Generally ready for shipping ex works in 24 hours

Generally ready for shipping ex works in 5 days

Product range overview

Permissible axis/motor combinations with ball screw (spindle) axis ELGA-BS-...

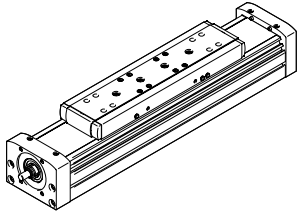

Table of interfaces for third-party motors

→ from page 64

Technical data for axial kits

→ from page 69

Motor/gear unit ¹⁾ Type	Motor interface	Axial kit	
		Part no.	Type
ELGA-BS-...-80			
With servo motor			
Third-party motor	55A	3637961	EAMM-A-S48-55A-G2
Third-party motor	58AA	8105933	EAMM-A-S48-58AA
EMMT-AS-60-..., EMME-AS-60-..., EMMB-AS-60-..., third-party motor	60P	★ 3637964	EAMM-A-S48-60P-G2
Third-party motor	60R	8105939	EAMM-A-S48-60R
Third-party motor	60RA	8105941	EAMM-A-S48-60RA
Third-party motor	70A	3637957	EAMM-A-S48-70A-G2
Third-party motor	70AA, 70AB	8105942	EAMM-A-S48-70AA
With servo motor and gear unit			
EMME-AS-40-... EMGA-40-P-G-...-EAS-40	40G	1456650	EAMM-A-S48-40G-G2
EMMT-AS-60-..., EMME-AS-60-... EMGA-60-P-G-...-EAS-60	60H	1456652	EAMM-A-S48-60H-G2
With servo motor and right-angle gear unit			
EMME-AS-40-..., EMMB-AS-40-... EMGA-40-A-G-...-40P	40G	1456650	EAMM-A-S48-40G-G2
EMMT-AS-60-..., EMME-AS-60-..., EMMB-AS-60-... EMGA-60-A-G-...-60P	60H	1456652	EAMM-A-S48-60H-G2
With stepper motor			
EMMS-ST-57-...	57A	★ 3637963	EAMM-A-S48-57A-G2
Third-party motor	60AA	8105935	EAMM-A-S48-60AA
EMMS-ST-87-...	87A	★ 3637962	EAMM-A-S48-87A-G2
With stepper motor and gear unit			
EMMS-ST-42-... EMGA-40-P-G-...-SST-42	40G	1456650	EAMM-A-S48-40G-G2
EMMS-ST-57-... EMGA-60-P-G-...-SST-57	60G	2256701	EAMM-A-S48-60G-G2
With third-party gear unit			
Third-party gear unit	40G	1456650	EAMM-A-S48-40G-G2
Third-party gear unit	50GA	8105930	EAMM-A-S48-50GA
Third-party gear unit	60H	1456652	EAMM-A-S48-60H-G2

1) The input torque must not exceed the max. permissible transferable torque of the axial kit.



Product range overview

Permissible axis/motor combinations with ball screw (spindle) axis ELGA-BS-...

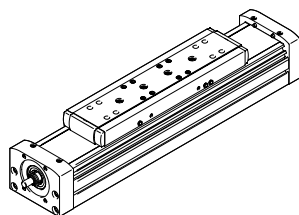

Table of interfaces for third-party motors

→ from page 64

Technical data for axial kits

→ from page 69

Motor/gear unit ¹⁾ Type	Motor interface	Axial kit	
		Part no.	Type
ELGA-BS-...-120			
With servo motor			
Third-party motor	70A	3637959	EAMM-A-S62-70A-G2
EMMT-AS-80-..., EMME-AS-80-..., EMMB-AS-80-..., third-party motor	80P	★ 3637970	EAMM-A-S62-80P-G2
Third-party motor	80PB, 80R	8110208	EAMM-A-S62-80PB
Third-party motor	82AA	8110211	EAMM-A-S62-82AA
Third-party motor	84AA	8110226	EAMM-A-S62-84AA
EMMT-AS-100-..., EMME-AS-100-..., third-party motor	100A	★ 3637960	EAMM-A-S62-100A-G2
EMMT-AS-150-...	150A	8157272	EAMM-A-S62-150A-G2
With servo motor and gear unit			
EMMT-AS-60-..., EMME-AS-60-... EMGA-60-P-G...-EAS-60	60H	1456654	EAMM-A-S62-60H-G2
EMMT-AS-80-..., EMME-AS-80-... EMGA-80-P-G...-EAS-80	80G	1972530	EAMM-A-S62-80G-G2
EMMT-AS-100-..., EMME-AS-100-... EMGA-80-P-G...-SAS-100	80G	1972530	EAMM-A-S62-80G-G2
With servo motor and right-angle gear unit			
EMMT-AS-60-..., EMME-AS-60-..., EMMB-AS-60-... EMGA-60-A-G...-60P	60H	1456654	EAMM-A-S62-60H-G2
EMMT-AS-80-..., EMME-AS-80-..., EMMB-AS-80-... EMGA-80-A-G...-80P	80G	1972530	EAMM-A-S62-80G-G2
EMMT-AS-100-..., EMME-AS-100-... EMGA-80-A-G...-100A	80G	1972530	EAMM-A-S62-80G-G2

1) The input torque must not exceed the max. permissible transferable torque of the axial kit.

Festo Core Range



Generally ready for shipping ex works in 24 hours

Generally ready for shipping ex works in 5 days

Product range overview

Permissible axis/motor combinations with ball screw (spindle) axis ELGA-BS-...

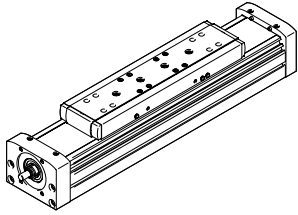

Table of interfaces for third-party motors

→ from page 64

Technical data for axial kits

→ from page 69

Motor/gear unit ¹⁾ Type	Motor interface	Axial kit	
		Part no.	Type
ELGA-BS-...-120			
With stepper motor			
EMMS-ST-87-...	87A	★ 3637966	EAMM-A-S62-87A-G2
With stepper motor and gear unit			
EMMS-ST-57-... EMGA-60-P-G-...-SST-57	60G	2297649	EAMM-A-S62-60G-G2
EMMS-ST-87-... EMGA-80-P-G-...-SST-87	80G	1972530	EAMM-A-S62-80G-G2
With third-party gear unit			
Third-party gear unit	60H	1456654	EAMM-A-S62-60H-G2
Third-party gear unit	70GA	8110082	EAMM-A-S62-70GA
Third-party gear unit	80G	1972530	EAMM-A-S62-80G-G2
ELGA-BS-...-150			
With servo motor			
Third-party motor	84AA	8107720	EAMM-A-S95-84AA
EMMT-AS-100-..., EMME-AS-100-..., third-party motor	100A	3637955	EAMM-A-S95-100A-G2
EMMT-AS-150-...	150A	8157279	EAMM-A-S95-150A-G2
With third-party gear unit			
Third-party gear unit	90GA	8110066	EAMM-A-S95-90GA

1) The input torque must not exceed the max. permissible transferable torque of the axial kit.



Product range overview

Permissible axis/motor combinations with ball screw (spindle) axis ELGT-BS-...

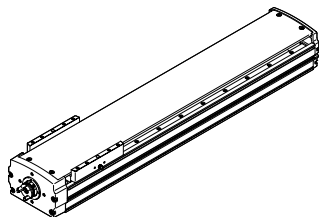

Table of interfaces for third-party motors

→ from page 64

Technical data for axial kits

→ from page 69

Motor ¹⁾ Type	Motor interface	Axial kit	
		Part no.	Type
ELGT-BS-...-90/-120/-160			
With servo motor			
EMMT-AS-60-..., EMME-AS-60-..., EMMB-AS-60-..., third-party motor	60P, 60PA	4824833	EAMM-A-T46-60P
Third-party motor	60R	8126174	EAMM-A-T46-60R
Third-party motor	60RA	8126174	EAMM-A-T46-60RA
Third-party motor	70A	8092674	EAMM-A-T46-70A
Third-party motor	70AA, 70AB	8096057	EAMM-A-T46-70AA
EMMT-AS-80-..., EMME-AS-80-..., EMMB-AS-80-..., third-party motor	80P	4624170	EAMM-A-T46-80P
Third-party motor	80PA, 80RA	8091047	EAMM-A-T46-80PA
Third-party motor	80PB, 80R	8096175	EAMM-A-T46-80PB
EMMT-AS-100-..., EMME-AS-100-..., third-party motor	100A	4624227	EAMM-A-T46-100A
With stepper motor			
Third-party motor	85AA	8096186	EAMM-A-T46-85AA
EMMS-ST-57-...	57A	8169409	EAMM-A-T46-57A
EMMS-ST-87-...	87A	4048771	EAMM-A-T46-87A

1) The input torque must not exceed the max. permissible transferable torque of the axial kit.

Product range overview

Permissible axis/motor combinations with toothed belt axis ELGC-TB-...

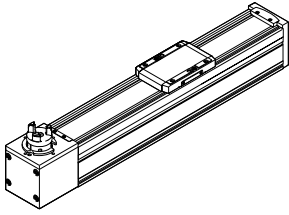

Table of interfaces for third-party motors

→ from page 64

Technical data for axial kits

→ from page 69

Motor ¹⁾ Type	Motor interface	Axial kit	
		Part no.	Type
ELGC-TB-...-45			
With servo motor			
Third-party motor	38AA	8093023	EAMM-A-V32-38AA
EMME-AS-40-..., EMMB-AS-40-...	40P	4595742	EAMM-A-V32-40P
Third-party motor	40R	8087090	EAMM-A-V32-40R
Third-party motor	40RA	8094180	EAMM-A-V32-40RA
Third-party motor	58AA	8098982	EAMM-A-V32-58AA
EMMT-AS-60-..., EMME-AS-60-..., EMMB-AS-60-..., third-party motor	60P	4608750	EAMM-A-V32-60P
Third-party motor	60PA	8091053	EAMM-A-V32-60PA
Third-party motor	60RA	8093041	EAMM-A-V32-60RA
With stepper motor			
EMMS-ST-42-..., third-party motor	42A	4281142	EAMM-A-V32-42A
Third-party motor	42AB	8094200	EAMM-A-V32-42AB
EMMS-ST-57-...	57A	4597016	EAMM-A-V32-57A
Third-party motor	60AA	8092271	EAMM-A-V32-60AA
ELGC-TB-...-60			
With servo motor			
Third-party motor	55A	8082614	EAMM-A-T42-55A
Third-party motor	58AA	8094935	EAMM-A-T42-58AA
EMMT-AS-60-..., EMME-AS-60-..., EMMB-AS-60-..., third-party motor	60P, 60PA	4133487	EAMM-A-T42-60P
Third-party motor	60R	8093289	EAMM-A-T42-60R
Third-party motor	60RA	8092264	EAMM-A-T42-60RA
EMMT-AS-80-..., EMME-AS-80-..., EMMB-AS-80-...	80P	4623788	EAMM-A-T42-80P
With stepper motor			
EMMS-ST-57-...	57A	4327034	EAMM-A-T42-57A
Third-party motor	60AA	8092255	EAMM-A-T42-60AA
Third-party motor	60AB	8094949	EAMM-A-T42-60AB
EMMS-ST-87-...	87A	4610008	EAMM-A-T42-87A

1) The input torque must not exceed the max. permissible transferable torque of the axial kit.

Product range overview

Permissible axis/motor combinations with toothed belt axis ELGC-TB-...

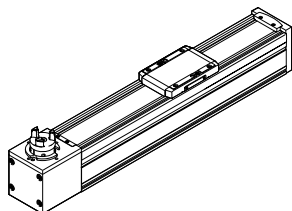

Table of interfaces for third-party motors

→ from page 64

Technical data for axial kits

→ from page 69

Motor ¹⁾ Type	Motor interface	Axial kit	
		Part no.	Type
ELGC-TB-...-80			
With servo motor			
EMMT-AS-60-..., EMME-AS-60-..., EMMB-AS-60-..., third-party motor	60P, 60PA	4824833	EAMM-A-T46-60P
Third-party motor	60R	8126174	EAMM-A-T46-60R
Third-party motor	60RA	8126174	EAMM-A-T46-60RA
Third-party motor	70A	8092674	EAMM-A-T46-70A
Third-party motor	70AA, 70AB	8096057	EAMM-A-T46-70AA
EMMT-AS-80-..., EMME-AS-80-..., EMMB-AS-80-..., third-party motor	80P	4624170	EAMM-A-T46-80P
Third-party motor	80PA, 80RA	8091047	EAMM-A-T46-80PA
Third-party motor	80PB, 80R	8096175	EAMM-A-T46-80PB
EMMT-AS-100-..., EMME-AS-100-..., third-party motor	100A	4624227	EAMM-A-T46-100A
With stepper motor			
Third-party motor	85AA	8096186	EAMM-A-T46-85AA
EMMS-ST-57-...	57A	8169409	EAMM-A-T46-57A
EMMS-ST-87-...	87A	4048771	EAMM-A-T46-87A

1) The input torque must not exceed the max. permissible transferable torque of the axial kit.

Product range overview

Permissible axis/motor combinations with ball screw (spindle) axis ELGC-BS-...

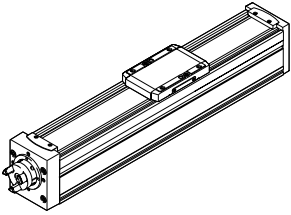

Table of interfaces for third-party motors

→ from page 64

Technical data for axial kits

→ from page 69

Motor ¹⁾ Type	Motor interface	Axial kit	
		Part no.	Type
ELGC-BS-...-32			
With servo motor			
Third-party motor	38AA	8093162	EAMM-A-V25-38AA
EMME-AS-40-..., EMMB-AS-40-..., third-party motor	40P	4491059	EAMM-A-V25-40P
Third-party motor	40R	8087062	EAMM-A-V25-40R
Third-party motor	40RA	8094100	EAMM-A-V25-40RA
With stepper motor			
Third-party motor	35A	8093255	EAMM-A-V25-35A
EMMS-ST-42-..., third-party motor	42A	4582608	EAMM-A-V25-42A
Third-party motor	42AB	8094108	EAMM-A-V25-42AB
ELGC-BS-...-45			
With servo motor			
Third-party motor	38AA	8093023	EAMM-A-V32-38AA
EMME-AS-40-..., EMMB-AS-40-...	40P	4595742	EAMM-A-V32-40P
Third-party motor	40R	8087090	EAMM-A-V32-40R
Third-party motor	40RA	8094180	EAMM-A-V32-40RA
Third-party motor	58AA	8098982	EAMM-A-V32-58AA
EMMT-AS-60-..., EMME-AS-60-..., EMMB-AS-60-..., third-party motor	60P	4608750	EAMM-A-V32-60P
Third-party motor	60PA	8091053	EAMM-A-V32-60PA
Third-party motor	60RA	8093041	EAMM-A-V32-60RA
With stepper motor			
EMMS-ST-42-..., third-party motor	42A	4281142	EAMM-A-V32-42A
Third-party motor	42AB	8094200	EAMM-A-V32-42AB
EMMS-ST-57-...	57A	4597016	EAMM-A-V32-57A
Third-party motor	60AA	8092271	EAMM-A-V32-60AA
ELGC-BS-...-60			
With servo motor			
Third-party motor	55A	8082614	EAMM-A-T42-55A
Third-party motor	58AA	8094935	EAMM-A-T42-58AA
EMMT-AS-60-..., EMME-AS-60-..., EMMB-AS-60-..., third-party motor	60P, 60PA	4133487	EAMM-A-T42-60P
Third-party motor	60R	8093289	EAMM-A-T42-60R
Third-party motor	60RA	8092264	EAMM-A-T42-60RA
EMMT-AS-80-..., EMME-AS-80-..., EMMB-AS-80-..., third-party motor	80P	4623788	EAMM-A-T42-80P
With stepper motor			
EMMS-ST-57-...	57A	4327034	EAMM-A-T42-57A
Third-party motor	60AA	8092255	EAMM-A-T42-60AA
Third-party motor	60AB	8094949	EAMM-A-T42-60AB
EMMS-ST-87-...	87A	4610008	EAMM-A-T42-87A

1) The input torque must not exceed the max. permissible transferable torque of the axial kit.

Product range overview

Permissible axis/motor combinations with ball screw (spindle) axis ELGC-BS-...

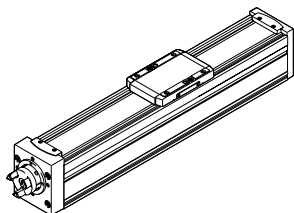

Table of interfaces for third-party motors

→ from page 64

Technical data for axial kits

→ from page 69

Motor ¹⁾ Type	Motor interface	Axial kit	
		Part no.	Type
ELGC-BS-...-80			
With servo motor			
EMMT-AS-60-..., EMME-AS-60-..., EMMB-AS-60-..., third-party motor	60P, 60PA	4824833	EAMM-A-T46-60P
Third-party motor	60R	8126174	EAMM-A-T46-60R
Third-party motor	60RA	8126174	EAMM-A-T46-60RA
Third-party motor	70A	8092674	EAMM-A-T46-70A
Third-party motor	70AA, 70AB	8096057	EAMM-A-T46-70AA
EMMT-AS-80-..., EMME-AS-80-..., EMMB-AS-80-..., third-party motor	80P	4624170	EAMM-A-T46-80P
Third-party motor	80PA, 80RA	8091047	EAMM-A-T46-80PA
Third-party motor	80PB, 80R	8096175	EAMM-A-T46-80PB
EMMT-AS-100-..., EMME-AS-100-..., third-party motor	100A	4624227	EAMM-A-T46-100A
With stepper motor			
Third-party motor	85AA	8096186	EAMM-A-T46-85AA
EMMS-ST-57-...	57A	8169409	EAMM-A-T46-57A
EMMS-ST-87-...	87A	4048771	EAMM-A-T46-87A

1) The input torque must not exceed the max. permissible transferable torque of the axial kit.

Product range overview

Permissible axis/motor combinations with toothed belt axis EGC-HD-TB

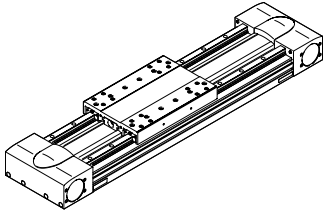

Table of interfaces for third-party motors

→ from page 64

Technical data for axial kits

→ from page 69

Motor/gear unit ¹⁾ Type	Motor interface	Axial kit	
		Part no.	Type
EGC-HD-125-...-TB			
With servo motor			
Third-party motor	55A	8063533	EAMM-A-M43-55A
Third-party motor	70A	8063534	EAMM-A-M43-70A
Third-party motor	70AA, 70AB	8063535	EAMM-A-M43-70AA
Third-party motor	90R	8063537	EAMM-A-M43-90R
Third-party motor	92RA	8063538	EAMM-A-M43-92RA
With servo motor and gear unit			
EMME-AS-40-... EMGA-40-P-G...-EAS-40	40G	8063539	EAMM-A-M43-40G
EMMT-AS-60-..., EMME-AS-60-... EMGA-60-P-G...-EAS-60	60H	1456612	EAMM-A-M43-60H
With servo motor and right-angle gear unit			
EMME-AS-40-..., EMMB-AS-40-... EMGA-40-A-G...-40P	40P	8063539	EAMM-A-M43-40P
EMMT-AS-60-..., EMME-AS-60-..., EMMB-AS-60-... EMGA-60-A-G...-60P	60H	1456612	EAMM-A-M43-60H
With stepper motor and gear unit			
EMMS-ST-57-... EMGA-60-P-G...-SST-57	60G	1190076	EAMM-A-M43-60G
With third-party gear unit			
Third-party gear unit	40G	8063539	EAMM-A-M43-40G
Third-party gear unit	50GA	8063540	EAMM-A-M43-50GA
Third-party gear unit	56GA	8063541	EAMM-A-M43-56GA
Third-party gear unit	60H	1456612	EAMM-A-M43-60H
Third-party gear unit	68GA	8063544	EAMM-A-M43-68GA
Third-party gear unit	70GA	8063542	EAMM-A-M43-70GA
Third-party gear unit	72GA	8063545	EAMM-A-M43-72GA

1) The input torque must not exceed the max. permissible transferable torque of the axial kit.

Product range overview

Permissible axis/motor combinations with toothed belt axis EGC-HD-TB

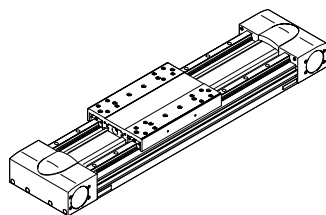

Table of interfaces for third-party motors

→ from page 64

Technical data for axial kits

→ from page 69

Motor/gear unit ¹⁾	Motor interface	Axial kit	
		Part no.	Type
EGC-HD-160-...-TB			
With servo motor			
Third-party motor	84AA	8063548	EAMM-A-M48-84AA
Third-party motor	88A	8063547	EAMM-A-M48-88A
With servo motor and gear unit			
EMME-AS-40-... EMGA-40-P-G...-EAS-40	40G	8063549	EAMM-A-M48-40G
EMMT-AS-60-..., EMME-AS-60-... EMGA-60-P-G...-EAS-60	60H	1456614	EAMM-A-M48-60H
EMMT-AS-80-..., EMME-AS-80-... EMGA-80-P-G...-EAS-80	80G	1190421	EAMM-A-M48-80G
EMMT-AS-100-..., EMME-AS-100-... EMGA-80-P-G...-SAS-100	80G	1190421	EAMM-A-M48-80G
With servo motor and right-angle gear unit			
EMME-AS-40-..., EMME-AS-40-... EMGA-40-A-G...-40P	40P	8063549	EAMM-A-M48-40P
EMMT-AS-60-..., EMME-AS-60-..., EMME-AS-60-... EMGA-60-A-G...-60P	60H	1456614	EAMM-A-M48-60H
EMMT-AS-80-..., EMME-AS-80-..., EMME-AS-80-... EMGA-80-A-G...-80P	80G	1190421	EAMM-A-M48-80G
EMMT-AS-100-..., EMME-AS-100-... EMGA-80-A-G...-100A	80G	1190421	EAMM-A-M48-80G
With stepper motor and gear unit			
EMMS-ST-57-... EMGA-60-P-G...-SST-57	60G	8063552	EAMM-A-M48-60G
EMMS-ST-87-... EMGA-80-P-G...-SST-87	80G	1190421	EAMM-A-M48-80G
With third-party gear unit			
Third-party gear unit	40G	8063549	EAMM-A-M48-40G
Third-party gear unit	50GA	8063550	EAMM-A-M48-50GA
Third-party gear unit	56GA	8063551	EAMM-A-M48-56GA
Third-party gear unit	60H	1456614	EAMM-A-M48-60H
Third-party gear unit	68GA	8063556	EAMM-A-M48-68GA
Third-party gear unit	70GA	8063553	EAMM-A-M48-70GA
Third-party gear unit	72GA	8063557	EAMM-A-M48-72GA
Third-party gear unit	75GA	8063554	EAMM-A-M48-75GA
Third-party gear unit	90GA	8063559	EAMM-A-M48-90GA
Third-party gear unit	90GB	8063558	EAMM-A-M48-90GB
Third-party gear unit	120GA	8063561	EAMM-A-M48-120GA

1) The input torque must not exceed the max. permissible transferable torque of the axial kit.

Product range overview

Permissible axis/motor combinations with toothed belt axis EGC-HD-TB

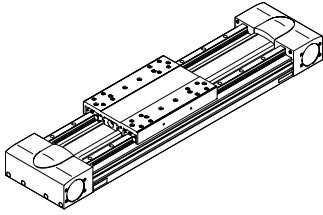

Table of interfaces for third-party motors

→ from page 64

Technical data for axial kits

→ from page 69

Motor/gear unit ¹⁾ Type	Motor interface	Axial kit	
		Part no.	Type
EGC-HD-220-...-TB			
With servo motor			
Third-party motor	84AA	8063563	EAMM-A-M80-84AA
With servo motor and gear unit			
EMMT-AS-80-..., EMME-AS-80-... EMGA-80-P-G...-EAS-80	80G	8063565	EAMM-A-M80-80G
EMMT-AS-100-..., EMME-AS-100-... EMGA-80-P-G...-SAS-100	80G	8063565	EAMM-A-M80-80G
EMMT-AS-100-..., EMME-AS-100-... EMGA-120-P-G...-SAS-100	120G	1190774	EAMM-A-M80-120G
EMMT-AS-150-... EMGA-120-P-G...-SAS-140	120G	1190774	EAMM-A-M80-120G
With third-party gear unit			
Third-party gear unit	68GA	8063566	EAMM-A-M80-68GA
Third-party gear unit	75GA	8063564	EAMM-A-M80-75GA
Third-party gear unit	80G	8063565	EAMM-A-M80-80G
Third-party gear unit	90GA	8063568	EAMM-A-M80-90GA
Third-party gear unit	90GB	8063567	EAMM-A-M80-90GB
Third-party gear unit	115GA	8063569	EAMM-A-M80-115GA
Third-party gear unit	120G	1190774	EAMM-A-M80-120G
Third-party gear unit	120GA	8063571	EAMM-A-M80-120GA
Third-party gear unit	120GB	8063572	EAMM-A-M80-120GB
Third-party gear unit	120GC	8063573	EAMM-A-M80-120GC

1) The input torque must not exceed the max. permissible transferable torque of the axial kit.

Product range overview

Permissible axis/motor combinations with ball screw (spindle) axis EGC-HD-BS

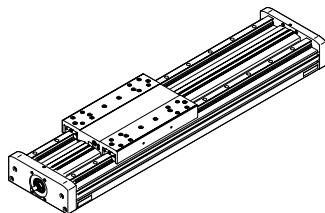

Table of interfaces for third-party motors

→ from page 64

Technical data for axial kits

→ from page 69

Motor/gear unit ¹⁾	Motor interface	Axial kit	
		Part no.	Type
EGC-HD-125-...-BS			
With servo motor			
EMME-AS-40-..., EMMB-AS-40-...	40P	★ 3637972	EAMM-A-S38-40P-G2
Third-party motor	40A	3637971	EAMM-A-S38-40A-G2
Third-party motor	55A	3637967	EAMM-A-S38-55A-G2
Third-party motor	58AA	8105927	EAMM-A-S38-58AA
EMMT-AS-60-..., EMME-AS-60-..., EMMB-AS-60-..., third-party motor	60P	★ 3637958	EAMM-A-S38-60P-G2
Third-party motor	60R	8105923	EAMM-A-S38-60R
Third-party motor	60RA	8105924	EAMM-A-S38-60RA
With servo motor and gear unit			
EMME-AS-40-... EMGA-40-P-G...-EAS-40	40G	1456647	EAMM-A-S38-40G-G2
With servo motor and right-angle gear unit			
EMME-AS-40-..., EMMB-AS-40-... EMGA-40-A-G...-40P	40G	1456647	EAMM-A-S38-40G-G2
With stepper motor			
EMMS-ST-42-..., third-party motor	42A	★ 3637965	EAMM-A-S38-42A-G2
EMMS-ST-57-...	57A	★ 3637956	EAMM-A-S38-57A-G2
Third-party motor	60AA	8105926	EAMM-A-S38-60AA
With stepper motor and gear unit			
EMMS-ST-42-... EMGA-40-P-G...-SST-42	40G	1456647	EAMM-A-S38-40G-G2
With third-party gear unit			
Third-party gear unit	40G	1456647	EAMM-A-S38-40G-G2
Third-party gear unit	50GA	8105922	EAMM-A-S38-50GA

1) The input torque must not exceed the max. permissible transferable torque of the axial kit.

Festo Core Range



Generally ready for shipping ex works in 24 hours

Generally ready for shipping ex works in 5 days

Product range overview

Permissible axis/motor combinations with ball screw (spindle) axis EGC-HD-BS

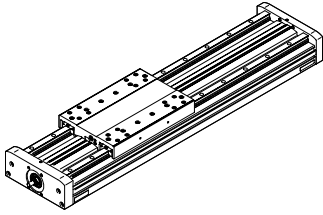

Table of interfaces for third-party motors

→ from page 64

Technical data for axial kits

→ from page 69

Motor/gear unit ¹⁾ Type	Motor interface	Axial kit	
		Part no.	Type
EGC-HD-160-...-BS			
With servo motor			
Third-party motor	55A	3637961	EAMM-A-S48-55A-G2
Third-party motor	58AA	8105933	EAMM-A-S48-58AA
EMMT-AS-60-..., EMME-AS-60-..., EMMB-AS-60-..., third-party motor	60P	★ 3637964	EAMM-A-S48-60P-G2
Third-party motor	60R	8105939	EAMM-A-S48-60R
Third-party motor	60RA	8105941	EAMM-A-S48-60RA
Third-party motor	70A	3637957	EAMM-A-S48-70A-G2
Third-party motor	70AA, 70AB	8105942	EAMM-A-S48-70AA
With servo motor and gear unit			
EMME-AS-40-... EMGA-40-P-G...-EAS-40	40G	1456650	EAMM-A-S48-40G-G2
EMMT-AS-60-..., EMME-AS-60-... EMGA-60-P-G...-EAS-60	60H	1456652	EAMM-A-S48-60H-G2
With servo motor and right-angle gear unit			
EMME-AS-40-..., EMMB-AS-40-... EMGA-40-A-G...-40P	40G	1456650	EAMM-A-S48-40G-G2
EMMT-AS-60-..., EMME-AS-60-..., EMMB-AS-60-... EMGA-60-A-G...-60P	60H	1456652	EAMM-A-S48-60H-G2
With stepper motor			
EMMS-ST-57-...	57A	★ 3637963	EAMM-A-S48-57A-G2
Third-party motor	60AA	8105935	EAMM-A-S48-60AA
EMMS-ST-87-...	87A	★ 3637962	EAMM-A-S48-87A-G2
With stepper motor and gear unit			
EMMS-ST-42-... EMGA-40-P-G...-SST-42	40G	1456650	EAMM-A-S48-40G-G2
EMMS-ST-57-... EMGA-60-P-G...-SST-57	60G	2256701	EAMM-A-S48-60G-G2
With third-party gear unit			
Third-party gear unit	40G	1456650	EAMM-A-S48-40G-G2
Third-party gear unit	50GA	8105930	EAMM-A-S48-50GA
Third-party gear unit	60H	1456652	EAMM-A-S48-60H-G2

1) The input torque must not exceed the max. permissible transferable torque of the axial kit.



Product range overview

Permissible axis/motor combinations with ball screw (spindle) axis EGC-HD-BS

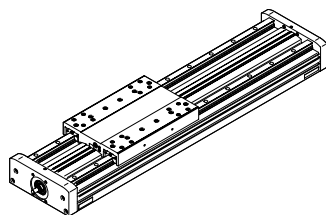

Table of interfaces for third-party motors

→ from page 64

Technical data for axial kits

→ from page 69

Motor/gear unit ¹⁾ Type	Motor interface	Axial kit	
		Part no.	Type
EGC-HD-220-...-BS			
With servo motor			
Third-party motor	70A	3637959	EAMM-A-S62-70A-G2
EMMT-AS-80-..., EMME-AS-80-..., EMMB-AS-80-..., third-party motor	80P	★ 3637970	EAMM-A-S62-80P-G2
Third-party motor	80PB, 80R	8110208	EAMM-A-S62-80PB
Third-party motor	82AA	8110211	EAMM-A-S62-82AA
Third-party motor	84AA	8110226	EAMM-A-S62-84AA
EMMT-AS-100-..., EMME-AS-100-..., third-party motor	100A	★ 3637960	EAMM-A-S62-100A-G2
EMMT-AS-150	150A	8157272	EAMM-A-S62-150A-G2
With servo motor and gear unit			
EMMT-AS-60-..., EMME-AS-60-... EMGA-60-P-G...-EAS-60	60H	1456654	EAMM-A-S62-60H-G2
EMMT-AS-80-..., EMME-AS-80-... EMGA-80-P-G...-EAS-80	80G	1972530	EAMM-A-S62-80G-G2
EMMT-AS-100-..., EMME-AS-100-... EMGA-80-P-G...-SAS-100	80G	1972530	EAMM-A-S62-80G-G2
With servo motor and right-angle gear unit			
EMMT-AS-60-..., EMME-AS-60-..., EMMB-AS-60-... EMGA-60-A-G...-60P	60H	1456654	EAMM-A-S62-60H-G2
EMMT-AS-80-..., EMME-AS-80-..., EMMB-AS-80-... EMGA-80-A-G...-80P	80G	1972530	EAMM-A-S62-80G-G2
EMMT-AS-100-..., EMME-AS-100-... EMGA-80-A-G...-100A	80G	1972530	EAMM-A-S62-80G-G2
With stepper motor			
EMMS-ST-87-...	87A	★ 3637966	EAMM-A-S62-87A-G2
With stepper motor and gear unit			
EMMS-ST-57-... EMGA-60-P-G...-SST-57	60G	2297649	EAMM-A-S62-60G-G2
EMMS-ST-87-... EMGA-80-P-G...-SST-87	80G	1972530	EAMM-A-S62-80G-G2
With third-party gear unit			
Third-party gear unit	60H	1456654	EAMM-A-S62-60H-G2
Third-party gear unit	70GA	8110082	EAMM-A-S62-70GA
Third-party gear unit	80G	1972530	EAMM-A-S62-80G-G2

1) The input torque must not exceed the max. permissible transferable torque of the axial kit.

Festo Core Range



Generally ready for shipping ex works in 24 hours

Generally ready for shipping ex works in 5 days

Product range overview

Permissible axis/motor combinations with cantilever axis ELCC-TB-...

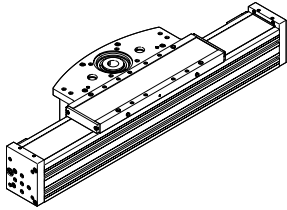

Table of interfaces for third-party motors

→ from page 64

Technical data for axial kits

→ from page 69

Motor/gear unit ¹⁾ Type	Motor interface	Axial kit	
		Part no.	Type
ELCC-TB-...-60			
With servo motor			
Third-party motor	60PA	8063590	EAMM-A-N48-60PA
Third-party motor	70AA, 70AB	8063591	EAMM-A-N48-70AA
EMMT-AS-80-..., EMME-AS-80-..., EMMB-AS-80-..., third-party motor	80P	8063592	EAMM-A-N48-80P
Third-party motor	80PB, 80R	8107714	EAMM-A-N48-80PB
Third-party motor	84AA	8063594	EAMM-A-N48-84AA
Third-party motor	88A	8063593	EAMM-A-N48-88A
With servo motor and gear unit			
EMMT-AS-60-..., EMME-AS-60-... EMGA-60-P-G...-EAS-60	60H	1456618	EAMM-A-N48-60H
EMMT-AS-80-..., EMME-AS-80-... EMGA-80-P-G...-EAS-80	80G	1258793	EAMM-A-N48-80G
With servo motor and right-angle gear unit			
EMMT-AS-60-..., EMME-AS-60-..., EMMB-AS-60-... EMGA-60-A-G...-60P	60H	1456618	EAMM-A-N48-60H
EMMT-AS-80-..., EMME-AS-80-..., EMMB-AS-80-... EMGA-80-A-G...-80P	80G	1258793	EAMM-A-N48-80G
ELCC-TB-...-70			
With servo motor			
EMMT-AS-100-..., EMME-AS-100-..., third-party motor	100A	1201894	EAMM-A-N48-100A
With servo motor and gear unit			
EMMT-AS-80-..., EMME-AS-80-... EMGA-80-P-G...-EAS-80	80G	1258793	EAMM-A-N48-80G
EMMT-AS-100-..., EMME-AS-100-... EMGA-80-P-G...-SAS-100	80G	1258793	EAMM-A-N48-80G
With servo motor and right-angle gear unit			
EMMT-AS-80-..., EMME-AS-80-..., EMMB-AS-80-... EMGA-80-A-G...-80P	80G	1258793	EAMM-A-N48-80G
EMMT-AS-100-..., EMME-AS-100-... EMGA-80-A-G...-100A	80G	1258793	EAMM-A-N48-80G
With third-party gear unit			
Third-party gear unit	50GA	8063595	EAMM-A-N48-50GA
Third-party gear unit	56GA	8063596	EAMM-A-N48-56GA
Third-party gear unit	70GA	8063597	EAMM-A-N48-70GA
Third-party gear unit	72GA	8063601	EAMM-A-N48-72GA
Third-party gear unit	75GA	8063598	EAMM-A-N48-75GA
Third-party gear unit	90GA	8063603	EAMM-A-N48-90GA
Third-party gear unit	90GB	8063602	EAMM-A-N48-90GB
Third-party gear unit	120GA	8063605	EAMM-A-N48-120GA

1) The input torque must not exceed the max. permissible transferable torque of the axial kit.

Product range overview

Permissible axis/motor combinations with cantilever axis ELCC-TB-...

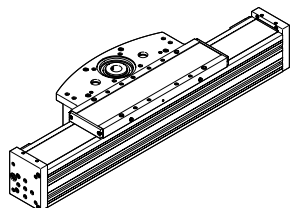

Table of interfaces for third-party motors

→ from page 64

Technical data for axial kits

→ from page 69

Motor/gear unit ¹⁾ Type	Motor interface	Axial kit	
		Part no.	Type
ELCC-TB-...-90			
With servo motor			
EMMT-AS-100-..., EMME-AS-100-..., third-party motor	100A	8063607	EAMM-A-N80-100A
EMMT-AS-150-...	150A	8157277	EAMM-A-N80-150A
With servo motor and gear unit			
EMMT-AS-100-..., EMME-AS-100-... EMGA-80-P-G...-SAS-100	80G	2372096	EAMM-A-N80-80G
With servo motor and right-angle gear unit			
EMMT-AS-100-..., EMME-AS-100-... EMGA-80-A-...-100A	80G	2372096	EAMM-A-N80-80G
With third-party gear unit			
Third-party gear unit	68GA	8063611	EAMM-A-N80-68GA
Third-party gear unit	70GA	8063608	EAMM-A-N80-70GA
Third-party gear unit	72GA	8063612	EAMM-A-N80-72GA
Third-party gear unit	75GA	8063609	EAMM-A-N80-75GA
Third-party gear unit	90GA	8063614	EAMM-A-N80-90GA
Third-party gear unit	90GB	8063613	EAMM-A-N80-90GB
Third-party gear unit	115GA	8063615	EAMM-A-N80-115GA
Third-party gear unit	120GA	8063617	EAMM-A-N80-120GA
Third-party gear unit	120GB	8063618	EAMM-A-N80-120GB
Third-party gear unit	120GC	8063619	EAMM-A-N80-120GC
ELCC-TB-...-110			
With servo motor and gear unit			
EMMT-AS-100-..., EMME-AS-100-... EMGA-80-P-G...-SAS-100	80G	3660191	EAMM-A-L95-80G-G2
EMMT-AS-100-..., EMME-AS-100-... EMGA-120-P-G...-SAS-100	120G	★ 3659941	EAMM-A-L95-120G-G2
EMMT-AS-150-... EMGA-120-P-G...-SAS-140	120G	3659941	EAMM-A-L95-120G-G2
EMMT-AS-150-... EMGA-160-P-G...-SAS-140	160G	9063532	EAMM-A-L95-160G
With servo motor and right-angle gear unit			
EMMT-AS-100-..., EMME-AS-100-... EMGA-80-A-G...-100A	80G	3660191	EAMM-A-L95-80G-G2
With third-party gear unit			
Third-party gear unit	68GA	8063524	EAMM-A-L95-68GA
Third-party gear unit	72GA	8063525	EAMM-A-L95-72GA
Third-party gear unit	75GA	8063522	EAMM-A-L95-75GA
Third-party gear unit	90GA	8063526	EAMM-A-L95-90GA
Third-party gear unit	115GA	8063527	EAMM-A-L95-115GA
Third-party gear unit	120GA	8063529	EAMM-A-L95-120GA
Third-party gear unit	120GB	8063530	EAMM-A-L95-120GB
Third-party gear unit	120GC	8063531	EAMM-A-L95-120GC

1) The input torque must not exceed the max. permissible transferable torque of the axial kit.

Festo Core Range



Generally ready for shipping ex works in 24 hours

Generally ready for shipping ex works in 5 days

Product range overview

Permissible axis/motor combinations with mini slide EGSL

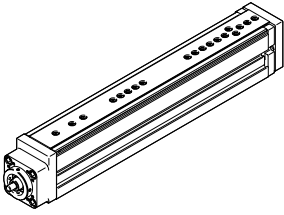

Table of interfaces for third-party motors

→ from page 64

Technical data for axial kits

→ from page 69

Motor/gear unit ¹⁾	Motor interface	Axial kit	
		Part no.	Type
EGSL-35			
With servo motor			
Third-party motor	38AA	8105863	EAMM-A-D19-38AA
EMME-AS-40-..., EMMB-AS-40-...	40P	1981953	EAMM-A-D19-40P
Third-party motor	40A	1199152	EAMM-A-D19-40A
Third-party motor	40R	8105867	EAMM-A-D19-40R
With stepper motor			
EMMS-ST-28-...	28A	1081659	EAMM-A-D19-28A
EMMS-ST-42-..., third-party motor	42A	1087642	EAMM-A-D19-42A
EGSL-45			
With servo motor			
Third-party motor	40A	543147	EAMM-A-D32-40A
EMME-AS-40-..., EMMB-AS-40-...	40P	★ 1976465	EAMM-A-D32-40P
Third-party motor	40R	8105826	EAMM-A-D32-40R
Third-party motor	40RA	8125610	EAMM-A-D32-40RA
Third-party motor	55A	550979	EAMM-A-D32-55A
Third-party motor	58AA	8105884	EAMM-A-D32-58AA
EMMT-AS-60-..., EMME-AS-60-..., EMMB-AS-60-..., third-party motor	60P	★ 1956054	EAMM-A-D32-60P
Third-party motor	60R	8105918	EAMM-A-D32-60R
Third-party motor	60RA	8105889	EAMM-A-D32-60RA
With servo motor and gear unit			
EMME-AS-40-... EMGA-40-P-G...-EAS-40	40G	1454238	EAMM-A-D32-40G
EMMT-AS-60-..., EMME-AS-60-... EMGA-60-P-G...-EAS-60	60H	2946760	EAMM-A-D32-60H
With servo motor and right-angle gear unit			
EMME-AS-40-..., EMMB-AS-40-... EMGA-40-A-G...-40P	40G	1454238	EAMM-A-D32-40G
EMMT-AS-60-..., EMME-AS-60-..., EMMB-AS-60-... EMGA-60-A-G...-60P	60H	2946760	EAMM-A-D32-60H

1) The input torque must not exceed the max. permissible transferable torque of the axial kit.

Product range overview

Permissible axis/motor combinations with mini slide EGSL

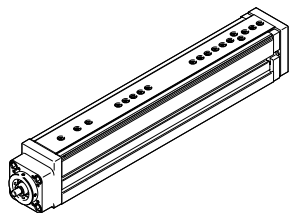

Table of interfaces for third-party motors

→ from page 64

Technical data for axial kits

→ from page 69

Motor/gear unit ¹⁾ Type	Motor interface	Axial kit	
		Part no.	Type
EGSL-45			
With stepper motor			
EMMS-ST-42-..., third-party motor	42A	★ 543148	EAMM-A-D32-42A
EMMS-ST-57-...	57A	★ 550980	EAMM-A-D32-57A
Third-party motor	60AA	8105887	EAMM-A-D32-60AA
With stepper motor and gear unit			
EMMS-ST-42-... EMGA-40-P-G...-SST-42	40G	1454238	EAMM-A-D32-40G
EMMS-ST-57-... EMGA-60-P-G...-SST-57	60G	2946758	EAMM-A-D32-60G
With third-party gear unit			
Third-party gear unit	40G	1454238	EAMM-A-D32-40G
Third-party gear unit	50GA	8117072	EAMM-A-D32-50GA
Third-party gear unit	60H	2946760	EAMM-A-D32-60H

1) The input torque must not exceed the max. permissible transferable torque of the axial kit.

Festo Core Range



Generally ready for shipping ex works in 24 hours

Generally ready for shipping ex works in 5 days

Product range overview

Permissible axis/motor combinations with mini slide EGSL

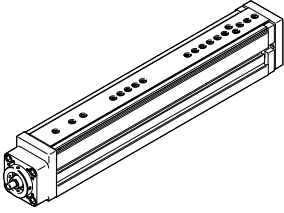

Table of interfaces for third-party motors

→ from page 64

Technical data for axial kits

→ from page 69

Motor/gear unit ¹⁾	Motor interface	Axial kit	
		Part no.	Type
EGSL-55			
With servo motor			
Third-party motor	55A	543153	EAMM-A-D40-55A
Third-party motor	58AA	8105928	EAMM-A-D40-58AA
EMMT-AS-60-..., EMME-AS-60-..., EMMB-AS-60-..., third-party motor	60P	★ 1977000	EAMM-A-D40-60P
Third-party motor	60R	8117079	EAMM-A-D40-60R
Third-party motor	60RA	8117078	EAMM-A-D40-60RA
Third-party motor	70A	550981	EAMM-A-D40-70A
Third-party motor	70AA, 70AB	8105952	EAMM-A-D40-70AA
With servo motor and gear unit			
EMME-AS-40-... EMGA-40-P-G...-EAS-40	40G	2256398	EAMM-A-D40-40G-G2 ²⁾
EMMT-AS-60-... EMGA-60-P-G...-EAS-60	60H	1454242	EAMM-A-D40-60H
EMME-AS-60-... EMGA-60-P-G...-EAS-60	60H	1454242	EAMM-A-D40-60H
With servo motor and right-angle gear unit			
EMME-AS-40-..., EMMB-AS-40-... EMGA-40-A-G...-40P	40G	2256398	EAMM-A-D40-40G-G2 ²⁾
EMMT-AS-60-..., EMMB-AS-60-... EMGA-60-A-G...-60P	60H	1454242	EAMM-A-D40-60H
EMME-AS-60-..., EMMB-AS-60-... EMGA-60-A-G...-60P	60H	1454242	EAMM-A-D40-60H
With stepper motor			
EMMS-ST-57-...	57A	★ 543154	EAMM-A-D40-57A
Third-party motor	60AA	8105929	EAMM-A-D40-60AA
EMMS-ST-87-...	87A	★ 550982	EAMM-A-D40-87A
With stepper motor and gear unit			
EMMS-ST-42-... EMGA-40-P-G...-SST-42	40G	2256398	EAMM-A-D40-40G-G2 ²⁾
EMMS-ST-57-... EMGA-60-P-G...-SST-57	60G	2256400	EAMM-A-D40-60G
With third-party gear unit			
Third-party gear unit	50GA	8117076	EAMM-A-D40-50GA
Third-party gear unit	60H	1454242	EAMM-A-D40-60H

1) The input torque must not exceed the max. permissible transferable torque of the axial kit.

2) The axial kit can be retrofitted from IP40 to IP65 with the help of a seal set EADS-F → page 110



Product range overview

Permissible axis/motor combinations with mini slide EGSL

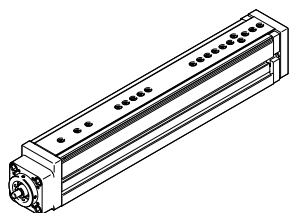

Table of interfaces for third-party motors

→ from page 64

Technical data for axial kits

→ from page 69

Motor/gear unit ¹⁾	Motor interface	Axial kit	
		Part no.	Type
EGSL-75			
With servo motor			
Third-party motor	70A	543161	EAMM-A-D60-70A
EMMT-AS-80-..., EMME-AS-80-..., EMMB-AS-80-..., third-party motor	80P	★ 1977073	EAMM-A-D60-80P
Third-party motor	80PB, 80R	8105937	EAMM-A-D60-80PB
Third-party motor	84AA	8105945	EAMM-A-D60-84AA
Third-party motor	92RA	8159834	EAMM-A-D60-92RA
EMMT-AS-100-..., EMME-AS-100-..., third-party motor	100A	★ 550983	EAMM-A-D60-100A
With servo motor and gear unit			
EMMT-AS-60-..., EMME-AS-60-... EMGA-60-P-G...-EAS-60	60H	1454245	EAMM-A-D60-60H
EMMT-AS-80-..., EMME-AS-80-... EMGA-80-P-G...-EAS-80	80G	1499402	EAMM-A-D60-80G
EMMT-AS-100-..., EMME-AS-100-... EMGA-80-P-G...-SAS-100	80G	1499402	EAMM-A-D60-80G
With servo motor and right-angle gear unit			
EMMT-AS-60-..., EMME-AS-60-..., EMMB-AS-60-... EMGA-60-A-G...-60P	60H	1454245	EAMM-A-D60-60H
EMMT-AS-80-..., EMME-AS-80-..., EMMB-AS-80-... EMGA-80-A-G...-80P	80G	1499402	EAMM-A-D60-80G
EMMT-AS-100-..., EMME-AS-100-... EMGA-80-A-G...-100A	80G	1499402	EAMM-A-D60-80G
With stepper motor			
EMMS-ST-87-...	87A	★ 543162	EAMM-A-D60-87A
With stepper motor and gear unit			
EMMS-ST-57-... EMGA-60-P-G...-SST-57	60G	2256696	EAMM-A-D60-60G-G2 ³⁾
EMMS-ST-87-... EMGA-80-P-G...-SST-87	80G	1499402	EAMM-A-D60-80G
With third-party gear unit			
Third-party gear unit	60H	1454245	EAMM-A-D60-60H
Third-party gear unit	80G	1499402	EAMM-A-D60-80G
Third-party gear unit	90GA	8105944	EAMM-A-D60-90GA

1) The input torque must not exceed the max. permissible transferable torque of the axial kit.

2) The axial kit can be retrofitted from IP40 to IP65 with the help of a seal set EADS-F → page 110



Product range overview

Permissible axis/motor combinations with mini slide EGSC

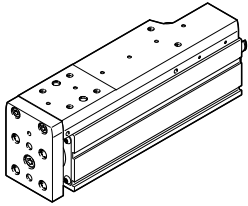

Table of interfaces for third-party motors

→ from page 64

Technical data for axial kits

→ from page 69

Motor ¹⁾ Type	Motor interface	Axial kit	
		Part no.	Type
EGSC-25			
With stepper motor			
EMMS-ST-28-...	28A	4505258	EAMM-A-V20-28A
Third-party motor	28AA	8093016	EAMM-A-V20-28AA
EGSC-32			
With servo motor			
Third-party motor	38AA	8093162	EAMM-A-V25-38AA
EMME-AS-40-..., EMMB-AS-40-...	40P	4491059	EAMM-A-V25-40P
Third-party motor	40R	8087062	EAMM-A-V25-40R
Third-party motor	40RA	8094100	EAMM-A-V25-40RA
With stepper motor			
Third-party motor	35A, 35AB	8093255	EAMM-A-V25-35A
EMMS-ST-42-..., third-party motor	42A	4582608	EAMM-A-V25-42A
Third-party motor	42AB	8094108	EAMM-A-V25-42AB
EGSC-45			
With servo motor			
Third-party motor	38AA	8093023	EAMM-A-V32-38AA
EMME-AS-40-..., EMMB-AS-40-...	40P	4595742	EAMM-A-V32-40P
Third-party motor	40R	8087090	EAMM-A-V32-40R
Third-party motor	40RA	8094180	EAMM-A-V32-40RA
Third-party motor	58AA	8098982	EAMM-A-V32-58AA
EMMT-AS-60-..., EMME-AS-60-..., EMMB-AS-60-...	60P	4608750	EAMM-A-V32-60P
Third-party motor	60PA	8091053	EAMM-A-V32-60PA
Third-party motor	60RA	8093041	EAMM-A-V32-60RA
With stepper motor			
EMMS-ST-42-..., third-party motor	42A	4281142	EAMM-A-V32-42A
Third-party motor	42AB	8094200	EAMM-A-V32-42AB
EMMS-ST-57-...	57A	4597016	EAMM-A-V32-57A
Third-party motor	60AA	8092271	EAMM-A-V32-60AA
EGSC-60			
With servo motor			
Third-party motor	55A	8082614	EAMM-A-T42-55A
Third-party motor	58AA	8094935	EAMM-A-T42-58AA
EMMT-AS-60-..., EMME-AS-60-..., EMMB-AS-60-...	60P, 60PA	4133487	EAMM-A-T42-60P
Third-party motor	60R	8093289	EAMM-A-T42-60R
Third-party motor	60RA	8092264	EAMM-A-T42-60RA
EMMT-AS-80-..., EMME-AS-80-..., EMMB-AS-80-...	80P	4623788	EAMM-A-T42-80P
With stepper motor			
EMMS-ST-57-...	57A	4327034	EAMM-A-T42-57A
Third-party motor	60AA	8092255	EAMM-A-T42-60AA
Third-party motor	60AB	8094949	EAMM-A-T42-60AB
EMMS-ST-87-...	87A	4610008	EAMM-A-T42-87A

1) The input torque must not exceed the max. permissible transferable torque of the axial kit.

Product range overview

Permissible axis/motor combinations with electric slide EGSK

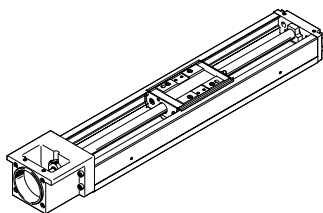

Table of interfaces for third-party motors

→ from page 64

Technical data for axial kits

→ from page 69

Motor/gear unit ¹⁾ Type	Motor interface	Axial kit	
		Part no.	Type
EGSK-15			
With servo motor			
EMME-AS-40-..., EMMB-AS-40-...	40P	1982886	EAMM-A-P3-28D-40P
With stepper motor			
EMMS-ST-28-...	28A	1703478	EAMM-A-P3-28D-28A
EGSK-20			
With servo motor			
Third-party motor	38AA	8107704	EAMM-A-P4-28B-38AA
Third-party motor	40A	562637	EAMM-A-P4-28B-40A
EMME-AS-40-..., EMMB-AS-40-...	40P	1983071	EAMM-A-P4-28B-40P
Third-party motor	40R	8107707	EAMM-A-P4-28B-40R
Third-party motor	40RA	8107708	EAMM-A-P4-28B-40RA
With stepper motor			
EMMS-ST-28-...	28A	1731466	EAMM-A-P4-28B-28A
EMMS-ST-42-..., third-party motor	42A	562636	EAMM-A-P4-28B-42A
EGSK-26			
With servo motor			
Third-party motor	38AA	8107710	EAMM-A-P5-28B-38AA
Third-party motor	40A	562641	EAMM-A-P5-28B-40A
EMME-AS-40-..., EMMB-AS-40-...	40P	1983122	EAMM-A-P5-28B-40P
Third-party motor	40R	8107711	EAMM-A-P5-28B-40R
Third-party motor	40RA	8107712	EAMM-A-P5-28B-40RA
With stepper motor			
EMMS-ST-28-...	28A	1731474	EAMM-A-P5-28B-28A
EMMS-ST-42-..., third-party motor	42A	562640	EAMM-A-P5-28B-42A
EGSK-33			
With servo motor			
Third-party motor	40A	562646	EAMM-A-P6-38A-40A
EMME-AS-40-..., EMMB-AS-40-...	40P	1983450	EAMM-A-P6-38A-40P
Third-party motor	55A	562647	EAMM-A-P6-38A-55A
Third-party motor	58AA	8123494	EAMM-A-P6-38A-58AA
EMMT-AS-60-..., EMME-AS-60-..., EMMB-AS-60-..., third-party motor	60P	2264375	EAMM-A-P6-38A-60P
Third-party motor	60R	8123495	EAMM-A-P6-38A-60R
Third-party motor	60RA	8123496	EAMM-A-P6-38A-60RA
With servo motor and gear unit			
EMME-AS-40-...	40G	2297645	EAMM-A-P6-38A-40G
EMGA-40-P-G...-EAS-40			

1) The input torque must not exceed the max. permissible transferable torque of the axial kit.

Product range overview

Permissible axis/motor combinations with electric slide EGSK

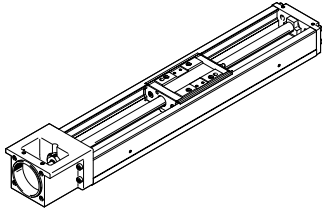

Table of interfaces for third-party motors

→ from page 64

Technical data for axial kits

→ from page 69

Motor/gear unit ¹⁾ Type	Motor interface	Axial kit	
		Part no.	Type
EGSK-33			
With stepper motor			
EMMS-ST-42-..., third-party motor	42A	562644	EAMM-A-P6-38A-42A
EMMS-ST-57-...	57A	562645	EAMM-A-P6-38A-57A
With stepper motor and gear unit			
EMMS-ST-42-... EMGA-40-P-G...-SST-42	40G	2297645	EAMM-A-P6-38A-40G
EGSK-46			
With servo motor			
Third-party motor	40A	562652	EAMM-A-P8-38A-40A
EMME-AS-40-..., EMMB-AS-40-...	40P	1986292	EAMM-A-P8-38A-40P
Third-party motor	55A	562653	EAMM-A-P8-38A-55A
Third-party motor	58AA	8105910	EAMM-A-P8-38A-58AA
EMMT-AS-60-..., EMME-AS-60-..., EMMB-AS-60-..., third-party motor	60P	1987308	EAMM-A-P8-38A-60P
Third-party motor	60R	8105916	EAMM-A-P8-38A-60R
Third-party motor	60RA	8105914	EAMM-A-P8-38A-60RA
Third-party motor	70A	564996	EAMM-A-P8-38A-70A
Third-party motor	70AA, 70AB	8105920	EAMM-A-P8-38A-70AA
With servo motor and gear unit			
EMME-AS-40-... EMGA-40-P-G...-EAS-40	40G	2297646	EAMM-A-P8-38A-40G
With stepper motor			
EMMS-ST-42-..., third-party motor	42A	562650	EAMM-A-P8-38A-42A
EMMS-ST-57-...	57A	562651	EAMM-A-P8-38A-57A
Third-party motor	60AA	8105913	EAMM-A-P8-38A-60AA
EMMS-ST-87-...	87A	564998	EAMM-A-P8-38A-87A
With stepper motor and gear unit			
EMMS-ST-42-... EMGA-40-P-G...-SST-42	40G	2297646	EAMM-A-P8-38A-40G

1) The input torque must not exceed the max. permissible transferable torque of the axial kit.

Product range overview

Permissible axis/motor combinations with toothed belt axis ELGR, ELGG

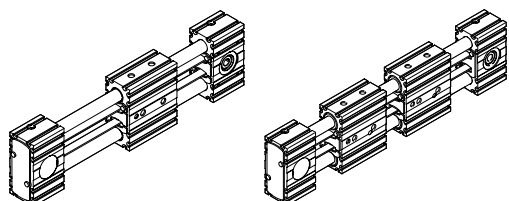

Table of interfaces for third-party motors

→ from page 64

Technical data for axial kits

→ from page 69

Motor/gear unit ¹⁾ Type	Motor interface	Axial kit	
		Part no.	Type
ELGR-35, ELGG-35			
With servo motor			
Third-party motor	55A	1133400	EAMM-A-R27-55A
With servo motor and gear unit			
EMME-AS-40-... EMGA-40-P-G...-EAS-40	40G	1456622	EAMM-A-R27-40G
With servo motor and right-angle gear unit			
EMME-AS-40-..., EMMB-AS-40-... EMGA-40-A-G...-40P	40G	1456622	EAMM-A-R27-40G
With stepper motor			
EMMS-ST-57-...	57A	★ 1133403	EAMM-A-R27-57A
With stepper motor and gear unit			
EMMS-ST-42-... EMGA-40-P-G...-SST-42	40G	1456622	EAMM-A-R27-40G
ELGR-45, ELGG-45			
With servo motor			
EMMT-AS-60-..., EMME-AS-60-..., EMMB-AS-60-..., third-party motor	60P	★ 2224996	EAMM-A-R38-60P
Third-party motor	70A	1133401	EAMM-A-R38-70A
With servo motor and gear unit			
EMME-AS-40-... EMGA-40-P-G...-EAS-40	40G	1456623	EAMM-A-R38-40G
EMMT-AS-60-..., EMME-AS-60-... EMGA-60-P-G...-EAS-60	60H	1456630	EAMM-A-R38-60H
With servo motor and right-angle gear unit			
EMME-AS-40-..., EMMB-AS-40-... EMGA-40-A-G...-40P	40G	1456623	EAMM-A-R38-40G
EMMT-AS-60-..., EMME-AS-60-..., EMMB-AS-60-... EMGA-60-A-G...-60P	60H	1456630	EAMM-A-R38-60H

Festo Core Range



Generally ready for shipping ex works in 24 hours

Generally ready for shipping ex works in 5 days

Product range overview

Permissible axis/motor combinations with toothed belt axis ELGR, ELGG

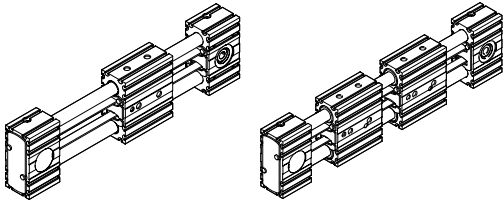

Table of interfaces for third-party motors

→ from page 64

Technical data for axial kits

→ from page 69

Motor/gear unit ¹⁾ Type	Motor interface	Axial kit	
		Part no.	Type
ELGR-45, ELGG-45			
With stepper motor			
EMMS-ST-57-...	57A	★ 1578138	EAMM-A-R38-57A
EMMS-ST-87-...	87A	★ 1133404	EAMM-A-R38-87A
With stepper motor and gear unit			
EMMS-ST-42-... EMGA-40-P-G...-SST-42	40G	1456623	EAMM-A-R38-40G
EMMS-ST-57-... EMGA-60-P-G...-SST-57	60G	2310075	EAMM-A-R38-60G
ELGR-55, ELGG-55			
With servo motor			
Third-party motor	70A	1578139	EAMM-A-R48-70A
EMMT-AS-80-..., EMME-AS-80-..., EMMB-AS-80-..., third-party motor	80P	★ 2225090	EAMM-A-R48-80P
EMMT-AS-100-..., EMME-AS-100-..., third-party motor	100A	★ 1133402	EAMM-A-R48-100A
With servo motor and gear unit			
EMMT-AS-60-..., EMME-AS-60-... EMGA-60-P-G...-EAS-60	60H	1456633	EAMM-A-R48-60H
With servo motor and right-angle gear unit			
EMMT-AS-60-..., EMME-AS-60-..., EMMB-AS-60-... EMGA-60-A-G...-60P	60H	1456633	EAMM-A-R48-60H
With stepper motor			
EMMS-ST-87-...	87A	★ 1133405	EAMM-A-R48-87A
With stepper motor and gear unit			
EMMS-ST-57-... EMGA-60-P-G...-SST-57	60G	2374780	EAMM-A-R48-60G

1) The input torque must not exceed the max. permissible transferable torque of the axial kit.



Product range overview

Permissible axis/motor combinations with rotary module ERMB, EHMB

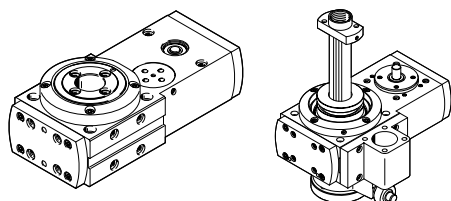

Table of interfaces for third-party motors

→ from page 64

Technical data for axial kits

→ from page 69

Motor/gear unit ¹⁾	Motor interface	Axial kit	
		Part no.	Type
ERMB-20, EHMB-20			
With servo motor			
EMME-AS-40-..., EMMB-AS-40-...	40P	2207441	EAMM-A-D32-35A-40P
Third-party motor	40A	560281	EAMM-A-D32-35A-40A
Third-party motor	40R	8105826	EAMM-A-D32-40R
Third-party motor	40RA	8125610	EAMM-A-D32-40RA
Third-party motor	55A	550979	EAMM-A-D32-55A
Third-party motor	58AA	8105884	EAMM-A-D32-58AA
EMMT-AS-60-..., EMME-AS-60-..., EMMB-AS-60-..., third-party motor	60P	★ 1956054	EAMM-A-D32-60P
Third-party motor	60R	8105918	EAMM-A-D32-60R
Third-party motor	60RA	8105889	EAMM-A-D32-60RA
With servo motor and gear unit			
EMME-AS-40-...	40G	1454238	EAMM-A-D32-40G
EMGA-40-P-G...-EAS-40			
EMMT-AS-60-..., EMME-AS-60-...	60H	2946760	EAMM-A-D32-60H
EMGA-60-P-G...-EAS-60			
With servo motor and right-angle gear unit			
EMME-AS-40-..., EMMB-AS-40-...	40G	1454238	EAMM-A-D32-40G
EMGA-40-A-G...-40P			
EMMT-AS-60-..., EMME-AS-60-..., EMMB-AS-60-...	60H	2946760	EAMM-A-D32-60H
EMGA-60-A-G...-60P			
With stepper motor			
EMMS-ST-42-..., third-party motor	42A	★ 543148	EAMM-A-D32-42A
EMMS-ST-57-...	57A	★ 550980	EAMM-A-D32-57A
Third-party motor	60AA	8105887	EAMM-A-D32-60AA
With stepper motor and gear unit			
EMMS-ST-42-...	40G	1454238	EAMM-A-D32-40G
EMGA-40-P-G...-SST-42			
EMMS-ST-57-...	60G	2946758	EAMM-A-D32-60G
EMGA-60-P-G...-SST-57			
With third-party gear unit			
Third-party gear unit	50GA	8117072	EAMM-A-D32-50GA

1) The input torque must not exceed the max. permissible transferable torque of the axial kit.

Festo Core Range



Generally ready for shipping ex works in 24 hours

Generally ready for shipping ex works in 5 days

Product range overview

Permissible axis/motor combinations with rotary module ERMB, EHMB

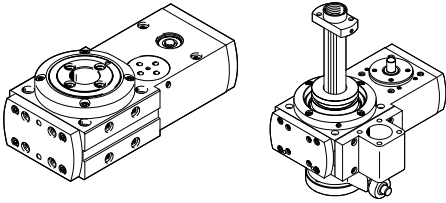

Table of interfaces for third-party motors

→ from page 64

Technical data for axial kits

→ from page 69

Motor/gear unit ¹⁾	Motor interface	Axial kit	
		Part no.	Type
ERMB-25, EHMB-25			
With servo motor			
Third-party motor	55A	543153	EAMM-A-D40-55A
Third-party motor	58AA	8105928	EAMM-A-D40-58AA
EMMT-AS-60-..., EMME-AS-60-..., EMMB-AS-60-..., third-party motor	60P	★ 1977000	EAMM-A-D40-60P
Third-party motor	60R	8117079	EAMM-A-D40-60R
Third-party motor	60RA	8117078	EAMM-A-D40-60RA
Third-party motor	70A	550981	EAMM-A-D40-70A
Third-party motor	70AA, 70AB	8105952	EAMM-A-D40-70AA
With servo motor and gear unit			
EMME-AS-40-... EMGA-40-P-G...-EAS-40	40G	2256398	EAMM-A-D40-40G-G2 ²⁾
EMMT-AS-60-..., EMME-AS-60-... EMGA-60-P-G...-EAS-60	60H	1454242	EAMM-A-D40-60H
With servo motor and right-angle gear unit			
EMME-AS-40-..., EMMB-AS-40-... EMGA-40-A-G...-40P	40G	2256398	EAMM-A-D40-40G-G2 ²⁾
EMMT-AS-60-..., EMME-AS-60-..., EMMB-AS-60-... EMGA-60-A-G...-60P	60H	1454242	EAMM-A-D40-60H
With stepper motor			
EMMS-ST-57-...	57A	★ 543154	EAMM-A-D40-57A
Third-party motor	60AA	8105929	EAMM-A-D40-60AA
EMMS-ST-87-...	87A	★ 550982	EAMM-A-D40-87A
With stepper motor and gear unit			
EMMS-ST-42-... EMGA-40-P-G...-SST-42	40G	2256398	EAMM-A-D40-40G-G2 ²⁾
EMMS-ST-57-... EMGA-60-P-G...-SST-57	60G	2256400	EAMM-A-D40-60G
With third-party gear unit			
Third-party gear unit	40G	2256398	EAMM-A-D40-40G-G2 ²⁾
Third-party gear unit	50GA	8117076	EAMM-A-D40-50GA
Third-party gear unit	60H	1454242	EAMM-A-D40-60H

1) The input torque must not exceed the max. permissible transferable torque of the axial kit.

2) The axial kit can be retrofitted from IP40 to IP65 with the help of a seal set EADS-F → page 110



Product range overview

Permissible axis/motor combinations with rotary module ERMB, EHMB

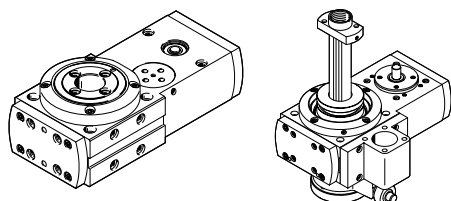

Table of interfaces for third-party motors

→ from page 64

Technical data for axial kits

→ from page 69

Motor/gear unit ¹⁾ Type	Motor interface	Axial kit	
		Part no.	Type
ERMB-32, EHMB-32			
With servo motor			
Third-party motor	70A	543161	EAMM-A-D60-70A
EMMT-AS-80-..., EMME-AS-80-..., EMMB-AS-80-..., third-party motor	80P	★ 1977073	EAMM-A-D60-80P
Third-party motor	80PB, 80R	8105937	EAMM-A-D60-80PB
Third-party motor	84AA	8105945	EAMM-A-D60-84AA
Third-party motor	92RA	8159834	EAMM-A-D60-92RA
EMMT-AS-100-..., EMME-AS-100-..., third-party motor	100A	★ 550983	EAMM-A-D60-100A
With servo motor and gear unit			
EMMT-AS-60-..., EMME-AS-60-... EMGA-60-P-G...-EAS-60	60H	1454245	EAMM-A-D60-60H
EMMT-AS-80-..., EMME-AS-80-... EMGA-80-P-G...-EAS-80	80G	1499402	EAMM-A-D60-80G
EMMT-AS-100-..., EMME-AS-100-... EMGA-80-P-G...-SAS-100	80G	1499402	EAMM-A-D60-80G
With servo motor and right-angle gear unit			
EMMT-AS-60-..., EMME-AS-60-..., EMMB-AS-60-... EMGA-60-A-G...-60P	60H	1454245	EAMM-A-D60-60H
EMMT-AS-80-..., EMME-AS-80-..., EMMB-AS-80-... EMGA-80-A-G...-80P	80G	1499402	EAMM-A-D60-80G
EMMT-AS-100-..., EMME-AS-100-... EMGA-80-A-G...-100A	80G	1499402	EAMM-A-D60-80G
With stepper motor			
EMMS-ST-87-...	87A	★ 543162	EAMM-A-D60-87A
With stepper motor and gear unit			
EMMS-ST-57-... EMGA-60-P-G...-SST-57	60G	2256696	EAMM-A-D60-60G-G2 ³⁾
EMMS-ST-87-... EMGA-80-P-G...-SST-87	80G	1499402	EAMM-A-D60-80G
With third-party gear unit			
Third-party gear unit	60H	1454245	EAMM-A-D60-60H
Third-party gear unit	80G	1499402	EAMM-A-D60-80G
Third-party gear unit	90GA	8105944	EAMM-A-D60-90GA

1) The input torque must not exceed the max. permissible transferable torque of the axial kit.

2) The axial kit can be retrofitted from IP40 to IP65 with the help of a seal set EADS-F → page 110.



Product range overview

Permissible axis/motor combinations with planar surface gantry EXCM

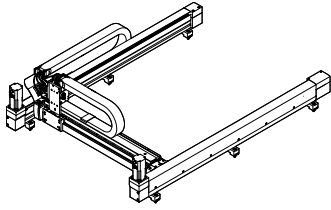

Technical data for axial kits
→ from page 69

Motor/gear unit ¹⁾ Type	Motor interface	Axial kit	
		Part no.	Type
EXCM-40			
With stepper motor			
EMMS-ST-57-...	87A	8165289	EAMM-A-X48-57A

1) The input torque must not exceed the max. permissible transferable torque of the axial kit.

Permissible axis/motor combinations with planar surface gantry EXCH

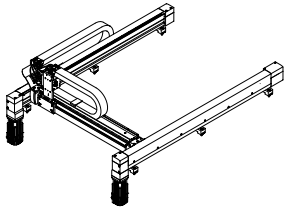

Technical data for axial kits
→ from page 69

Motor/gear unit ¹⁾ Type	Motor interface	Axial kit	
		Part no.	Type
EXCH-40			
With servo motor			
EMMT-AS-80-..., EMMB-AS-80-...	80P	8164654	EAMM-A-X48-80P
EXCH-60			
With servo motor			
EMMT-AS-100-...	100A	8164656	EAMM-A-X62-100A
EMMT-AS-150-...	150A	8164657	EAMM-A-X62-150A

1) The input torque must not exceed the max. permissible transferable torque of the axial kit.

Product range overview

Permissible axis/motor combinations with linear gantry EXCT

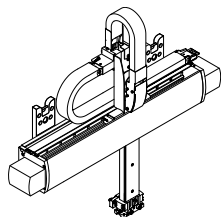

Technical data for axial kits
→ from page 69

Motor/gear unit ¹⁾ Type	Motor interface	Axial kit	
		Part no.	Type
EXCT-15			
With servo motor			
EMMT-AS-80-..., EMMB-AS-80-...	80P	8164277	EAMM-A-L48-80P-G2
EXCT-30			
With servo motor			
EMMT-AS-100-...	100A	8164409	EAMM-A-Y62-100A
EXCT-100			
With servo motor			
EMMT-AS-100-...	100A	8164276	EAMM-A-L62-100A-G2

1) The input torque must not exceed the max. permissible transferable torque of the axial kit.

Product range overview

Third-party motors and gear units		
Manufacturer	Motor interface	Type
Allen-Bradley/Rockwell Automation	40R	TL-A110; TL-A120; TL-A130; TLY-A110; TLY-A120; TLY-A130
Allen-Bradley/Rockwell Automation	55A	MPL-A/B1510; MPL-A/B1520; MPL-A/B1530; VPL-A/B-063x
Allen-Bradley/Rockwell Automation	60R	TL-A220; TL-A230; TLY-A220; TLY-A230
Allen-Bradley/Rockwell Automation	70A	MPL-A/B210; MPL-A/B220; MPL-A/B230; VPL-A/B-075x
Allen-Bradley/Rockwell Automation	80R	TLx-A25
Allen-Bradley/Rockwell Automation	90R	TLY-A310
Allen-Bradley/Rockwell Automation	92RA	MPF-B310; MPL-B320; MPL-B330; VPL-A/B1001; VPL-A/B1002; VPL-A/B1003
Allen-Bradley/Rockwell Automation	100A	VPL-A/B1152; VPL-A/B1153; MPL-A/B420; MPL-A/B430
Allen-Bradley/Rockwell Automation	108AA	VPL-A/B1303; VPL-A/B1304; VPL-A/B1306; MPL-A/B4530; MPL-A/B4540; MPL-A/B4560
Allen-Bradley/Rockwell Automation	190A	B640; B660; B690
AMK	55A	DT3
AMK	70A	DT4-1; DT4-2
AMK	100A	DT5-15; DT5-23; DT5-3; DT5-5; DT5-9; DTK5-3
Apex Dynamics INC.	40G	PG040
Apex Dynamics INC.	50GA	PE 050
Apex Dynamics INC.	60H	PG060
Apex Dynamics INC.	70GA	PE 070
Apex Dynamics INC.	80G	PG080
Apex Dynamics INC.	90GA	PE 090
Apex Dynamics INC.	120GA	PG080A
Apex Dynamics INC.	120GC	PE 120
Apex Dynamics INC.	160G	PG160
B+R Automation	40G	8GP30-040
B+R Automation	40R	8LVA1
B+R Automation	55A	8LSA2
B+R Automation	57AA	80MPF
B+R Automation	58AA	8JSA2
B+R Automation	60H	8GP30-060; 8GP40-060
B+R Automation	60PA	8LVA22; 8LVA23
B+R Automation	70AA	8JSA3
B+R Automation	72GA	8GP60-070
B+R Automation	80G	8GP40-080
B+R Automation	80PA	8LVA3
B+R Automation	84AA	8JSA4
B+R Automation	88A	8LSA3; 8MSA3
B+R Automation	100A	8LSA4; 8MSA4; 8MSC4
Baumüller	55A	DSD 028 M; DSD 028 S
Baumüller	70A	DSD 036 M; DSD 036 S
Baumüller	88A	DS 045 L; DS 045 M; DS 045 S; DSC 045 K; DSC 045 M; DSC 045 S; DSCG 045 K; DSCG 045 M; DSCG 045 S; DSD 045 L; DSD 045 M; DSD 045 S
Baumüller	126AA	DSC 056 K; DSC 056 M; DSC 056 S; DSCG 056 K; DSCG 056 M; DSCG 056 S; DSD 056 L; DSD 056 M; DSD 056 S
Beckhoff	40R	AM3011; AM3012; AM3013; AM3111; AM3112; AM8111; AM8113
Beckhoff	42A	AS1010; AS1020
Beckhoff	55A	AM227L; AM227M; AM8021; AM8022; AM8023; AM8121; AM8122
Beckhoff	58AA	AM3021; AM3022; AM3023; AM3024
Beckhoff	60RB	AM3121
Beckhoff	70AA	AM3031; AM3032; AM3033; AM8031; AM8032; AM8131; AM8531
Beckhoff	84AA	AM3041; AM3042; AM3043; AM3044; AM3541; AM3542; AM3543; AM8041; AM8042; AM8043
Beckhoff	88A	AM247L
Beckhoff	100A	AM257M; AM257S
Beckhoff	104AA	AM8051; AM8052; AM8053
Beckhoff	108AA	AM3051; AM3052; AM3053; AM3054; AM3551; AM3552; AM3553; AM8051-XXXX-900
Beckhoff	158AA	AM3062; AM3063; AM3064; AM3065; AM3562; AM3563; AM8061; AM8062; AM8063

Product range overview

Third-party motors and gear units		
Manufacturer	Motor interface	Type
Bosch Rexroth	38AA	MSM019A; MSM019B
Bosch Rexroth	40G	GTE040
Bosch Rexroth	58AA	MKD 025; MSK030B; MSK030C; MS2N03-BXXXN-AXDK0-NNNNN-NN; MS2N03-BXXXN-BXDG0-NNNNN-NN; MS2N03-BXXXN-BXDH1-NNNNE-NN; MS2N03-BXXXN-CXDG0-NNNNN-NN; MS2N03-BXXXN-CXDG1-NNNNN-NN; MS2N03-BXXXN-CXDH0-NNNNN-NN; MS2N03-BXXXN-CXDH1-NNNNN-NN; MS2N03-BXXXN-CXSG1-NNNNN-
Bosch Rexroth	60H	GTE060
Bosch Rexroth	60P	MSM 031C
Bosch Rexroth	60RA	MSM030B; MSM031B
Bosch Rexroth	68GA	GTM060
Bosch Rexroth	75GA	GTM075
Bosch Rexroth	80G	GTE080
Bosch Rexroth	80P	MSM040B; MSM041B
Bosch Rexroth	82AA	MKD041; MSK040B; MSK040C; MSK043C; MS2N04
Bosch Rexroth	100A	MSK050B; MSK050C
Bosch Rexroth	115GA	GTM100
Bosch Rexroth	116AA	MSK061B; MSK061C
Bosch Rexroth	120G	GTE120
Bosch Rexroth	158AA	MSK070C; MSK070D; MSK070E; MSK071C; MSK071D; MSK071E; MSK075C; MSK075D; MSK075E
Bosch Rexroth	160G	GTE160
Danaher Motion	40R	AKM1 AK; AKM1 AN
Danaher Motion	58AA	AKM21 AC; AKM21 AN; AKM22 AC; AKM22 AN; AKM23 AC; AKM23 AN; AKM24 AC; AKM24 AN; AKM2x AC/AN
Danaher Motion	60P	AKM2 CK
Danaher Motion	70AA	AKM 31 AC; AKM 31 AN; AKM 32 AC; AKM 32 AN; AKM 33 AC; AKM 33 AN
Danaher Motion	84AA	AKM 41 AC; AKM 41 AN; AKM 42 AC; AKM 42 AN; AKM 43 AC; AKM 43 AN; AKM 44 AC; AKM 44 AN
Delta	80RA	ECMA-C Δ0807
Elau	55A	SH-055 80 005; SH-055 80 009; SH-055 80 013
Elau	70A	iSH 070 60 011; iSH 070 60 017; SH-070 60 010; SH-070 60 020; SM-070 xx010; SM-070 xx020
Elau	70AA	iSH 070 60 022; SH-070 60 030
Elau	104AA	SH 100 30 100
Fastech	20AC	EzM2-20
Fastech	25AA	EzM-25
Fastech	28AA	EzM2-28
Fastech	35A	EzM2-35
Fastech	42A	EzM2-42
Fastech	57A	EzM2-56
Fastech	60AA	EzM2-60
Inovance	40R	ISMH1-10B30
Inovance	60PA	ISMH1-20B30; ISMH1-40B30
Inovance	80PA	ISMH1-75B30
Kollmorgen	40R	AKM11; AKM12; AKM13
Kollmorgen	55A	DBL2 H00080
Kollmorgen	58AA	AKM21; AKM22; AKM23; AKM24
Kollmorgen	70AA	AKM31x-Ax; AKM32x-Ax; AKM33x-Ax
Kollmorgen	84AA	AKM41x-Ax; AKM42x-Ax; AKM43x-Ax; AKM44x-Ax
Kollmorgen	108AA	AKM51x-Ax; AKM52x-Ax; AKM53x-Ax; AKM54x-Ax
Kollmorgen	158AA	AKM62; AKM63; AKM64; AKM65
Lenze	68GA	GPA00; MPR050-1S GCN
Lenze	70A	MCS 06; MDSKSxx036
Lenze	75GA	GPA01
Lenze	88A	MCA 10 FF100; MCS 09; MDSKSxx056 FF100
Lenze	115GA	GPA02
Lenze	120GA	GKR03-2M VAK; GKR04-2S VAK
Mitsubishi	28M	HC-AQ0335D
Mitsubishi	40R	HF-KE13; HF-KP053; HF-KP13; HF-MP053; HF-MP13; HG-MR13B
Mitsubishi	60PA	HF-KP23; HF-KP43; HK-KT23W; HK-KT43W; HF-KE23; HF-KE43; HF-MP23; HF-MP43; HG-KR43
Mitsubishi	80PA	HG-KR73; HK-KT7M3W

Product range overview

Third-party motors and gear units		
Manufacturer	Motor interface	Type
Moons	20AB	8HYxx (IP20)
Moons	28AA	MS11HS (IP20)
Moons	35AB	MS14HA (IP20)
Moons	42A	MS17HA (IP20)
Moons	57A	MS23HA (IP20)
Moons	60PA	SM601AE4; SM602AE4
Moons	80PA	SM803AE4
Moons	87AA	ML34HD (IP20)
Neugart	40G	PLE 040; WPLE 40
Neugart	50GA	PLPE 50; WPLPE 50
Neugart	60H	PLE 060; WPLE 60
Neugart	68GA	PLN 70; WPLN 70
Neugart	70GA	PLPE 70; WPLPE 70
Neugart	72GA	PLN 70 (OP14); WPLN 70 (OP14)
Neugart	75GA	PLN 90; WPLN 90
Neugart	80G	PLE 080; WPLE 80
Neugart	90GA	PLPE 90; WPLPE 90
Neugart	115GA	PLN 115; WPLN 115
Neugart	120G	PLE 120; WPLE 120
Neugart	120GA	PLE 080-90; WPLE 80-90
Neugart	120GC	PLPE 120; WPLPE 120
Neugart	160G	PLE 160
Omron	40R	R7M-A10030; R88M-K10030H; SGMAY-01A; SGMAY-A5A; SGMAY-C2A; SGMJV-01A; SGMJV-05A
Omron	60P	R88M-1M40030
Omron	60PA	SGMAH-02; SGMAY-02A; SGMAY-04A; SGMAY-06A; SGMJV-02A; SGMJV-04A
Omron	60RA	R88M-1M20030; R88M-G20030H; R88M-K20030H-S2
Omron	80P	R88M-1M75030; R88M-G75030H; R88M-K75030
Oriental Motor	20AA	CVK21
Oriental Motor	28AA	AR2x; AZ2x; CVK22
Oriental Motor	35AA	CVK23
Oriental Motor	42AA	CVK24
Oriental Motor	42AB	AR4x; AZ4x
Oriental Motor	57A	PKP26
Oriental Motor	57AD	CVK26
Oriental Motor	60AB	AR6x; AZ6x
Oriental Motor	85AA	AR9x; AZ9x
Panasonic	38AA	MSMD012J1; MSMF012; MSMF5A
Panasonic	60P	MSMF042
Panasonic	60RA	MSMF022
Panasonic	80P	MSMF082
Sanyo Denki	28AA	SH2281; SH2285
Sanyo Denki	35A	SH3533; SH3537
Sanyo Denki	40R	R2EA04008; R2xA04005
Sanyo Denki	40S	R2AA04003
Sanyo Denki	40T	R2AA04005; R2AA04010
Sanyo Denki	60PA	R2AA06040; R2AA06040FX; R2xA06020
Sanyo Denki	60S	R2AA06010
Sanyo Denki	60T	R2AA06020
Sanyo Denki	80PB	R2AA08075
Sanyo Denki	90R	R2AAB8100

Product range overview

Third-party motors and gear units		
Manufacturer	Motor interface	Type
Schneider Electric	40A	BMH 1403
Schneider Electric	42A	ILP2R421; ILP2R422; ILP2R423
Schneider Electric	55A	BMH 055; BSH 055
Schneider Electric	57AA	NEMA23; NEMA24
Schneider Electric	57AB	BRS 364; BRS 366; IFS 61; IFS 62; ILS1x571; ILS1x572
Schneider Electric	57AC	BRS 368; IFS 63; ILS1x573
Schneider Electric	70A	BMH 0701; BMH 0702; BSH 0701; BSH 0702
Schneider Electric	70AA	BMH 0703; BSH 0703
Schneider Electric	80G	GBX080
Schneider Electric	104AA	BSH 1004
Schneider Electric	116AA	BRH 110
Schneider Electric	120G	GBX120
SEW Eurodrive	56GA	PSF 121; PSF 122; PSKF 121; PSKF 122
SEW Eurodrive	58AA	CMP40
SEW Eurodrive	68GA	PSC 221; PSC 222; PSF 221; PSF 222; PSKC 221; PSKC 222; PSKF 221; PSKF 222
SEW Eurodrive	70A	CMP50
SEW Eurodrive	70GA	PSCZ 221; PSCZ 222; PSKCZ 221; PSKCZ 222
SEW Eurodrive	75GA	PSC 321; PSC 322; PSF 321; PSF 322; PSKC 321; PSKC 322; PSKF 321; PSKF 322
SEW Eurodrive	88A	CMP63
SEW Eurodrive	92RA	WF10 Ø120; WF10DT56
SEW Eurodrive	100A	CFM71
SEW Eurodrive	115GA	PSC 521; PSC 522; PSF 521; PSF 522; PSKC 521; PSKC 522; PSKF 521; PSKF 522
SEW Eurodrive	120GA	RF07 Ø120; SF37 Ø120; WF30 Ø120; WF37 Ø120
SEW Eurodrive	120GB	RF27 Ø120
SEW Eurodrive	126AA	CMPZ71
SEW Eurodrive	190A	CFM112
Siemens	40R	1FK2102-0AG...; 1FK2102-1AG...
Siemens	40RA	1FK7011; 1FK7015
Siemens	55A	1FK7022; 1FT6021; 1FT6024
Siemens	60PA	1FK2103-2AG...-0...; 1FK2103-2AG...-1...; 1FK2103-4AG...-0...; 1FK2103-4AG...-1...; 1FK2203-2AG...-0...; 1FK2203-2AG...-1...; 1FK2203-4AG...-0...; 1FK2203-4AG...-1...; 1FL603x-2AF21
Siemens	60RB	1FK2103-2AG...-2...; 1FK2103-4AG...-2...; 1FK2203-2AG...-2...; 1FK2203-4AG...-2...
Siemens	68GA	SP 060S
Siemens	70AA	1FT6031; 1FT6034
Siemens	70AB	1FK7032; 1FK7033; 1FK7034; 1FT7034; 6SN2155...
Siemens	75GA	SP 075S
Siemens	80PA	1FK2104-4AK...; 1FK2104-5AK...
Siemens	80RA	1FL604x-2AF21
Siemens	84AA	1FK7040; 1FK7042; 1FK7043; 1FK7044; 1FT6041; 1FT6044; 1FT704x
Siemens	96RB	1FT7042; 1FT7044; 1FT7046
Siemens	115GA	SP 100S
Siemens	120GA	BF29-KQ-703
Siemens	120GB	ZF29-KQ-704; ZF29-KQ-706
Siemens	126AA	1FK7060; 1FK7062; 1FK7063; 1FT6061; 1FT6062; 1FT6064; 1FT7062; 1FT7064; 1FT7066; 1FT7068; 1FK2206
Siemens	158AA	1FK7080; 1FK7083; 1FK7086; 1FT6081; 1FT6082; 1FT6084; 1FT6086

Product range overview

Third-party motors and gear units		
Manufacturer	Motor interface	Type
Wittenstein Alpha	40G	CP 005; CPK 005; alphira CP 040
Wittenstein Alpha	50GA	NPK 005; LP+ 050 (replaced by NP 005); LPK+ 050 (replaced by NPK 005); LK+ 050; LK+ 050; LP+ 050; LPK+ 050; NP 005
Wittenstein Alpha	60H	CP 015; CPK 015; alphira CP 060
Wittenstein Alpha	68GA	SK+ 060; SP+ 060; SPC+ 060; SK+ 060 MF; SP+ 060 MF
Wittenstein Alpha	70GA	NP 015; NPK 015; LP+ 070 (replaced by NP 015); LPK+ 070 (replaced by NPK 015); LK+ 070; LK+ 070; LP+ 070; LPK+ 070
Wittenstein Alpha	75GA	SK+ 075; SP+ 075; SPK+ 075; SPC+ 075; SK+ 075 MF; SP+ 075 MC; SP+ 075 MF; SPK+ 075 MF
Wittenstein Alpha	80G	CP 025; CPK 025; alphira CP 080
Wittenstein Alpha	90GA	NP 025; NPK 025; LP+ 090 (replaced by NP 025); LPK+ 090 (replaced by NPK 025); LK+ 090; LK+ 090; LP+ 090; LPK+ 090
Wittenstein Alpha	115GA	SK+ 100; SP+ 100; SPK+ 100; SPC+ 100; SK+ 100 MF; SP+ 100 MC; SP+ 100 MF; SPK+ 100 MF
Wittenstein Alpha	120G	CP 035; CPK 035; alphira CP 115
Wittenstein Alpha	120GC	NP 035; NPK 035; LP+ 120 (replaced by NP 035); LPK+ 120 (replaced by NPK 035); LK+ 120; LK+ 120; LP+ 120; LPK+ 120
YASKAWA	25A	SGMM...
YASKAWA	40R	SGM7J-A5A.A2.; SGM7J-01A.A2.; SGM7J-C2A.A2.; SGM7JA-A5A.A2.; SGM7JA-01A.A2.; SGM7JA-C2A.A2.
YASKAWA	60PA	SGM7J-02A.A2.; SGM7J-04A.A2.; SGM7J-06A.A2.
YASKAWA	60S	SGM7P-01A..2.
YASKAWA	80PA	SGM7J-08A.A2.

Datasheet

Material:

Coupling housing, coupling hubs, motor flange: Aluminium

Screws: Galvanised steel

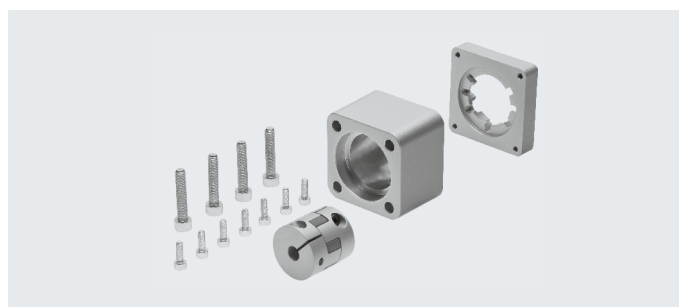

General technical data						
Type	For axis	Transferable torque [Nm]	Mass moment of inertia [kgmm ²]	Max. rotational speed [rpm]	Weight [g]	→ Page
EAMM-A-D19-28A	EGSL	1.1	0.28	10000	80	78
EAMM-A-D19-38AA	EGSL	1.1	0.28	10000	121	
EAMM-A-D19-40A	EGSL	1.1	0.28	10000	110	
EAMM-A-D19-40P	EGSL	1.1	0.28	10000	110	
EAMM-A-D19-40R	EGSL	1.1	0.28	10000	133	
EAMM-A-D19-42A	EGSL	1.1	0.28	10000	130	
EAMM-A-D32-40A	EGSL, ESBF	1.1	0.28	10000	130	
EAMM-A-D32-40G	EGSL, EHMB, ERMB, ESBF	6.5	5.87	8000	420	
EAMM-A-D32-40P	EGSL, ESBF	1.1	0.28	10000	160	
EAMM-A-D32-40R	EGSL, ESBF	6.5	5.87	8000	309	
EAMM-A-D32-40RA	EGSL, ESBF	6.5	5.87	8000	309	
EAMM-A-D32-35A-40A	EHMB, ERMB	4	5.87	8000	220	
EAMM-A-D32-35A-40P	EHMB, ERMB	4	5.87	8000	160	
EAMM-A-D32-42A	EGSL, EHMB, ERMB, ESBF	1.1	0.28	10000	140	
EAMM-A-D32-50GA	EGSL, EHMB, ERMB, ESBF	6.5	5.87	8000	446	
EAMM-A-D32-55A	EGSL, EHMB, ERMB, ESBF	4	5.87	8000	260	
EAMM-A-D32-58AA	EGSL, EHMB, ERMB, ESBF	6.5	5.87	8000	329	
EAMM-A-D32-60AA	EGSL, EHMB, ERMB, ESBF	6.5	5.87	8000	341	
EAMM-A-D32-57A	EGSL, EHMB, ERMB, ESBF	4	5.87	8000	270	
EAMM-A-D32-60G	EGSL, EHMB, ERMB, ESBF	6.5	5.87	8000	540	
EAMM-A-D32-60H	EGSL, EHMB, ERMB, ESBF	6.5	5.87	8000	540	
EAMM-A-D32-60P	EGSL, EHMB, ERMB, ESBF	4	5.87	8000	410	
EAMM-A-D32-60R	EGSL, EHMB, ERMB, ESBF	6.5	5.87	8000	386	
EAMM-A-D32-60RA	EGSL, EHMB, ERMB, ESBF	6.5	5.87	8000	420	
EAMM-A-D40-40G-G2	EGSL, EHMB, ERMB, ESBF	8	5.87	8000	450	
EAMM-A-D40-50GA	EGSL, EHMB, ERMB, ESBF	12.5	5.87	8000	438	
EAMM-A-D40-55A	EGSL, EHMB, ERMB, ESBF	8	5.87	8000	350	
EAMM-A-D40-57A	EGSL, EHMB, ERMB, ESBF	6	5.87	8000	350	
EAMM-A-D40-58AA	EGSL, EHMB, ERMB, ESBF	12.5	5.87	8000	354	
EAMM-A-D40-60AA	EGSL, EHMB, ERMB, ESBF	12.5	5.87	8000	363	
EAMM-A-D40-60G	EGSL, EHMB, ERMB, ESBF	12.5	5.87	8000	570	
EAMM-A-D40-60H	EGSL, EHMB, ERMB, ESBF	12.5	5.87	8000	570	
EAMM-A-D40-60P	EGSL, EHMB, ERMB, ESBF	8	5.87	8000	430	
EAMM-A-D40-60R	EGSL, EHMB, ERMB, ESBF	12.5	5.87	8000	368	
EAMM-A-D40-60RA	EGSL, EHMB, ERMB, ESBF	12.5	5.87	8000	336	
EAMM-A-D40-70AA	EGSL, EHMB, ERMB, ESBF	12.5	5.87	8000	443	
EAMM-A-D40-70A	EGSL, EHMB, ERMB, ESBF	8	5.87	8000	410	
EAMM-A-D40-87A	EGSL, EHMB, ERMB, ESBF	8	5.87	8000	530	
EAMM-A-D50-60G	ESBF	17	34.8	6000	570	
EAMM-A-D50-60H	ESBF	17	34.8	6000	570	
EAMM-A-D50-70A	ESBF	12	34.8	6000	740	
EAMM-A-D50-70GA	ESBF	17	34.8	6000	1018	
EAMM-A-D50-80G	ESBF	17	34.8	6000	1190	

Datasheet

General technical data						
Type	For axis	Transferable torque [Nm]	Mass moment of inertia [kgmm ²]	Max. rotational speed [rpm]	Weight [g]	→ Page
EAMM-A-D50-80P	ESBF	14	34.8	6000	890	78
EAMM-A-D50-80PB	ESBF	17	34.8	6000	892	
EAMM-A-D50-82AA	ESBF	17	34.8	6000	815	
EAMM-A-D50-84AA	ESBF	17	34.8	6000	1012	
EAMM-A-D50-87A	ESBF	12	34.8	6000	860	
EAMM-A-D50-100A	ESBF	14	34.8	6000	1140	
EAMM-A-D60-60G-G2	EGSL, EHMB, ERMB, ESBF	12	34.8	6000	1350	
EAMM-A-D60-60H	EGSL, EHMB, ERMB, ESBF	17	34.8	6000	1250	
EAMM-A-D60-70A	EGSL, EHMB, ERMB, ESBF	12	34.8	6000	750	
EAMM-A-D60-80G	EGSL, EHMB, ERMB, ESBF	17	34.8	6000	1350	
EAMM-A-D60-80P	EGSL, EHMB, ERMB, ESBF	14	34.8	6000	1040	
EAMM-A-D60-80PB	EGSL, EHMB, ERMB, ESBF	21	34.8	6000	1041	
EAMM-A-D60-84AA	EGSL, EHMB, ERMB, ESBF	21	34.8	6000	1173	
EAMM-A-D60-87A	EGSL, EHMB, ERMB, ESBF	12	34.8	6000	890	
EAMM-A-D60-90GA	EGSL, EHMB, ERMB, ESBF	21	34.8	6000	2192	
EAMM-A-D60-92RA	EGSL, EHMB, ERMB, ESBF	21	34.8	6000	1076	
EAMM-A-D60-100A	EGSL, EHMB, ERMB, ESBF	14	34.8	6000	1170	
EAMM-A-D80-80G	ESBF	60	128	5500	1990	
EAMM-A-D80-84AA	ESBF	60	128	5500	1843	
EAMM-A-D80-90GA	ESBF	60	128	550	2192	
EAMM-A-D80-100A	ESBF	60	128	5500	2030	
EAMM-A-D80-150A	ESBF	60	128	5500	3070	
EAMM-A-D100-100A	ESBF	60	128	5500	2450	
EAMM-A-D100-120G	ESBF	143	280	4500	3520	
EAMM-A-D100-150A	ESBF	143	280	4500	3440	
EAMM-A-L27-40G	EGC-TB	2	0.445	10000	180	88
EAMM-A-L27-55A	EGC-TB	2	0.445	10000	220	
EAMM-A-L27-57A	EGC-TB	1.6	0.355	10000	180	
EAMM-A-L27-40A	EGC-TB	1.5	0.355	10000	82	
EAMM-A-L27-40R	EGC-TB	1.6	0.355	10000	110	
EAMM-A-L27-40RA	EGC-TB	1.6	0.355	10000	84	
EAMM-A-L27-42A	EGC-TB	1.2	0.45	10000	157	
EAMM-A-L27-58AA	EGC-TB	2	0.355	10000	165	
EAMM-A-L27-57AA	EGC-TB	1.6	0.355	10000	184	
EAMM-A-L27-57AB	EGC-TB	1.6	0.355	10000	184	
EAMM-A-L27-57AC	EGC-TB	1.6	0.45	10000	183	
EAMM-A-L27-60RA	EGC-TB	2	0.45	10000	278	
EAMM-A-L27-60RB	EGC-TB	2	0.45	10000	221	
EAMM-A-L27-50GA	EGC-TB	2	0.45	10000	197	
EAMM-A-L27-60G	EGC-TB	2	0.45	10000	307	
EAMM-A-L38-55A	EGC-TB, ELGD-TB	4.4	0.445	8000	210	
EAMM-A-L38-57A	EGC-TB, ELGD-TB	3.6	3.2	8000	220	
EAMM-A-L38-60AA	EGC-TB, ELGD-TB	8	3.2	8000	231	
EAMM-A-L38-60G	EGC-TB, ELGD-TB	4.4	3.2	8000	350	
EAMM-A-L38-60H	EGC-TB, ELGD-TB	4.4	3.3	8000	340	
EAMM-A-L38-60P	EGC-TB, ELGD-TB	4.4	3.3	8000	300	
EAMM-A-L38-60R	EGC-TB, ELGD-TB	9	3.2	8000	298	
EAMM-A-L38-70A	EGC-TB, ELGD-TB	4.4	3.2	8000	290	
EAMM-A-L38-87A	EGC-TB, ELGD-TB	4.4	3.2	8000	480	
EAMM-A-L38-58AA	EGC-TB, ELGD-TB	9	3.2	8000	208	

Datasheet

General technical data						
Type	For axis	Transferable torque [Nm]	Mass moment of inertia [kgmm ²]	Max. rotational speed [rpm]	Weight [g]	→ Page
EAMM-A-L38-57AA	EGC-TB, ELGD-TB	8	3.2	8000	221	88
EAMM-A-L38-60PA	EGC-TB, ELGD-TB	9	3.3	8000	301	
EAMM-A-L38-60RB	EGC-TB, ELGD-TB	9	3.2	8000	253	
EAMM-A-L38-70AA	EGC-TB, ELGD-TB	9	3.3	8000	357	
EAMM-A-L38-88A	EGC-TB, ELGD-TB	9	3.3	8000	508	
EAMM-A-L38-84AA	EGC-TB, ELGD-TB	9	4.6	8000	712	
EAMM-A-L38-40G	EGC-TB, ELGD-TB	9	3.2	8000	259	
EAMM-A-L38-50GA	EGC-TB, ELGD-TB	9	3.2	8000	245	
EAMM-A-L38-56GA	EGC-TB, ELGD-TB	9	3.3	8000	275	
EAMM-A-L38-70GA	EGC-TB, ELGD-TB	9	4	8000	457	
EAMM-A-L38-67GA	EGC-TB, ELGD-TB	9	4	8000	363	
EAMM-A-L38-72GA	EGC-TB, ELGD-TB	9	4	8000	480	
EAMM-A-L48-60G	EGC-TB, ELGD-TB	12.5	14.5	8000	490	
EAMM-A-L48-60H	EGC-TB, ELGD-TB	12.5	14.5	8000	430	
EAMM-A-L48-70A	EGC-TB, ELGD-TB	12.5	14.5	8000	350	
EAMM-A-L48-80P-G2	EGC-TB, ELGD-TB	17	39	6000	557	
EAMM-A-L48-87A	EGC-TB, ELGD-TB	12.5	14.5	8000	590	
EAMM-A-L48-100A-G2	EGC-TB, ELGD-TB	17	39	6000	789	
EAMM-A-L48-55A	EGC-TB, ELGD-TB	12.5	14.5	8000	352	
EAMM-A-L48-60PA	EGC-TB, ELGD-TB	12.5	14.5	8000	454	
EAMM-A-L48-70AA	EGC-TB, ELGD-TB	12.5	14.5	8000	498	
EAMM-A-L48-80PB	EGC-TB, ELGD-TB	17	39	8000	560	
EAMM-A-L48-82AA	EGC-TB, ELGD-TB	12.5	14.5	8000	613	
EAMM-A-L48-88A	EGC-TB, ELGD-TB	12.5	14.5	8000	639	
EAMM-A-L48-90R	EGC-TB, ELGD-TB	12.5	14.5	8000	741	
EAMM-A-L48-92RA	EGC-TB, ELGD-TB	12.5	14.5	8000	827	
EAMM-A-L48-84AA	EGC-TB, ELGD-TB	17	39	6000	925	
EAMM-A-L48-40G	EGC-TB, ELGD-TB	12.5	14.5	8000	405	
EAMM-A-L48-50GA	EGC-TB, ELGD-TB	12.5	14.5	8000	394	
EAMM-A-L48-56GA	EGC-TB, ELGD-TB	12.5	14.5	8000	430	
EAMM-A-L48-70GA	EGC-TB, ELGD-TB	12.5	14.5	8000	601	
EAMM-A-L48-75GA	EGC-TB, ELGD-TB	17	39	6000	704	
EAMM-A-L48-80G	EGC-TB, ELGD-TB	17	39	6000	798	
EAMM-A-L48-68GA	EGC-TB, ELGD-TB	12.5	14.5	8000	542	
EAMM-A-L48-72GA	EGC-TB, ELGD-TB	12.5	14.5	8000	623	
EAMM-A-L48-90GA	EGC-TB, ELGD-TB	17	39	6000	675	
EAMM-A-L48-120GA	EGC-TB, ELGD-TB	17	39	6000	656	
EAMM-A-L62-80G	EGC-TB	47	147	5500	1620	
EAMM-A-L62-100A-G2	EGC-TB	47	151	5500	1359	
EAMM-A-L62-150A	EGC-TB	47	151	5500	2526	
EAMM-A-L62-88A	EGC-TB	38	147	5500	977	
EAMM-A-L62-84AA	EGC-TB	60	147	5500	1126	
EAMM-A-L62-108AA	EGC-TB	60	147	5500	2033	
EAMM-A-L62-56GA	EGC-TB	38	147	5500	941	
EAMM-A-L62-60H	EGC-TB	38	147	5500	914	
EAMM-A-L62-70GA	EGC-TB	48	147	5500	935	
EAMM-A-L62-75GA	EGC-TB	60	147	5500	1274	
EAMM-A-L62-68GA	EGC-TB	48	147	5500	1197	
EAMM-A-L62-72GA	EGC-TB	48	147	5500	1259	
EAMM-A-L62-90GA	EGC-TB	60	147	5500	1399	
EAMM-A-L62-115GA	EGC-TB	60	147	5500	2296	
EAMM-A-L62-120G	EGC-TB	47	147	5500	1798	
EAMM-A-L62-120GA	EGC-TB	47	147	5500	1274	

Datasheet

General technical data							
Type	For axis	Transferable torque [Nm]	Mass moment of inertia [kgmm ²]	Max. rotational speed [rpm]	Weight [g]	→ Page	
EAMM-A-L62-120GB	EGC-TB	47	147	5500	1465	88	
EAMM-A-L62-120GC	EGC-TB	47	147	5500	1774		
EAMM-A-L95-80G-G2	ELGA-TB	120	374	4500	2771		
EAMM-A-L95-120G-G2	ELCC-TB, ELGA-TB, EGC-TB	150	374	4500	2935	88	
EAMM-A-L95-150A-G2	ELCC-TB, ELGA-TB, EGC-TB	143	374	4500	3180		
EAMM-A-L95-190A-G2	ELGA-TB, EGC-TB	192	374	4500	4900	88	
EAMM-A-L95-190B-G2	ELGA-TB, EGC-TB	180	402	4500	4500		
EAMM-A-L95-75GA	ELGA-TB, EGC-TB	133	374	4500	3087		
EAMM-A-L95-68GA	ELGA-TB, EGC-TB	93	374	4500	2867		
EAMM-A-L95-72GA	ELGA-TB, EGC-TB	93	374	4500	2867		
EAMM-A-L95-90GA	ELGA-TB, EGC-TB	133	374	4500	2793		
EAMM-A-L95-115GA	ELGA-TB, EGC-TB	192	374	4500	3633		
EAMM-A-L95-120GA	ELGA-TB, EGC-TB	120	374	4500	2635		
EAMM-A-L95-120GB	ELGA-TB, EGC-TB	150	374	4500	3113		
EAMM-A-L95-120GC	ELGA-TB, EGC-TB	192	374	4500	3662		
EAMM-A-L95-160G	ELGA-TB, EGC-TB	192	425	4500	5839		
EAMM-A-M43-60G	EGC-HD-TB	12.5	14.5	8000	340		100
EAMM-A-M43-60H	EGC-HD-TB	12.5	14.5	8000	330		
EAMM-A-M43-55A	EGC-HD-TB	12.5	14.5	8000	254		
EAMM-A-M43-70A	EGC-HD-TB	12.5	14.5	8000	358		
EAMM-A-M43-70AA	EGC-HD-TB	12.5	14.5	8000	375		
EAMM-A-M43-90R	EGC-HD-TB	12.5	14.5	8000	510		
EAMM-A-M43-92RA	EGC-HD-TB	12.5	14.5	8000	687		
EAMM-A-M43-40G	EGC-HD-TB	12.5	14.5	8000	316		
EAMM-A-M43-50GA	EGC-HD-TB	12.5	14.5	8000	296		
EAMM-A-M43-56GA	EGC-HD-TB	12.5	14.5	8000	330		
EAMM-A-M43-70GA	EGC-HD-TB	12.5	14.5	8000	531		
EAMM-A-M43-68GA	EGC-HD-TB	12.5	14.5	8000	361		
EAMM-A-M43-72GA	EGC-HD-TB	12.5	14.5	8000	462		
EAMM-A-M48-60H	EGC-HD-TB	21	39	6000	320		
EAMM-A-M48-80G	EGC-HD-TB	21	39	6000	870		
EAMM-A-M48-88A	EGC-HD-TB	21	39	6000	525		
EAMM-A-M48-84AA	EGC-HD-TB	17	39	6000	711		
EAMM-A-M48-40G	EGC-HD-TB	17	39	6000	347		
EAMM-A-M48-50GA	EGC-HD-TB	17	39	6000	342		
EAMM-A-M48-56GA	EGC-HD-TB	21	39	6000	390		
EAMM-A-M48-60G	EGC-HD-TB	17	39	6000	404		
EAMM-A-M48-70GA	EGC-HD-TB	17	39	6000	493		
EAMM-A-M48-75GA	EGC-HD-TB	17	39	6000	594		
EAMM-A-M48-68GA	EGC-HD-TB	17	39	6000	466		
EAMM-A-M48-72GA	EGC-HD-TB	17	39	6000	517		
EAMM-A-M48-90GA	EGC-HD-TB	17	39	6000	789		
EAMM-A-M48-120GA	EGC-HD-TB	17	39	6000	600		
EAMM-A-M80-120G	EGC-HD-TB	75	147	5500	1370		
EAMM-A-M80-84AA	EGC-HD-TB	60	147	5500	944		
EAMM-A-M80-75GA	EGC-HD-TB	60	147	5500	1011		
EAMM-A-M80-80G	EGC-HD-TB	60	147	5500	771		
EAMM-A-M80-68GA	EGC-HD-TB	48	147	5500	842		
EAMM-A-M80-90GA	EGC-HD-TB	60	172	5500	1177		
EAMM-A-M80-115GA	EGC-HD-TB	60	147	5500	1715		
EAMM-A-M80-120GA	EGC-HD-TB	60	192	5500	1569		
EAMM-A-M80-120GB	EGC-HD-TB	60	147	5500	1744		
EAMM-A-M80-120GC	EGC-HD-TB	60	147	5500	2115		

Datasheet

General technical data						
Type	For axis	Transferable torque [Nm]	Mass moment of inertia [kgmm ²]	Max. rotational speed [rpm]	Weight [g]	→ Page
EAMM-A-N38-60G	ELGA-TB	12.5	14.5	8000	470	88
EAMM-A-N38-60H	ELGA-TB	12.5	14.5	8000	460	
EAMM-A-N38-70A	ELGA-TB	12.5	14.5	8000	430	
EAMM-A-N38-87A	ELGA-TB	12.5	14.5	8000	646	
EAMM-A-N38-60PA	ELGA-TB	12.5	14.5	8000	439	
EAMM-A-N38-60RA	ELGA-TB	12.5	14.5	8000	396	
EAMM-A-N38-70AA	ELGA-TB	12.5	14.5	8000	461	
EAMM-A-N38-88A	ELGA-TB	12.5	14.5	8000	594	
EAMM-A-N38-90R	ELGA-TB	12.5	14.5	8000	716	
EAMM-A-N38-92RA	ELGA-TB	12.5	14.5	8000	810	
EAMM-A-N38-40G	ELGA-TB	12.5	14.5	8000	411	
EAMM-A-N38-50GA	ELGA-TB	12.5	14.5	8000	392	
EAMM-A-N38-56GA	ELGA-TB	12.5	14.5	8000	414	
EAMM-A-N38-70GA	ELGA-TB	12.5	14.5	8000	712	
EAMM-A-N38-68GA	ELGA-TB	12.5	14.5	8000	454	
EAMM-A-N38-72GA	ELGA-TB	12.5	14.5	8000	605	
EAMM-A-N48-60G	ELCC-TB, ELGA-TB, ELGD-TB	12.5	14.5	8000	509	88
EAMM-A-N48-60H	ELCC-TB, ELGA-TB, ELGD-TB	12.5	14.5	8000	470	
EAMM-A-N48-80G	ELCC-TB, ELGA-TB, ELGD-TB	21	39	6000	1080	
EAMM-A-N48-80P	ELCC-TB, ELGD-TB	17	39	6000	852	88
EAMM-A-N48-80PB	ELGA-TB, ELGD-TB	17	39	6000	613	88
EAMM-A-N48-100A	ELCC-TB, ELGA-TB, ELGD-TB	17	39	6000	1070	88
EAMM-A-N48-60PA	ELGA-TB, ELGD-TB	21	39	6000	558	88
EAMM-A-N48-70AA	ELGA-TB, ELGD-TB	21	39	6000	592	
EAMM-A-N48-80P	ELGA-TB, ELGD-TB	17	39	6000	883	
EAMM-A-N48-80PB	ELGA-TB, ELGD-TB	17	39	6000	613	
EAMM-A-N48-88A	ELGA-TB, ELGD-TB	21	39	6000	807	
EAMM-A-N48-84AA	ELGA-TB, ELGD-TB	17	39	6000	1139	
EAMM-A-N48-50GA	ELGA-TB, ELGD-TB	17	39	6000	519	
EAMM-A-N48-56GA	ELGA-TB, ELGD-TB	21	39	6000	577	
EAMM-A-N48-70GA	ELGA-TB, ELGD-TB	17	39	6000	772	
EAMM-A-N48-75GA	ELGA-TB, ELGD-TB	17	39	6000	756	
EAMM-A-N48-68GA	ELGA-TB, ELGD-TB	17	39	6000	627	
EAMM-A-N48-72GA	ELGA-TB, ELGD-TB	17	39	6000	679	
EAMM-A-N48-90GA	ELGA-TB, ELGD-TB	17	39	6000	1279	
EAMM-A-N48-120GA	ELGA-TB, ELGD-TB	17	39	6000	1016	
EAMM-A-N80-80G	ELCC-TB, ELGA-TB	47	147	5500	1290	
EAMM-A-N80-120G	ELGA-TB	47	147	5500	1990	88
EAMM-A-N80-150A	ELCC-TB, ELGA-TB	47	151	5500	2410	88
EAMM-A-N80-84AA	ELGA-TB	47	147	5500	1409	88
EAMM-A-N80-100A	ELGA-TB	47	147	5500	1461	
EAMM-A-N80-70GA	ELGA-TB	48	147	5500	1289	
EAMM-A-N80-75GA	ELGA-TB	47	147	5500	1651	
EAMM-A-N80-68GA	ELGA-TB	48	147	5500	1241	
EAMM-A-N80-72GA	ELGA-TB	48	147	5500	1289	
EAMM-A-N80-90GA	ELGA-TB	47	147	5500	1698	
EAMM-A-N80-115GA	ELGA-TB	47	147	5500	2092	
EAMM-A-N80-120GA	ELGA-TB	47	147	5500	2307	
EAMM-A-N80-120GB	ELGA-TB	47	147	5500	2143	
EAMM-A-N80-120GC	ELGA-TB	47	147	5500	2514	

Datasheet

General technical data						
Type	For axis	Transferable torque [Nm]	Mass moment of inertia [kgmm ²]	Max. rotational speed [rpm]	Weight [g]	→ Page
EAMM-A-S38-40A-G2	EGC-BS, EGC-HD-BS, ELGA-BS	6.5	5.87	8000	270	96
EAMM-A-S38-40G-G2	EGC-BS, EGC-HD-BS, ELGA-BS	6.5	5.87	8000	410	
EAMM-A-S38-40P-G2	EGC-BS, EGC-HD-BS, ELGA-BS	6.5	5.87	8000	280	
EAMM-A-S38-42A-G2	EGC-BS, EGC-HD-BS, ELGA-BS	3.5	5.87	8000	310	
EAMM-A-S38-50GA	EGC-BS, EGC-HD-BS, ELGA-BS	6.5	5.87	8000	362	
EAMM-A-S38-55A-G2	EGC-BS, EGC-HD-BS, ELGA-BS	6.5	5.87	8000	340	
EAMM-A-S38-57A-G2	EGC-BS, EGC-HD-BS, ELGA-BS	6.5	5.87	8000	340	
EAMM-A-S38-58AA	EGC-BS, EGC-HD-BS, ELGA-BS	6.5	5.87	8000	339	
EAMM-A-S38-60AA	EGC-BS, EGC-HD-BS, ELGA-BS	6.5	5.87	8000	365	
EAMM-A-S38-60R	EGC-BS, EGC-HD-BS, ELGA-BS	6.5	5.87	8000	358	
EAMM-A-S38-60RA	EGC-BS, EGC-HD-BS, ELGA-BS	6.5	5.87	8000	401	
EAMM-A-S38-60P-G2	EGC-BS, EGC-HD-BS, ELGA-BS	6.5	5.87	8000	420	
EAMM-A-S48-40G-G2	EGC-BS, EGC-HD-BS, ELGA-BS	12.5	5.87	8000	420	
EAMM-A-S48-50GA	EGC-BS, EGC-HD-BS, ELGA-BS	12.5	5.87	8000	406	
EAMM-A-S48-55A-G2	EGC-BS, EGC-HD-BS, ELGA-BS	12.5	5.87	8000	370	
EAMM-A-S48-57A-G2	EGC-BS, EGC-HD-BS, ELGA-BS	6.5	5.87	8000	570	
EAMM-A-S48-58AA	EGC-BS, EGC-HD-BS, ELGA-BS	12.5	5.87	8000	373	
EAMM-A-S48-60AA	EGC-BS, EGC-HD-BS, ELGA-BS	12.5	5.87	8000	415	
EAMM-A-S48-60G-G2	EGC-BS, EGC-HD-BS, ELGA-BS	12.5	5.87	8000	440	
EAMM-A-S48-60H-G2	EGC-BS, EGC-HD-BS, ELGA-BS	12.5	5.87	8000	430	
EAMM-A-S48-60P-G2	EGC-BS, EGC-HD-BS, ELGA-BS	12.5	5.87	8000	440	
EAMM-A-S48-60R	EGC-BS, EGC-HD-BS, ELGA-BS	12.5	5.87	8000	478	
EAMM-A-S48-RA	EGC-BS, EGC-HD-BS, ELGA-BS	12.5	5.87	8000	476	
EAMM-A-S48-70A-G2	EGC-BS, EGC-HD-BS, ELGA-BS	12.5	5.87	8000	450	
EAMM-A-S48-70AA	EGC-BS, EGC-HD-BS, ELGA-BS	12.5	5.87	8000	498	
EAMM-A-S48-87A-G2	EGC-BS, EGC-HD-BS, ELGA-BS	12.5	5.87	8000	590	
EAMM-A-S62-60G-G2	EGC-BS, EGC-HD-BS, ELGA-BS	21	42.3	6500	1110	
EAMM-A-S62-60H-G2	EGC-BS, EGC-HD-BS, ELGA-BS	21	42.3	6500	1100	
EAMM-A-S62-70A-G2	EGC-BS, EGC-HD-BS, ELGA-BS	17	45.5	6000	1040	
EAMM-A-S62-70GA	EGC-BS, EGC-HD-BS, ELGA-BS	17	34.8	6000	1109	
EAMM-A-S62-80G-G2	EGC-BS, EGC-HD-BS, ELGA-BS	17	34.8	6000	1180	
EAMM-A-S62-80P-G2	EGC-BS, EGC-HD-BS, ELGA-BS	17	34.8	6000	970	
EAMM-A-S62-80PB	EGC-BS, EGC-HD-BS, ELGA-BS	17	34.8	6000	978	
EAMM-A-S62-82AA	EGC-BS, EGC-HD-BS, ELGA-BS	21	34.8	6000	1050	
EAMM-A-S62-84AA	EGC-BS, EGC-HD-BS, ELGA-BS	17	34.8	6000	1037	
EAMM-A-S62-87A-G2	EGC-BS, EGC-HD-BS, ELGA-BS	17	45.5	6000	1150	
EAMM-A-S62-100A-G2	EGC-BS, EGC-HD-BS, ELGA-BS	17	34.8	6000	1240	
EAMM-A-S62-150A-G2	EGC-BS, EGC-HD-BS, ELGA-BS	17	34.8	6000	2160	
EAMM-A-S95-84AA	EGC-BS, EGC-HD-BS, ELGA-BS	60	128	5500	3063	
EAMM-A-S95-90GA	EGC-BS, EGC-HD-BS, ELGA-BS	60	128	5500	3201	
EAMM-A-S95-100A-G2	EGC-BS, EGC-HD-BS, ELGA-BS	60	128	5500	2880	
EAMM-A-S95-150A-G2	EGC-BS, EGC-HD-BS, ELGA-BS	60	128	5500	3770	
EAMM-A-P3-28D-28A	EGSK	0.2	0.28	10000	30	104
EAMM-A-P3-28D-40P	EGSK	0.2	0.28	10000	60	
EAMM-A-P4-28B-28A	EGSK	0.7	0.28	10000	40	
EAMM-A-P4-28B-38AA	EGSK	0.7	0.28	1000	59	
EAMM-A-P4-28B-40A	EGSK	0.7	0.28	10000	50	
EAMM-A-P4-28B-40P	EGSK	0.7	0.28	10000	50	
EAMM-A-P4-28B-40R	EGSK	1.1	0.28	10000	71	
EAMM-A-P4-28B-40RA	EGSK	1.1	0.28	10000	50	
EAMM-A-P4-28B-42A	EGSK	0.7	0.28	10000	60	

Datasheet

General technical data						
Type	For axis	Transferable torque [Nm]	Mass moment of inertia [kgmm ²]	Max. rotational speed [rpm]	Weight [g]	→ Page
EAMM-A-P5-28B-28A	EGSK	1.1	0.28	10000	40	104
EAMM-A-P5-28B-38AA	EGSK	1.1	0.28	10000	59	
EAMM-A-P5-28B-40A	EGSK	1.1	0.28	10000	50	
EAMM-A-P5-28B-40P	EGSK	1.1	0.28	10000	50	
EAMM-A-P5-28B-40R	EGSK	1.1	0.28	10000	71	
EAMM-A-P5-28B-RA	EGSK	1.1	0.28	10000	49	
EAMM-A-P5-28B-42A	EGSK	1.1	0.28	10000	60	
EAMM-A-P6-38A-40A	EGSK	6.5	5.87	8000	100	
EAMM-A-P6-38A-40G	EGSK	6.5	5.87	8000	190	
EAMM-A-P6-38A-40P	EGSK	6.5	5.87	8000	110	
EAMM-A-P6-38A-42A	EGSK	3.5	5.87	8000	160	
EAMM-A-P6-38A-55A	EGSK	6.5	5.87	8000	130	
EAMM-A-P6-38A-57A	EGSK	6.5	5.87	8000	130	
EAMM-A-P6-38A-58AA	EGSK	6.5	5.87	8000	133	
EAMM-A-P6-38A-60P	EGSK	6.5	5.87	8000	210	
EAMM-A-P6-38A-60R	EGSK	6.5	5.87	8000	210	
EAMM-A-P6-38A-60RA	EGSK	6.5	5.87	8000	209	
EAMM-A-P8-38A-40A	EGSK	6.5	5.87	8000	100	
EAMM-A-P8-38A-40G	EGSK	12.5	5.87	8000	190	
EAMM-A-P8-38A-40P	EGSK	12.5	5.87	8000	110	
EAMM-A-P8-38A-42A	EGSK	3.5	5.87	8000	160	
EAMM-A-P8-38A-55A	EGSK	12.5	5.87	8000	130	
EAMM-A-P8-38A-57A	EGSK	6.5	5.87	8000	130	
EAMM-A-P8-38A-58AA	EGSK	12.5	5.87	8000	185	
EAMM-A-P8-38A-60P	EGSK	12.5	5.87	8000	210	
EAMM-A-P8-38A-60AA	EGSK	12.5	5.87	8000	146	
EAMM-A-P8-38A-60R	EGSK	12.5	5.87	8000	145	
EAMM-A-P8-38A-60RA	EGSK	12.5	5.87	8000	149	
EAMM-A-P8-38A-70A	EGSK	12.5	5.87	8000	200	
EAMM-A-P8-38A-87A	EGSK	12.5	5.87	8000	380	
EAMM-A-R27-40G	ELGG, ELGR	2	0.445	10000	240	107
EAMM-A-R27-55A	ELGG, ELGR	2	0.445	10000	170	
EAMM-A-R27-57A	ELGG, ELGR	1.6	0.355	10000	170	
EAMM-A-R38-40G	ELGG, ELGR	9	3.2	8000	330	
EAMM-A-R38-57A	ELGG, ELGR	3.6	3.2	8000	280	
EAMM-A-R38-60P	ELGG, ELGR	4.4	3.3	8000	350	
EAMM-A-R38-60G	ELGG, ELGR	4.4	3.2	8000	390	
EAMM-A-R38-60H	ELGG, ELGR	4.4	3.3	8000	480	
EAMM-A-R38-70A	ELGG, ELGR	4.4	3.2	8000	350	
EAMM-A-R38-87A	ELGG, ELGR	4.4	3.2	8000	530	
EAMM-A-R48-60G	ELGG, ELGR	12.5	14.5	8000	480	
EAMM-A-R48-60H	ELGG, ELGR	12.5	14.5	8000	480	
EAMM-A-R48-70A	ELGG, ELGR	12.5	14.5	8000	450	
EAMM-A-R48-80P	ELGG, ELGR	17	39	6000	710	
EAMM-A-R48-87A	ELGG, ELGR	12.5	14.5	8000	590	
EAMM-A-R48-100A	ELGG, ELGR	17	39	6000	970	

Datasheet

General technical data						
Type	For axis	Transferable torque [Nm]	Mass moment of inertia [kgmm ²]	Max. rotational speed [rpm]	Weight [g]	→ Page
EAMM-A-T42-55A	EGSC, ELGC-BS, ELGC-TB, ELGD-BS	8.5	3.2	8000	328	102
EAMM-A-T42-57A	, ELGD-BSEPCC, EGSC, ELGC-BS, ELGC-TB	6.0	3.2	8000	330	
EAMM-A-T42-58AA	EGSC, ELGC-BS, ELGC-TB, ELGD-BS	8.5	3.2	8000	310	
EAMM-A-T42-60AA	EPCC, EGSC, ELGC-BS, ELGC-TB, ELGD-BS	7.5	3.2	8000	315	
EAMM-A-T42-60AB	EPCC, EGSC, ELGC-BS, ELGC-TB, ELGD-BS	9.5	3.2	8000	314	
EAMM-A-T42-60P	EPCC, EGSC, ELGC-BS, ELGC-TB, ELGD-BS	10	3.2	8000	330	
EAMM-A-T42-60R	EPCC, EGSC, ELGC-BS, ELGC-TB, ELGD-BS	10	3.2	8000	349	
EAMM-A-T42-60RA	EPCC, EGSC, ELGC-BS, ELGC-TB, ELGD-BS	10	3.2	8000	348	
EAMM-A-T42-80P	EPCC, EGSC, ELGC-BS, ELGC-TB, ELGD-BS	10	5.8	8000	500	
EAMM-A-T42-87A	EPCC, EGSC, ELGC-BS, ELGC-TB, ELGD-BS	10	3.2	8000	400	
EAMM-A-T46-60P	ELGC-BS, ELGC-TB, ELGT-BS, ELGD-BS	10	3.2	8000	410	
EAMM-A-T46-60R	ELGC-BS, ELGC-TB, ELGT-BS, ELGD-BS	10	3.2	8000	413	
EAMM-A-T46-60RA	ELGC-BS, ELGC-TB, ELGT-BS, ELGD-BS	10	3.2	8000	412	
EAMM-A-T46-70A	ELGC-BS, ELGC-TB, ELGT-BS, ELGD-BS	10	3.2	8000	574	
EAMM-A-T46-70AA	ELGC-BS, ELGC-TB, ELGT-BS, ELGD-BS	10	3.2	8000	601	
EAMM-A-T46-80P	ELGC-BS, ELGC-TB, ELGT-BS, ELGD-BS	10	5.8	8000	840	
EAMM-A-T46-80PA	ELGC-BS, ELGC-TB, ELGT-BS, ELGD-BS	10	7.5	8000	917	
EAMM-A-T46-80PB	ELGC-BS, ELGC-TB, ELGT-BS, ELGD-BS	10	7.9	8000	923	
EAMM-A-T46-85AA	ELGC-BS, ELGC-TB, ELGT-BS, ELGD-BS	10	3.2	8000	817	
EAMM-A-T46-57A	ELGC-BS, ELGC-TB, ELGT-BS, ELGD-BS	6	3.2	8000	395	
EAMM-A-T46-87A	ELGC-BS, ELGC-TB, ELGT-BS, ELGD-BS	10	3.2	8000	630	
EAMM-A-T46-100A	ELGC-BS, ELGC-TB, ELGT-BS, ELGD-BS	10	5.8	8000	1080	
EAMM-A-V20-28A	EPCC, EGSC	0.2	0.022	10000	27	
EAMM-A-V20-28AA	EPCC, EGSC	0.2	0.022	10000	25	
EAMM-A-V25-38AA	EPCC, EGSC, ELGC-BS	0.5	0.19	10000	94	
EAMM-A-V25-40P	EPCC, EGSC, ELGC-BS	0.5	0.19	10000	90	
EAMM-A-V25-40R	EPCC, EGSC, ELGC-BS	0.5	0.19	10000	107	
EAMM-A-V25-40RA	EPCC, EGSC, ELGC-BS	0.5	0.19	10000	94	
EAMM-A-V25-42A	EPCC, EGSC, ELGC-BS	0.5	0.19	10000	83	
EAMM-A-V25-42AB	EPCC, EGSC, ELGC-BS	0.5	0.19	10000	75	
EAMM-A-V32-38AA	EPCC, EGSC, ELGC-BS, ELGC-TB	1.5	0.18	10000	112	
EAMM-A-V32-40P	EPCC, EGSC, ELGC-BS, ELGC-TB	1.5	0.19	10000	110	
EAMM-A-V32-40R	EPCC, EGSC, ELGC-BS, ELGC-TB	1.5	0.19	10000	131	
EAMM-A-V32-40RA	EPCC, EGSC, ELGC-BS, ELGC-TB	1.5	0.19	10000	114	
EAMM-A-V32-42A	EPCC, EGSC, ELGC-BS, ELGC-TB	1.0	0.19	10000	120	
EAMM-A-V32-42AB	EPCC, EGSC, ELGC-BS, ELGC-TB	1.0	0.19	10000	130	
EAMM-A-V32-57A	EPCC, EGSC, ELGC-BS, ELGC-TB	1.5	0.19	10000	180	
EAMM-A-V32-58AA	EPCC, EGSC, ELGC-BS, ELGC-TB	1.5	1.06	10000	1192	
EAMM-A-V32-60AA	EPCC, EGSC, ELGC-BS, ELGC-TB	1.5	0.19	10000	203	
EAMM-A-V32-60P	EPCC, EGSC, ELGC-BS, ELGC-TB	1.5	1.00	10000	210	
EAMM-A-V32-60PA	EPCC, EGSC, ELGC-BS, ELGC-TB	1.5	1.00	10000	243	
EAMM-A-V32-60RA	EPCC, EGSC, ELGC-BS, ELGC-TB	1.5	1.00	10000	243	
EAMM-A-X48-57A	EXCM, EXCH	7.5	6.1	8000	614	109
EAMM-A-X48-80P	EXCM, EXCH	17	34.8	6000	821	
EAMM-A-X62-100A	EXCH	47	151	5500	1428	
EAMM-A-X62-150A	EXCH	47	151	5500	2340	
EAMM-A-Y62-100A	EXCT	17	39	6000	1047	109

Datasheet

Operating and environmental conditions		
Ambient temperature	[°C]	-10 ... +60
Storage temperature	[°C]	-25 ... +60
Degree of protection ¹⁾		
EAMM-A-...		IP40
EAMM-A-...S1		IP65
Relative humidity	[%]	0 ... 95
Corrosion resistance class CRC ²⁾		1
Note on materials		RoHS-compliant
LABS (PWIS) conformity		
EAMM-A-...		VDMA24364-B2-L
EAMM-A-D19-...		VDMA24364 zone III
EAMM-A-D-...S1		VDMA24364 zone III

1) Only in combination with attached motor and axis

2) Corrosion resistance class CRC 1 to Festo standard FN 940070

Low corrosion stress. Dry indoor applications or transport and storage protection. Also applies to parts behind covers, in the non-visible interior area, or parts that are covered in the application (e.g. drive trunnions).

Datasheet

Dimensions (sample illustration)

Download CAD data → www.festo.com

EGSL...

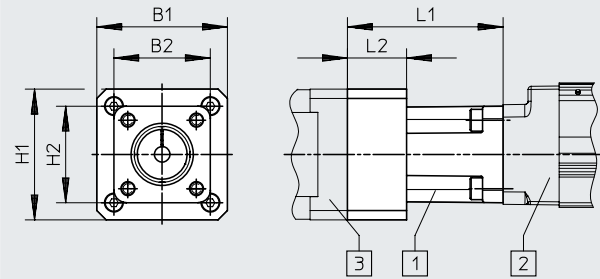

Main illustration:

- [1] Axial kit
- [2] Mini slide
- [3] Motor

ESBF... with degree of protection IP40

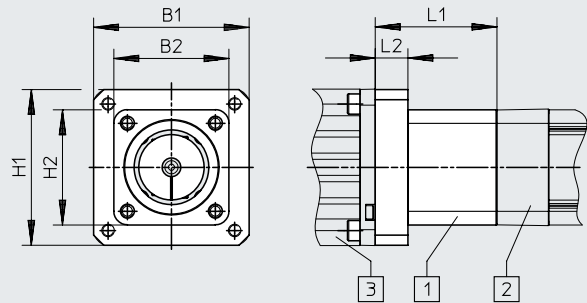

Main illustration:

- [1] Axial kit
- [2] Electric cylinder
- [3] Motor

ERMB...

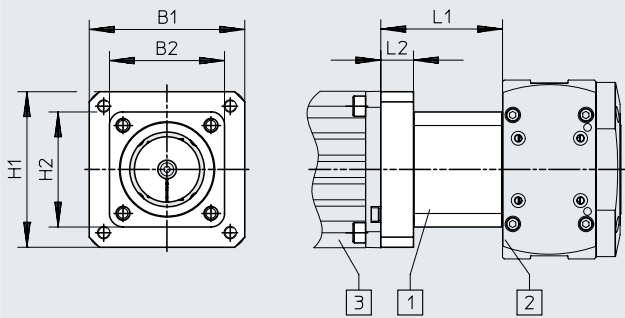

Main illustration:

- [1] Axial kit
- [2] Rotary module
- [3] Motor

EHMB...

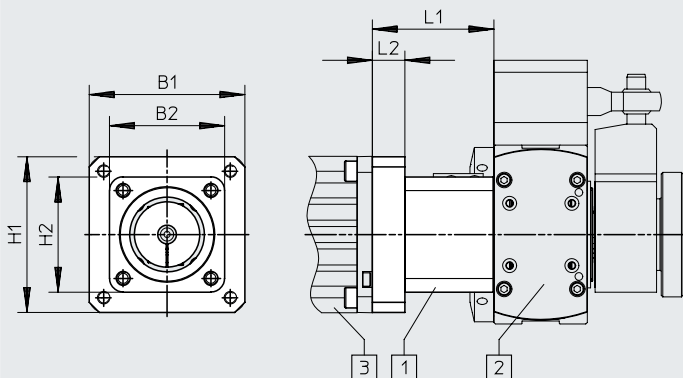

Main illustration:

- [1] Axial kit
- [2] Rotary/lifting module
- [3] Motor

Datasheet

Type	B1	B2	H1	H2	L1	L2
EAMM-A-D19-28A	30	31	30	31	46.2	15
EAMM-A-D19-38AA	38	31	38	31	51.2	20
EAMM-A-D19-40A	40	31	40	31	42.7	11.5
EAMM-A-D19-40P	39.7	31	39.7	31	45.7	14.5
EAMM-A-D19-40R	40	31	40	31	51.2	20
EAMM-A-D19-42A	42	31	42	31	50	19
EAMM-A-D32-35A-40A	40	40	40	40	46	–
EAMM-A-D32-35A-40P	39.7	39.7	39.7	39.7	49.5	–
EAMM-A-D32-40A	40	45	40	45	39.8	8.3
EAMM-A-D32-40G	60	45	60	45	62.5	24
EAMM-A-D32-40P	39.7	45	39.7	45	44	12.5
EAMM-A-D32-40R	53.5	45	53.5	45	49.8	11.1
EAMM-A-D32-42A	42	45	42	45	48	5
EAMM-A-D32-50GA	62	45	62	45	62.5	31.5
EAMM-A-D32-55A	55	45	55	45	49.2	10.5
EAMM-A-D32-57A	56.4	45	56.4	45	50.5	12
EAMM-A-D32-58AA	58	45	58	45	51.2	12.5
EAMM-A-D32-60AA	60	45	60	45	50.7	12
EAMM-A-D32-60G	75	45	75	45	66.5	28
EAMM-A-D32-60H	75	45	75	45	66.5	28
EAMM-A-D32-60P	61.4	45	61.4	45	59.7	21
EAMM-A-D32-60R	62	45	62	45	51	20
EAMM-A-D32-60RA	62	45	62	45	51	20
EAMM-A-D40-40G-G2	60	54	60	54	62.5	24
EAMM-A-D40-50GA	62	54	62	54	62.5	31.5
EAMM-A-D40-55A	55	54	55	54	49.2	10.5
EAMM-A-D40-57A	56.4	54	56.4	54	50.5	12
EAMM-A-D40-58AA	58	54	58	54	51.2	12.5
EAMM-A-D40-60AA	60	54	60	54	50.7	12
EAMM-A-D40-60G	75	54	75	54	66.5	28
EAMM-A-D40-60H	75	54	75	54	66.5	28
EAMM-A-D40-60P	61.4	54	61.4	54	59.7	21
EAMM-A-D40-60R	62	54	62	54	51	20
EAMM-A-D40-60RA	62	54	62	54	51	20
EAMM-A-D40-70A	70	54	70	54	52	13.5
EAMM-A-D40-70AA	72	54	72	54	53.5	13
EAMM-A-D40-87A	85.8	54	85.8	54	54	15.5

Datasheet

Dimensions (sample illustration)

Download CAD data → www.festo.com

EGSL...

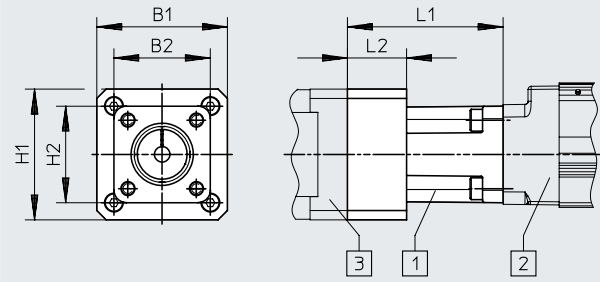

Main illustration:

- [1] Axial kit
- [2] Mini slide
- [3] Motor

ESBF... with degree of protection IP40

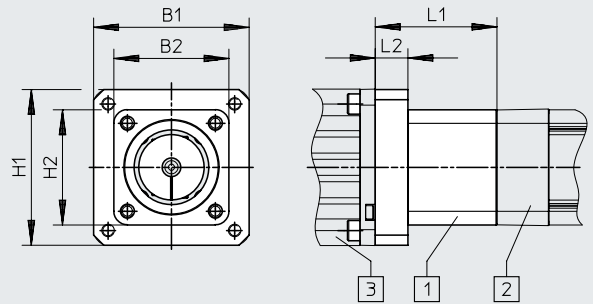

Main illustration:

- [1] Axial kit
- [2] Electric cylinder
- [3] Motor

ERMB...

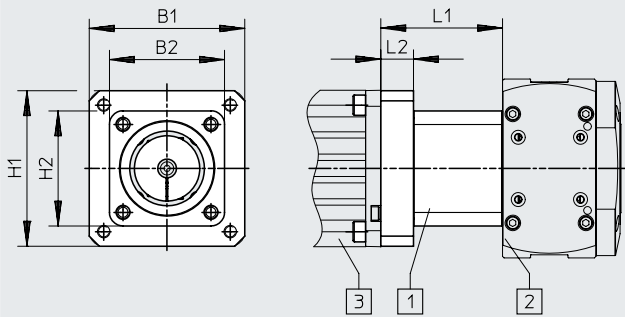

Main illustration:

- [1] Axial kit
- [2] Rotary module
- [3] Motor

EHMB...

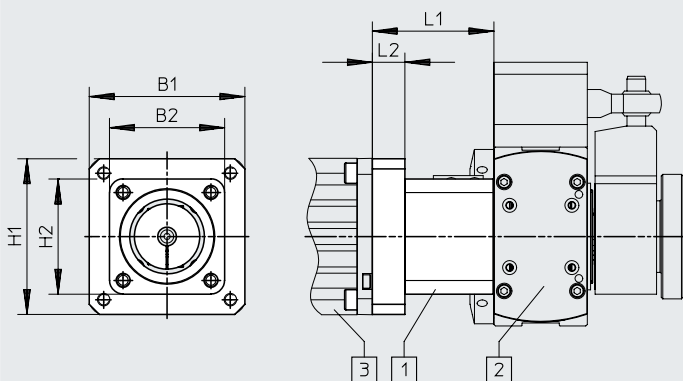

Main illustration:

- [1] Axial kit
- [2] Rotary/lifting module
- [3] Motor

Datasheet

Type	B1	B2	H1	H2	L1	L2
EAMM-A-D50-60G	90	74	90	74	87.4	35
EAMM-A-D50-60H	90	74	90	74	87.4	35
EAMM-A-D50-70A	70	74	70	74	68.2	16.2
EAMM-A-D50-70GA	85.8	65	85.8	65	83.7	31.5
EAMM-A-D50-80G	104	74	104	74	92.4	30
EAMM-A-D50-80P	81.3	74	81.3	74	79.7	17.5
EAMM-A-D50-80PB	81.3	65	81.3	65	79.7	17.5
EAMM-A-D50-82AA	82	65	82	65	68.2	16
EAMM-A-D50-84AA	96	65	96	65	79.7	17.5
EAMM-A-D50-87A	85.8	74	85.8	74	69.7	17.5
EAMM-A-D50-100A	100	74	100	74	83.2	21
EAMM-A-D60-60G-G2	90	74	90	74	82.4	35
EAMM-A-D60-60H	90	74	90	74	82.4	35
EAMM-A-D60-70A	70	74	70	74	64.2	16
EAMM-A-D60-80G	104	74	104	74	87.4	30
EAMM-A-D60-80P	81.3	74	81.3	74	74.7	17.5
EAMM-A-D60-80PB	81.3	74	81.3	74	74.7	17.5
EAMM-A-D60-84AA	96	74	96	74	74.7	17.5
EAMM-A-D60-92RA	90	74	90	74	75	28
EAMM-A-D60-87A	85.8	74	85.8	74	64.7	17.5
EAMM-A-D60-90GA	104	75	104	75	93.9	38.5
EAMM-A-D60-100A	100	74	100	74	79.2	21
EAMM-A-D80-80G	104	100	104	100	102	30
EAMM-A-D80-84AA	100	100	100	100	85.2	13
EAMM-A-D80-90GA	104	100	104	100	108.5	36.5
EAMM-A-D80-100A	100	100	100	100	92	20
EAMM-A-D80-150A	151	100	151	100	102	30
EAMM-A-D100-100A	100	112	100	112	99.5	20
EAMM-A-D100-120G	143	112	143	112	113.5	34
EAMM-A-D100-150A	151	109	151	109	102	30

Datasheet

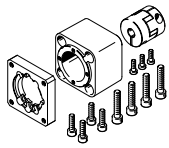
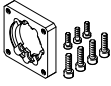
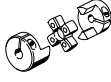
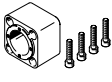
Ordering data – Individual components			
Axial kit	Consisting of:		
	Motor flange	Coupling	Coupling housing
			
Part no. Type	Part no. Type	Part no. Type	Part no. Type
1081659 EAMM-A-D19-28A	1087613 EAMF-A-28D-28A	562676 EAMC-16-20-5-5	1087585 EAMK-A-D19-28D
1199152 EAMM-A-D19-40A	1199144 EAMF-A-28D-40A	543419 EAMC-16-20-5-6	1087585 EAMK-A-D19-28D
1981953 EAMM-A-D19-40P	1982014 EAMF-A-28D-40P	562677 EAMC-16-20-5-8	1087585 EAMK-A-D19-28D
1087642 EAMM-A-D19-42A	1087630 EAMF-A-28D-42A	562676 EAMC-16-20-5-5	1087585 EAMK-A-D19-28D
560281 EAMM-A-D32-35A-40A	–	558312 EAMC-30-32-6-6	560280 EAMK-A-D32-35A-40A
2207441 EAMM-A-D32-35A-40P	–	533708 EAMC-30-32-6-8	2207509 EAMK-A-D32-35A-40P
543147 EAMM-A-D32-40A	552163 EAMF-A-28B-40A	543420 EAMC-16-20-6-6	552155 EAMK-A-D32-28B
1454238 EAMM-A-D32-40G	1460095 EAMF-A-44C-40G-S1	562681 EAMC-30-32-6-10	551006 EAMK-A-D32-44A/C
★ 1976465 EAMM-A-D32-40P	1976704 EAMF-A-28B-40P	1232854 EAMC-16-20-6-8	552155 EAMK-A-D32-28B
★ 543148 EAMM-A-D32-42A	552164 EAMF-A-28B-42A	543419 EAMC-16-20-5-6	552155 EAMK-A-D32-28B
550979 EAMM-A-D32-55A	529942 EAMF-A-44A/B-55A	551003 EAMC-30-32-6-9	551006 EAMK-A-D32-44A/C
★ 550980 EAMM-A-D32-57A	530081 EAMF-A-44A/B-57A	551002 EAMC-30-32-6-6.35	551006 EAMK-A-D32-44A/C
2946758 EAMM-A-D32-60G	1460105 EAMF-A-44C-60G/H-S1	318577 EAMC-30-32-6-11	551006 EAMK-A-D32-44A/C
2946760 EAMM-A-D32-60H	1460105 EAMF-A-44C-60G/H-S1	1233256 EAMC-30-32-6-14	551006 EAMK-A-D32-44A/C
★ 1956054 EAMM-A-D32-60P	1956846 EAMF-A-44C-60P	1233256 EAMC-30-32-6-14	551006 EAMK-A-D32-44A/C

Festo Core Range



Generally ready for shipping ex works in 24 hours
 Generally ready for shipping ex works in 5 days

Datasheet

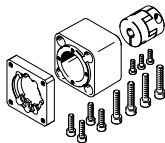
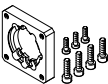
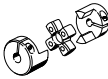
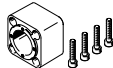
Ordering data – Individual components			
Axial kit	Consisting of:		
	Motor flange	Coupling	Coupling housing
			
Part no. Type	Part no. Type	Part no. Type	Part no. Type
2256398 EAMM-A-D40-40G-G2	1460095 EAMF-A-44C-40G-S1	558029 EAMC-30-32-8-10	552157 EAMK-A-D40-44A/C
543153 EAMM-A-D40-55A	529942 EAMF-A-44A/B-55A	543423 EAMC-30-32-8-9	552157 EAMK-A-D40-44A/C
★ 543154 EAMM-A-D40-57A	530081 EAMF-A-44A/B-57A	543421 EAMC-30-32-6.35-8	552157 EAMK-A-D40-44A/C
2256400 EAMM-A-D40-60G	1460105 EAMF-A-44C-60G/H-S1	551004 EAMC-30-32-8-11	552157 EAMK-A-D40-44A/C
1454242 EAMM-A-D40-60H	1460105 EAMF-A-44C-60G/H-S1	562682 EAMC-30-32-8-14	552157 EAMK-A-D40-44A/C
★ 1977000 EAMM-A-D40-60P	1956846 EAMF-A-44C-60P	562682 EAMC-30-32-8-14	552157 EAMK-A-D40-44A/C
550981 EAMM-A-D40-70A	529943 EAMF-A-44A/B-70A	551004 EAMC-30-32-8-11	552157 EAMK-A-D40-44A/C
★ 550982 EAMM-A-D40-87A	530082 EAMF-A-44A/B-87A	551004 EAMC-30-32-8-11	552157 EAMK-A-D40-44A/C
2733786 EAMM-A-D50-60G	2256289 EAMF-A-64B-60G/H-S1	543424 EAMC-42-50-11-12	2733780 EAMK-A-D50-64B
2733796 EAMM-A-D50-60H	2256289 EAMF-A-64B-60G/H-S1	1455671 EAMC-42-50-12-14	2733780 EAMK-A-D50-64B
2733783 EAMM-A-D50-70A	529945 EAMF-A-64A/B-70A	543424 EAMC-42-50-11-12	2733780 EAMK-A-D50-64B
2733787 EAMM-A-D50-80G	2843290 EAMF-A-64C-80G-S1	2138701 EAMC-42-50-12-20	2836865 EAMK-A-D50-64C
★ 2733785 EAMM-A-D50-80P	1977113 EAMF-A-64A/C-80P	551005 EAMC-42-50-12-19	2836865 EAMK-A-D50-64C
★ 2733781 EAMM-A-D50-87A	533140 EAMF-A-64A/B-87A	543424 EAMC-42-50-11-12	2733780 EAMK-A-D50-64B
★ 2733784 EAMM-A-D50-100A	529947 EAMF-A-64A/C/D-100A	551005 EAMC-42-50-12-19	2836865 EAMK-A-D50-64C

Festo Core Range



Generally ready for shipping ex works in 24 hours



Generally ready for shipping ex works in 5 days

Datasheet

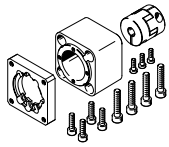
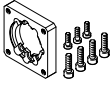
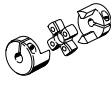
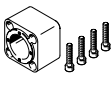
Ordering data – Individual components			
Axial kit	Consisting of:		
	Motor flange	Coupling	Coupling housing
			
Part no. Type	Part no. Type	Part no. Type	Part no. Type
2256696 EAMM-A-D60-60G-G2	2256289 EAMF-A-64B-60G/H-S1	543424 EAMC-42-50-11-12	552160 EAMK-A-D60-64B
1454245 EAMM-A-D60-60H	2256289 EAMF-A-64B-60G/H-S1	1455671 EAMC-42-50-12-14	552160 EAMK-A-D60-64B
543161 EAMM-A-D60-70A	529945 EAMF-A-64A/B-70A	543424 EAMC-42-50-11-12	552160 EAMK-A-D60-64B
1499402 EAMM-A-D60-80G	2843290 EAMF-A-64C-80G-S1	2138701 EAMC-42-50-12-20	551007 EAMK-A-D60-64C
★ 1977073 EAMM-A-D60-80P	1977113 EAMF-A-64A/C-80P	551005 EAMC-42-50-12-19	551007 EAMK-A-D60-64C
★ 543162 EAMM-A-D60-87A	533140 EAMF-A-64A/B-87A	543424 EAMC-42-50-11-12	552160 EAMK-A-D60-64B
★ 550983 EAMM-A-D60-100A	529947 EAMF-A-64A/C/D-100A	551005 EAMC-42-50-12-19	551007 EAMK-A-D60-64C
2946763 EAMM-A-D80-80G	2933286 EAMF-A-77A-80G-S1	3181801 EAMC-56-58-19-20	1593627 EAMK-A-D80-77A
1589665 EAMM-A-D80-100A	1593628 EAMF-A-77A-100A	1485673 EAMC-56-58-19-19	1593627 EAMK-A-D80-77A
8157273 EAMM-A-D80-150A	–	1485674 EAMC-56-58-19-24	8159894 EAMK-A-D80-150A
3356796 EAMM-A-D100-100A	1593628 EAMF-A-77A-100A	1485674 EAMC-56-58-19-24	1593914 EAMK-A-D100-77A/B
2449341 EAMM-A-D100-120G	2449380 EAMF-A-77B-120G-S1	3187895 EAMC-67-62-24-25	1593914 EAMK-A-D100-77A/B
8157275 EAMM-A-D100-150A	–	1451407 EAMC-67-62-24-24	8159895 EAMK-A-D100-150A

Datasheet

Dimensions (sample illustration)

Download CAD data → www.festo.com

ESBF... with degree of protection IP65

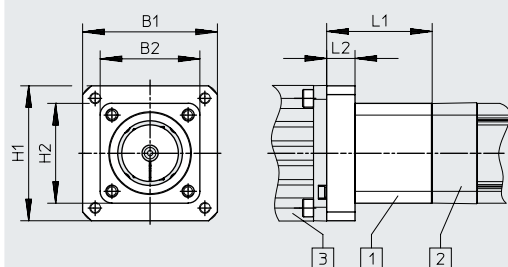

Main illustration:

- [1] Axial kit
- [2] Electric cylinder
- [3] Motor

Type	B1	B2	H1	H2	L1	L2
EAMM-A-D32-40A-S1	40	45	40	45	41.3	8.8
EAMM-A-D32-40G-S1	60	45	60	45	62.5	24
EAMM-A-D32-40P-S1	39.7	45	39.7	45	45.5	13
EAMM-A-D32-42A-S1	42	45	42	45	49.5	5.5
EAMM-A-D32-55A-S1	55	45	55	45	50.7	11
EAMM-A-D32-57A-S1	56.4	45	56.4	45	52	12.5
EAMM-A-D32-60G-S1	75	45	75	45	67.5	28.5
EAMM-A-D32-60H-S1	75	45	75	45	67.5	28.5
EAMM-A-D32-60P-S1	61.4	45	61.4	45	60.7	21
EAMM-A-D40-40G-S1	60	54	60	54	63.5	24.5
EAMM-A-D40-55A-S1	55	54	55	54	50.7	11
EAMM-A-D40-57A-S1	56.4	54	56.4	54	52	12.5
EAMM-A-D40-60G-S1	75	54	75	54	67.5	28.5
EAMM-A-D40-60H-S1	75	54	75	54	67.5	28.5
EAMM-A-D40-60P-S1	61.4	54	61.4	54	61.2	22
EAMM-A-D40-70A-S1	70	54	70	54	53	14
EAMM-A-D40-87A-S1	85.8	54	85.8	54	55	16
EAMM-A-D50-60G-S1	90	74	90	74	88.4	35.5
EAMM-A-D50-60H-S1	90	74	90	74	88.4	35.5
EAMM-A-D50-70A-S1	70	74	70	74	69.2	16.5
EAMM-A-D50-80G-S1	104	74	104	74	93.4	30.5
EAMM-A-D50-80P-S1	81.3	74	81.3	74	80.7	18
EAMM-A-D50-87A-S1	85.8	74	85.8	74	70.7	18
EAMM-A-D50-100A-S1	100	74	100	74	84.2	21.5
EAMM-A-D60-60G-S1	90	74	90	74	83.4	35.5
EAMM-A-D60-60H-S1	90	74	90	74	83.4	35.5
EAMM-A-D60-70A-S1	70	74	70	74	64.2	16.5
EAMM-A-D60-80G-S1	104	74	104	74	88.4	30.5
EAMM-A-D60-80P-S1	81.3	74	81.3	74	75.7	18
EAMM-A-D60-87A-S1	85.8	74	85.8	74	66.5	18
EAMM-A-D60-100A-S1	100	74	100	74	79.2	21.5
EAMM-A-D80-80G-S1	104	100	104	100	103.5	30.5
EAMM-A-D80-100A-S1	100	100	100	100	93.5	20.5
EAMM-A-D80-150A-S1	151	100	151	100	103	30.5
EAMM-A-D100-100A-S1	100	112	100	112	101	20
EAMM-A-D100-120G-S1	143	112	143	112	115	34.5
EAMM-A-D100-150A-S1	151	109	151	109	103	30.5

Datasheet

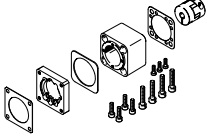
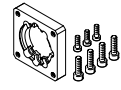
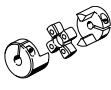
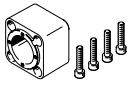
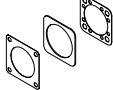
Ordering data – Individual components				
Axial kit	Consisting of:			
	Motor flange	Coupling	Coupling housing	Seal set
				
Part no. Type	Part no. Type	Part no. Type	Part no. Type	Part no. Type
1322178 EAMM-A-D32-40A-S1	552163 EAMF-A-28B-40A	543420 EAMC-16-20-6-6	552155 EAMK-A-D32-28B	1561526 EADS-F-D32-40A
2256396 EAMM-A-D32-40G-S1	1460095 EAMF-A-44C-40G-S1	562681 EAMC-30-32-6-10	551006 EAMK-A-D32-44A/C	2253500 EADS-F-D32-40G
2207372 EAMM-A-D32-40P-S1	1976704 EAMF-A-28B-40P	1232854 EAMC-16-20-6-8	552155 EAMK-A-D32-28B	2207219 EADS-F-D32-40P
1322179 EAMM-A-D32-42A-S1	552164 EAMF-A-28B-42A	543419 EAMC-16-20-5-6	552155 EAMK-A-D32-28B	1561527 EADS-F-D32-42A
1322180 EAMM-A-D32-55A-S1	529942 EAMF-A-44A/B-55A	551003 EAMC-30-32-6-9	551006 EAMK-A-D32-44A/C	1561528 EADS-F-D32-55A
1322181 EAMM-A-D32-57A-S1	530081 EAMF-A-44A/B-57A	551002 EAMC-30-32-6-6.35	551006 EAMK-A-D32-44A/C	1561529 EADS-F-D32-57A
2946759 EAMM-A-D32-60G-S1	1460105 EAMF-A-44C-60G/H-S1	3187577 EAMC-30-32-6-11	551006 EAMK-A-D32-44A/C	8022150 EADS-F-D32-60G/H
2946761 EAMM-A-D32-60H-S1	1460105 EAMF-A-44C-60G/H-S1	1233256 EAMC-30-32-6-14	551006 EAMK-A-D32-44A/C	8022150 EADS-F-D32-60G/H
2234020 EAMM-A-D32-60P-S1	1956846 EAMF-A-44C-60P	1233256 EAMC-30-32-6-14	551006 EAMK-A-D32-44A/C	2234012 EADS-F-D32-60P
2256399 EAMM-A-D40-40G-S1	1460095 EAMF-A-44C-40G-S1	558029 EAMC-30-32-8-10	552157 EAMK-A-D40-44A/C	2253502 EADS-F-D40-40G
1322182 EAMM-A-D40-55A-S1	529942 EAMF-A-44A/B-55A	543423 EAMC-30-32-8-9	552157 EAMK-A-D40-44A/C	1561530 EADS-F-D40-55A
1322183 EAMM-A-D40-57A-S1	530081 EAMF-A-44A/B-57A	543421 EAMC-30-32-6.35-8	552157 EAMK-A-D40-44A/C	1561531 EADS-F-D40-57A
2256409 EAMM-A-D40-60G-S1	1460105 EAMF-A-44C-60G/H-S1	551004 EAMC-30-32-8-11	552157 EAMK-A-D40-44A/C	2253503 EADS-F-D40-60G/H
2256401 EAMM-A-D40-60H-S1	1460105 EAMF-A-44C-60G/H-S1	562682 EAMC-30-32-8-14	552157 EAMK-A-D40-44A/C	2253503 EADS-F-D40-60G/H
2151519 EAMM-A-D40-60P-S1	1956846 EAMF-A-44C-60P	562682 EAMC-30-32-8-14	552157 EAMK-A-D40-44A/C	2151545 EADS-F-D40-60P
1322185 EAMM-A-D40-70A-S1	529943 EAMF-A-44A/B-70A	551004 EAMC-30-32-8-11	552157 EAMK-A-D40-44A/C	1561532 EADS-F-D40-70A
1322186 EAMM-A-D40-87A-S1	530082 EAMF-A-44A/B-87A	551004 EAMC-30-32-8-11	552157 EAMK-A-D40-44A/C	1561533 EADS-F-D40-87A

Datasheet

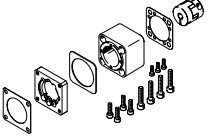
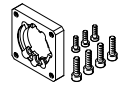
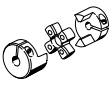
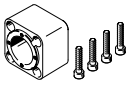
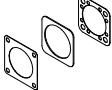
Ordering data – Individual components				
Axial kit	Consisting of:			
	Motor flange	Coupling	Coupling housing	Seal set
				
Part no. Type	Part no. Type	Part no. Type	Part no. Type	Part no. Type
2734290 EAMM-A-D50-60G-S1	2256289 EAMF-A-64B-60G/H-S1	543424 EAMC-42-50-11-12	2733780 EAMK-A-D50-64B	2733792 EADS-F-D50-60G/H
2907418 EAMM-A-D50-60H-S1	2256289 EAMF-A-64B-60G/H-S1	1455671 EAMC-42-50-12-14	2733780 EAMK-A-D50-64B	2733792 EADS-F-D50-60G/H
2734287 EAMM-A-D50-70A-S1	529945 EAMF-A-64A/B-70A	543424 EAMC-42-50-11-12	2733780 EAMK-A-D50-64B	2733789 EADS-F-D50-70A
2734291 EAMM-A-D50-80G-S1	2843290 EAMF-A-64C-80G-S1	2138701 EAMC-42-50-12-20	2836865 EAMK-A-D50-64C	2733793 EADS-F-D50-80G
2734289 EAMM-A-D50-80P-S1	1977113 EAMF-A-64A/C-80P	551005 EAMC-42-50-12-19	2836865 EAMK-A-D50-64C	2733791 EADS-F-D50-80P
2734286 EAMM-A-D50-87A-S1	533140 EAMF-A-64A/B-87A	543424 EAMC-42-50-11-12	2733780 EAMK-A-D50-64B	2733788 EADS-F-D50-87A
2734288 EAMM-A-D50-100A-S1	529947 EAMF-A-64A/C/D-100A	551005 EAMC-42-50-12-19	2836865 EAMK-A-D50-64C	2733790 EADS-F-D50-100A
2256698 EAMM-A-D60-60G-S1	2256289 EAMF-A-64B-60G/H-S1	543424 EAMC-42-50-11-12	552160 EAMK-A-D60-64B	2253505 EADS-F-D60-60G/H
2256697 EAMM-A-D60-60H-S1	2256289 EAMF-A-64B-60G/H-S1	1455671 EAMC-42-50-12-14	552160 EAMK-A-D60-64B	2253505 EADS-F-D60-60G/H
2256699 EAMM-A-D60-70A-S1	529945 EAMF-A-64A/B-70A	543424 EAMC-42-50-11-12	552160 EAMK-A-D60-64B	8022145 EADS-F-D60-70A
2946762 EAMM-A-D60-80G-S1	2843290 EAMF-A-64C-80G-S1	2138701 EAMC-42-50-12-20	551007 EAMK-A-D60-64C	8022146 EADS-F-D60-80G
2218564 EAMM-A-D60-80P-S1	1977113 EAMF-A-64A/C-80P	551005 EAMC-42-50-12-19	551007 EAMK-A-D60-64C	2218523 EADS-F-D60-80P
1322188 EAMM-A-D60-87A-S1	533140 EAMF-A-64A/B-87A	543424 EAMC-42-50-11-12	552160 EAMK-A-D60-64B	1561536 EADS-F-D60-87A
2256700 EAMM-A-D60-100A-S1	529947 EAMF-A-64A/C/D-100A	551005 EAMC-42-50-12-19	551007 EAMK-A-D60-64C	2253507 EADS-F-D60-100A
2946764 EAMM-A-D80-80G-S1	2933286 EAMF-A-77A-80G-S1	3181801 EAMC-56-58-19-20	1593627 EAMK-A-D80-77A	8022147 EADS-F-D80-80G
1600673 EAMM-A-D80-100A-S1	1593628 EAMF-A-77A-100A	1485673 EAMC-56-58-19-19	1593627 EAMK-A-D80-77A	1593617 EADS-F-D80-100A
8157274 EAMM-A-D80-150A-S1	–	1485674 EAMC-56-58-19-24	8159894 EAMK-A-D80-150A	8162067 EADS-F-D80-150A
3356931 EAMM-A-D100-100A-S1	1593628 EAMF-A-77A-100A	1485674 EAMC-56-58-19-24	1593914 EAMK-A-D100-77A/B	3356966 EADS-F-D100-100A
2946765 EAMM-A-D100-120G-S1	2449380 EAMF-A-77B-120G-S1	3187895 EAMC-67-62-24-25	1593914 EAMK-A-D100-77A/B	8022148 EADS-F-D100-120G
8157276 EAMM-A-D100-150A-S1	–	1451407 EAMC-67-62-24-24	8159895 EAMK-A-D100-150A	8162068 EADS-F-D100-150A

Datasheet

Dimensions (sample illustration)

Download CAD data → www.festo.com

EGC-TB...

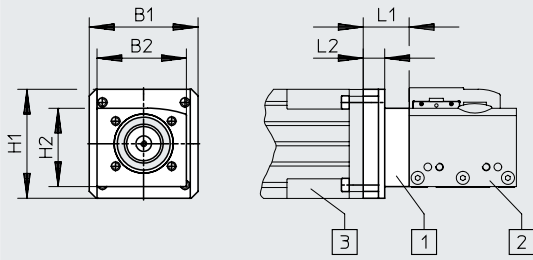

Main illustration:

- [1] Axial kit
- [2] Toothed belt axis
- [3] Motor

ELGA...-TB

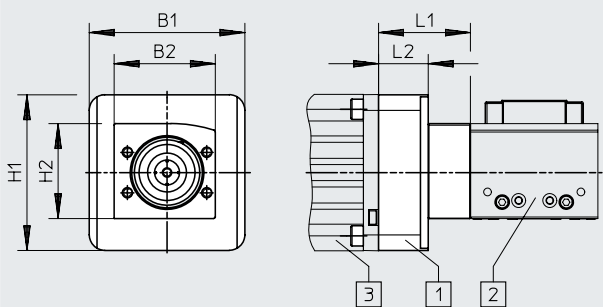

Main illustration:

- [1] Axial kit
- [2] Toothed belt axis
- [3] Motor

ELCC-TB...

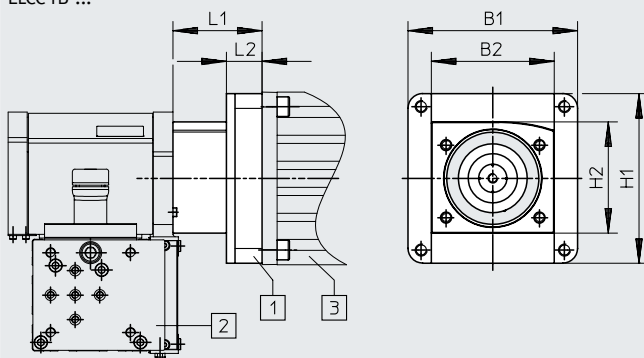

Main illustration:

- [1] Axial kit
- [2] Cantilever axis
- [3] Motor

Datasheet

Type	B1	B2	H1	H2	L1	L2
EAMM-A-L27-40A	40	–	40	–	18.1	–
EAMM-A-L27-40G	50	40	50	50	28.7	–
EAMM-A-L27-40R	40	–	40	–	27.1	–
EAMM-A-L27-40RA	40	–	40	–	20.1	–
EAMM-A-L27-42A	42.5	38	58	38	26.1	22.1
EAMM-A-L27-50GA	55	55	55	39.5	26.6	21.6
EAMM-A-L27-55A	55	40	55	55	23.1	–
EAMM-A-L27-57A	56	39.5	56	56	23.1	–
EAMM-A-L27-57AA	56	56	56	39.5	23.1	18.1
EAMM-A-L27-57AB	56	56	56	39.5	23.1	18.1
EAMM-A-L27-57AC	56	56	56	39.5	23.1	18.1
EAMM-A-L27-58AA	55	55	55	39.5	22.1	17.1
EAMM-A-L27-60G	60	60	60	39.5	37.1	32.1
EAMM-A-L27-60RA	60	60	60	39.5	32.1	27.1
EAMM-A-L27-60RB	60	60	60	39.5	25.1	20.1
EAMM-A-L38-40G	54	48	54	42	33	25
EAMM-A-L38-50GA	55	57.5	55	50.3	30.4	14.7
EAMM-A-L38-55A	55	57.5	55	50.3	26.7	11
EAMM-A-L38-56GA	56	57.5	56	50.3	44.9	29.2
EAMM-A-L38-57A	56	57.5	56	50.3	26.7	11
EAMM-A-L38-57AA	56	57.5	56	50.3	26.9	11.2
EAMM-A-L38-58AA	55	57.5	55	50.3	25.9	10.2
EAMM-A-L38-60AA	60	57.5	60	50.3	27.2	11.5
EAMM-A-L38-60G	60	57.5	60	50.3	41.7	26
EAMM-A-L38-60H	60	57.5	60	50.3	41.7	24.5
EAMM-A-L38-60P	61.4	57.5	61.4	50.3	36.7	21
EAMM-A-L38-60PA	61.4	57.5	61.4	50.3	35.9	20.2
EAMM-A-L38-60R	61.4	57.5	61.4	50.3	36.7	21
EAMM-A-L38-60RB	61.4	57.5	61.4	50.3	28.9	13.2
EAMM-A-L38-68GA	64	57.5	64	50.3	54.9	39.2
EAMM-A-L38-70A	70	57.5	70	50.3	29.5	13.8
EAMM-A-L38-70AA	70	57.5	70	50.3	35.9	20.2
EAMM-A-L38-70GA	73	57.5	73	50.3	41.9	26.2
EAMM-A-L38-72GA	72	57.5	72	50.3	54.9	24
EAMM-A-L38-84AA	96	57.5	96	50.3	45.9	30.2
EAMM-A-L38-87A	85.8	57.5	85.8	50.3	33.7	18
EAMM-A-L38-88A	88	57.5	88	50.3	35.9	20.2
EAMM-A-L48-40G	55	60	55	54	50.3	26.3
EAMM-A-L48-50GA	60	65	60	52	41.8	17.8
EAMM-A-L48-55A	55	60	55	54	37.3	13.3
EAMM-A-L48-56GA	56	65	56	52	56.3	32.3
EAMM-A-L48-60G	60	65	60	61	52.5	24.5
EAMM-A-L48-60H	60	65	60	61	52.5	24.5
EAMM-A-L48-60PA	61.4	65	61.4	61	47.3	19.3
EAMM-A-L48-68GA	64	65	64	61	65.3	37.3
EAMM-A-L48-70A	70	65	70	61	40.2	12.2
EAMM-A-L48-70AA	70	65	70	61	47.3	19.3
EAMM-A-L48-70GA	74	65	74	61	53.3	25.3
EAMM-A-L48-72GA	72	65	72	61	65.3	37.3
EAMM-A-L48-75GA	75	60	75	54	74.4	50.4

Datasheet

Dimensions (sample illustration)

Download CAD data → www.festo.com

EGC-TB...

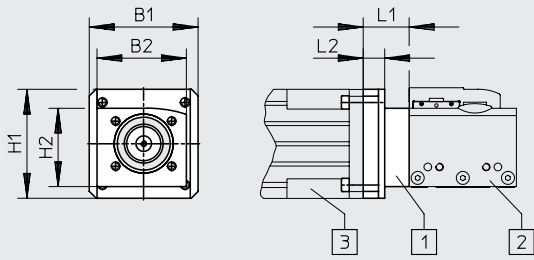

Main illustration:

- [1] Axial kit
- [2] Toothed belt axis
- [3] Motor

ELGA...-TB

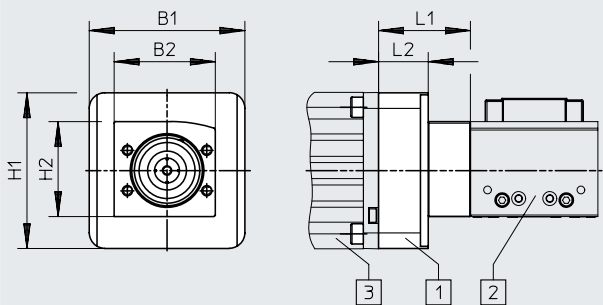

Main illustration:

- [1] Axial kit
- [2] Toothed belt axis
- [3] Motor

ELCC-TB...

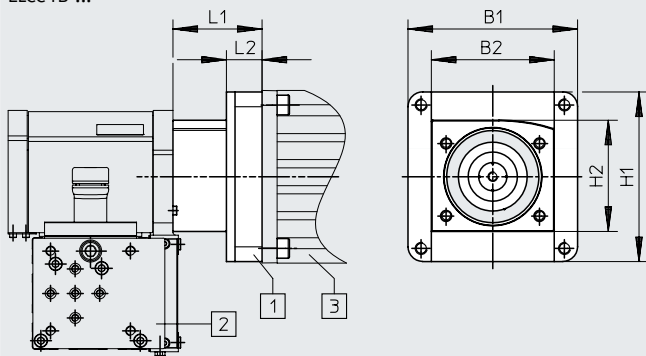

Main illustration:

- [1] Axial kit
- [2] Cantilever axis
- [3] Motor

Datasheet

Type	B1	B2	H1	H2	L1	L2
EAMM-A-L48-80G	80	65	80	61	58	30.4
EAMM-A-L48-80P-G2	82	65	82	54	54	21
EAMM-A-L48-80PB	82	60	82	54	54	21
EAMM-A-L48-82AA	82	65	82	61	47.3	19.3
EAMM-A-L48-84AA	96	65	96	61	58.4	30.4
EAMM-A-L48-87A	85.8	65	85.8	61	44	16
EAMM-A-L48-88A	88	65	88	61	47.3	19.3
EAMM-A-L48-90GA	92	65	92	61	64.4	36.4
EAMM-A-L48-90R	90	65	90	61	52.3	24.3
EAMM-A-L48-92RA	90	65	90	61	57.3	29.3
EAMM-A-L48-100A-G2	104	60	104	54	59	24
EAMM-A-L48-120GA	90	65	90	61	58.4	30.4
EAMM-A-L62-56GA	80	80	68	68	60.9	–
EAMM-A-L62-60H	68	68	68	68	56.9	–
EAMM-A-L62-68GA	92	92	66	75	69.9	37.9
EAMM-A-L62-72GA	92	92	72	75	69.9	37.9
EAMM-A-L62-70GA	76	76	72	72	56.4	–
EAMM-A-L62-75GA	92	92	75	75	77.9	–
EAMM-A-L62-80G	100	100	100	90.5	62.5	14.5
EAMM-A-L62-84AA	96	80	96	70	61.9	25.9
EAMM-A-L62-88A	88	80	88	70	51.9	19.9
EAMM-A-L62-90GA	92	92	92	75	67.9	35.9
EAMM-A-L62-100A-G2	104	92	104	79	62.5	24
EAMM-A-L62-108AA	114	100	114	90.5	75.5	27.5
EAMM-A-L62-115GA	138	92	102	75	109.9	62.9
EAMM-A-L62-120G	120	92	120	75	76.9	54.9
EAMM-A-L62-120GA	92	92	92	75	61.9	29.9
EAMM-A-L62-120GB	120	92	120	75	71.9	15.9
EAMM-A-L62-120GC	132	92	132	75	91.9	22.9
EAMM-A-L62-150A	151	100	151	79	72.5	30
EAMM-A-L95-75GA	138	140	102	120	81.4	32.4
EAMM-A-L95-68GA	138	140	102	120	73.4	24.4
EAMM-A-L95-72GA	138	140	102	120	73.4	24.4
EAMM-A-L95-80G-G2	140	140	106.4	120	66	17
EAMM-A-L95-90GA	138	140	102	120	71.4	22.4
EAMM-A-L95-115GA	138	138	102	102	113.4	–
EAMM-A-L95-120G-G2	114	140	114	120	81	32
EAMM-A-L95-120GA	138	140	102	120	65.4	16.4
EAMM-A-L95-120GB	138	140	122	120	75.4	26.4
EAMM-A-L95-120GC	138	138	124	102	95.4	21.4
EAMM-A-L95-150A-G2	151	140	151	120	76	27
EAMM-A-L95-160G	164	140	164	120	112	63
EAMM-A-L95-190A-G2	190	140	190	120	86	37
EAMM-A-L95-190B-G2	190	140	190	120	85	36

Datasheet

Dimensions (sample illustration)

Download CAD data → www.festo.com

EGC-TB...

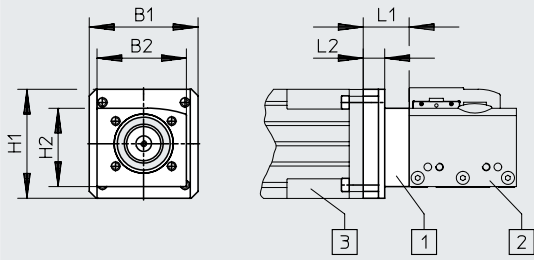

Main illustration:

- [1] Axial kit
- [2] Toothed belt axis
- [3] Motor

ELGA...-TB

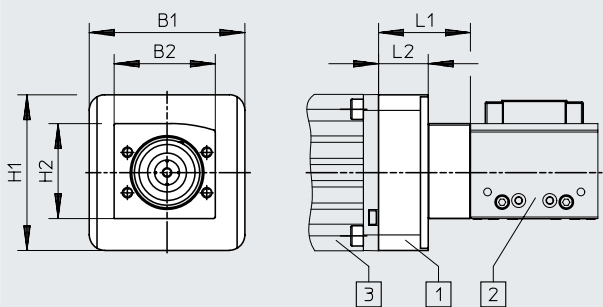

Main illustration:

- [1] Axial kit
- [2] Toothed belt axis
- [3] Motor

ELCC-TB...

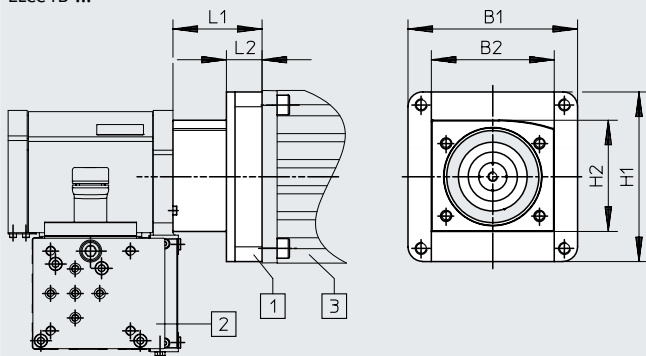



Main illustration:

- [1] Axial kit
- [2] Cantilever axis
- [3] Motor

Datasheet

Type	B1	B2	H1	H2	L1	L2
EAMM-A-N38-40G	58	56	55	50	40.3	38.3
EAMM-A-N38-50GA	58	56	55	50	38.8	36.8
EAMM-A-N38-56GA	60	56	56	50	53.4	51.4
EAMM-A-N38-60G	60	57.5	60	50.3	49.5	33
EAMM-A-N38-60H	60	57.5	60	50.3	49.5	33
EAMM-A-N38-60PA	61.4	56	61.4	50	44.4	32.4
EAMM-A-N38-60RA	61.4	56	61.4	50	44.4	32.4
EAMM-A-N38-90R	90	56	90	50	49.4	37.4
EAMM-A-N38-92RA	90	56	90	50	54.4	42.4
EAMM-A-N38-70GA	74	55	74	48.6	50.4	48.4
EAMM-A-N38-68GA	64	56	64	50	62.4	50.4
EAMM-A-N38-70A	70	57.5	70	50.3	37.5	21
EAMM-A-N38-70AA	70	56	70	50	44.4	32.4
EAMM-A-N38-72GA	72	56	72	50	62.4	50.4
EAMM-A-N38-87A	85.5	57.5	85.5	50.3	42	25.5
EAMM-A-N38-88A	88	56	88	50	44.4	32.4
EAMM-A-N48-50GA	68	65	58	56	43	29
EAMM-A-N48-56GA	68	65	58	56	57.5	53.5
EAMM-A-N48-60G	66	65	60	61	53.1	26
EAMM-A-N48-60H	66	65	60	61	53.1	26
EAMM-A-N48-60PA	66	65	66	56	48.5	34.5
EAMM-A-N48-68GA	68	65	68	56	66.5	35.5
EAMM-A-N48-70AA	70	65	70	56	48.5	34.5
EAMM-A-N48-70GA	74	62	74	59	54.5	50.5
EAMM-A-N48-72GA	72	65	72	56	66.5	35.5
EAMM-A-N48-75GA	75	65	75	56	74.5	43.5
EAMM-A-N48-80P	82	64	82	52	58	21
EAMM-A-N48-80PB	82	64	82	52	58	20
EAMM-A-N48-84AA	96	65	96	56	58.5	44.5
EAMM-A-N48-88A	88	65	88	56	48.5	34.5
EAMM-A-N48-90GA	93	62	93	59	64.5	60.5
EAMM-A-N48-90GB	132	65	92	75	54.5	34
EAMM-A-N48-100A	100	65	100	61	59	31.9
EAMM-A-N48-120GA	90	65	90	56	58.5	44.5
EAMM-A-N80-68GA	96	92	96	82	70	24.5
EAMM-A-N80-72GA	96	92	96	82	70	26.5
EAMM-A-N80-70GA	96	92	96	82	58	44
EAMM-A-N80-75GA	96	92	96	82	78.5	64.5
EAMM-A-N80-80G	100	100	100	90.5	62.5	19
EAMM-A-N80-84AA	96	92	96	82	62.5	48.5
EAMM-A-N80-90GA	116	92	96	82	68.5	54.5
EAMM-A-N80-90GB	124	92	96	82	60.5	52.5
EAMM-A-N80-100A	100	92	100	82	62.5	48.5
EAMM-A-N80-115GA	116	92	102	82	110.5	65
EAMM-A-N80-120G	124	100	124	90.5	77.5	34
EAMM-A-N80-120GA	140	92	102	82	62.5	60.5
EAMM-A-N80-120GB	140	92	122	82	82.5	37
EAMM-A-N80-120GC	140	92	124	82	92.5	47
EAMM-A-N80-150A	151	100	151	90	72.5	30

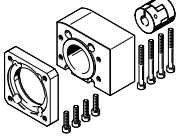
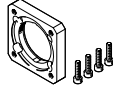
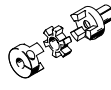
Datasheet



Ordering data – Individual components				
Axial kit	Consisting of:			
	Motor flange	Coupling	Coupling housing	Screw kit
				
Part no. Type	Part no. Type	Part no. Type	Part no. Type	Part no. Type
★ 557974 EAMM-A-L27-40G	558015 EAMF-A-L27-40G	557998 EAMD-19-15-10-8X10	–	–
557975 EAMM-A-L27-55A	558016 EAMF-A-L27-55A	557999 EAMD-19-15-9-8X10	–	–
★ 560678 EAMM-A-L27-57A	560690 EAMF-A-L27-57A	561292 EAMD-16-15-6.35-8X10	–	–
3683331 EAMM-A-L38-55A	558176 EAMF-A-38A-55A	3717923 EAMD-25-22-9-10X12	558011 EAMK-A-L38-38A	567484 EAHM-L2-M5-30
★ 560679 EAMM-A-L38-57A	560692 EAMF-A-38A-57A	561293 EAMD-25-22-6.35-10X12	558011 EAMK-A-L38-38A	567484 EAHM-L2-M5-30
★ 557978 EAMM-A-L38-60G	558017 EAMF-A-38A-60G/H	558000 EAMD-25-22-11-10X12	558011 EAMK-A-L38-38A	567485 EAHM-L2-M5-35
1456610 EAMM-A-L38-60H	558017 EAMF-A-38A-60G/H	1453861 EAMD-28-22-14-10X12	558011 EAMK-A-L38-38A	567485 EAHM-L2-M5-35
★ 2037246 EAMM-A-L38-60P	1987412 EAMF-A-38A-60P	1453861 EAMD-28-22-14-10X12	558011 EAMK-A-L38-38A	567485 EAHM-L2-M5-35
557979 EAMM-A-L38-70A	558018 EAMF-A-38A-70A	558000 EAMD-25-22-11-10X12	558011 EAMK-A-L38-38A	567484 EAHM-L2-M5-30
★ 560680 EAMM-A-L38-87A	560693 EAMF-A-38A-87A	558000 EAMD-25-22-11-10X12	558011 EAMK-A-L38-38A	567485 EAHM-L2-M5-35
★ 557983 EAMM-A-L48-60G	558019 EAMF-A-48A-60G/H	558001 EAMD-32-32-11-16X20	558012 EAMK-A-L48-48A	567487 EAHM-L2-M5-45
1456611 EAMM-A-L48-60H	558019 EAMF-A-48A-60G/H	1377840 EAMD-32-32-14-16X20	558012 EAMK-A-L48-48A	567487 EAHM-L2-M5-45
557982 EAMM-A-L48-70A	558025 EAMF-A-48A-70A	558001 EAMD-32-32-11-16X20	558012 EAMK-A-L48-48A	567486 EAHM-L2-M5-40
★ 560683 EAMM-A-L48-87A	560695 EAMF-A-48A-87A	558001 EAMD-32-32-11-16X20	558012 EAMK-A-L48-48A	567487 EAHM-L2-M5-45
★ 557989 EAMM-A-L62-80G	558021 EAMF-A-62A-80G	558004 EAMD-56-46-20-23X27	558013 EAMK-A-L62-62A	567492 EAHM-L2-M6-65-L
8157270 EAMM-A-L62-150A	–	558005 EAMD-56-46-24-23X27	8159893 EAMK-A-L62-150A	–
3660191 EAMM-A-L95-80G-G2	3305700 EAMF-A-95B-80G	3717812 EAMD-67-51-20-32X32-U	3712650 EAMK-A-L95-95A/B-G2	–
★ 3659941 EAMM-A-L95-120G-G2	3659724 EAMF-A-95A-120G-G2	558006 EAMD-67-51-25-32X32-U	3712650 EAMK-A-L95-95A/B-G2	567496 EAHM-L2-M8-70
8157280 EAMM-A-L95-150A-G2	8157268 EAMF-A-95A-150A	558008 EAMD-67-51-24-32X32-U	3712650 EAMK-A-L95-95A/B-G2	1201751 EAHM-L5-M8-75
3659562 EAMM-A-L95-190A-G2	1378473 EAMF-A-95A-190A	1379269 EAMD-67-51-32-32X32-U	3712650 EAMK-A-L95-95A/B-G2	567497 EAHM-L2-M8-80
8157282 EAMM-A-L95-190B-G2	8157269 EAMF-A-95A-190B	8196716 EAMD-67-65-32-32X32-U	3712650 EAMK-A-L95-95A/B-G2	567497 EAHM-L2-M8-80

Festo Core Range

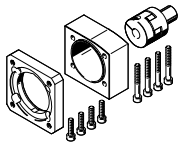
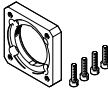
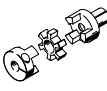
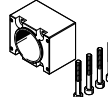

Generally ready for shipping ex works in 24 hours
 Generally ready for shipping ex works in 5 days

Datasheet

Ordering data – Individual components				
Axial kit	Consisting of:			
	Motor flange	Coupling	Coupling housing	Screw kit
				
Part no. Type	Part no. Type	Part no. Type	Part no. Type	Part no. Type
★ 1202253 EAMM-A-N38-60G	1190015 EAMF-A-38D-60G/H	558001 EAMD-32-32-11-16X20	1345947 EAMK-A-N38-38D	1202262 EAHM-L5-M6-40
1456616 EAMM-A-N38-60H	1190015 EAMF-A-38D-60G/H	1377840 EAMD-32-32-14-16X20	1345947 EAMK-A-N38-38D	1202262 EAHM-L5-M6-40
1202331 EAMM-A-N38-70A	1202337 EAMF-A-38D-70A	558001 EAMD-32-32-11-16X20	1345947 EAMK-A-N38-38D	1202288 EAHM-L5-M6-35
★ 3324111 EAMM-A-N38-87A	3319868 EAMF-A-38D-87A	558001 EAMD-32-32-11-16X20	1345947 EAMK-A-N38-38D	1202288 EAHM-L5-M6-35
★ 1972527 EAMM-A-N48-60G	1460111 EAMF-A-48C-60G/H	558001 EAMD-32-32-11-16X20	1345949 EAMK-A-N48-48C	4984529 EAHM-L5-M6-45
1456618 EAMM-A-N48-60H	1460111 EAMF-A-48C-60G/H	1377840 EAMD-32-32-14-16X20	1345949 EAMK-A-N48-48C	4984529 EAHM-L5-M6-45
★ 1258793 EAMM-A-N48-80G	1190375 EAMF-A-48C-80G	1781043 EAMD-42-40-20-16X25-U	1345949 EAMK-A-N48-48C	1201874 EAHM-L5-M6-50
8063592 EAMM-A-N48-80P	–	558002 EAMD-42-40-19-16X25	5204317 EAMK-A-N48-80P	–
1201894 EAMM-A-N48-100A	1201924 EAMF-A-48C-100A	558002 EAMD-42-40-19-16X25	1345949 EAMK-A-N48-48C	1201874 EAHM-L5-M6-50
★ 2372096 EAMM-A-N80-80G	2372201 EAMF-A-80A-80G	558004 EAMD-56-46-20-23X27	1345953 EAMK-A-N80-80A	1201712 EAHM-L5-M8-60
★ 1201695 EAMM-A-N80-120G	1190702 EAMF-A-80A-120G	1188801 EAMD-56-46-25-23X27	1345953 EAMK-A-N80-80A	1201712 EAHM-L5-M8-60
8157277 EAMM-A-N80-150A	–	558005 EAMD-56-46-24-23X27	8159896 EAMK-A-N80-150A	–

Festo Core Range



Generally ready for shipping ex works in 24 hours

Generally ready for shipping ex works in 5 days

Datasheet

Dimensions (sample illustration)

Download CAD data → www.festo.com

EGC-BS-...

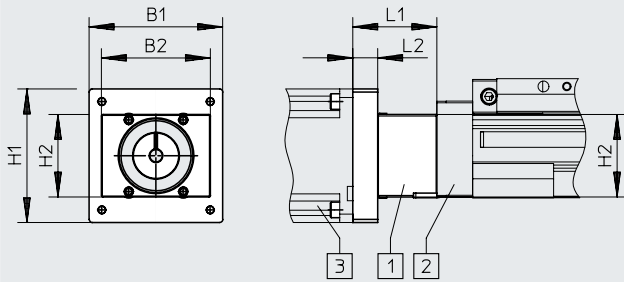

Main illustration:

- [1] Axial kit
- [2] Ball screw (spindle) axis
- [3] Motor

ELGA-BS-...-

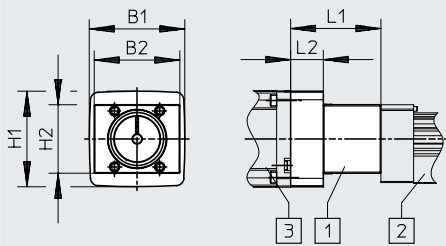

Main illustration:

- [1] Axial kit
- [2] Ball screw (spindle) axis
- [3] Motor

EGC-HD-BS-...

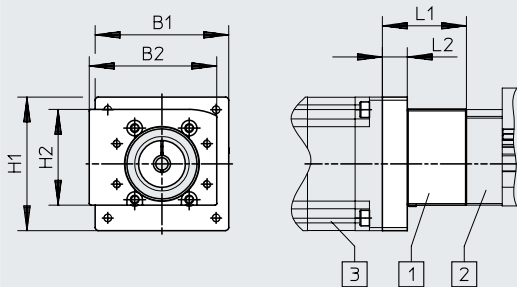



Main illustration:

- [1] Axial kit
- [2] Ball screw (spindle) axis
- [3] Motor

Datasheet

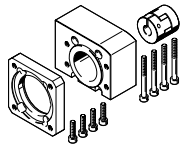
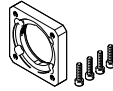
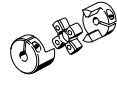
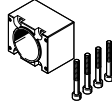

Type	B1	B2	H1	H2	L1	L2
EAMM-A-S38-40A-G2	58	55	44	44	44	7
EAMM-A-S38-40G-G2	60	55	60	44	54	17
EAMM-A-S38-40P-G2	58	55	44	44	44.7	10.7
EAMM-A-S38-42A-G2	58	55	44	44	52	15
EAMM-A-S38-50GA	62	55	62	44	60.3	23.3
EAMM-A-S38-55A-G2	55	55	55	44	48	11
EAMM-A-S38-57A-G2	56	55	56	44	48	11
EAMM-A-S38-58AA	58	55	58	44	47.6	10.6
EAMM-A-S38-60AA	60	55	60	44	48.5	11.5
EAMM-A-S38-60R	62	55	62	44	48.8	11.8
EAMM-A-S38-60RA	62	55	62	44	48.8	11.8
EAMM-A-S38-60P-G2	61.4	55	61.4	44	58	21
EAMM-A-S48-40G-G2	70	70	54	53	55	–
EAMM-A-S48-50GA	70	70	54	53	52	14
EAMM-A-S48-55A-G2	70	70	55	53	47.2	9.2
EAMM-A-S48-57A-G2	70	70	55	53	47.2	9.2
EAMM-A-S48-58AA	70	70	58	53	47.2	9.2
EAMM-A-S48-60AA	60	70	60	53	48.5	10.5
EAMM-A-S48-60G-G2	60	70	60	53	62.5	24.5
EAMM-A-S48-60H-G2	60	70	60	53	62.5	24.5
EAMM-A-S48-60P-G2	61.4	70	61.4	53	57.2	19.2
EAMM-A-S48-60RA	62	70	62	53	57.2	19.2
EAMM-A-S48-70A-G2	70	70	70	53	50.2	12.2
EAMM-A-S48-70AA	70	70	70	53	57.3	19.3
EAMM-A-S48-87A-G2	85.8	70	85.8	53	54	16
EAMM-A-S62-60G-G2	80	80	80	70	84.5	18
EAMM-A-S62-60H-G2	80	80	80	70	84.5	18
EAMM-A-S62-70A-G2	82	80	70	70	78.5	12
EAMM-A-S62-70GA	82	80	82	70	79.5	13
EAMM-A-S62-80G-G2	100	80	100	70	81	14.5
EAMM-A-S62-80P-G2	82	80	82	70	77	10.5
EAMM-A-S62-80PB	82	80	82	70	77	10.5
EAMM-A-S62-82AA	82	80	82	70	79	12.5
EAMM-A-S62-84AA	84	80	84	70	81	14.5
EAMM-A-S62-87A-G2	85.8	80	85.8	70	81.5	15
EAMM-A-S62-100A-G2	100.5	80	100.5	70	81	14.5
EAMM-A-S62-150A-G2	151	80	151	70	91	24.5
EAMM-A-S95-84AA	140	140	110	110	85.5	17
EAMM-A-S95-90GA	140	140	110	110	94	21.9
EAMM-A-S95-100A-G2	140	140	100	110	85.5	17
EAMM-A-S95-150A-G2	151	140	151	110	95.5	30

Datasheet

Ordering data – Individual components				
Axial kit	Consisting of:			
	Motor flange	Coupling	Coupling housing	Screw kit
				
Part no. Type	Part no. Type	Part no. Type	Part no. Type	Part no. Type
3637971 EAMM-A-S38-40A-G2	558175 EAMF-A-38B-40A	558312 EAMC-30-32-6-6	3637942 EAMK-A-S38-38A/B-G2	–
1456647 EAMM-A-S38-40G-G2	1460097 EAMF-A-38A-40G	562681 EAMC-30-32-6-10	3637942 EAMK-A-S38-38A/B-G2	567488 EAHM-L2-M5-50
★ 3637972 EAMM-A-S38-40P-G2	2219077 EAMF-A-38B-40P	533708 EAMC-30-32-6-8	3637942 EAMK-A-S38-38A/B-G2	–
★ 3637965 EAMM-A-S38-42A-G2	560691 EAMF-A-38B-42A	561333 EAMC-30-32-5-6	3637942 EAMK-A-S38-38A/B-G2	–
3637967 EAMM-A-S38-55A-G2	558176 EAMF-A-38A-55A	551003 EAMC-30-32-6-9	3637942 EAMK-A-S38-38A/B-G2	567488 EAHM-L2-M5-50
★ 3637956 EAMM-A-S38-57A-G2	560692 EAMF-A-38A-57A	551002 EAMC-30-32-6-6.35	3637942 EAMK-A-S38-38A/B-G2	567488 EAHM-L2-M5-50
★ 3637958 EAMM-A-S38-60P-G2	1987412 EAMF-A-38A-60P	1233256 EAMC-30-32-6-14	3637942 EAMK-A-S38-38A/B-G2	567489 EAHM-L2-M5-55
1456650 EAMM-A-S48-40G-G2	4067069 EAMF-A-48B-40G	558029 EAMC-30-32-8-10	3637941 EAMK-A-S48-48A/B-G2	–
3637961 EAMM-A-S48-55A-G2	558177 EAMF-A-48B-55A	543423 EAMC-30-32-8-9	3637941 EAMK-A-S48-48A/B-G2	–
★ 3637963 EAMM-A-S48-57A-G2	560694 EAMF-A-48B-57A	543421 EAMC-30-32-6.35-8	3637941 EAMK-A-S48-48A/B-G2	–
2256701 EAMM-A-S48-60G-G2	558019 EAMF-A-48A-60G/H	551004 EAMC-30-32-8-11	3637941 EAMK-A-S48-48A/B-G2	567489 EAHM-L2-M5-55
1456652 EAMM-A-S48-60H-G2	558019 EAMF-A-48A-60G/H	562682 EAMC-30-32-8-14	3637941 EAMK-A-S48-48A/B-G2	567489 EAHM-L2-M5-55
★ 3637964 EAMM-A-S48-60P-G2	2220620 EAMF-A-48A-60P	562682 EAMC-30-32-8-14	3637941 EAMK-A-S48-48A/B-G2	567489 EAHM-L2-M5-55

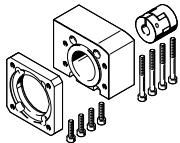
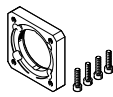
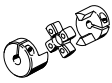
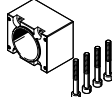

Datasheet

Ordering data – Individual components				
Axial kit	Consisting of:			
	Motor flange	Coupling	Coupling housing	Screw kit
				
Part no. Type	Part no. Type	Part no. Type	Part no. Type	Part no. Type
3637957 EAMM-A-S48-70A-G2	558025 EAMF-A-48A-70A	551004 EAMC-30-32-8-11	3637941 EAMK-A-S48-48A/B-G2	567488 EAHM-L2-M5-50
★ 3637962 EAMM-A-S48-87A-G2	560695 EAMF-A-48A-87A	551004 EAMC-30-32-8-11	3637941 EAMK-A-S48-48A/B-G2	567489 EAHM-L2-M5-55
2297649 EAMM-A-S62-60G-G2	1460112 EAMF-A-62A-60G/H	525864 EAMC-40-66-11-12	3637940 EAMK-A-S62-62A/B-G2	567495 EAHM-L2-M6-90
1456654 EAMM-A-S62-60H-G2	1460112 EAMF-A-62A-60G/H	1452803 EAMC-40-66-12-14	3637940 EAMK-A-S62-62A/B-G2	567495 EAHM-L2-M6-90
3637959 EAMM-A-S62-70A-G2	558179 EAMF-A-62B-70A	558313 EAMC-42-66-11-12	3637940 EAMK-A-S62-62A/B-G2	–
1972530 EAMM-A-S62-80G-G2	2116672 EAMF-A-62B-80G	2138701 EAMC-42-50-12-20	3637940 EAMK-A-S62-62A/B-G2	–
★ 3637970 EAMM-A-S62-80P-G2	2222624 EAMF-A-62B-80P	551005 EAMC-42-50-12-19	3637940 EAMK-A-S62-62A/B-G2	–
★ 3637966 EAMM-A-S62-87A-G2	560696 EAMF-A-62B-87A	558313 EAMC-42-66-11-12	3637940 EAMK-A-S62-62A/B-G2	–
★ 3637960 EAMM-A-S62-100A-G2	558026 EAMF-A-62A-100A	551005 EAMC-42-50-12-19	3637940 EAMK-A-S62-62A/B-G2	567494 EAHM-L2-M6-80
8157272 EAMM-A-S62-150A-G2	8156626 EAMF-A-62A-150A	558314 EAMC-42-50-12-24	3637940 EAMK-A-S62-62A/B-G2	567495 EAHM-L2-M6-90
3637955 EAMM-A-S95-100A-G2	558182 EAMF-A-95B-100A	558315 EAMC-56-58-19-25	3637939 EAMK-A-S95-95A/B-G2	–
8157279 EAMM-A-S95-150A-G2	–	558316 EAMC-56-58-24-25	8160697 EAMK-A-S95-150A	–

Festo Core Range



Generally ready for shipping ex works in 24 hours

Generally ready for shipping ex works in 5 days

Datasheet

Dimensions (sample illustration)

Download CAD data → www.festo.com

EGC-HD-TB...

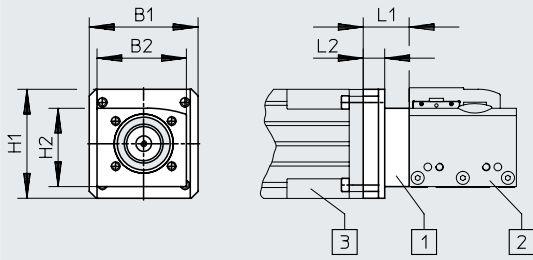

Main illustration:

- [1] Axial kit
- [2] Toothed belt axis
- [3] Motor

Type	B1	B2	H1	H2	L1	L2
EAMM-A-M43-40G	58	56	55	50	23.8	21.8
EAMM-A-M43-50GA	58	56	55	50	22.3	20.3
EAMM-A-M43-55A	58	56	55	50	17.8	15.8
EAMM-A-M43-56GA	60	56	56	50	36.9	34.9
EAMM-A-M43-60G	60	–	60	–	33	–
EAMM-A-M43-60H	60	–	60	–	33	–
EAMM-A-M43-68GA	64	55	64	49.4	45.9	33.9
EAMM-A-M43-70GA	74	55	74	49.4	33.9	31.9
EAMM-A-M43-72GA	72	56	72	50	45.9	33.9
EAMM-A-M43-70A	70	56	70	50	20.9	18.9
EAMM-A-M43-70AA	70	56	70	50	27.9	15.9
EAMM-A-M43-90R	90	56	90	50	32.9	20.9
EAMM-A-M43-92RA	90	56	90	50	37.9	25.9
EAMM-A-M48-40G	68	–	60	–	17.5	–
EAMM-A-M48-50GA	68	–	58	–	16	–
EAMM-A-M48-56GA	68	65	58	56	30.5	26.5
EAMM-A-M48-60H	66	–	60	–	26	–
EAMM-A-M48-60G	65	65	60	56	26.5	22.5
EAMM-A-M48-68GA	68	65	68	56	39.5	35.5
EAMM-A-M48-70GA	74	65	74	54	27.5	23.5
EAMM-A-M48-72GA	72	65	72	56	39.5	35.5
EAMM-A-M48-75GA	75	65	75	56	47.5	43.5
EAMM-A-M48-88A	88	65	88	56	21.5	17.5
EAMM-A-M48-84AA	96	65	96	56	31.5	27.5
EAMM-A-M48-80G	100	–	100	–	32	–
EAMM-A-M48-90GA	93	65	93	56	37.5	33.5
EAMM-A-M48-90GB	132	64	94	52	31.5	31
EAMM-A-M48-120GA	90	65	90	56	31.5	27.5

Datasheet

Dimensions (sample illustration)

Download CAD data → www.festo.com

EGC-HD-TB-...

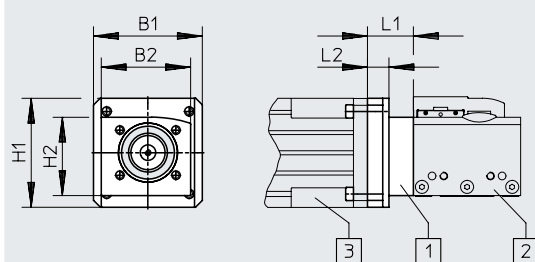

Main illustration:

- [1] Axial kit
- [2] Toothed belt axis
- [3] Motor

Type	B1	B2	H1	H2	L1	L2
EAMM-A-M80-68GA	96	92	96	82	26.5	24.5
EAMM-A-M80-75GA	96	92	96	82	35	33
EAMM-A-M80-84AA	96	92	96	82	27	25
EAMM-A-M80-80G	96	92	96	82	19	15
EAMM-A-M80-90GA	116	92	96	82	33	31
EAMM-A-M80-115GA	116	92	102	82	67	65
EAMM-A-M80-120G	124	–	124	–	34	–
EAMM-A-M80-120GA	140	92	102	82	35	33
EAMM-A-M80-120GB	140	92	122	82	39	37
EAMM-A-M80-120GC	140	92	124	82	49	47

Ordering data – Individual components

Axial kit	Consisting of:		
	Motor flange	Coupling	Centring ring
Part no. Type	Part no. Type	Part no. Type	Part no. Type
1190076 EAMM-A-M43-60G	1597579 EAMF-A-43D-60G/H	558001 EAMD-32-32-11-16X20	575962 EAML-43-4-43
1456612 EAMM-A-M43-60H	1597579 EAMF-A-43D-60G/H	1377840 EAMD-32-32-14-16X20	575962 EAML-43-4-43
1456614 EAMM-A-M48-60H	1460111 EAMF-A-48C-60G/H	3420022 EAMD-42-40-14-16X25-U	558031 EAML-48-4-48
1190421 EAMM-A-M48-80G	1190375 EAMF-A-48C-80G	1781043 EAMD-42-40-20-16X25-U	558031 EAML-48-4-48
1190774 EAMM-A-M80-120G	1190702 EAMF-A-80A-120G	1781045 EAMD-56-46-25-23X27-U	1209006 EAML-80-6-80

Datasheet

Dimensions (sample illustration)

Download CAD data → www.festo.com

ELGC-TB-...

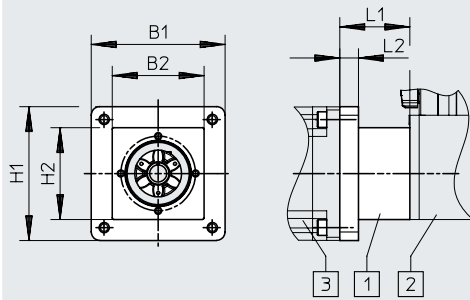

Main illustration:

- [1] Axial kit
- [2] Toothed belt axis
- [3] Motor

ELGC-BS-...

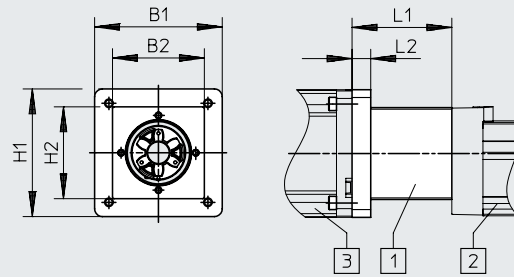

Main illustration:

- [1] Axial kit
- [2] Ball screw (spindle) axis
- [3] Motor

EGSC-BS-...

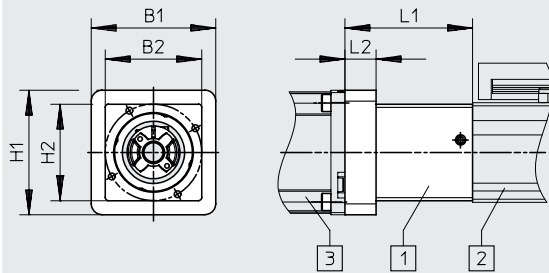

Main illustration:

- [1] Axial kit
- [2] Mini slide
- [3] Motor

EPCC

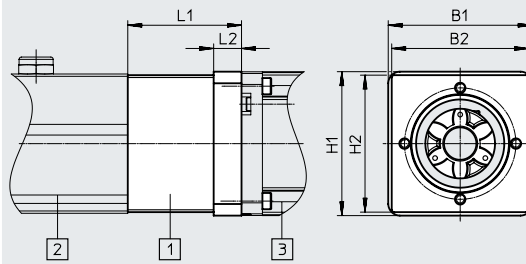

Main illustration:

- [1] Axial kit
- [2] Electric cylinder
- [3] Motor

ELGT-BS-...

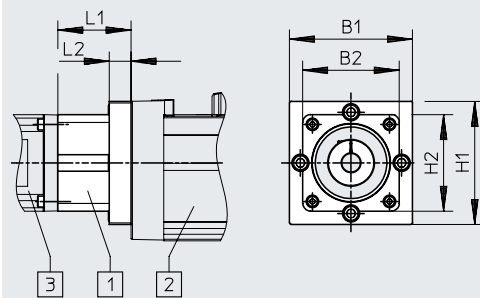

Main illustration:

- [1] Axial kit
- [2] Ball screw (spindle) axis
- [3] Motor

Datasheet

Dimensions and ordering data						
Type	B1	B2	H1	H2	L1 ±0.1	L2
EAMM-A-V20-28A	28	24.5	28	24.5	36.4	4
EAMM-A-V20-28AA	28	24.5	28	24.5	31.4	5.5
EAMM-A-V25-35A	35.2	31	35.2	31	40	7
EAMM-A-V25-38AA	38	31	38	31	46	12
EAMM-A-V25-40P	40	31	40	31	41	10
EAMM-A-V25-40R	40	31	40	31	46	14
EAMM-A-V25-40RA	40	31	40	31	39	14
EAMM-A-V25-42A	42	31	42	31	40	6
EAMM-A-V25-42AB	42	31	42	31	36	6
EAMM-A-V32-38AA	38	44	38	44	46	35
EAMM-A-V32-40P	40	44	40	44	41	30
EAMM-A-V32-40R	40	44	40	44	46	35
EAMM-A-V32-40RA	40	44	40	44	39	28
EAMM-A-V32-42A	42	44	42	44	40	32
EAMM-A-V32-42AB	42	44	42	44	36	28
EAMM-A-V32-57A	56.4	44	56.4	44	41.5	11
EAMM-A-V32-58AA	58	44	58	44	41	17
EAMM-A-V32-60AA	60	44	60	44	42	17
EAMM-A-V32-60P	62	44	62	44	55.1	11
EAMM-A-V32-60PA	62	44	62	44	55	17
EAMM-A-V32-60RA	62	44	62	44	55	17
EAMM-A-T42-55A	59	59	59	59	43	–
EAMM-A-T42-57A	59	59	59	59	43	–
EAMM-A-T42-58AA	59	59	59	59	43	–
EAMM-A-T42-60AA	59	59	59	59	43	–
EAMM-A-T42-60AB	59	59	59	59	43	–
EAMM-A-T42-60P	62	59	62	59	49	12
EAMM-A-T42-60R	62	59	62	59	49	12
EAMM-A-T42-60RA	62	59	62	59	49	12
EAMM-A-T42-80P	82	59	82	59	64.1	12
EAMM-A-T42-87A	86	59	86	59	45	12
EAMM-A-T46-57A	79	56.4	79	56.4	42	14
EAMM-A-T46-60P	62	79	62	79	47	33
EAMM-A-T46-60R	62	79	62	79	47	33
EAMM-A-T46-60RA	62	79	62	79	47	33
EAMM-A-T46-70A	79	79	79	79	42	–
EAMM-A-T46-70AA	79	79	79	79	47	–
EAMM-A-T46-80P	79	79	79	79	63.1	–
EAMM-A-T46-80PA	79	79	79	79	68.5	–
EAMM-A-T46-80PB	79	79	79	79	68.5	–
EAMM-A-T46-85AA	85	79	85	79	55	14
EAMM-A-T46-87A	86	79	86	79	44	12
EAMM-A-T46-100A	100	79	100	79	68.1	22

Datasheet

Dimensions (sample illustration)

Download CAD data → www.festo.com

EGSK...

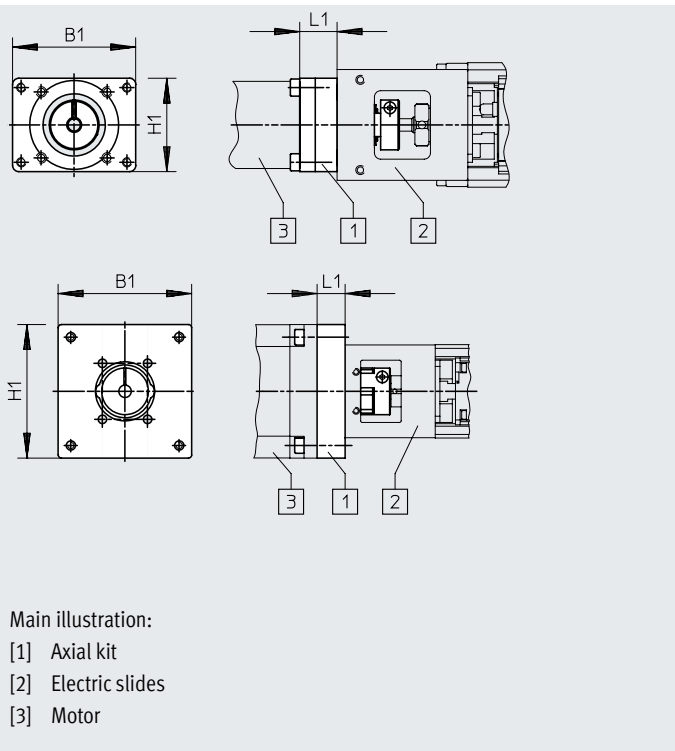

Type	B1	H1	L1
EAMM-A-P3-28D-28A	30	30	15
EAMM-A-P3-28D-40P	39.7	39.7	14.5
EAMM-A-P4-28B-28A	39.6	30	12
EAMM-A-P4-28B-38AA	38	38	17.5
EAMM-A-P4-28B-40A	40	40	8.3
EAMM-A-P4-28B-40P	39.7	39.7	12.5
EAMM-A-P4-28B-40R	40	40	17.5
EAMM-A-P4-28B-40RA	40	40	10.5
EAMM-A-P4-28B-42A	42	42	16.5
EAMM-A-P5-28B-28A	39.6	30	12
EAMM-A-P5-28B-38AA	38	38	17.5
EAMM-A-P5-28B-40A	40	40	8.3
EAMM-A-P5-28B-40P	39.7	39.7	12.5
EAMM-A-P5-28B-40R	40	40	17.5
EAMM-A-P5-28B-40RA	40	40	10.5
EAMM-A-P5-28B-42A	42	42	16.5
EAMM-A-P6-38A-40A	50	50	9
EAMM-A-P6-38A-40G	60	60	17
EAMM-A-P6-38A-40P	50	50	10.7
EAMM-A-P6-38A-42A	55	55	15
EAMM-A-P6-38A-55A	55	55	11
EAMM-A-P6-38A-57A	56	56	11
EAMM-A-P6-38A-58AA	58	58	10.6
EAMM-A-P6-38A-60P	61.4	61.4	21
EAMM-A-P6-38A-60R	61.4	61.4	21
EAMM-A-P6-38A-60RA	61.4	61.4	21
EAMM-A-P8-38A-40A	50	50	9
EAMM-A-P8-38A-40G	60	60	17
EAMM-A-P8-38A-40P	50	50	10.7
EAMM-A-P8-38A-42A	55	55	15
EAMM-A-P8-38A-55A	55	55	11
EAMM-A-P8-38A-57A	56	56	11
EAMM-A-P8-38A-58AA	58	58	10.6
EAMM-A-P8-38A-60AA	60	60	11.5
EAMM-A-P8-38A-60P	61.4	61.4	21
EAMM-A-P8-38A-60R	62	62	11.8
EAMM-A-P8-38A-60RA	62	62	11.8
EAMM-A-P8-38A-70A	70	70	13.8
EAMM-A-P8-38A-70AA	70	70	13.75
EAMM-A-P8-38A-87A	85.8	85.8	18
EAMM-A-P10-38A-40G	60	60	17
EAMM-A-P10-38A-55A	55	55	11
EAMM-A-P10-38A-57A	56	56	11
EAMM-A-P10-38A-60P	61.4	61.4	21
EAMM-A-P10-38A-70A	70	70	13.8
EAMM-A-P10-38A-87A	85.8	85.8	18

Datasheet

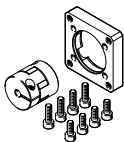
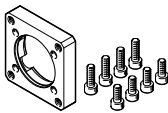
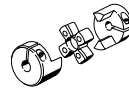
Ordering data – Individual components		
Axial kit	Consisting of:	
	Motor flange	Coupling
		
Part no. Type	Part no. Type	Part no. Type
1703478 EAMM-A-P3-28D-28A	1087613 EAMF-A-28D-28A	562672 EAMC-16-20-3-5
1982886 EAMM-A-P3-28D-40P	1982014 EAMF-A-28D-40P	2310368 EAMC-16-20-3-8
1731466 EAMM-A-P4-28B-28A	1704476 EAMF-A-28B-28A	562674 EAMC-16-20-4-5
1983071 EAMM-A-P4-28B-40P	1976704 EAMF-A-28B-40P	562675 EAMC-16-20-4-8
562637 EAMM-A-P4-28B-40A	552163 EAMF-A-28B-40A	562673 EAMC-16-20-4-6
562636 EAMM-A-P4-28B-42A	552164 EAMF-A-28B-42A	562674 EAMC-16-20-4-5
1731474 EAMM-A-P5-28B-28A	1704476 EAMF-A-28B-28A	562676 EAMC-16-20-5-5
562641 EAMM-A-P5-28B-40A	552163 EAMF-A-28B-40A	543419 EAMC-16-20-5-6
1983122 EAMM-A-P5-28B-40P	1976704 EAMF-A-28B-40P	562677 EAMC-16-20-5-8
562640 EAMM-A-P5-28B-42A	552164 EAMF-A-28B-42A	562676 EAMC-16-20-5-5
562646 EAMM-A-P6-38A-40A	562667 EAMF-A-38A-40A	558312 EAMC-30-32-6-6
2297645 EAMM-A-P6-38A-40G	1460097 EAMF-A-38A-40G	562681 EAMC-30-32-6-10
1983450 EAMM-A-P6-38A-40P	1984478 EAMF-A-38A-40P	533708 EAMC-30-32-6-8
562644 EAMM-A-P6-38A-42A	562668 EAMF-A-38A-42A	561333 EAMC-30-32-5-6
562647 EAMM-A-P6-38A-55A	558176 EAMF-A-38A-55A	551003 EAMC-30-32-6-9
562645 EAMM-A-P6-38A-57A	560692 EAMF-A-38A-57A	551002 EAMC-30-32-6-6.35
2264375 EAMM-A-P6-38A-60P	1987412 EAMF-A-38A-60P	1233256 EAMC-30-32-6-14

Datasheet

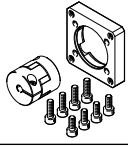
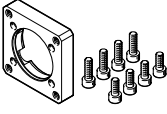
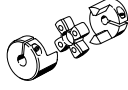
Ordering data – Individual components		
Axial kit	Consisting of:	
	Motor flange	Coupling
		
Part no. Type	Part no. Type	Part no. Type
562652 EAMM-A-P8-38A-40A	562667 EAMF-A-38A-40A	533708 EAMC-30-32-6-8
2297646 EAMM-A-P8-38A-40G	1460097 EAMF-A-38A-40G	558029 EAMC-30-32-8-10
1986292 EAMM-A-P8-38A-40P	1984478 EAMF-A-38A-40P	543422 EAMC-30-32-8-8
562650 EAMM-A-P8-38A-42A	562668 EAMF-A-38A-42A	562678 EAMC-30-32-5-8
562653 EAMM-A-P8-38A-55A	558176 EAMF-A-38A-55A	543423 EAMC-30-32-8-9
562651 EAMM-A-P8-38A-57A	560692 EAMF-A-38A-57A	543421 EAMC-30-32-6.35-8
1987308 EAMM-A-P8-38A-60P	1987412 EAMF-A-38A-60P	562682 EAMC-30-32-8-14
564996 EAMM-A-P8-38A-70A	558018 EAMF-A-38A-70A	551004 EAMC-30-32-8-11
564998 EAMM-A-P8-38A-87A	560693 EAMF-A-38A-87A	551004 EAMC-30-32-8-11
2297648 EAMM-A-P10-38A-40G	1460097 EAMF-A-38A-40G	2310372 EAMC-30-32-10-10
562659 EAMM-A-P10-38A-55A	558176 EAMF-A-38A-55A	562680 EAMC-30-32-9-10
562658 EAMM-A-P10-38A-57A	560692 EAMF-A-38A-57A	562679 EAMC-30-32-6.35-10
2036017 EAMM-A-P10-38A-60P	1987412 EAMF-A-38A-60P	562683 EAMC-30-32-10-14
564997 EAMM-A-P10-38A-70A	558018 EAMF-A-38A-70A	565008 EAMC-30-32-10-11
564999 EAMM-A-P10-38A-87A	560693 EAMF-A-38A-87A	565008 EAMC-30-32-10-11

Datasheet

Dimensions (sample illustration)

Download CAD data → www.festo.com

ELGG-..., ELGR-...

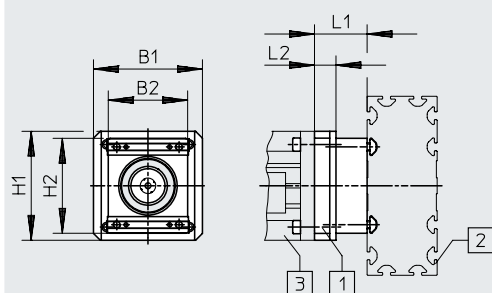



Main illustration:

- [1] Axial kit
- [2] Toothed belt axis
- [3] Motor

Type	B1	B2	H1	H2	L1	L2
EAMM-A-R27-40G	60	44.5	60	48.3	32	17
EAMM-A-R27-55A	55	44.5	55	48.3	26	11
EAMM-A-R27-57A	56	44.5	56	48.3	26	11
EAMM-A-R38-40G	60	51	60	61	37	17
EAMM-A-R38-57A	56	–	–	–	31	–
EAMM-A-R38-60G	60	51	60	61	46	26
EAMM-A-R38-60H	60	51	60	61	46	26
EAMM-A-R38-60P	61.4	51	61.4	61	41	21
EAMM-A-R38-70A	70	51	70	61	33.8	13.8
EAMM-A-R38-87A	85.8	51	85.8	61	38	18
EAMM-A-R48-60G	60	55	60	81	52.5	24.5
EAMM-A-R48-60H	60	55	60	51	52.5	24.5
EAMM-A-R48-70A	70	–	–	–	40.2	–
EAMM-A-R48-80P	81.3	55	81.3	81	54	26
EAMM-A-R48-87A	85.8	55	85.8	81	44	16
EAMM-A-R48-100A	100.5	55	100.5	81	59	31

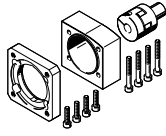
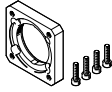
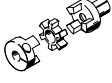
Datasheet

Ordering data – Individual components			
Axial kit	Consisting of:		
	Motor flange	Coupling	Coupling housing
			
Part no. Type	Part no. Type	Part no. Type	Part no. Type
1456622 EAMM-A-R27-40G	14600097 EAMF-A-38A-40G	557998 EAMD-19-15-10-8X10	1133397 EAMK-A-R27-38A
1133400 EAMM-A-R27-55A	558176 EAMF-A-38A-55A	557999 EAMD-19-15-9-8X10	1133397 EAMK-A-R27-38A
★ 1133403 EAMM-A-R27-57A	560692 EAMF-A-38A-57A	561292 EAMD-16-15-6.35-8X10	1133397 EAMK-A-R27-38A
1456623 EAMM-A-R38-40G	1460097 EAMF-A-38A-40G	1453860 EAMD-25-22-10-10X12	1133398 EAMK-A-R38-38A
★ 1578138 EAMM-A-R38-57A	560692 EAMF-A-38A-57A	561293 EAMD-25-22-6.35-10X12	1133398 EAMK-A-R38-38A
2310075 EAMM-A-R38-60G	558017 EAMF-A-38A-60G/H	558000 EAMD-25-22-11-10X12	1133398 EAMK-A-R38-38A
1456630 EAMM-A-R38-60H	558017 EAMF-A-38A-60G/H	1453861 EAMD-28-22-14-10X12	1133398 EAMK-A-R38-38A
★ 2224996 EAMM-A-R38-60P	1987412 EAMF-A-38A-60P	1453861 EAMD-28-22-14-10X12	1133398 EAMK-A-R38-38A
1133401 EAMM-A-R38-70A	558018 EAMF-A-38A-70A	558000 EAMD-25-22-11-10X12	1133398 EAMK-A-R38-38A
★ 1133404 EAMM-A-R38-87A	560693 EAMF-A-38A-87A	558000 EAMD-25-22-11-10X12	1133398 EAMK-A-R38-38A
2374780 EAMM-A-R48-60G	558019 EAMF-A-48A-60G/H	558001 EAMD-32-32-11-16X20	1133399 EAMK-A-R48-48A
1456633 EAMM-A-R48-60H	558019 EAMF-A-48A-60G/H	1377840 EAMD-32-32-14-16X20	1133399 EAMK-A-R48-48A
1578139 EAMM-A-R48-70A	558025 EAMF-A-48A-70A	558001 EAMD-32-32-11-16X20	1133399 EAMK-A-R48-48A
★ 2225090 EAMM-A-R48-80P	2043427 EAMF-A-48A-80P	558002 EAMD-42-40-19-16X25	1133399 EAMK-A-R48-48A
★ 1133405 EAMM-A-R48-87A	560695 EAMF-A-48A-87A	558001 EAMD-32-32-11-16X20	1133399 EAMK-A-R48-48A
★ 1133402 EAMM-A-R48-100A	558020 EAMF-A-48A-100A	558002 EAMD-42-40-19-16X25	1133399 EAMK-A-R48-48A

Festo Core Range



Generally ready for shipping ex works in 24 hours



Generally ready for shipping ex works in 5 days

Datasheet

Dimensions (sample illustration)

Download CAD data → www.festo.com

EXCM-..., EXCH-...

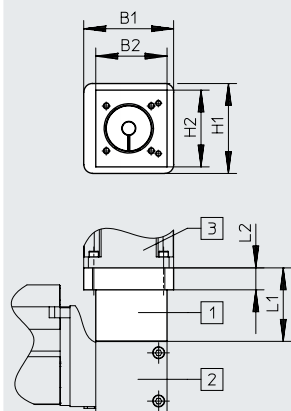

Main illustration:

- [1] Axial kit
- [2] Planar surface gantry
- [3] Motor

Type	Type	B1	B2	H1	H2	L1	L2
EAMM-A-X48-57A	EXCM-40	70	70	70	70	53.6	–
EAMM-A-X48-80P	EXCH-40	82	70	82	65	67	20
EAMM-A-X62-100A	EXCH-60	104	100	104	90.5	62	22
EAMM-A-X62-150A	EXCH-60	151	100	151	90.5	71.5	29

Dimensions (sample illustration)

Download CAD data → www.festo.com

EXCT-...,

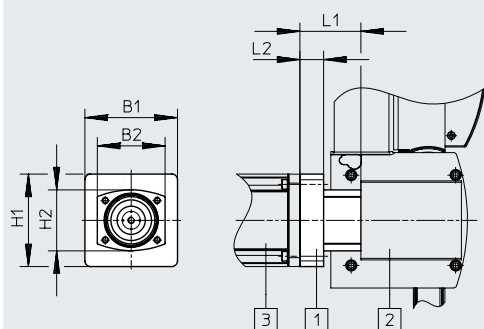

Main illustration:

- [1] Axial kit
- [2] Linear gantry
- [3] Motor

Type	Type	B1	B2	H1	H2	L1	L2
EAMM-A-Y62-100A	EXCT-30	104	92	104	79	62.5	24

Accessories

Seal set

Contains paint-wetting impairment substances
RoHS-compliant

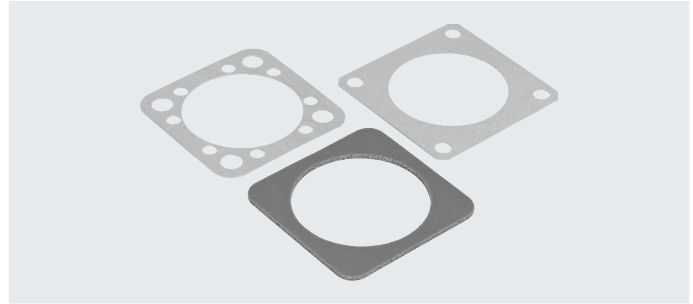

Ordering data						
Type	For axial kit	For electric cylinder	Ambient temperature [°C]	CRC ¹⁾	Part no.	Type
EADS-F-D32-40A	EAMM-A-D32-40A	ESBF, EGSL, ERMB, ERMH	-25 ... +60	4	1561526	EADS-F-D32-40A
EADS-F-D32-40G	EAMM-A-D32-40G				2253500	EADS-F-D32-40G
EADS-F-D32-40P	EAMM-A-D32-40P				2207219	EADS-F-D32-40P
EADS-F-D32-60G/H	EAMM-A-D32-60G EAMM-A-D32-60H				8022150	EADS-F-D32-60G/H
EADS-F-D32-60P	EAMM-A-D32-60P				2234012	EADS-F-D32-60P
EADS-F-D32-42A	EAMM-A-D32-42A				1561527	EADS-F-D32-42A
EADS-F-D32-55A	EAMM-A-D32-55A				1561528	EADS-F-D32-55A
EADS-F-D32-57A	EAMM-A-D32-57A				1561529	EADS-F-D32-57A
EADS-F-D40-55A	EAMM-A-D40-55A				1561530	EADS-F-D40-55A
EADS-F-D40-57A	EAMM-A-D40-57A				1561531	EADS-F-D40-57A
EADS-F-D40-60G/H	EAMM-A-D40-60G EAMM-A-D40-60H				2253503	EADS-F-D40-60G/H
EADS-F-D40-60P	EAMM-A-D40-60P				2151545	EADS-F-D40-60P
EADS-F-D40-70A	EAMM-A-D40-70A				1561532	EADS-F-D40-70A
EADS-F-D40-87A	EAMM-A-D40-87A				1561533	EADS-F-D40-87A
EADS-F-D50-60G/H	EAMM-A-D50-60G EAMM-A-D50-60H				2733792	EADS-F-D50-60G/H
EADS-F-D50-70A	EAMM-A-D50-70A				2733789	EADS-F-D50-70A
EADS-F-D50-80G	EAMM-A-D50-80G				2733793	EADS-F-D50-80G
EADS-F-D50-80P	EAMM-A-D50-80P				2733791	EADS-F-D50-80P
EADS-F-D50-87A	EAMM-A-D50-87A				2733788	EADS-F-D50-87A
EADS-F-D50-100A	EAMM-A-D50-100A				2733790	EADS-F-D50-100A
EADS-F-D60-70A	EAMM-A-D60-70A				8022145	EADS-F-D60-70A
EADS-F-D60-80G	EAMM-A-D60-80G				8022146	EADS-F-D60-80G
EADS-F-D60-60G/H	EAMM-A-D60-60H				2253505	EADS-F-D60-60G/H
EADS-F-D60-80P	EAMM-A-D60-80P				2218523	EADS-F-D60-80P
EADS-F-D60-87A	EAMM-A-D60-87A				1561536	EADS-F-D60-87A
EADS-F-D60-100A	EAMM-A-D60-100A				2253507	EADS-F-D60-100A
EADS-F-D80-80G	EAMM-A-D80-80G				8022147	EADS-F-D80-80G
EADS-F-D80-100A	EAMM-A-D80-100A	1593617	EADS-F-D80-100A			
EADS-F-D80-150A	EAMM-A-D80-150A	8162067	EADS-F-D80-150A			
EADS-F-D100-100A	EAMM-A-D100-100A	3356966	EADS-F-D100-100A			
EADS-F-D100-120G	EAMM-A-D100-120G	8022148	EADS-F-D100-120G			
EADS-F-D100-150A	EAMM-A-D100-150A	8162068	EADS-F-D100-150A			

1) Corrosion resistance class CRC 4 to Festo standard FN 940070
Particularly high corrosion stress. Outdoor exposure under extreme corrosive conditions. Parts exposed to aggressive media, e.g. in the chemical or food industries. These applications may need to be supported with special tests (→ auch FN 940082) using appropriate media.