

Planar surface gantries

FESTO

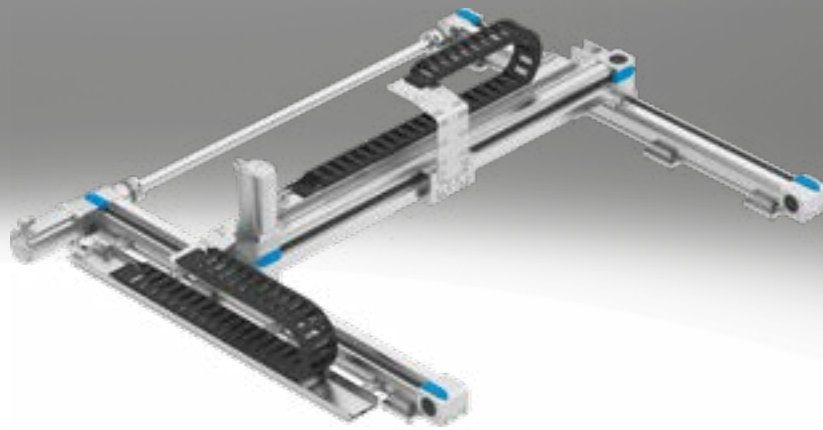

Characteristics

At a glance

The planar surface gantry facilitates movement in 2D space. Depending on the requirements, the gantry is either composed of several axis modules (YXCF) or using the planar surface gantries EXCM or EXCH (YXMF). All of these are tried-and-tested components from Festo.

- Can be used universally for light to very heavy workpieces or high payloads
- Especially suitable for very long strokes
- High mechanical rigidity and sturdy design
- Freely positionable/any intermediate positions

Range of applications:

- For any movements in 2D space
- Very high requirements for precision and/or very heavy workpieces combined with long strokes (YXCR)
- Cost-effective handling unit in a compact format for small parts handling and simple tasks (YXCR-B)

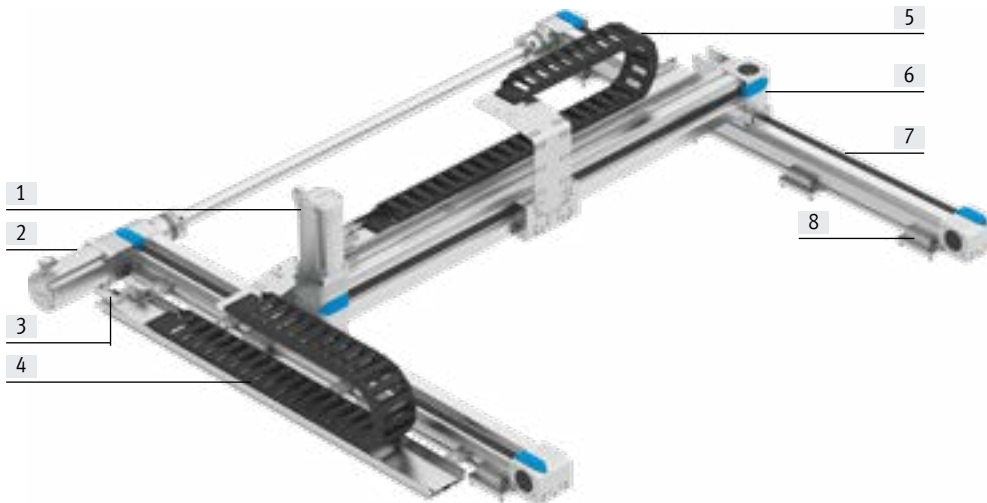

- [1] Servo motor for the Y-module
- [2] Servo motor for the X-module
- [3] Multi-pin plug distributor which collectively transfers all electrical signals such as for end-position sensing
- [4] Energy chain for the X-module
- [5] Energy chain for the Y-module
- [6] Y-axis
- [7] X-axis
- [8] Profile mounting/adjusting kit

Description of the modules

X-module

Design:

Depending on the configuration, the X-module comprises either two drive axes joined together by a connecting shaft (YXCF) or one drive axis + separate guide axis (YXCF-B).

They are powered by a servo or stepper motor.

Adapters are mounted on the slides of the X-axes to connect the Y-module.

The position of the motor and energy chain can be selected using the configurator.

The following components are located on the motor side:

- Energy chain (optional)
- Multi-pin plug distributor for proximity switch (if a sensor package has been selected)

Sample image:

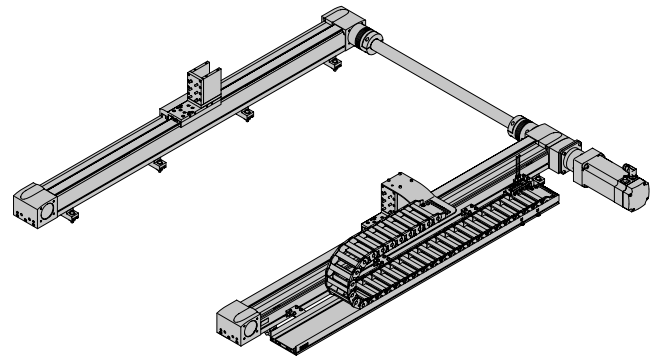

Characteristics

Description of the modules

Y-module

Design:

The Y-module EHMV comprises a linear axis which is powered by a servo or stepper motor.

The position of the motor and energy chain is dependent on the position of the motor on the X-module.

The following components are located on the motor side:

- Energy chain (optional)
- Multi-pin plug distributor for proximity switch (if a sensor package has been selected)

Sample image:

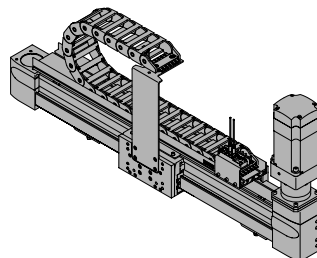

XY-module (EXCM, EXCH)

Design:

A slide is moved in a two-dimensional space (X-axis/Y-axis) via a toothed belt. The system is powered by two fixed motors. The motors are coupled to the toothed belt. The belt is guided by pulleys so that the slide can move to any position in a working space when the motors are actuated.

When using attachment components, additional processes can be carried out by independent Z-axes.

Sample image:

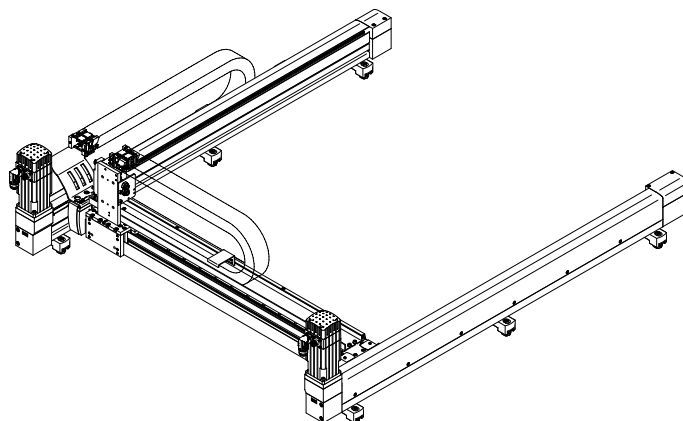

Dispatch options

Fully assembled:

The planar surface gantry is fully assembled. All cables are installed and connected. The system is already set up on delivery, but must be adapted to the particular mounting surface during installation.

Note flatness → table below.

Partially assembled:

The planar surface gantry is delivered partially assembled. This means that both axis modules (X-/Y-axis) are assembled, each with optional motors. The partially assembled system must be completed by the customer. Help can be found in the assembly instructions provided.

Optional accessories (→ page 10) are enclosed.

Note flatness → table below.

System overview ¹⁾							
Size	YXCF-1	YXCF-2	YXCF-3	YXCF-4	YXMF-1	YXMF-2	YXMF-3
Max. working stroke	X: 1900 mm Y: 1800 mm	X: 3000 mm Y: 1820 mm	X: 3000 mm Y: 1755 mm	X: 3000 mm Y: 1640 mm	X: 700 mm Y: 510 mm	X: 2000 mm Y: 1000 mm	X: 2500 mm Y: 1500 mm
Max. payload	Dependent on the selected dynamic response						
Required flatness of the mounting surface	≤ 0.1 mm/m						
Mounting position	Horizontal						

Size	YXCF-1-B	YXCF-2-B
Max. working stroke	X: 800 mm Y: 600 mm	X: 1000 mm Y: 800 mm
Max. payload	Dependent on the selected dynamic response	
Required flatness of the mounting surface	≤ 0.1 mm/m	
Mounting position	Horizontal	

1) Drive package depends on the configuration selected.

Characteristics

Configurator: Handling Guide Online (HGO)

Selecting a handling system

Planning complex handling systems takes a lot of time. You can use the configurator "Handling Guide Online" (HGO) to design a customised handling system for your application in just a few steps.

You can choose from the following systems:

- Single-axis system
- 2D linear gantry
- 2D planar surface gantry
- 3-dimensional gantry
- 3D cantilever system

Advantages:

- Automatic selection of all relevant components
- Automatic design and calculation of the workload
- Quote created automatically
- CAD model available immediately
- Configuration-specific parameters for servo drives available immediately
- Complete Eplan project can be ordered according to the individual configuration
- Fully automated processing
- You can order fully or partially assembled systems through the Online Shop
- Lots of possible options

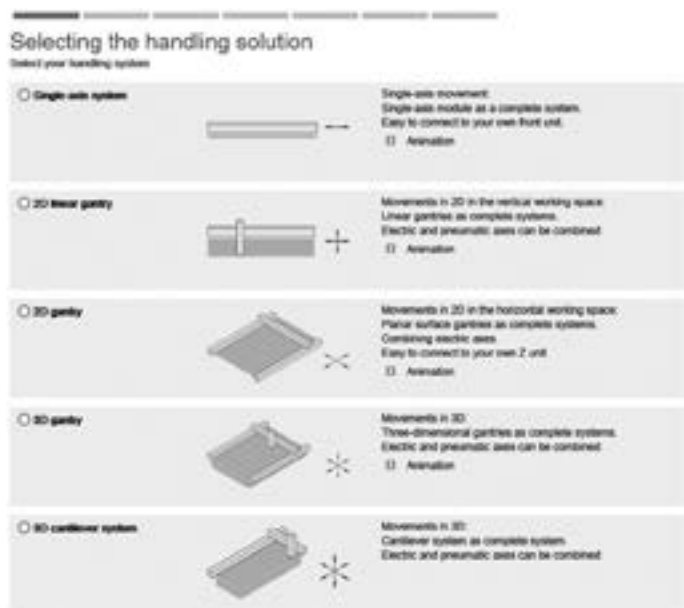

Entering the application data

- Payload
- Drive system of the axis
- Distance from the centre of the load
- Working stroke
- Reference cycle

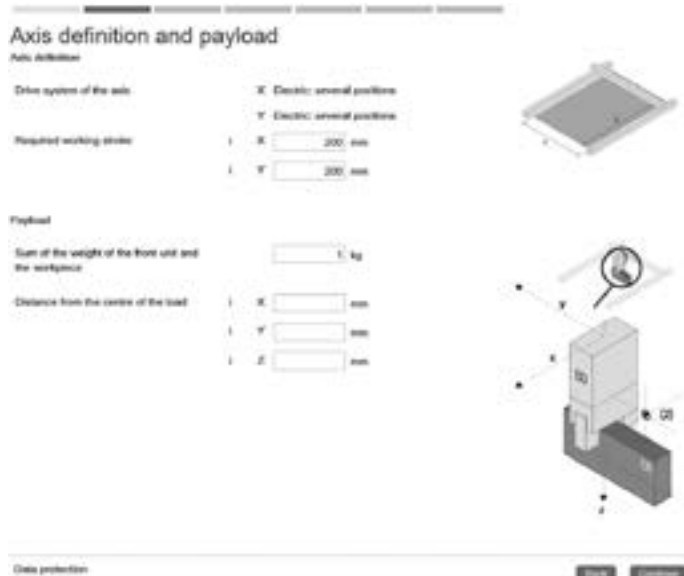

Characteristics

Configurator: Handling Guide Online (HGO)

Result of calculation

You will be offered a selection of systems calculated based on the application data you entered.

The following are available immediately:

- CAD model
- Datasheet of the selected system
- Price information

Result of calculation
Select the appropriate system and confirm with the configuration.

No.	System name	System workload ()	Repetition accuracy (H)	Your price
<input checked="" type="checkbox"/>	1 Y00F-1	75 %	0.05 mm	
<input type="checkbox"/>	2 Y00F-1	20 %	0.11 mm	
<input type="checkbox"/>	3 Y00F-2	72 %	0.11 mm	
<input type="checkbox"/>	7 Y00F-2	75 %	0.11 mm	
<input type="checkbox"/>	8 Y00F-2	8 %	0.11 mm	

2D gantry Y00F-1-81

Drive module	XY module Planar surface gantry ECOM-30
Kinematics type	Parallel kinematics
Stroke	100 mm X 20 mm
Repetition accuracy (H)	-
Clear wall	Without
Type of motor	Stepper motor EMMS-1T
Motor position	Underneath
Motor controller	CM204-572

Data protection Back Continue

System overview

You will be given an overview of the complete system.

You will also have the following options:

- Show price
- Send request
- Add to basket

Your handling solution
Your selected system overview

Exemplary representation



3D gantry Y00F-1-81

Your system ID: C1374165

Your next steps:

- Show price
- Send request
- Add to basket

Your system overview

Features	Value
Handling type	2D gantry
Payload	2 kg
Drive system of the X-axis	Electric, several positions
Drive system of the Y-axis	Electric, several positions

Data protection Back

Characteristics

Standard components within the handling system

The handling system comprises a number of tried-and-tested standard components from Festo. Different components are used depending on the configuration. The single axes installed will be displayed in the configurator HGO on the "Result of calculation" page.

Drives/axes

X-axis

Toothed belt axis EGC-TB-KF



- Electric
- Rigid, closed profile
- Recirculating ball bearing guide for high loads and torques
- High dynamic response and minimum vibration

Spindle axis ELGC-BS



- Electric
- Optimal installation space to working space ratio
- Protected against external influences by internal guide
- Various spindle pitches

Guide axis ELFC



- Driveless linear guide unit with guide and freely movable slide unit
- The guide axis is designed to support forces and torques in multi-axis applications

Y-axis

Toothed belt axis EGC-TB-KF



- Electric
- Rigid, closed profile
- Recirculating ball bearing guide for high loads and torques
- High dynamic response and minimum vibration

Spindle axis ELGC-BS



- Electric
- Optimal installation space to working space ratio
- Protected against external influences by internal guide
- Various spindle pitches

Toothed belt axis EGC-HD-TB



- Electric
- Flat drive unit with rigid, closed profile
- Duo guide rail
- For maximum loads and torques, high feed forces and speeds and long service life

Characteristics

Possible axis combinations ¹⁾		
Size	X-module	Y-module
YXCF-1	<ul style="list-style-type: none"> Toothed belt axis EGC-50-TB-KF 	<ul style="list-style-type: none"> Toothed belt axis EGC-50-TB-KF
YXCF-1-B	<ul style="list-style-type: none"> Spindle axis ELGC-60-BS 	<ul style="list-style-type: none"> Spindle axis ELGC-45-BS Spindle axis ELGC-60-BS
YXCF-2	<ul style="list-style-type: none"> Toothed belt axis EGC-80-TB-KF 	<ul style="list-style-type: none"> Toothed belt axis EGC-80-TB-KF Toothed belt axis with heavy-duty guide EGC-HD-125-TB
YXCF-2-B	<ul style="list-style-type: none"> Spindle axis ELGC-80-BS 	<ul style="list-style-type: none"> Spindle axis ELGC-60-BS Spindle axis ELGC-80-BS
YXCF-3	<ul style="list-style-type: none"> Toothed belt axis EGC-120-TB-KF 	<ul style="list-style-type: none"> Toothed belt axis EGC-120-TB-KF Toothed belt axis with heavy-duty guide EGC-HD-160-TB
YXCF-4	<ul style="list-style-type: none"> Toothed belt axis EGC-185-TB-KF 	<ul style="list-style-type: none"> Toothed belt axis EGC-185-TB-KF Toothed belt axis with heavy-duty guide EGC-HD-220-TB
YXMF-1	<ul style="list-style-type: none"> Planar surface gantry EXCM-30 	<ul style="list-style-type: none"> Planar surface gantry EXCM-30
YXMF-2	<ul style="list-style-type: none"> Planar surface gantry EXCM-40, EXCH-40 	<ul style="list-style-type: none"> Planar surface gantry EXCM-40, EXCH-40
YXMF-3	<ul style="list-style-type: none"> Planar surface gantry EXCH-60 	<ul style="list-style-type: none"> Planar surface gantry EXCH-60

1) Drive package depends on the configuration selected.

Characteristics

Standard components within the handling system

The handling system comprises a number of tried-and-tested standard components from Festo. Different components are used depending on the configuration. You can alter the scope and design of the drive package in the configurator HGO on the "System configuration" page.

Motors and controllers

Servo motors EMMT-AS



- Dynamic, brushless, permanently excited servo motor
- Digital absolute displacement encoder in single-turn or multi-turn version
- With optional brake

Servo motors EMME-AS



- Dynamic, brushless, permanently excited servo motor
- Digital absolute displacement encoder in single-turn or multi-turn version
- With optional brake

Servo motors EMMB-AS



- Dynamic, brushless, permanently excited servo motor
- Digital absolute displacement encoder in single-turn or multi-turn version
- With optional brake

Stepper motors EMMS-ST



- 2-phase hybrid technology
- Step angle 1.8°
- With optional brake

Gear unit EMGA



- Low-backlash planetary gear
- Gear ratio
 $i = 3$ and 5
- Life-time lubrication

Characteristics

Standard components within the handling system

The handling system comprises a number of tried-and-tested standard components from Festo. Different components are used depending on the configuration. You can alter the scope and design of the drive package in the configurator HGO on the "System configuration" page.

Servo drive CMMT-AS, for servo motor



- Universal servo drive
- For synchronous servo motors
- Integrated EMC filters
- Integrated brake chopper
- Integrated braking resistor
- Position controller
- Speed controller
- Force controller
- Range of control functions

Options:

- Safety function: safe torque off (STO)/category 4, Performance Level e
- Safe stop 1 (SS1)
- Safe brake control (SBC) up to SIL3/category 3, Performance Level e

- Bus protocols
 - EtherCAT
 - PROFINET RT/IRT
 - EtherNet/IP
 - Modbus TCP

Servo drive CMMT-ST, for stepper motor



- Servo drive for operating stepper motors and brushless direct current motors
- Options for point-to-point and interpolating motion and for precise positioning
- Primary voltage from 24 ... 48 V DC
- Position controller
- Speed controller
- Force controller
- Range of control functions

Options:

- Safety function: safe torque off (STO)/category 3, Performance Level e
- Safe stop 1 time controlled (SS1-t)

- Bus protocols
 - EtherCAT
 - PROFINET RT/IRT
 - EtherNet/IP
 - Modbus TCP

Ordering data – Accessories

Module/motor combinations

We recommend that the planar surface gantry is operated with the proposed motors from Festo. These precisely match the mechanical system. When using third-party motors, it is essential that the technical limits are observed.

Module	Motor		Stepper motor	
	Servo motor			
X-module				
EHM-EGC-50-TB-KF	–	EMME-AS-40-M-LV-...	–	EMMS-ST-42-S-...
EHM-EGC-80-TB-KF	EMMT-AS-60-L-LS-...	EMME-AS-60-M-LS-...	–	EMMS-ST-57-S-...
	EMMT-AS-100-M-HS-...			
EHM-EGC-120-TB-KF	EMMT-AS-80-L-LS-...	EMME-AS-80-S-LS-...	–	–
	EMMT-AS-80-L-HS-...			
EHM-EGC-185-TB-KF	EMMT-AS-100-L-HS-...	–	–	–
	EMMT-AS-100-H-HS-...	–	–	–
	EMMT-AS-150-M-HS-R2...	–	–	–
EHM-ELGC-60-BS	–	–	EMMB-AS-80-07	EMMS-ST-57-M
EHM-ELGC-80-BS	–	–	EMMB-AS-80-07	EMMS-ST-87-M
Y-module				
EHY-...-EGC-50-TB-KF	–	EMME-AS-40-S-LV-...	–	EMMS-ST-57-M-...
EHY-...-EGC-80-TB-KF	EMMT-AS-60-S-LS-...	EMME-AS-60-M-LS-...	–	EMMS-ST-57-S-...
EHY-...-EGC-120-TB-KF	EMMT-AS-80-L-LS-...	EMME-AS-80-S-LS-...	–	EMMS-ST-87-S-...
	EMMT-AS-80-L-HS-...			
EHY-...-EGC-125-TB-HD	EMMT-AS-60-L-LS-...	EMME-AS-60-M-LS-...	–	EMMS-ST-57-S-...
EHY-...-EGC-160-TB-HD	EMMT-AS-80-M-LS-...	EMME-AS-80-S-LS-...	–	EMMS-ST-87-S-...
	EMMT-AS-80-L-HS-...			
EHY-...-EGC-185-TB-KF	EMMT-AS-100-L-HS-...	EMME-AS-100-M-HS-...	–	–
	EMMT-AS-100-H-HS-...	–	–	–
EHY-...-EGC-220-TB-HD	EMMT-AS-100-L-HS-...	EMME-AS-100-M-HS-...	–	–
	EMMT-AS-100-H-HS-...	–	–	–
EHY-RP-ELGC-45-BS	–	–	EMMB-AS-40-01	EMMS-ST-42-S
EHY-RP-ELGC-60-BS	–	–	EMMB-AS-60-04	EMMS-ST-57M
EHY-RP-ELGC-80-BS	–	–	EMMB-AS-60-04	EMMS-ST-87-M
XY-module (EXCM, EXCH)				
EXCM-30	–	–	–	EMMS-ST-42-S-...
EXCM-40	–	–	–	EMMS-ST-57-M-...
EXCH-40	EMMT-AS-80-M-LS-...	–	–	–
EXCH-40	EMMT-AS-80-L-HS-...	–	–	–
EXCH-60	EMMT-AS-100-M-HS-...	–	–	–
	EMMT-AS-150-M-HV-R3...	–	–	–

Ordering data – Accessories

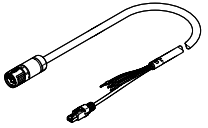
Ordering data	Description	Cable length [m]	Part no.	Type
For servo motor EMMT-AS				
Motor cable				
	• For EMMT-AS-60/80-...-R2... with CMMT-AS	2.5	5251374	NEBM-M23G15-EH-2.5-Q7N-R3LEG14
		5	5251375	NEBM-M23G15-EH-5-Q7N-R3LEG14
		7.5	5251376	NEBM-M23G15-EH-7.5-Q7N-R3LEG14
		10	5251377	NEBM-M23G15-EH-10-Q7N-R3LEG14
		15	5251378	NEBM-M23G15-EH-15-Q7N-R3LEG14
	• For EMMT-AS-100-...-R2... with CMMT-AS • For EMMT-AS-150-...-R2... with CMMT-AS	2.5	5251381	NEBM-M23G15-EH-2.5-Q9N-R3LEG14
		5	5251382	NEBM-M23G15-EH-5-Q9N-R3LEG14
		7.5	5251383	NEBM-M23G15-EH-7.5-Q9N-R3LEG14
		10	5251384	NEBM-M23G15-EH-10-Q9N-R3LEG14
		15	5251385	NEBM-M23G15-EH-15-Q9N-R3LEG14
	• For EMMT-AS-150-...-R3... with CMMT-AS	2.5	5251395	NEBM-M40G15-EH-2.5-Q11N-R3LEG14
		5	5251396	NEBM-M40G15-EH-5-Q11N-R3LEG14
		7.5	5251397	NEBM-M40G15-EH-7.5-Q11N-R3LEG14
		10	5251398	NEBM-M40G15-EH-10-Q11N-R3LEG14
		15	5251399	NEBM-M40G15-EH-15-Q11N-R3LEG14
		20	5251400	NEBM-M40G15-EH-20-Q11N-R3LEG14

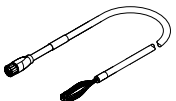
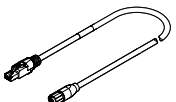

Ordering data	Description	Cable length [m]	Part no.	Type
For servo motor EMME-AS				
Motor cable				
	• For EMME-AS-40/60 with CMMT-AS	2.5	5391541	NEBM-M16G8-E-2.5-Q7-LE8-1
		5	5391543	NEBM-M16G8-E-5-Q7-LE8-1
		7.5	5391548	NEBM-M16G8-E-7.5-Q7-LE8-1
		10	8085952	NEBM-M16G8-E-10-Q7-LE8-1
		15	8085953	NEBM-M16G8-E-15-Q7-LE8-1
	• For EMME-AS-80/100 with CMMT-AS	2.5	611113	NEBM-M16G8-E-20-Q7-LE8-1
		2.5	5391540	NEBM-M16G8-E-2.5-Q9-LE8-1
		5	5391545	NEBM-M16G8-E-5-Q9-LE8-1
		7.5	5391547	NEBM-M16G8-E-7.5-Q9-LE8-1
		10	5391549	NEBM-M16G8-E-10-Q9-LE8-1
		15	5391550	NEBM-M16G8-E-15-Q9-LE8-1
		20	611114	NEBM-M16G8-E-20-Q9-LE8-1
Encoder cable				
	• For EMME-AS-40/60/80/100 with CMMT-AS	2.5	5212312	NEBM-M12G8-E-2.5-N-R3G8
		5	5212313	NEBM-M12G8-E-5-N-R3G8
		7.5	5212314	NEBM-M12G8-E-7.5-N-R3G8
		10	5212315	NEBM-M12G8-E-10-N-R3G8
		15	5212316	NEBM-M12G8-E-15-N-R3G8
		20	611112	NEBM-M12G8-E-20-N-R3G8

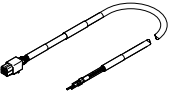
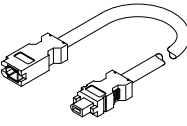
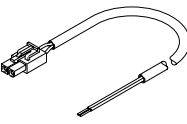
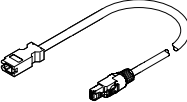
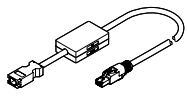
Ordering data – Accessories

Ordering data		Cable length [m]	Part no.	Type
For servo motor EMMB-AS				
Motor cable				
	• For EMMB-AS-40/60/80 with CMMT-AS	2.5	5219197	NEBM-H6G4-E-2.5-Q13N-LE4
		5	5219198	NEBM-H6G4-E-5-Q13N-LE4
		7.5	5219199	NEBM-H6G4-E-7.5-Q13N-LE4
		10	5219200	NEBM-H6G4-E-10-Q13N-LE4
		15	8097203	NEBM-H6G4-E-15-Q13N-LE4
Encoder cable				
	• For EMMB-AS-40/60/80 with CMMT-AS	2.5	5219213	NEBM-REG6-E-2.5-Q14N-REG6
		5	5219214	NEBM-REG6-E-5-Q14N-REG6
		7.5	5219215	NEBM-REG6-E-7.5-Q14N-REG6
		10	5219216	NEBM-REG6-E-10-Q14N-REG6
		15	8097200	NEBM-REG6-E-15-Q14N-REG6
Connecting cable for brake				
	• For EMMB-AS-40/60/80 with CMMT-AS	2.5	5219205	NEBM-H7G2-E-2.5-Q14N-LE2
		5	5219206	NEBM-H7G2-E-5-Q14N-LE2
		7.5	5219207	NEBM-H7G2-E-7.5-Q14N-LE2
		10	5219208	NEBM-H7G2-E-10-Q14N-LE2
		15	8097206	NEBM-H7G2-E-15-Q14N-LE2
Adapter for encoder cable (absolutely essential)				
	• For EMMB-AS-40/60/80 with CMMT-AS	For single-turn version with CMMT-AS		
		0.5	8097197	NEFM-REG6-K-0.5-R3G8
	• For EMMB-AS-40/60/80 with CMMT-AS	For multi-turn version with CMMT-AS¹⁾		
		0.5	8097195	NEFM-REG6-K-0.5-B-R3G8
		For multi-turn version with CMMB-AS¹⁾		
		0.5	8097196	NEFM-REG6-K-0.5-B-REG6

1) The required battery is not included in the scope of delivery

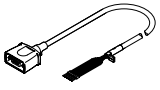
Ordering data – Accessories

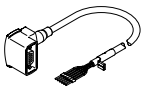
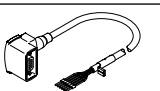
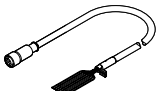
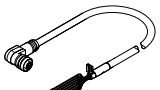
Designation	Description	Cable length [m]	Part no.	Type
For stepper motor EMMS-ST				
Motor cable¹⁾				
	<ul style="list-style-type: none"> For stepper motor EMMS-ST-42/57-...-G2 with CMMT-ST Straight plug 	2.5	1450369	NEBM-S1G9-E-2.5-Q5-LE6
		5	1450370	NEBM-S1G9-E-5-Q5-LE6
		7	1450371	NEBM-S1G9-E-7-Q5-LE6
		10	1450372	NEBM-S1G9-E-10-Q5-LE6
		15	5085055	NEBM-S1G9-E-15-Q5-LE6
		20	5085056	NEBM-S1G9-E-20-Q5-LE6
	<ul style="list-style-type: none"> For stepper motor EMMS-ST-42-...-SE-G3 with CMMT-ST Straight plug Motor to mechanics EXCM-30 	2.5	550326	NEBU-M12G5-K-2.5-LE4
		5.0	541328	NEBU-M12G5-K-5-LE4
	<ul style="list-style-type: none"> For stepper motor EMMS-ST-42/57-...-G2 with CMMT-ST Angled plug 	2.5	1450737	NEBM-S1W9-E-2.5-Q5-LE6
		5	1450738	NEBM-S1W9-E-5-Q5-LE6
		7	1450739	NEBM-S1W9-E-7-Q5-LE6
		10	1450740	NEBM-S1W9-E-10-Q5-LE6
		15	610856	NEBM-S1W9-E-15-Q5-LE6
	<ul style="list-style-type: none"> For stepper motor EMMS-ST-87-...-G2 with CMMT-ST Angled plug 	2.5	1450944	NEBM-S1W15-E-2.5-Q7-LE6
		5.0	1450945	NEBM-S1W15-E-5-Q7-LE6
		7.0	1450946	NEBM-S1W15-E-7-Q7-LE6
		10	1450947	NEBM-S1W15-E-10-Q7-LE6
		15	610857	NEBM-S1W15-E-15-Q7-LE6
Encoder cable¹⁾				
	<ul style="list-style-type: none"> For stepper motor EMMS-ST-42/57/87-...-G2/G3 with CMMT-ST Straight plug 	2.5	1451587	NEBM-M12G8-E-2.5-LE8
		5	1451588	NEBM-M12G8-E-5-LE8
		7	1451589	NEBM-M12G8-E-7-LE8
		10	1451590	NEBM-M12G8-E-10-LE8
		15	611110	NEBM-M12G8-E-15-LE8
		20	611111	NEBM-M12G8-E-20-LE8
	<ul style="list-style-type: none"> For stepper motor EMMS-ST-42/57/87-...-G2 with CMMT-ST Angled plug 	2.5	1451675	NEBM-M12W8-E-2.5-LE8
		5	1451676	NEBM-M12W8-E-5-LE8
		7	1451677	NEBM-M12W8-E-7-LE8
		10	1451678	NEBM-M12W8-E-10-LE8
		15	610858	NEBM-M12W8-E-15-LE8

1) Cables especially suitable for the motor controller and motor.
Degree of protection to IP65 (in assembled state)

Possible cable and tube lengths



- Cables and tubing are selected so that the length specified when ordering will be the minimum connection length from the energy chain output.
- Cables and tubing are only available in fixed lengths as stated in the table below. This can mean that the cable plugs of the different cables do not end at the same point.

Length	1 m	2 m	5 m	7 m	10 m
Motor cable	–	■	■	■	■
Encoder cable	–	■	■	■	■
Multi-pin plug connecting cable	–	■	■	■	■
Tubing (for DHMZ only)	■	■	■	–	–

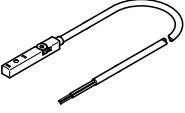

Ordering data – Accessories

Standard components within the handling system

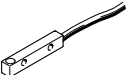
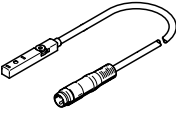

The handling system comprises a number of tried-and-tested standard components from Festo. Different components are used depending on the configuration. You can alter the scope and design of the accessories in the configurator HGO on the "System configuration" page.

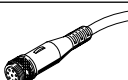
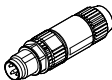
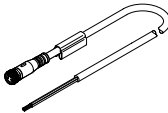
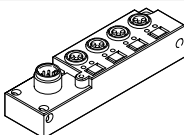
Designation	Description	Cable length [m]	Part no.	Type	
Proximity switch (inductive) for sensing the position of the slide on the X-/Y-/Z-axis					
	Cable with open end				
	<ul style="list-style-type: none"> For toothed belt axis EGC-TB, EGC-HD-TB For spindle axis EGC-BS For spindle axis ELGC-BS For DC voltage Included if the "Festo sensor package" is selected: <ul style="list-style-type: none"> For EGC, ELGC: 2 pieces 	PNP, N/C contact	7.5	551391	SIES-8M-PO-24V-K-7.5-OE
		PNP, N/O contact	7.5	551386	SIES-8M-PS-24V-K-7.5-OE
		NPN, N/C contact	7.5	551401	SIES-8M-NO-24V-K-7.5-OE
		NPN, N/O contact	7.5	551396	SIES-8M-NS-24V-K-7.5-OE
Proximity switches for sensing the position of the slide on the X-axis					
	<ul style="list-style-type: none"> For EXCM-40, EXCH-40, EXCH-60 PNP, N/O contact	–	150491	SIES-V3B-PS-S-L	
	<ul style="list-style-type: none"> For EXCM-40, EXCH-40, EXCH-60 PNP, N/C contact Included if the "Festo sensor package" is selected: <ul style="list-style-type: none"> 1 piece 	–	174552	SIES-Q8B-PO-K-L	
Proximity switch (inductive) for sensing the position of the slide on the Y-axis					
	Cable with plug				
	<ul style="list-style-type: none"> For EXCM-40, EXCH-40, EXCH-60 For DC voltage Included if the "Festo sensor package" is selected: <ul style="list-style-type: none"> 1 piece 	PNP, N/C contact	0.3	551392	SIES-8M-PO-24V-K-0.3-M8D
		PNP, N/O contact	0.3	551387	SIES-8M-PS-24V-K-0.3-M8D

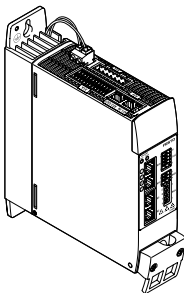
Ordering data – Accessories

Designation	Description	Cable length [m]	Part no.	Type
Plug socket with cable				
	• Connection between multi-pin plug distributor NEDU and control cabinet	5	525618	SIM-M12-8GD-5-PU
		10	570008	SIM-M12-8GD-10-PU
Plug				
	• For connection to the multi-pin plug distributor NEDU / distributor NEDY	–	562024	NECU-S-M8G3-HX
Connecting cable				
	• Connection between distributor NEDY and control cabinet	2.5	541342	NEBU-M8G4-K-2.5-LE4
		5	541343	NEBU-M8G4-K-5-LE4
		7.5	610854	NEBU-M8G4-K-7.5-LE4
		10	589560	NEBU-M8G4-K-10-LE4
		15	610855	NEBU-M8G4-K-15-LE4
Multi-pin plug distributor				
	• With the help of the multi-pin plug distributor, electrical signals such as for end-position sensing can be transferred collectively Options: – 4 individual connections – 6 individual connections	–	574586	NEDU-L4R1-M8G3L-M12G8
			574587	NEDU-L6R1-M8G3L-M12G8
	• With the help of the distributor, electrical signals such as for end-position sensing can be transferred collectively – 2 individual connections	–	8005312	NEDY-L2R1-V1-M8G3-N-M8G4
Motor controller/servo drive				
	The accessories for the relevant motor controllers/servo drives can be found at: • www.festo.com/catalogue/cmmt			

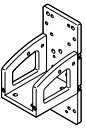
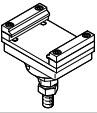
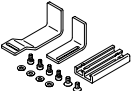
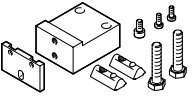
Ordering data – Accessories

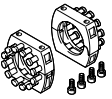
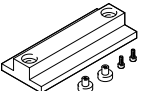
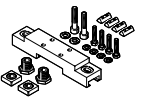
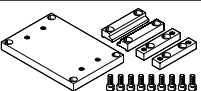
Designation	Description	Part no.	Type
Mounting kit			
	<ul style="list-style-type: none"> Mounting kit for the energy chain and a Z-axis, such as EGSL, DGSL 	<ul style="list-style-type: none"> EXCM-30 	<ul style="list-style-type: none"> 4070088 EAHT-E9-FB-3D-30
Adjusting kit			
	<ul style="list-style-type: none"> Height-adjustable mounting kit 	<ul style="list-style-type: none"> EXCM-30 	<ul style="list-style-type: none"> 4070088 EADC-E11-30
Sensor mounting			
	<ul style="list-style-type: none"> For homing in combination with third-party motors 	<ul style="list-style-type: none"> EXCM-30 	<ul style="list-style-type: none"> 4070088 EAPR-E11-30
Sensor mounting			
	<ul style="list-style-type: none"> For mounting the proximity switches SIES-Q8B, SIES-V3B on the X-axis 	<ul style="list-style-type: none"> EXCM-40, EXCH-40 EXCH-60 	<ul style="list-style-type: none"> 2536353 2478805 EAPR-E12-40 EAPR-E12-60
Energy chain			
	<ul style="list-style-type: none"> As a cable guide for the Z-axis 	<ul style="list-style-type: none"> EXCM-30 	<ul style="list-style-type: none"> 8059999 8060324 EADH-U-3D-30 EADH-U-3D-40
Connector set			
	<ul style="list-style-type: none"> Retaining brackets for mounting the energy chain 	<ul style="list-style-type: none"> EXCM-30 	<ul style="list-style-type: none"> 8060325 8060326 EAHT-AE-3D-30 EAHT-AE-3D-40
Adjusting tool			
	<ul style="list-style-type: none"> For aligning and checking the flatness of the planar surface gantry 	<ul style="list-style-type: none"> EXCM-40, EXCH-40, EXCH-60 	<ul style="list-style-type: none"> 3197697 EADT-W-E12
Adjusting kit			
	<ul style="list-style-type: none"> Used to mount the handling system on the supporting surface Can be used to easily compensate for any unevenness in the supporting surface 	<ul style="list-style-type: none"> EHMx-...-EGC-50-TB-KF EHMx-...-EGC-80-TB-KF EHMx-...-EGC-120-TB-KF EHMx-...-EGC-185-TB-KF EHMx-...-ELGC-60-BS EHMx-...-ELGC-80-BS 	<ul style="list-style-type: none"> 8047565 8047566 8047567 8047568 8142650 8142651 EADC-E15-50-E7 EADC-E15-80-E7 EADC-E15-120-E7 EADC-E15-185-E7 EADC-E15-60-E22 EADC-E15-80-E22
Profile mounting			
	<ul style="list-style-type: none"> Used to mount the handling system on the supporting surface It is not height-adjustable 	<ul style="list-style-type: none"> EHMx-...-ELGC-60-BS EHMx-...-ELGC-80-BS 	<ul style="list-style-type: none"> 8142652 8142653 EAHM-E15-60-E22 EAHM-E15-80-E22

Programming aid

Festo Automation Suite

Parameterisation and programming software for electronic devices from Festo

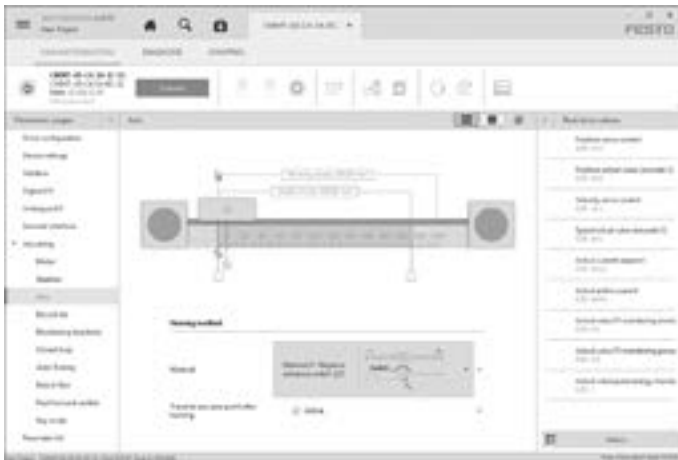

- Parameterisation, programming and commissioning in a clear and user-friendly interface
- Optimum support for complex processes thanks to guided wizards (e.g. for commissioning, drive configuration, etc.)
- Fast access to the required documents and additional information
- Easy integration of electric drives in the controller programming