

Proportional directional control valve VPWI

FESTO



Characteristics

At a glance

The VPWI is a directly actuated proportional pressure regulator that uses two proportional 2/2-way valves as a basis.

The valve regulates a valve stroke to an electronically preset value and thus enables a pneumatic flow rate to be adjusted proportionally.

Control is provided by an analogue current or voltage signal, or alternatively via a digital pattern for adjustable setpoint values, or using a PWM signal.

The characteristic curve of the stroke can be modified by the “curvature factor”, so that an application-specific flow curve can be achieved. Furthermore, the valve has a control mode which, with the help of the integrated pressure sensor, can keep the flow rate constant as the counter pressure increases.

Ordering data - modular system

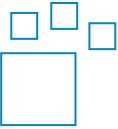

Configurable product

This product and all its product options can be ordered online via the configurator.

Valve function

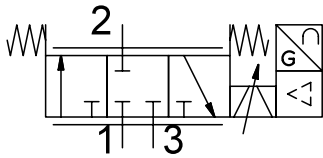

Type code

001	Series
VPWI	Proportional directional control valve VPWI
002	Nominal width [mm]
1.8	1.8
5	5
003	Directional control valve type
L	In-line valve
004	Valve function
3	3/3-way valve, normally closed
4	3/3-way valve, normally open
6	2/2-way valve, normally closed
7	2/2-way valve, normally open
005	Pneumatic connection
G18	G1/8

006	Pressure range [bar]
1	0 ... 1
6	0 ... 6
12	0 ... 12
B2	-1 ... 1
007	Setpoint input for individual valves
A2	0 ... 20 mA
A4	4 ... 20 mA
LK	IO-Link®
V1	0 ... 10 V
008	Operator unit/interface
BT	Bluetooth
D	Display
E1	LED-unit, 7 segments
L	LED
009	Certificate
	None
T	Test report

Datasheet

General technical data

Nominal size, supply	5 mm
Nominal size, exhaust	5 mm
Dimensions (W x L x H)	42.2 x 95.3 x 94.3 mm, 42.2 mm x 95.3 mm x 94.3 mm
Valve function	3-way proportional directional control valve
Type of reset	Mechanical spring
Design	Poppet valve with spring return
Sealing principle	Soft
Type of actuation	Electric
Type of piloting	Direct
Flow direction	Non-reversible
Total leakage	5 l/h
Mounting position	optional
Type of mounting	Via through-hole for M4 screw With H-rail
Pneumatic connection, port 1	G1/8
Pneumatic connection, port 2	G1/8
Product weight	370 g
Degree of protection	IP65
Safety instructions	Fail-safe position VPWI, normally closed
Instructions on use	The product is suitable for industrial purposes only. Measures to eliminate radio interference may be required in residential areas.

Operating and environmental conditions

Operating pressure	0 ... 1.3 MPa
Operating pressure	0 ... 13 bar
Inlet pressure 1	0 ... 1.3 MPa
Inlet pressure 1	0 ... 13 bar
Input pressure 3	-0.1 ... 0 MPa
Input pressure 3	-1 ... 0 bar
Burst pressure	4 MPa
Burst pressure	40 bar
Ambient temperature	0 ... 50°C
Media temperature	0 ... 50°C
Storage temperature	-20 ... 70°C
Vibration resistance	Transport application test with severity level 2 to FN 942017-4 and EN 60068-2-6
Shock resistance	Shock test with severity level 2 to FN 942017-5 and EN 60068-2-27
Sound power level	62.5 dB(A)
Sound power level at a distance of 1 m	51.9 dB(A)
Operating medium	Compressed air to ISO 8573-1:2010 [7:4:4], Inert gases
Note on operating and pilot medium	Lubricated operation not possible
Corrosion resistance class CRC ¹⁾	2 - Moderate corrosion stress
CE mark (see declaration of conformity) ²⁾	To EU EMC Directive In accordance with EU RoHS Directive
CE marking (see declaration of conformity) ³⁾	To UK instructions for EMC To UK RoHS instructions
Approval	RCM trademark, c UL us listed (OL)
Climatic category	3K3 as per EN 60721
Max. tightening torque for fitting	8.5 Nm

1) More information: www.festo.com/x/topic/crc

2) For information about the area of use, see the declaration of conformity at: www.festo.com/catalogue/...d/Support/Downloads.

If the devices are subject to usage restrictions in residential, commercial or light-industrial environments, further measures for the reduction of the emitted interference may be necessary.

3) For information about the area of use, see the declaration of conformity at: www.festo.com/catalogue/...d/Support/Downloads.

If the devices are subject to usage restrictions in residential, commercial or light-industrial environments, further measures for the reduction of the emitted interference may be necessary.

Datasheet

Electrical data		
Signal range analogue output	0 - 10 V	4 - 20 mA
Setpoint value input	0 - 10 V	4 - 20 mA
Input resistance	100 kOhm	0.3 kOhm
Switching output	Push-pull	–
Max. output current	25 mA	–
Min. load resistance voltage output	2 kOhm	–
Max. cable length	30 m	
Accuracy analogue output in ± %FS	1 %FS	
C value	2.1 l/sbar	
Limit frequency	125 Hz	
Switching time on	8 ms	
Switching time off	8 ms	
Nominal operating voltage DC	24 V	
Operational voltage range DC	21.6 ... 27.6 V	
Repetition accuracy FS	0.3%	
Electrical connection 1, connection type	Plugs	
Electrical connection 1, function	Actual value output Setpoint input Power supply	
Electrical connection 1, tightening torque	1.5 Nm	
Hysteresis	0.3 %FS	
Temperature coefficient	0.02 %/K	
Reverse polarity protection	For all electrical connections	
Short circuit current rating	For all electrical connections	

Materials	
LABS (PWIS) conformity	VDMA24364-B1/B2-L
Suitable for use with food	See supplementary material information
Note on materials	RoHS-compliant
Material cover	PA-reinforced
Material seals	HNBR PTFE
Material housing	PA-reinforced

Dimensions

Dimensions – Proportional directional control valve VPWI

Download CAD data www.festo.com

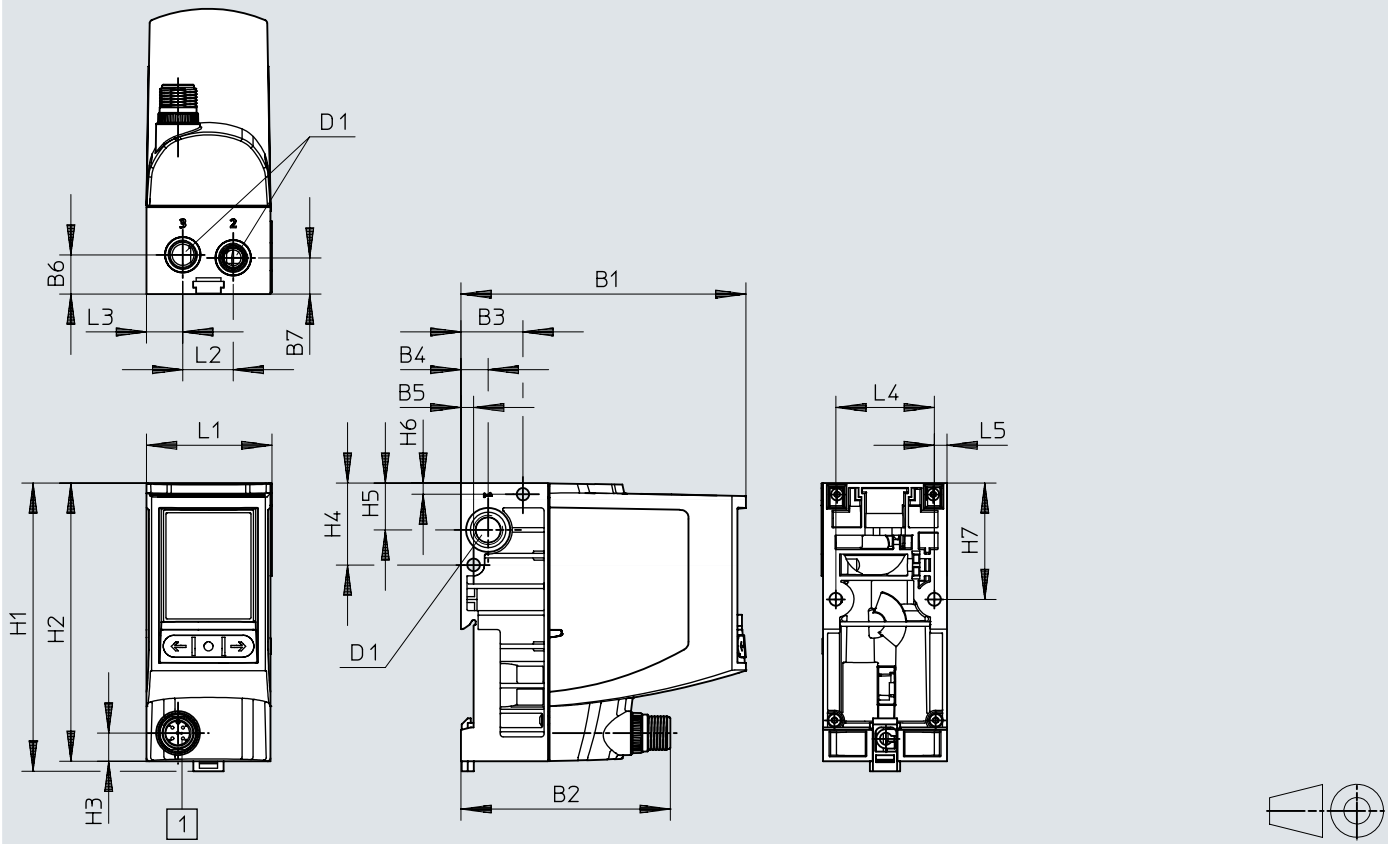

[1] M12x1, A-coded to EN 61076-2-101

	B1	B2	B3	B4	B5	B6	B7	D1
VPWI-5-L-3-G18-B2-V1-D	94,3	69,3	20,5	9	4,2	13	12	G1/8
VPWI-5-L-3-G18-B2-A4-D								
VPWI-5-L-3-G18-6-V1-D								
VPWI-5-L-3-G18-6-A4-D								
VPWI-5-L-3-G18-12-V1-D								
VPWI-5-L-3-G18-12-A4-D								

	H1	H2	H3	H4	H5	H6	H7	L1	L2	L3	L4	L5
VPWI-5-L-3-G18-B2-V1-D	95,3	92	9,3	27,1	15,5	3,7	38,5	41,5	16,7	12	32,6	4,2
VPWI-5-L-3-G18-B2-A4-D												
VPWI-5-L-3-G18-6-V1-D												
VPWI-5-L-3-G18-6-A4-D												
VPWI-5-L-3-G18-12-V1-D												
VPWI-5-L-3-G18-12-A4-D												

Ordering data

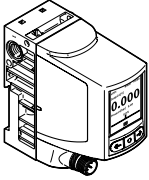
Proportional directional control valve VPWI					
	Valve function	Operating pressure	Operating pressure	Part no.	Type
	3-way proportional directional control valve	0 ... 0.2 MPa	0 ... 2 bar	8167809	VPWI-5-L-3-G18-B2-V1-D
				8167810	VPWI-5-L-3-G18-B2-A4-D
		0.6 ... 0.8 MPa	6 ... 8 bar	8167812	VPWI-5-L-3-G18-6-A4-D
				8167811	VPWI-5-L-3-G18-6-V1-D
		1.2 ... 1.3 MPa	12 ... 13 bar	8167814	VPWI-5-L-3-G18-12-A4-D
				8167813	VPWI-5-L-3-G18-12-V1-D

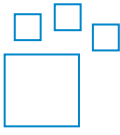
Configurable					
	Valve function	Operating pressure	Operating pressure	Part no.	Type
	3-way proportional directional control valve	0 ... 1.3 MPa	0 ... 13 bar	8167808	VPWI-

Peripherals

Peripherals overview

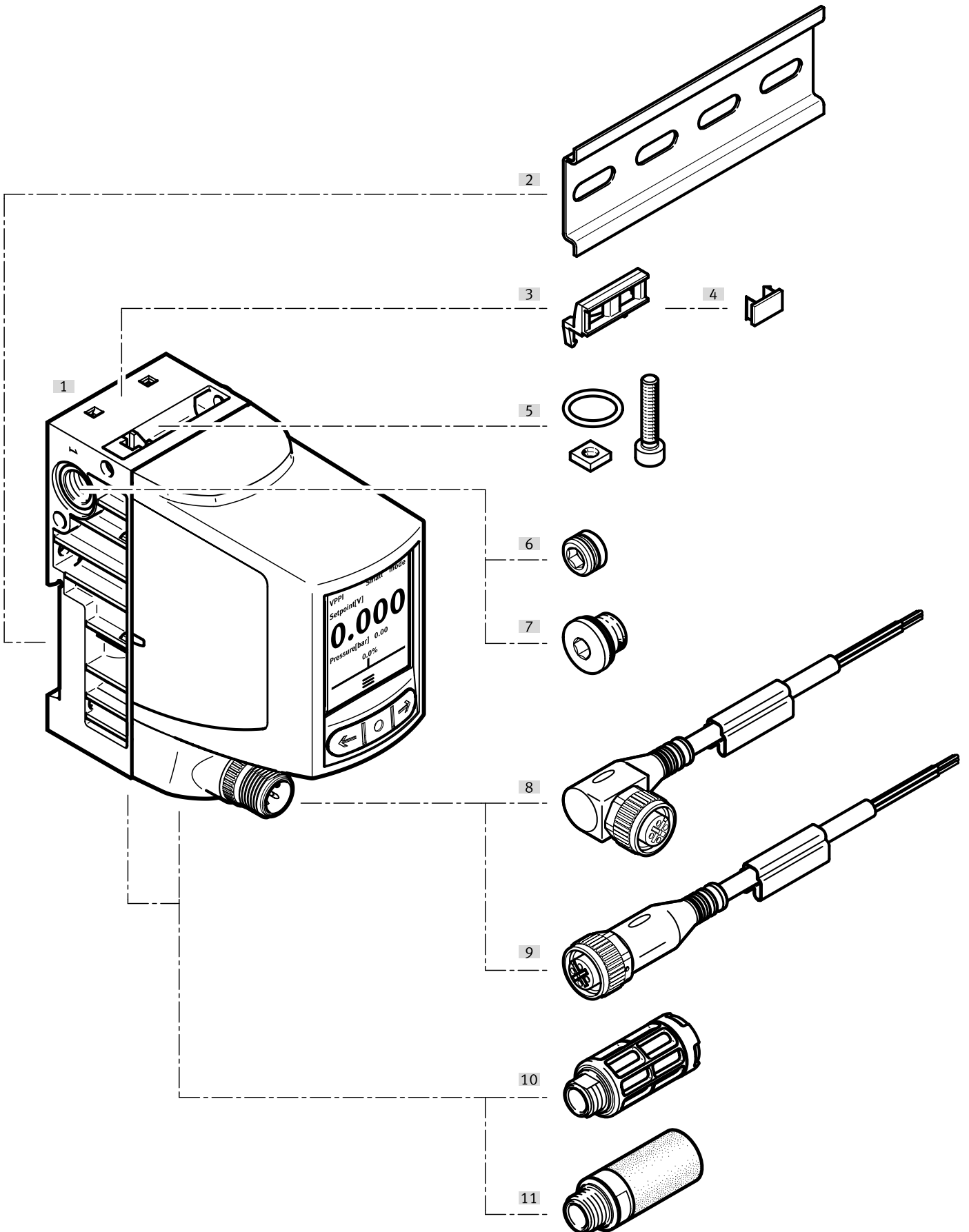

Peripherals

Accessories		→ Link
Type/order code	Description	
[1] Proportional directional control valve VPWI	Proportional directional control valve	vpwi
[2] H-rail	H-rail	11
[3] Inscription label holder	Inscription label holder	VMPAL
[4] Inscription labels	Inscription labels	10
[5] Interlinking set	Interlinking set	10
[6] Plug screw	Plug screw	10
[7] Blanking plug	Blanking plug	10
[8] Connecting cable, angled	Connecting cable, angled	10
[9] Connecting cable, straight	Connecting cable, straight	10
[10] Silencer	Silencer	11
[11] Flow control/silencers	Flow control/silencers	11

Accessories

Connecting cable, angled

	Electrical connection 1, connector system	Electrical connection 2, connector system	Cable structure	Cable length	Part no.	Type
	M12x1, A-coded to EN 61076-2-101	Open end	5 x 0.25 mm ²	2.5 m	567843	NEBU-M12W5-K-2.5-LE5
				5 m	567844	NEBU-M12W5-K-5-LE5

Connecting cable, straight

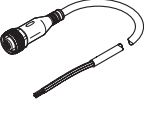
	Electrical connection 1, connector system	Electrical connection 2, connector system	Cable structure	Cable length	Part no.	Type
	M12x1, A-coded to EN 61076-2-101	Open end	5 x 0.25 mm ²	2.5 m	541330	NEBU-M12G5-K-2.5-LE5
				5 m	541331	NEBU-M12G5-K-5-LE5

Inscription label holder

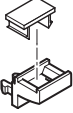
	Material label holder	Product weight	Size of pack	Part no.	Type
	POM	5 g	10	561115	VMPAL-ST-AP-20

Inscription labels

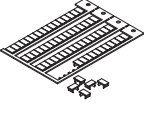
	Size	Labelling	Part no.	Type
	10x6 mm	64	18576	IBS-6X10

Interlinking set

	Size of pack	Part no.	Type
	5	8108270	VAME-P18-K-P5

Plug screws

	Material screws	Size	Size of pack	Part no.	Type
	Coated steel	G1/8	5	8108292	VAME-P18-BP-G18-P5
			10	8108271	VAME-P18-BP-G18-P10

Blanking plug

	Pneumatic connection, port 1	Product weight	Material blanking plug	Size of pack	Part no.	Type
	Male thread G1/8	7 g	Galvanised steel	10	★ 3568	B-1/8
				100	534213	B-1/8-100

Accessories

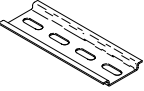
H-rail					
	LABS (PWIS) conformity	Part no.	Type		
	VDMA24364-B2-L	35430	NRH-35-2000		

Silencer					
	Pneumatic connection	Sound pressure level	Product weight	Part no.	Type
	G1/8	59 dB(A)	2.6 g	534219	UC-1/8-50
				★ 161419	UC-1/8
		74 dB(A)	2.3 g	★ 2307	U-1/8
				534222	U-1/8-50