

Solenoid valves MH2, MH3, MH4, fast-switching valves

FESTO



Key features

Fast-switching valves from Festo: it's not just the switching that's fast

Pros that switch as fast as 2 milliseconds

Speed, dynamic response and precision are more sought after than ever before in modern automation. The solution lies in pneumatic components. The result: shorter cycle times in return for comparatively low investment costs for the components. Maximum process reliability, sturdiness and service life are guaranteed.

High speed in production

The fast-switching valves are a technological treat for all things high-speed. With switching times ≤ 2 ms and a repetition accuracy ≤ 0.2 ms, they represent the pinnacle of what is technologically achievable worldwide – even in 24-hour continuous operation with over 500 million cycles.

Simple to retrofit in existing systems, or setting the pace for newly designed systems. Naturally compact, including maximum component density. Indispensable for sorting parts using an air ejector, in flap control systems, for gluing, dispensing, packaging and, of course, also suitable for pick & place vacuum applications, for example (continuous holding not possible).

Faster switching

Extremely short switching times enable short cycle times. Extremely precise switching makes it possible to control the timing of process sequences accurately. High output and very good machine utilisation are included. Excellent repetition accuracy of switching times ensures consistent processes, improves process and part quality and reduces rejects and rework.

Faster installation

With a variety of connection options such as thread or integrated push-in tubing connectors and a range of mounting options for individual valves or valve manifold assembly, the installation can be perfectly adapted to on-site circumstances while the footprint is kept to a minimum.

Fast-switching valves can be used directly in the application without additional protective measures. As a result, very short pneumatic lines guarantee short signal paths and fast response times.

Key features

Fast-switching valves from Festo: it's not just the switching that's fast



- Variants with and without fast-switching electronics as 3/2-way and 5/2-way valves
- Extremely short switching times with maximum repetition accuracy and outstanding service life
- Directly actuated poppet valve with degree of protection IP65

Advantages for designers



- Very high cycle rates
- Extremely short cycle times
- Maximum repetition accuracy
- Suitable for vacuum thanks to directly actuated poppet valve (time limited)
- Flexible design principle
- Direct activation via standard PLC possible
- Direct mounting in the application with IP65 protection

Advantages for purchasers



- Everything from a single source
- Low ordering costs
- No additional mounting components
- No costs for additional power outputs
- Use of standard PLCs
- Increased system productivity

Advantages for installation



- Easy installation
- Direct pneumatic connection via integrated tubing connections
- Reduced assembly costs with pre-assembled cables
- No additional protection required thanks to IP65

Key features

Fast and precise – sturdy and economical

High performance, process stability and extremely easy handling

Fast-switching valves MH increase switching frequencies and improve process and part quality with their excellent repetition accuracy.

Integrated: the fast-switching electronics

- All 3/2- and 5/2-way valves are available with built-in fast-switching electronics
- This enables constant dynamic response independent of temperature or supply voltage fluctuations
- With Festo plug & work, installation is easy, and no additional electronics or pneumatics know-how is necessary

Optimised: systems and processes

- On-site assembly thanks to IP65 – not sensitive to dust and humidity
- Direct activation with 24 V DC/1 A – use of PLC standard outputs
- With an extremely long service life of 500 million cycles, and continuous three-shift operation with no need for maintenance, optimum efficiency comes as standard!

Key features

- Repetition accuracy ≤ 0.2 ms for accurate dispensing/bonding, for example
- Switching time ≤ 3 ms for short cycle times and very quick response characteristics
- 10 mm width for compact assembly
- Choice of connections as an individual valve, semi in-line or sub-base variant, enabling need-optimised installation
- Degree of protection IP65 enables direct mounting in the application without additional safeguarding
- Easy installation via direct activation from the standard PLC with 24 V DC/1 A

Fast valves and an optimised control chain – two guarantees for success

To generate speed in pneumatics, the valve and cylinder must be perfectly matched. The correct combination can result in a 30% increase in efficiency. Cylinders with small diameters and short strokes need fast valves!

Length means losses – focus on tubing

In terms of pneumatic efficiency, short tubing is a key factor. Reducing the tubing length from 1 m to 0.5 m, for example, improves the max. possible flow rate by 20%. A tube length greater than 2 m results in losses of up to 50%. In this case it is recommended to use tubing of the next size up.

Small and nearby – the clever alternative

Short tubing with a small diameter is ideal for mounting valves close to the cylinder. The small and light fast-switching valves are suitable for direct mounting in the application, thanks also to their degree of protection IP65. By using them together with smaller and lighter fittings, the weight is reduced, too. This results in particular in an improvement in the efficiency of moving systems.

Small and fast – a good combination

The switching time plays a crucial role with small cylinder volumes, especially with short-stroke cylinders. In the adjacent example, the combination with a fast-switching valve is 30% faster. In concrete terms, this means that the cylinder controlled using the fast-switching valve is already in the end position before the cylinder with the universal valve even begins to move. This equates to a significant increase in both the efficiency and the economy of the system, especially when taking into account that the two valves have comparable space requirements and weight, and the fast-switching valve uses less air and lasts 10 times as long!

Product range overview

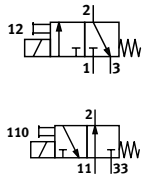
Function	Circuit symbol	Design	Switching time [ms]				Operating voltage [V DC]	→ Page/Internet
			Off ²⁾	On ²⁾	Off	On		
3/2-way valve¹⁾		Standard nominal flow rate 100 l/min						
		Individual valve	2	1.7	3.5	7	24	9
		Semi in-line valve	2	1.7	3.5	7	24	22
		Sub-base valve	2	1.7	3.5	7	24	40

- 1) Can be used as a 2/2-way valve by sealing port 3 or 33
- 2) With integrated fast-switching electronics

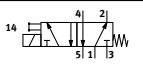
Function	Circuit symbol	Design	Switching time [ms]		Operating voltage [V DC]	→ Page/Internet	
			Off	On			
5/2-way valve		Standard nominal flow rate 100 l/min					
		Individual valve	1.7	1.9	24	16	
		Semi in-line valve	1.7	1.9	24	31	
		Sub-base valve	1.7	1.9	24	49	

Mounting options

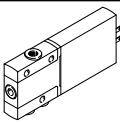
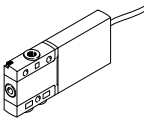
Design	Individual valve		Semi in-line valve		Sub-base valve	
Valve function	3/2-way	5/2-way	3/2-way	5/2-way	3/2-way	5/2-way
Plug vanes						
	Direct mounting	■	■	-	-	-
	Individual sub-base	-	-	■	■	■
	Manifold assembly	-	-	■	■	■
Moulded-in cable						
	Direct mounting	■	■	-	-	-
	Individual sub-base	-	-	-	-	■
	Manifold assembly	-	-	-	-	■

Product range overview

Function	Circuit symbol	Design	Switching time [ms]				Operating voltage [V DC]	→ Page/ Internet
			Off ²⁾	On ²⁾	Off	On		
3/2-way valve ¹⁾		Standard nominal flow rate 200 l/min						
		Individual valve	2.8	2.3	4.5	8.3	24	58
		Semi in-line valve	2.8	2.3	4.5	8.3	24	66
		Sub-base valve	2.8	2.3	4.5	8.3	24	75

- 1) Can be used as a 2/2-way valve by sealing port 3 or 33
- 2) With integrated fast-switching electronics

Mounting options				
Design		Individual valve	Semi in-line valve	Sub-base valve
Plug vanes				
	Direct mounting	■	-	-
	Individual sub-base	-	■	■
	Manifold assembly	-	■	■
Moulded-in cable				
	Direct mounting	■	-	-
	Individual sub-base	-	■	■
	Manifold assembly	-	■	■

Product range overview

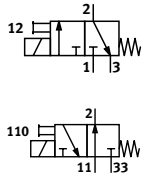
Function	Circuit symbol	Design	Switching time [ms]				Operating voltage [V DC]	→ Page/Internet
			Off ²⁾	On ²⁾	Off	On		
3/2-way valve ¹⁾	Standard nominal flow rate 400 l/min							
		Individual valve	3.5	3.5	5	10.5	24	85
		Semi in-line valve	3.5	3.5	5	10.5	24	91
		Sub-base valve	3.5	3.5	5	10.5	24	100

- 1) Can be used as a 2/2-way valve by sealing port 3 or 33
- 2) With integrated fast-switching electronics

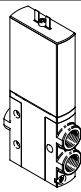
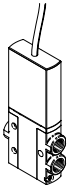
Mounting options		Individual valve	Semi in-line valve	Sub-base valve
Plug vanes				
	Direct mounting	■	–	–
	Individual sub-base	–	■	■
	Manifold assembly	–	■	■
Moulded-in cable				
	Direct mounting	■	–	–
	Individual sub-base	–	■	■
	Manifold assembly	–	■	■

Type codes

001	Series
MHA2	Solenoid valve MHA2
MHE2	Solenoid valve MHE2
MHP2	Solenoid valve MHP2
MHA3	Solenoid valve MHA3
MHE3	Solenoid valve MHE3
MHP3	Solenoid valve MHP3
MHA4	Solenoid valve MHA4
MHE4	Solenoid valve MHE4
MHP4	Solenoid valve MHP4

002	Drive system
M	Solenoid, switching

003	Nominal operating voltage
1	24 V DC

004	Manual override
H	Non-detenting

005	Valve function
3/2	3/2-way valve
5/2	5/2-way valve

006	Normal position
	5/2-way valve
G	Closed
O	Open

007	Pneumatic connection
2	Sub-base, nominal width 2 mm
3	Sub-base, nominal width 3 mm
4	Sub-base, nominal width 4 mm
1/8	Thread G1/8
1/4	Thread G1/4
M5	Thread M5
M7	Thread M7
QS-4	Push-in connector, 4 mm
QS-6	Push-in connector 6 mm
QS-8	Push-in connector 8 mm

008	Electrical connection
	Plug tabs
K	Moulded cable, 2.5 m long

Peripherals overview – Individual valve, 3/2-way valve

Connection with plug vanes – Connection with moulded-in cable

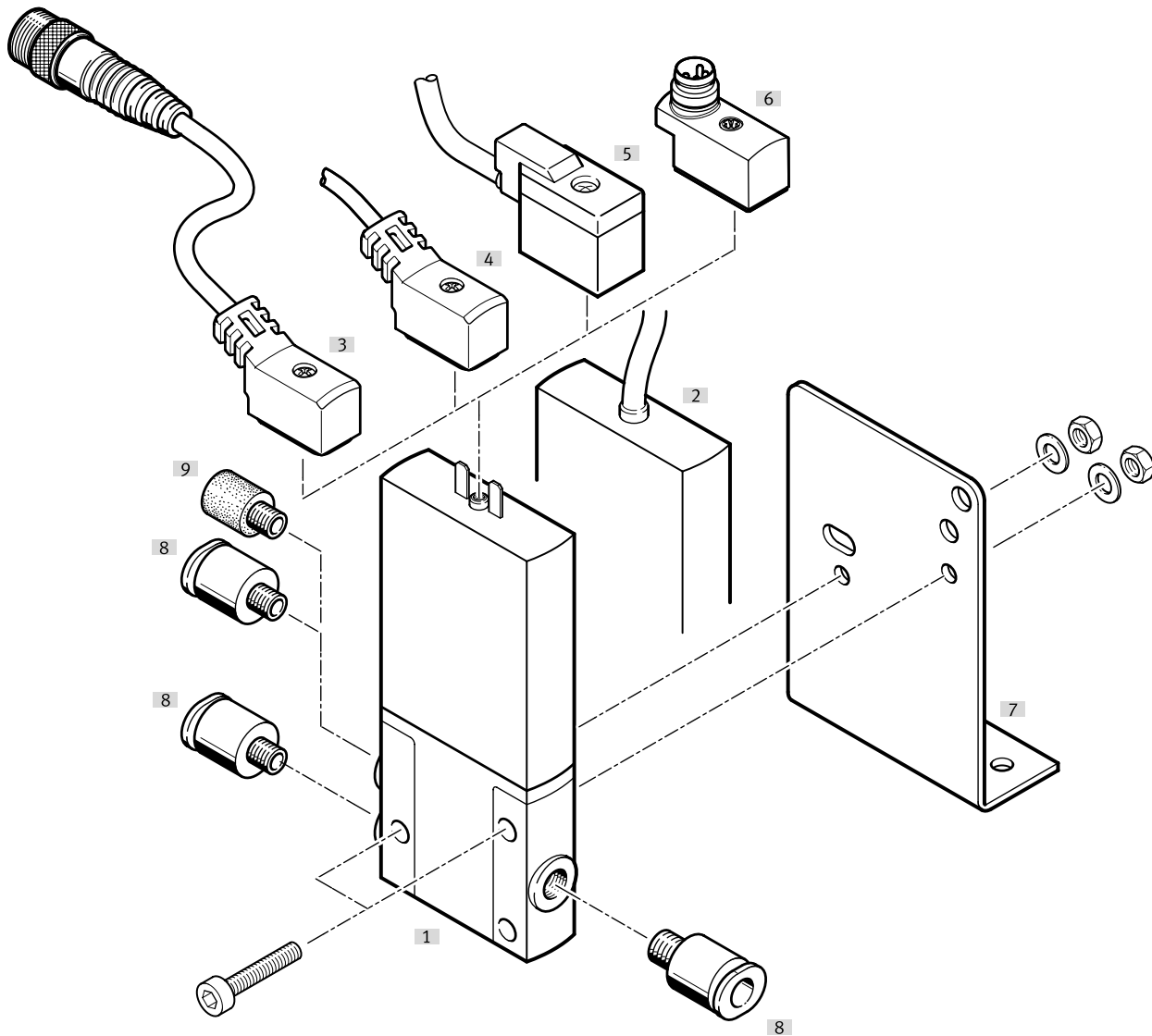

Designation	Type	Description	→ Page/Internet
[1] Individual valve	MHE2	With plug vanes	14
[2] Individual valve	MHE2-...-K	With moulded-in cable, IP55	14
[3] Connecting cable	NEBV	PUR cable, signal status indication with LED, plug M8x1 3-pin, IP65	15
[4] Connecting cable	NEBV	PUR cable, signal status indication with LED, IP65	15
[5] Plug socket with cable	KMYZ-4	PVC cable, without signal status indication, IP50	15
[6] Adapter	VAVE-C8	For connecting the valves via connecting cable M8 3-pin or 4-pin, IP65	15
[7] Mounting bracket	MHE2-BG-L	For wall mounting	15
[8] Push-in fittings	QS	For connecting compressed air tubing with standard O.D.	15
[9] Silencer	UC	For fitting in exhaust ports	15

Datasheet – Individual valve, 3/2-way valve

Function

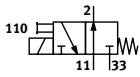
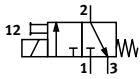

-  - Voltage
24 V DC

-  - Pressure
-0.09 ... +0.8 MPa

-  - Temperature range
-5 ... +60°C

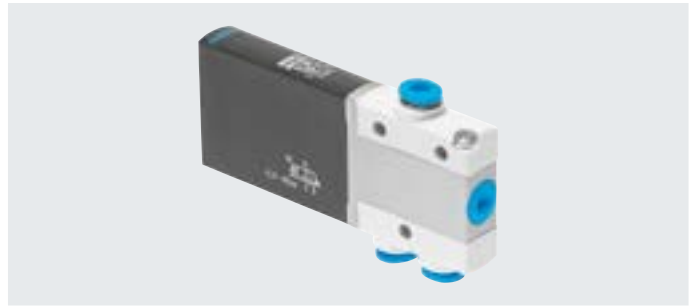

General technical data

Valve function	3/2 way, single solenoid ¹⁾
Design	Pressure relief poppet valve
Overlap	Negative overlap
Sealing principle	Soft
Reset method	Mechanical spring
Actuation type	Electrical
Type of control	Direct
Direction of flow	Reversible with restrictions ²⁾
Exhaust function	Can be throttled
Manual override	Non-detenting
Mounting position	Any
Width	[mm] 10
Grid dimension	[mm] 14
Note on grid dimension	Minimum distance between the valves is 4 mm
Nominal width	[mm] 2
Standard nominal flow rate	[l/min] 100
Type of mounting	Via through-hole
Pneumatic connection	M7 connecting thread Push-in connector for tubing O.D. 4 mm
Product weight	[g] 60

1) Can be used as a 2/2-way valve by sealing port 3 or 33

2) Slight leakage can occur in the pressure range -0.8 bar to +0.5 bar.

Datasheet – Individual valve, 3/2-way valve

Operating and environmental conditions		With fast-switching electronics	Without fast-switching electronics	
Operating medium		Compressed air to ISO 8573-1:2010 [7:4:4]		
Note on the operating/pilot medium		Lubricated operation possible (in which case lubricated operation will always be required)		
Operating pressure	[MPa]	-0.09 ... +0.8		
	[bar]	-0.9 ... +8		
	Reversible	[MPa]	-0.09 ... +0.1	
		[bar]	-0.9 ... +1	
	[psi]	-13.05 ... +14.5		
Ambient temperature		[°C] -5 ... +60		
Temperature of medium		[°C] -5 ... +60		
Restricted ambient temperature and temperature of medium		As a function of switching frequency (see graph)	-	
Corrosion resistance class CRC ¹⁾		2	2	
CE marking (see declaration of conformity) ³⁾		To EU EMC Directive ²⁾	-	
		To EU RoHS Directive	-	
UKCA marking (see declaration of conformity) ³⁾		To UK instructions for EMC	-	
		To UK RoHS instructions	-	
Certification		c UL us - Recognized (OL)	c UL us - Recognized (OL)	
		RCM	-	
Cleanroom class		Class 6 to ISO 14644-1		
Shock resistance		Shock test with severity level 2 to FN 942017-5 and EN 60068-2-27		
Vibration resistance		Transport application test with severity level 2 to FN 942017-4 and EN 60068-2-6		

1) More information: www.festo.com/x/topic/kbk

2) For information about the area of use, see the EC declaration of conformity at: www.festo.com/catalogue/mh2 → Support/Downloads.

If the devices are subject to usage restrictions in residential, commercial or light-industrial environments, further measures for the reduction of the emitted interference may be necessary.

3) More information: www.festo.com/catalogue/... → Support/Downloads.

Electrical data		With fast-switching electronics	Without fast-switching electronics
Electrical connection		2-pin plug or cable	
Operating voltage	[V DC]	24	
Permissible voltage fluctuations		±10%	
Power consumption	[W]	5 for approx. 3 ms (high-current phase, inrush current 1 A)	2.88
	[W]	1.25 (low-current phase)	-
Reverse polarity protection		Bipolar	-
Duty cycle	[%]	100	100
Additional functions		Spark arresting	-
		Holding current reduction	-
		Protective circuit	-
Degree of protection to EN 60529	Electrical connection: 2-pin plug	IP65	IP65
	Electrical connection: cable	IP55	IP55

Switching times and frequencies		With fast-switching electronics	Without fast-switching electronics
Switching time	On [ms]	1.7	7
	Off [ms]	2	3.5
Tolerance for switching time	On [%]	+10 ... -30	-
	Off [%]	+10 ... -30	-
Switching time variation from 1 Hz upwards		[ms] 0.2	-
Maximum switching frequency		[Hz] 330	130

Materials	
Housing	Coated die-cast zinc
Cable sheath	PUR
Seals	HNBR, NBR
Screws	Galvanised steel
Note on materials	RoHS-compliant
PWIS conformity	VDMA24364-B1/B2-L

Datasheet – Individual valve, 3/2-way valve

Restricted ambient temperature and temperature of medium as a function of switching frequency

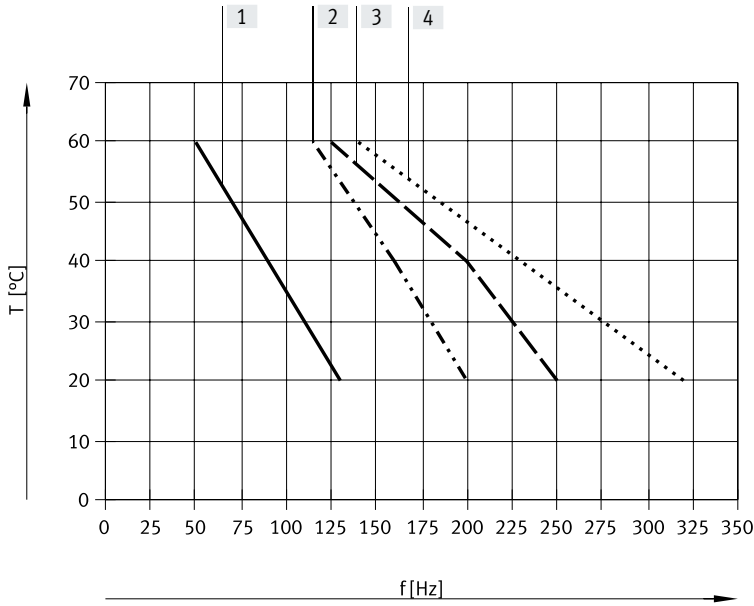

- [1] Valve manifold assembly, 6 valves, unpressurised
- [2] Valve manifold assembly, 6 valves, through-flow, 0.6 MPa
- [3] Individual valve, unpressurised
- [4] Individual valve, through-flow, 0.6 MPa

Current curve for valves with fast-switching electronics (MHE2-MS1H)

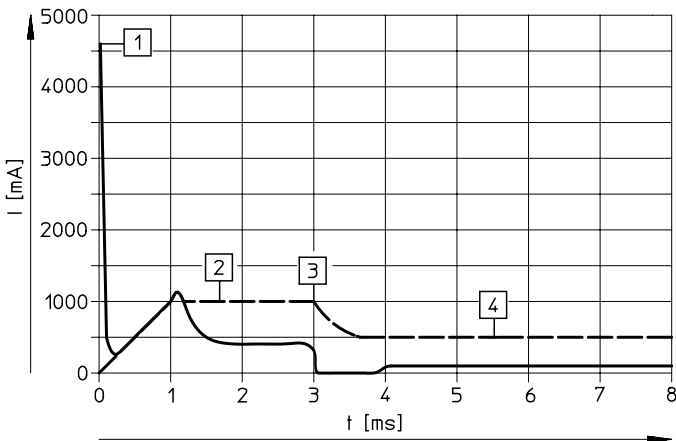

- [1] Capacitor charging
- [2] Controlled coil current 1 A
- [3] Holding current reduction
- [4] Controlled holding current 0.5 A

..... Internal current in the coil
 — External current in the supply line

Datasheet – Individual valve, 3/2-way valve

Dimensions

Download CAD data → www.festo.com

Valve with plug vanes or moulded-in cable

MHE2-...-3/0...-M7

MHE2-...-3/0...-QS-4

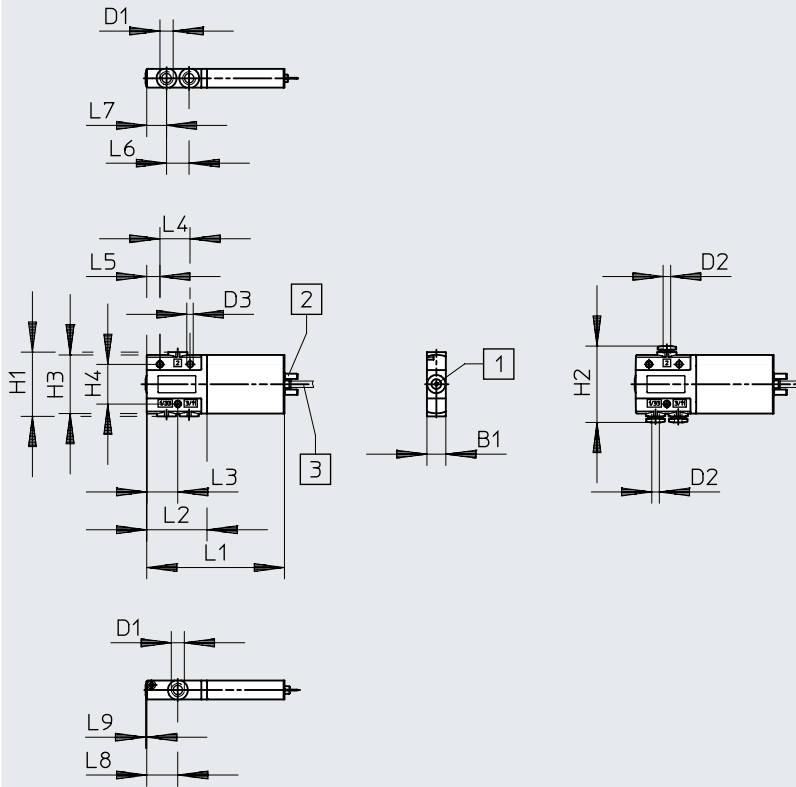

[1] Manual override, non-detenting

[2] Plug vanes

[3] Cable, 2.5 m

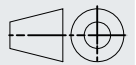

Mounting bracket MHE2-BG-L

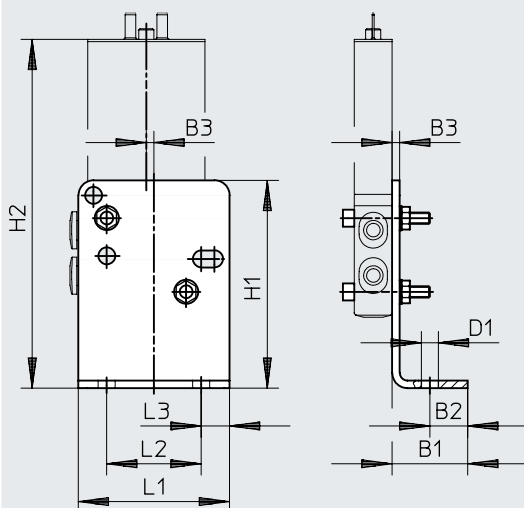



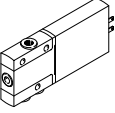
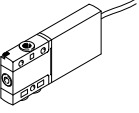

Type	B1	B2	B3	D1	D2 ∅	D3 ∅	H1	H2	H3	H4	L1	L2	L3	L4	L5	L6	L7	L8	L9
MHE2-...-3/0...-M7	10	-	-	M7	-	3.4	34	-	31	21	73	32	16.5	16	7	12	10.5	16.5	0.5
MHE2-...-3/0...-QS-4	10	-	-	-	4	3.4	34	40.4	31	21	73	32	16.5	16	7	12	10.5	16.5	0.5
MHE2-BG-L	20	10	2	4.5	-	-	55	92.3	-	-	40	25	7.5	-	-	-	-	-	-

Datasheet – Individual valve, 3/2-way valve

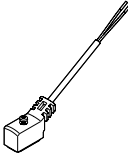
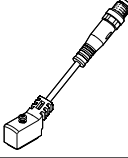
Ordering data					Part no.	Type	
Valves							
	Electrical connection: 2-pin plug	With fast-switching electronics, switching time 2 ms	Pneumatic connection: thread M7	Normally open	196151	MHE2-MS1H-3/2O-M7	
					Normally closed	196131	MHE2-MS1H-3/2G-M7
			Pneumatic connection: push-in connector for tubing O.D. 4 mm	Normally open	196155	MHE2-MS1H-3/2O-QS-4	
				Normally closed	196135	MHE2-MS1H-3/2G-QS-4	
		Without fast-switching electronics, switching time 7 ms	Pneumatic connection: thread M7	Normally open	196150	MHE2-M1H-3/2O-M7	
				Normally closed	196130	MHE2-M1H-3/2G-M7	
	Electrical connection: cable	With fast-switching electronics, switching time 2 ms	Pneumatic connection: thread M7	Normally open	196153	MHE2-MS1H-3/2O-M7-K	
					Normally closed	196133	MHE2-MS1H-3/2G-M7-K
			Pneumatic connection: push-in connector for tubing O.D. 4 mm	Normally open	196157	MHE2-MS1H-3/2O-QS-4-K	
				Normally closed	196137	MHE2-MS1H-3/2G-QS-4-K	
		Without fast-switching electronics, switching time 7 ms	Pneumatic connection: thread M7	Normally open	196152	MHE2-M1H-3/2O-M7-K	
				Normally closed	196132	MHE2-M1H-3/2G-M7-K	
	Pneumatic connection: push-in connector for tubing O.D. 4 mm	Normally open	196156	MHE2-M1H-3/2O-QS-4-K			
		Normally closed	196136	MHE2-M1H-3/2G-QS-4-K			

Datasheet – Individual valve, 3/2-way valve

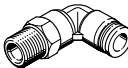
Ordering data					Part no.	Type
Connecting cable (for valves with 2-pin plug)					Datasheets → Internet: nebv	
	2-pin socket, open cable end 2-wire	PUR cable, degree of protection IP65	Signal status indication with LED	Length 2.5 m	8047671	NEBV-Z4WA2L-P-E-2.5-N-LE2-S1
				Length 5 m	8047672	NEBV-Z4WA2L-P-E-5-N-LE2-S1
				Length 10 m	8047670	NEBV-Z4WA2L-P-E-10-N-LE2-S1
		PVC cable, degree of protection IP40	Without signal status indication	Length 0.5 m	193690	KMYZ-4-24-0.5-B
Length 2.5 m	193691			KMYZ-4-24-2.5-B		
	2-pin socket, plug M8x1 3-pin	PUR cable, degree of protection IP65	Signal status indication with LED	Length 0.5 m	8047673	NEBV-Z4WA2L-P-E-0.5-N-M8G3-S1
				Length 2.5 m	8047674	NEBV-Z4WA2L-P-E-2.5-N-M8G3-S1
Adapter (for valves with 2-pin plug)						
	2-pin socket	Signal status indication with LED	Plug M8, 3-pin		571686	VAVE-C8-1R8
				Plug M8, 4-pin	573194	VAVE-C8-1R1
Wall mounting						
	Mounting bracket				196165	MHE2-BG-L
Silencer						
Datasheets → Internet: uc						
	Push-in sleeve with O.D. 4 mm			1 piece	165006	UC-QS-4H
	With M7 threaded connection			1 piece	161418	UC-M7
				50 pieces	534218	UC-M7-50
Push-in fitting						
Datasheets → Internet: qs						
	Male thread M7 with internal hex for tubing O.D.	4 mm		10 pieces	153319	QSM-M7-4-I
				100 pieces	133006	QSM-M7-4-I-100
		6 mm		10 pieces	153321	QSM-M7-6-I
				100 pieces	130773	QSM-M7-6-I-100
	Male thread M7 with external hex, push-in L-fitting rotatable through 360°, for tubing O.D.	4 mm		10 pieces	186352	QSML-M7-4
				100 pieces	130773	QSML-M7-4-100
		6 mm		10 pieces	186353	QSML-M7-6
				100 pieces	130774	QSML-M7-6-100

Peripherals overview – Individual valve, 5/2-way valve

Connection with plug vanes – Connection with moulded-in cable

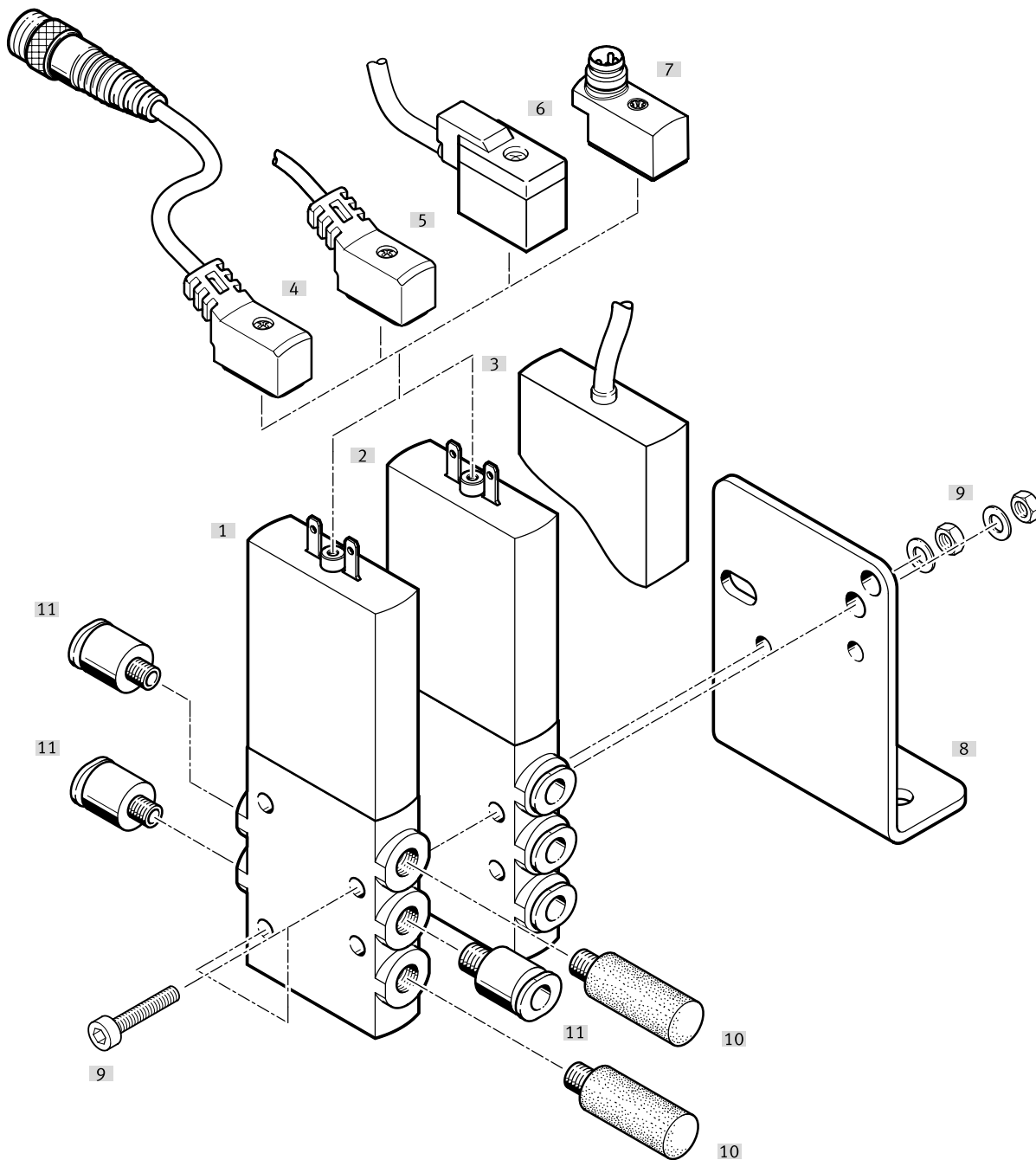



Designation	Type	Description	→ Page/Internet
[1] Individual valve	MHE2-...-M7	With plug vanes and connection M7	21
[2] Individual valve	MHE2-...QS-4	With plug vanes and push-in connector for standard O.D. tubing	21
[3] Individual valve	MHE2-...-K	With moulded-in cable, IP55	21
[4] Connecting cable	NEBV	PUR cable, signal status indication with LED, plug M8x1 3-pin, IP65	21
[5] Connecting cable	NEBV	PUR cable, signal status indication with LED, IP65	21
[6] Plug socket with cable	KMYZ-4	PVC cable, without signal status indication, IP50	21
[7] Adapter	VAVE-C8	For connecting the valves via connecting cable M8 3-pin or 4-pin, IP65	21
[8] Mounting bracket	MHE2-BG-L	For wall mounting	21
[9] Retaining screws	-	Hole diameter see dimensional drawing	-
[10] Silencer	UC	For fitting in exhaust ports	21
[11] Push-in fittings	QS	For connecting compressed air tubing with standard O.D.	21

Datasheet – Individual valve, 5/2-way valve

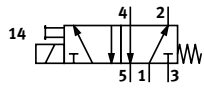
Function



-  - Voltage
24 V DC
-  - Pressure
-0.09 ... +0.8 MPa
-  - Temperature range
-5 ... +60°C



General technical data

Valve function		5/2-way, single solenoid
Design		Pressure relief poppet valve
Overlap		Negative overlap
Sealing principle		Soft
Reset method		Mechanical spring
Actuation type		Electrical
Type of control		Direct
Direction of flow		Not reversible
Exhaust function		Can be throttled
Manual override		Non-detenting
Mounting position		Any
Width	[mm]	10
Grid dimension	[mm]	14
Note on grid dimension		Minimum distance between the valves is 4 mm
Nominal width	[mm]	2
Standard nominal flow rate	[l/min]	90
Type of mounting		Via through-hole
Pneumatic connection		M7 connecting thread Push-in connector for tubing O.D. 4 mm
Max. tightening torque of fitting	[Nm]	2
Product weight	[g]	70

Datasheet – Individual valve, 5/2-way valve

Operating and environmental conditions		
Operating medium	Compressed air to ISO 8573-1:2010 [7:4:4]	
Note on the operating/pilot medium	Lubricated operation possible (in which case lubricated operation will always be required)	
Operating pressure	[MPa]	-0.09 ... +0.8
	[bar]	-0.9 ... +8
Ambient temperature	[°C]	-5 ... +60
Temperature of medium	[°C]	-5 ... +60
Restricted ambient temperature and temperature of medium	As a function of switching frequency (see graph)	
Corrosion resistance class CRC ¹⁾	2	
CE marking (see declaration of conformity) ³⁾	To EU EMC Directive ²⁾	
	To EU RoHS Directive	
UKCA marking (see declaration of conformity) ³⁾	To UK instructions for EMC	
	To UK RoHS instructions	
Certification	c UL us - Recognized (OL)	
	RCM	
Cleanroom class	Class 6 to ISO 14644-1	
Shock resistance	Shock test with severity level 2 to FN 942017-5 and EN 60068-2-27	
Vibration resistance	Transport application test with severity level 2 to FN 942017-4 and EN 60068-2-6	

1) More information: www.festo.com/x/topic/kbk

2) For information about the area of use, see the EC declaration of conformity at: www.festo.com/catalogue/mh2 → Support/Downloads.

If the devices are subject to usage restrictions in residential, commercial or light-industrial environments, further measures for the reduction of the emitted interference may be necessary.

3) More information: www.festo.com/catalogue/... → Support/Downloads.

Electrical data		2-pin plug	Cable
Electrical connection			
Operating voltage	[V DC]	24	
Permissible voltage fluctuations	[%]	±10	
Power consumption	Low-current phase	[W]	1.625
	High-current phase	[W]	6.5
Reverse polarity protection		Bipolar	
Duty cycle	[%]	100	
Additional functions		Spark arresting	
		Holding current reduction	
		Protective circuit	
Degree of protection to EN 60529		IP65	IP55

Switching times and frequencies			
Switching time	On	[ms]	1.9
	Off	[ms]	1.7
Tolerance for switching time	On	[%]	+10 ... -30
	Off	[%]	+10 ... -30
Switching time variation from 1 Hz upwards		[ms]	0.2
Maximum switching frequency		[Hz]	300

Materials	
Housing	Coated die-cast zinc
Cable sheath	PUR
Seals	HNBR, NBR
Screws	Galvanised steel
Note on materials	RoHS-compliant
PWIS conformity	VDMA24364-B1/B2-L

Datasheet – Individual valve, 5/2-way valve

Restricted ambient temperature and temperature of medium as a function of switching frequency

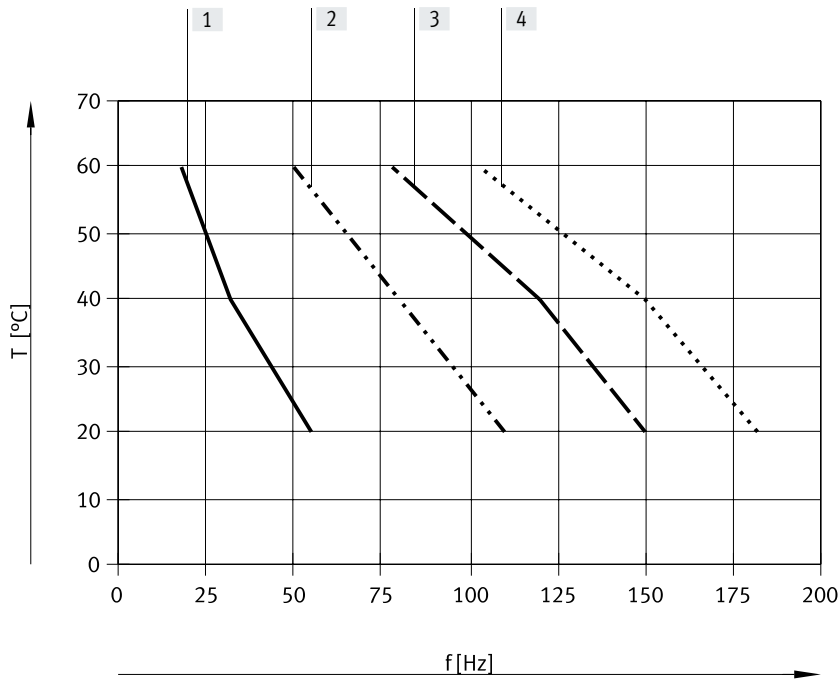

- [1] Valve manifold assembly, 6 valves, unpressurised
- [2] Valve manifold assembly, 6 valves, through-flow, 0.6 MPa
- [3] Individual valve, unpressurised
- [4] Individual valve, through-flow, 0.6 MPa

Current curve for valves with fast-switching electronics (MHE2-MS1H)

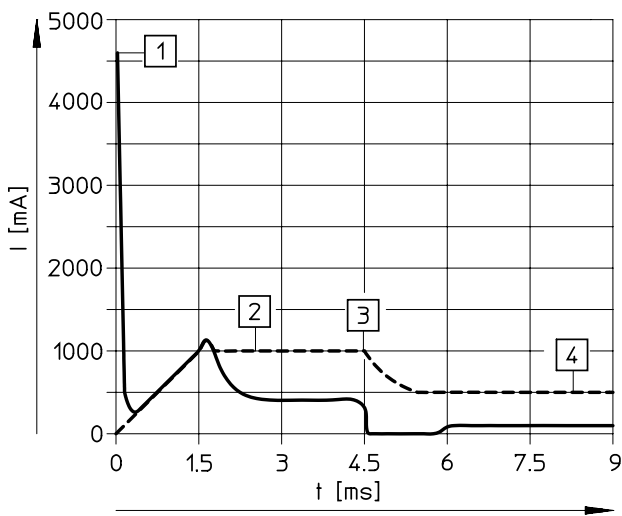

- [1] Capacitor charging
- [2] Controlled coil current 1 A
- [3] Holding current reduction
- [4] Controlled holding current 0.5 A

..... Internal current in the coil
 — External current in the supply line

Datasheet – Individual valve, 5/2-way valve

Dimensions

Download CAD data → www.festo.com

Valve with plug vanes or moulded-in cable

MHE2-...-5/2-M7

MHE2-...-5/2-QS-4

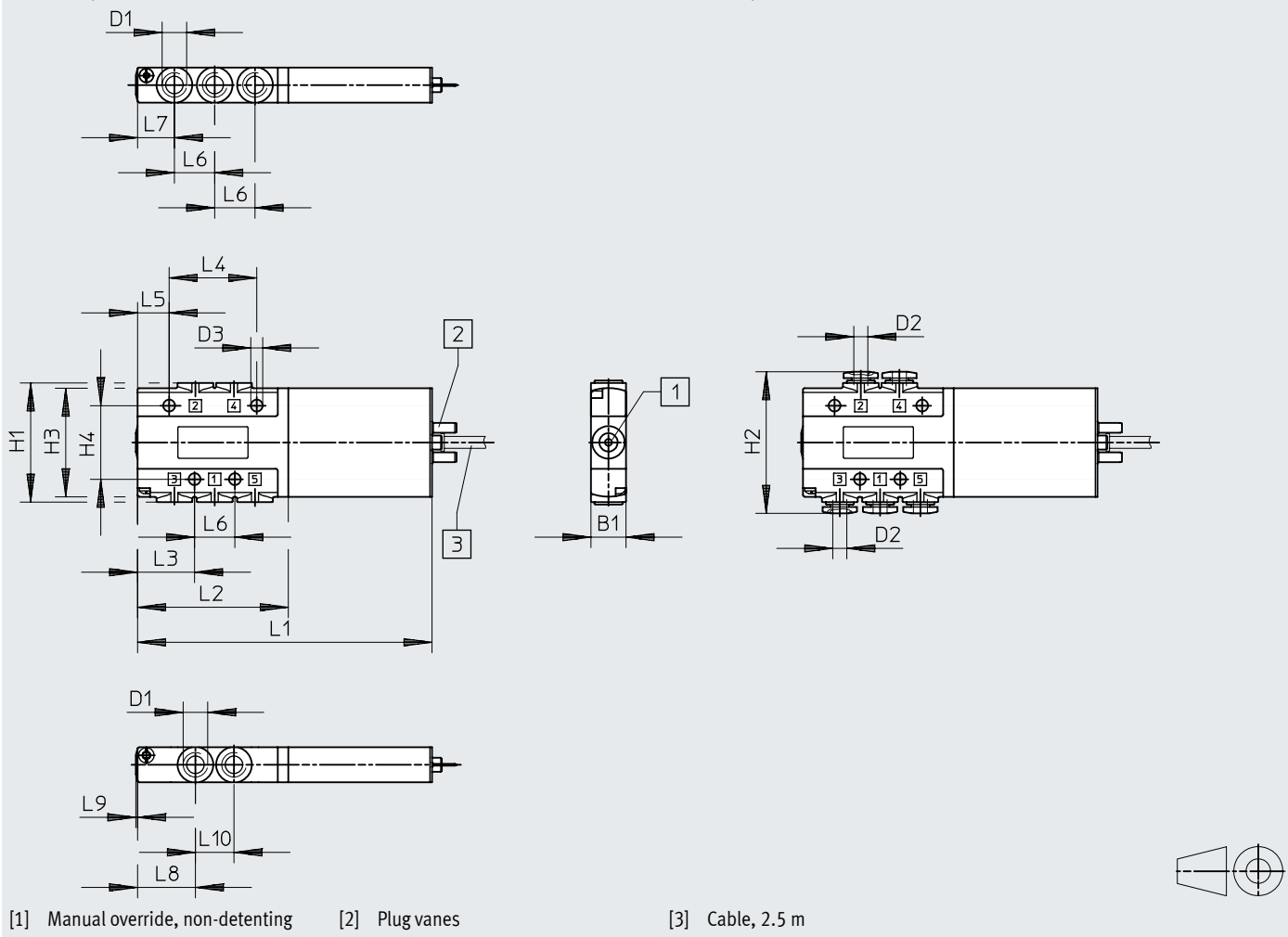



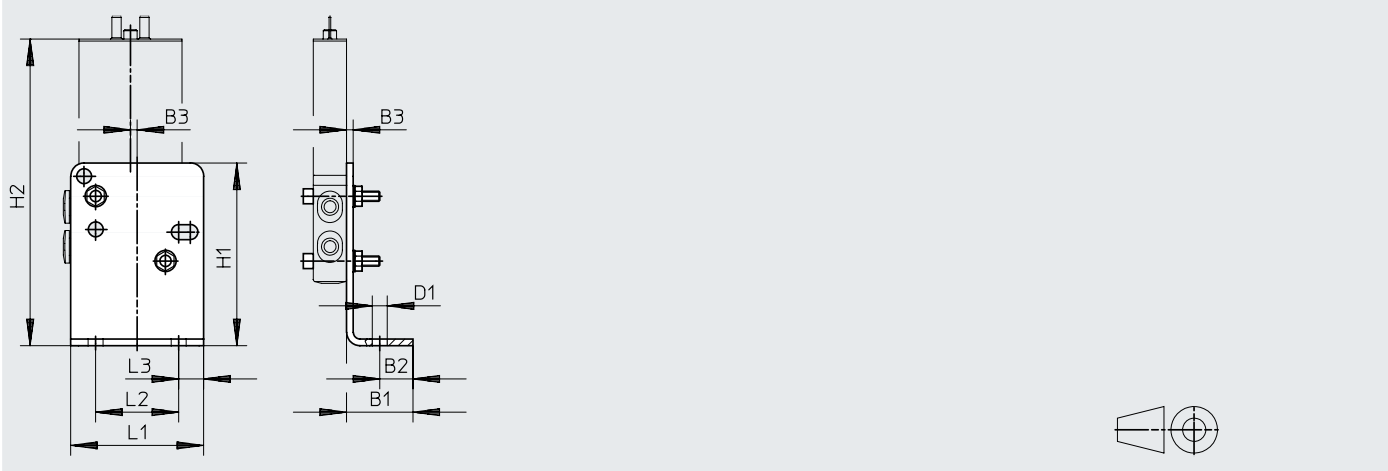

Mounting bracket MHE2-BG-L

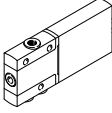
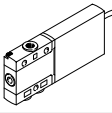
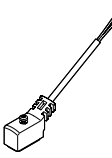
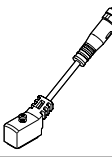
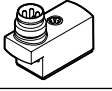

Type	B1	B2	B3	D1	D2 ∅	D3 ∅	H1	H2	H3	H4	L1	L2	L3	L4	L5	L6	L7	L8	L9	L10
MHE2-...-5/2-M7	10	-	-	M7	-	3.4	34	-	31	21	84	43	16.3	25	9	11.5	10.5	16.5	0.5	11
MHE2-...-5/2-QS-4	10	-	-	-	4	3.4	34	40.4	31	21	84	43	16.3	25	9	11.5	10.5	16.5	0.5	11
MHE2-BG-L	20	10	2	4.5	-	-	55	92.3	-	-	40	25	7.5	-	-	-	-	-	-	-

Datasheet – Individual valve, 5/2-way valve

Ordering data				Part no.	Type	
Valves						
	Electrical connection: 2-pin plug	With fast-switching electronics, switching time 2 ms	Pneumatic connection: thread M7	525113	MHE2-MS1H-5/2-M7	
			Pneumatic connection: push-in connector for tubing O.D. 4 mm	525117	MHE2-MS1H-5/2-QS-4	
	Electrical connection: cable	With fast-switching electronics, switching time 2 ms	Pneumatic connection: thread M7	525115	MHE2-MS1H-5/2-M7-K	
			Pneumatic connection: push-in connector for tubing O.D. 4 mm	525119	MHE2-MS1H-5/2-QS-4-K	
Connecting cable (for valves with 2-pin plug) Datasheets → Internet: nebv						
	2-pin socket, open cable end 2-wire	PUR cable, degree of protection IP65	Signal status indication with LED	Length 2.5 m	8047671	NEBV-Z4WA2L-P-E-2.5-N-LE2-S1
				Length 5 m	8047672	NEBV-Z4WA2L-P-E-5-N-LE2-S1
		PVC cable, degree of protection IP40	Without signal status indication	Length 10 m	8047670	NEBV-Z4WA2L-P-E-10-N-LE2-S1
				Length 0.5 m	193690	KMYZ-4-24-0.5-B
			Length 2.5 m	193691	KMYZ-4-24-2.5-B	
	2-pin socket, plug M8x1 3-pin	PUR cable, degree of protection IP65	Signal status indication with LED	Length 0.5 m	8047673	NEBV-Z4WA2L-P-E-0.5-N-M8G3-S1
				Length 2.5 m	8047674	NEBV-Z4WA2L-P-E-2.5-N-M8G3-S1
Adapter (for valves with 2-pin plug)						
	2-pin socket	Signal status indication with LED	Plug M8, 3-pin	571686	VAVE-C8-1R8	
			Plug M8, 4-pin	573194	VAVE-C8-1R1	
Wall mounting						
	Mounting bracket			196165	MHE2-BG-L	
Silencer Datasheets → Internet: uc						
	Push-in sleeve with O.D. 4 mm		1 piece	165006	UC-QS-4H	
	With M7 threaded connection		1 piece	161418	UC-M7	
			50 pieces	534218	UC-M7-50	
Push-in fitting Datasheets → Internet: qs						
	Male thread M7 with internal hex for tubing O.D.	4 mm	10 pieces	153319	QSM-M7-4-I	
			100 pieces	133006	QSM-M7-4-I-100	
		6 mm	10 pieces	153321	QSM-M7-6-I	
	Male thread M7 with external hex, push-in L-fitting rotatable through 360°, for tubing O.D.	4 mm	10 pieces	186352	QSML-M7-4	
			100 pieces	130773	QSML-M7-4-100	
		6 mm	10 pieces	186353	QSML-M7-6	
			100 pieces	130774	QSML-M7-6-100	

Peripherals overview – Semi in-line valve, 3/2-way valve

Connection via plug vanes

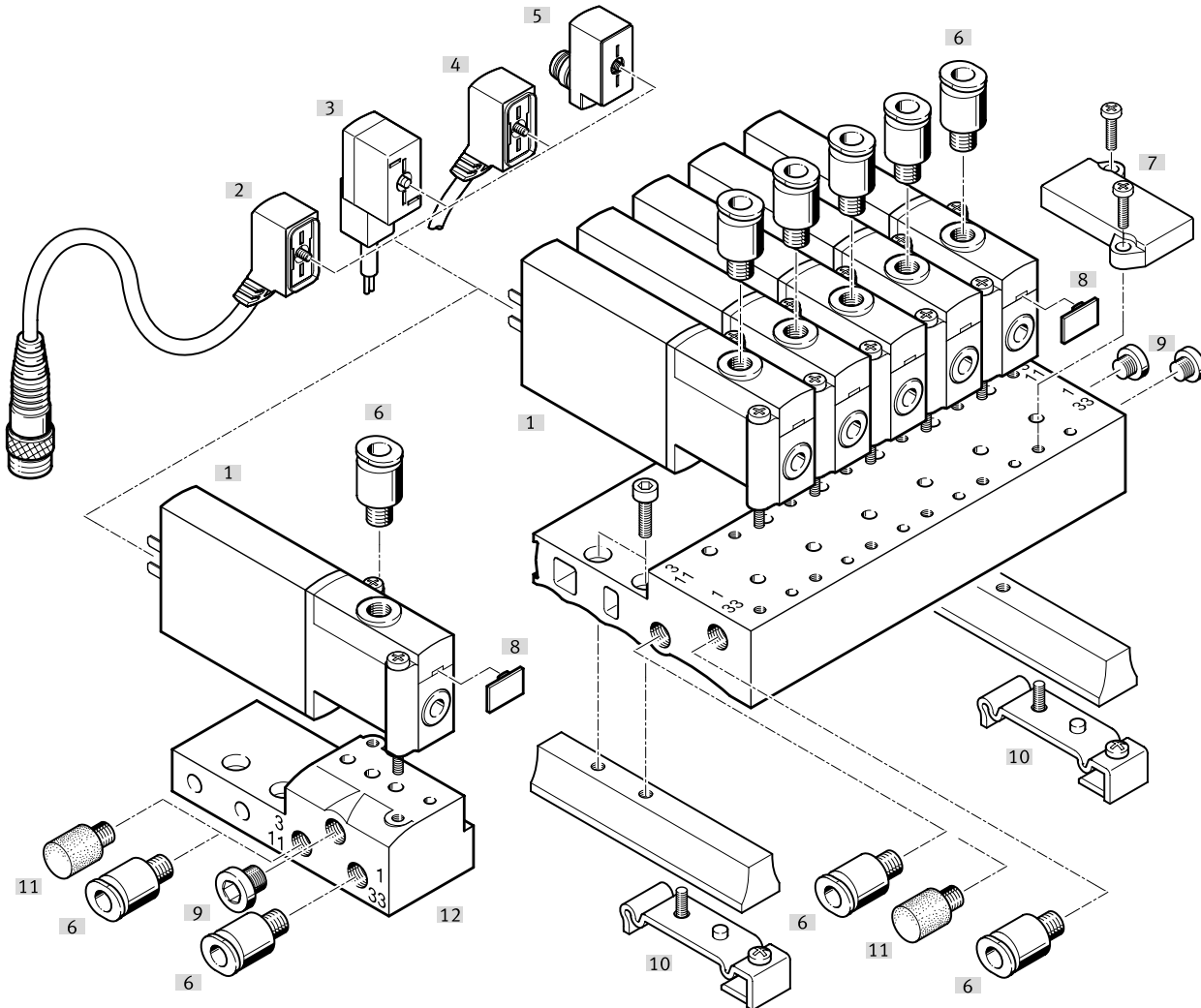

Designation	Type	Description	→ Page/Internet
[1] Semi in-line valve	MHP2	With plug vanes	29
[2] Connecting cable	NEBV	PUR cable, signal status indication with LED, plug M8x1 3-pin, IP65	29
[3] Plug socket with cable	KMYZ-4	PVC cable, without signal status indication, IP50	29
[4] Connecting cable	NEBV	PUR cable, signal status indication with LED, IP65	29
[5] Adapter	VAVE-C8	For connecting the valves via connecting cable M8 3-pin or 4-pin, IP65	29
[6] Push-in fittings	QS	For connecting compressed air tubing with standard O.D.	30
[7] Cover plate	MHAP2-BP-3	For sealing vacant positions	29
[8] Inscription label	MH-BZ-80X	For identifying the valves	30
[9] Blanking plug	B	For sealing unused ports	30
[10] H-rail mounting	MHAP2-BG-NRH-35	For mounting the manifold block on H-rails to EN 60715	29
[11] Silencer	UC	For fitting in exhaust ports	30
[12] Individual sub-base	MHA2-AS-3-M5	For semi in-line valve, the individual sub-base is also used for the sub-base valve; here the outlet port must be sealed with a blanking plug	29
Manifold block	MHP2-PR...-3	For semi in-line valves	29

Datasheet – Semi in-line valve, 3/2-way valve

Function

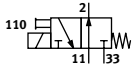
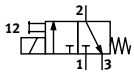

Voltage
24 V DC



Pressure
-0.09 ... +0.8 MPa



Temperature range
-5 ... +40°C



General technical data

Valve function		3/2 way, single solenoid ¹⁾
Design		Pressure relief poppet valve
Overlap		Negative overlap
Sealing principle		Soft
Reset method		Mechanical spring
Actuation type		Electrical
Type of control		Direct
Direction of flow		Reversible with restrictions ²⁾
Exhaust function		Can be throttled
Manual override		Non-detenting
Mounting position		Any
Width	[mm]	10
Grid dimension	[mm]	14
Note on grid dimension		Minimum distance between the valves is 4 mm
Nominal width	[mm]	2
Standard nominal flow rate	[l/min]	100
Type of mounting		On PR rail
Pneumatic connection	2 1, 3, 11, 33	M5 connecting thread Sub-base
Product weight	[g]	60

1) Can be used as a 2/2-way valve by sealing port 3 or 33.

2) Slight leakage can occur in the pressure range -0.8 bar to +0.5 bar.

Datasheet – Semi in-line valve, 3/2-way valve

Operating and environmental conditions		With fast-switching electronics	Without fast-switching electronics	
Operating medium		Compressed air to ISO 8573-1:2010 [7:4:4]		
Note on the operating/pilot medium		Lubricated operation possible (in which case lubricated operation will always be required)		
Operating pressure	[MPa]	-0.09 ... +0.8		
	[bar]	-0.9 ... +8		
	Reversible	[MPa]	-0.09 ... +0.1	
		[bar]	-0.9 ... +1	
	[psi]	-13.05 ... +14.5		
Ambient temperature		[°C] -5 ... +40		
Temperature of medium		[°C] -5 ... +40		
Restricted ambient temperature and temperature of medium		As a function of switching frequency (see graph)		
Corrosion resistance class CRC ¹⁾		2		
CE marking (see declaration of conformity) ³⁾		To EU EMC Directive ²⁾	-	
		To EU RoHS Directive	-	
UKCA marking (see declaration of conformity) ³⁾		To UK instructions for EMC	-	
		To UK RoHS instructions	-	
Certification		c UL us - Recognized (OL)	c UL us - Recognized (OL)	
		RCM	-	
Cleanroom class		Class 6 to ISO 14644-1		
Shock resistance		Shock test with severity level 2 to FN 942017-5 and EN 60068-2-27		
Vibration resistance		Transport application test with severity level 2 to FN 942017-4 and EN 60068-2-6		

1) More information: www.festo.com/x/topic/kbk

2) For information about the area of use, see the EC declaration of conformity at: www.festo.com/catalogue/mh2 → Support/Downloads.

If the devices are subject to usage restrictions in residential, commercial or light-industrial environments, further measures for the reduction of the emitted interference may be necessary.

3) More information: www.festo.com/catalogue/... → Support/Downloads.

Electrical data		With fast-switching electronics	Without fast-switching electronics
Electrical connection		Plug, 2-pin	
Operating voltage	[V DC]	24	
Permissible voltage fluctuations	[%]	±10	
Power consumption	[W]	5 for approx. 3 ms (high-current phase, in-rush current 1 A)	2.88
	[W]	1.25 (low-current phase)	-
Reverse polarity protection		Bipolar	
Duty cycle	[%]	100	100
Additional functions	Spark arresting		-
	Holding current reduction		-
	Protective circuit		-
Degree of protection to EN 60529		IP65	IP65

Switching times and frequencies		With fast-switching electronics	Without fast-switching electronics
Switching time	On [ms]	1.7	7
	Off [ms]	2	3.5
Tolerance for switching time	On [%]	+10 ... -30	-
	Off [%]	+10 ... -30	-
Switching time variation from 1 Hz upwards	[ms]	0.2	-
Maximum switching frequency	[Hz]	330	130

Materials	
Housing	Coated die-cast zinc
Seals	HNBR, NBR
Screws	Galvanised steel
Note on materials	RoHS-compliant
PWIS conformity	VDMA24364-B1/B2-L

Datasheet – Semi in-line valve, 3/2-way valve

Restricted ambient temperature and temperature of medium as a function of switching frequency

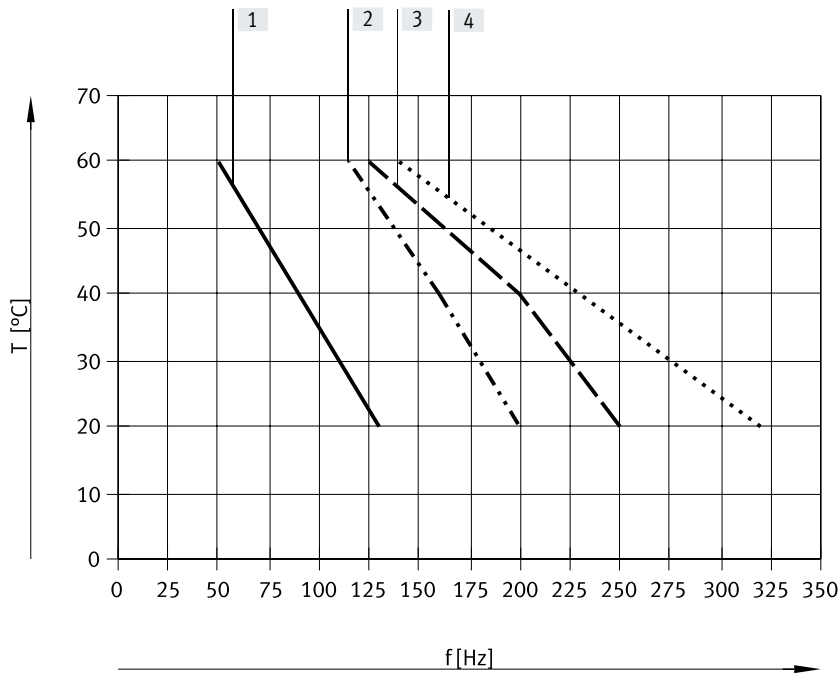

- [1] Valve manifold assembly, 6 valves, unpressurised
- [2] Valve manifold assembly, 6 valves, through-flow, 0.6 MPa
- [3] Individual valve, unpressurised
- [4] Individual valve, through-flow, 0.6 MPa

Current curve for valves with fast-switching electronics (MHP2-MS1H)

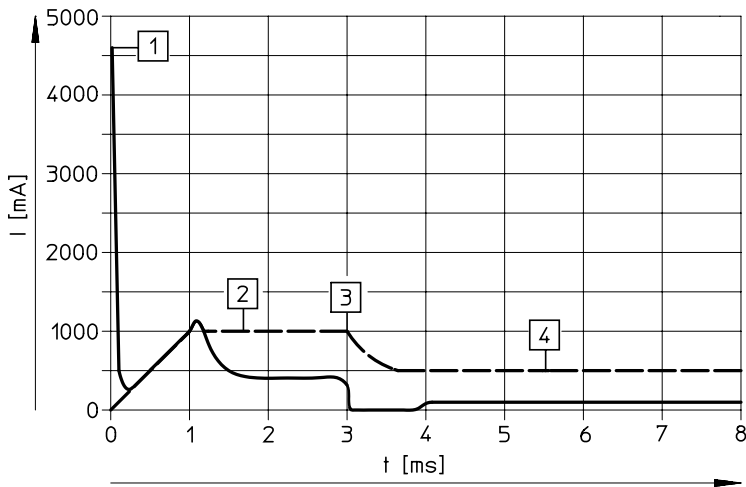

- [1] Capacitor charging
- [2] Controlled coil current 1 A
- [3] Holding current reduction
- [4] Controlled holding current 0.5 A

..... Internal current in the coil
 — External current in the supply line

Datasheet – Semi in-line valve, 3/2-way valve

Dimensions

Download CAD data → www.festo.com

Valve with plug vanes, MHP2-...-3/2...-M5

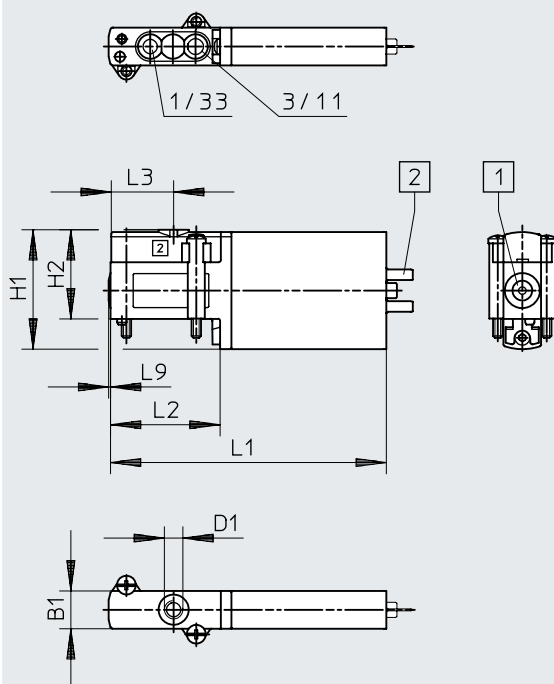

[1] Manual override, non-detenting [2] Plug vanes

Hole pattern on sub-bases

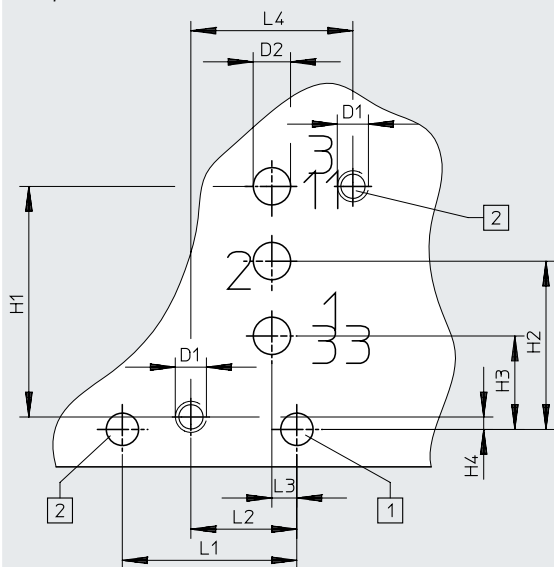

[1] Hole for coding pin, 1.7^{+0.2} mm deep [2] Mounting thread, 4.6⁺¹ mm deep

Type	B1	D1	D2 ∅	H1	H2	H3	H4	L1	L2	L3	L4	L9
MHP2-...-3/2...-M5	10	M5	-	31.6	23.6	-	-	73	29	16.5	-	0.5
Hole pattern	-	M2.5	3	18.5	13.5	7.5	1	14	8.5	2	13	-

Datasheet – Semi in-line valve, 3/2-way valve

Dimensions

Download CAD data → www.festo.com

Individual sub-base, MHA2-AS-3-M5

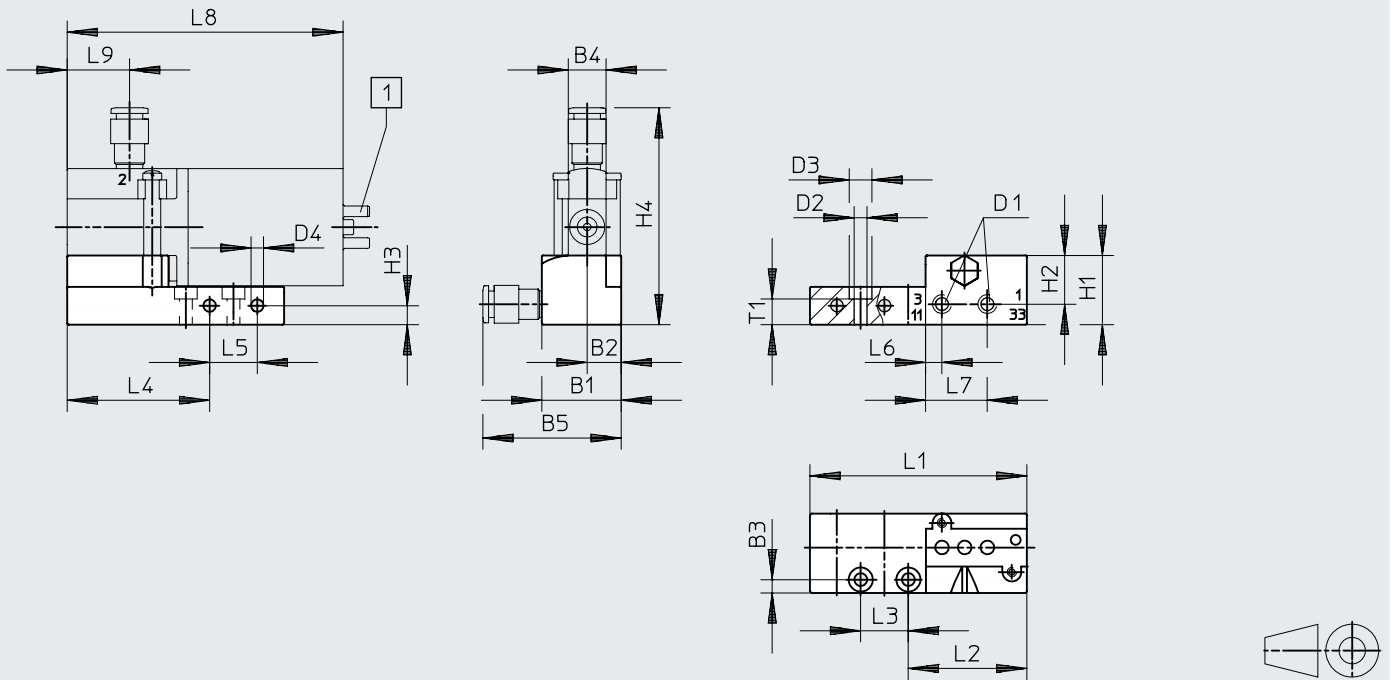

[1] Plug vanes

H-rail mounting MHAP2-BG-NRH-35

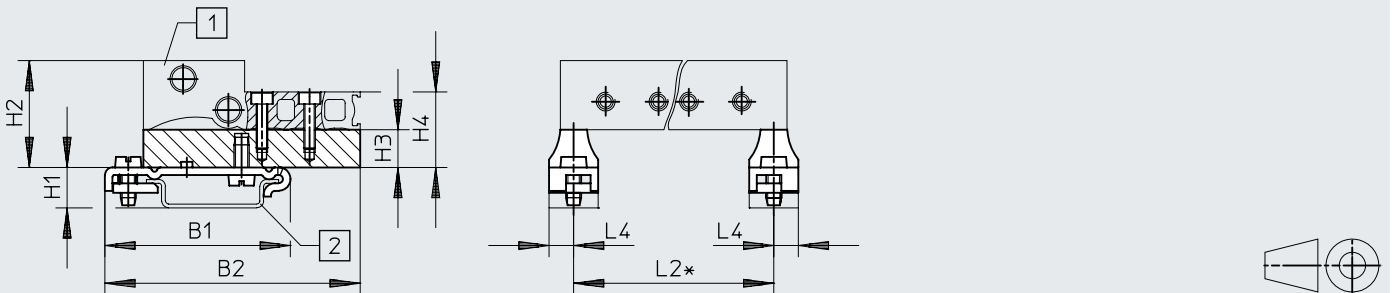

[1] Manifold block

[2] DIN mounting rail

* See dimensions table for manifold block used

Type	B1	B2	B3	B4	B5	D1	D2 ∅	D3 ∅	D4 ∅	H1	H2	H3	H4	L1	L2	L3	L4	L5	L6	L7	L8	L9	T1
MHA2-AS-3-M5	21	9	3.5	10	36.6	M5	3.4	6	3.3	18.3	12.9	5	57.4	57.4	31.4	12.6	37.7	12.6	4.3	16.3	73	16.5	6.8
MHAP2-BG-NRH-35	49.1	67.6	-	-	-	-	-	-	-	10.7	28.3	10	20	-	*	-	6.5	-	-	-	-	-	-

* See dimensions table for manifold block used

Datasheet – Semi in-line valve, 3/2-way valve

Dimensions

Download CAD data → www.festo.com

Manifold assembly, MHP2-PR...-3

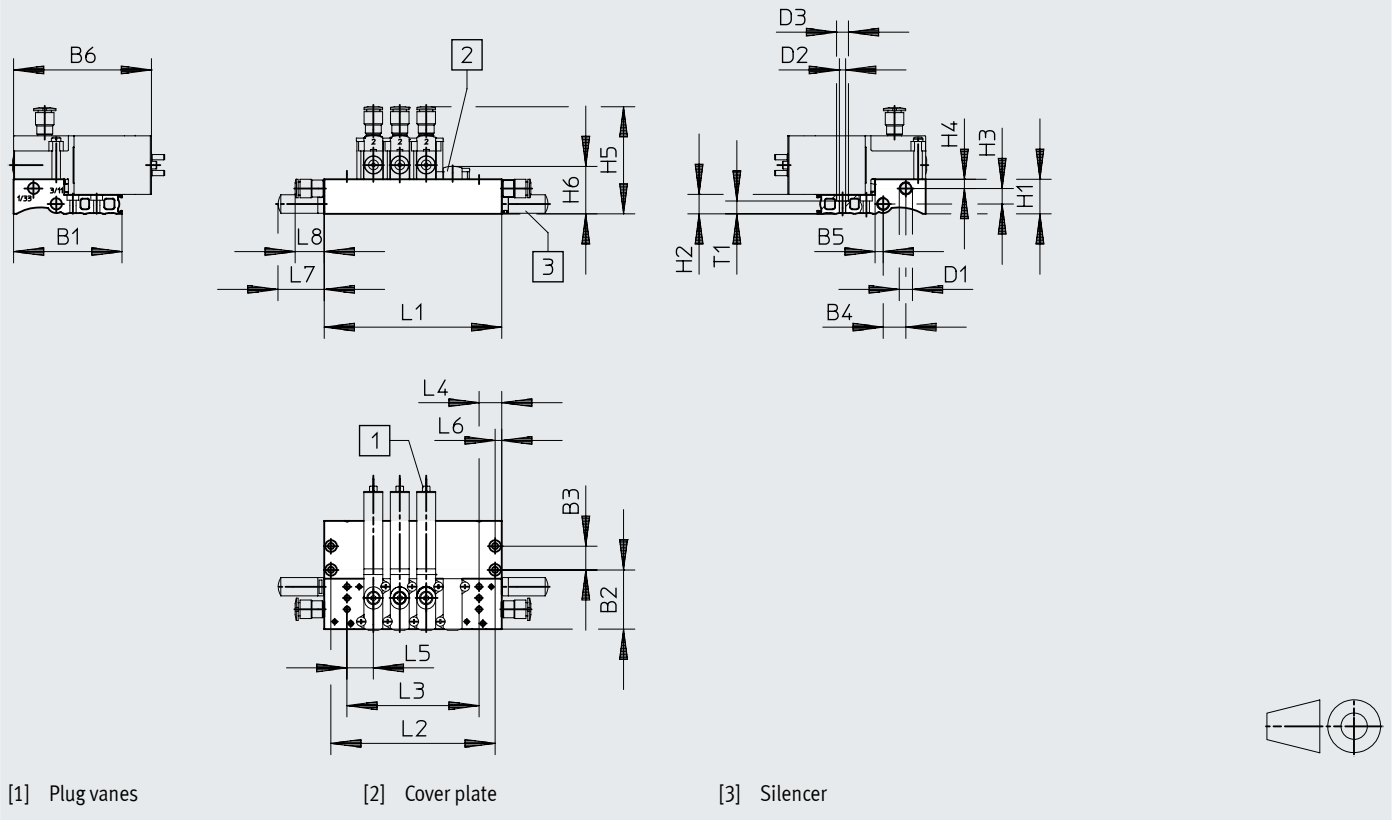





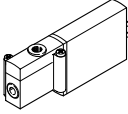

Type	B1	B2	B3	B4	B5	B6	D1	D2	D3	H1	H2	H3	H4	H5	H6	L4	L5	L6	L7	L8	T1
MHP2-PR...-3	57.4	31.4	12.6	12	4.3	73	M7	3.3	6.3	18.3	10	8.2	4.9	56.7	25.1	12	14	3.5	24.5	15.4	6.8

Type	Number of valve positions					
	2	4	6	8	10	
MHP2-PR...-3	L1	38	66	94	122	150
	L2	31	59	87	115	143
	L3	14	42	70	98	126

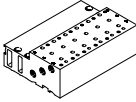

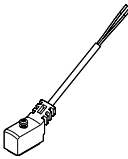
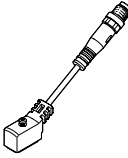

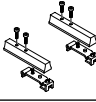
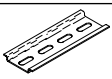
Note
Valve types 3/2G and 3/2O must not be mixed on one manifold block.

Datasheet – Semi in-line valve, 3/2-way valve

Ordering data					Part no.	Type
Valves						
	With fast-switching electronics	Switching time on 1.7 ms	Normally open	196143	MHP2-MS1H-3/2O-M5	
			Normally closed	196123	MHP2-MS1H-3/2G-M5	
	Without fast-switching electronics	Switching time on 7 ms	Normally open	196142	MHP2-M1H-3/2O-M5	
			Normally closed	196122	MHP2-M1H-3/2G-M5	
Manifold rail						
	Individual sub-base ¹⁾ Pneumatic connection: thread M5		1 valve position	197438	MHA2-AS-3-M5	
	Manifold block Pneumatic connection: thread M7		2 valve positions	197442	MHP2-PR2-3	
			4 valve positions	197443	MHP2-PR4-3	
			6 valve positions	197444	MHP2-PR6-3	
			8 valve positions	197445	MHP2-PR8-3	
			10 valve positions	197446	MHP2-PR10-3	
Cover plate						
	Vacant valve positions must be sealed with a cover plate			197470	MHAP2-BP-3	
Connecting cable Datasheets → Internet: nebv						
	2-pin socket, open cable end 2-wire	PUR cable, degree of protection IP65	Signal status indication with LED	Length 2.5 m	8047671	NEBV-Z4WA2L-P-E-2.5-N-LE2-S1
				Length 5 m	8047672	NEBV-Z4WA2L-P-E-5-N-LE2-S1
				Length 10 m	8047670	NEBV-Z4WA2L-P-E-10-N-LE2-S1
		PVC cable, degree of protection IP40	Without signal status indication	Length 0.5 m	193690	KMYZ-4-24-0.5-B
				Length 2.5 m	193691	KMYZ-4-24-2.5-B
	2-pin socket, plug M8x1 3-pin	PUR cable, degree of protection IP65	Signal status indication with LED	Length 0.5 m	8047673	NEBV-Z4WA2L-P-E-0.5-N-M8G3-S1
				Length 2.5 m	8047674	NEBV-Z4WA2L-P-E-2.5-N-M8G3-S1
Adapter						
	2-pin socket	Signal status indi- cation with LED	Plug M8, 3-pin	571686	VAVE-C8-1R8	
			Plug M8, 4-pin	573194	VAVE-C8-1R1	
H-rail mounting						
	For 3/2-way solenoid valves			525053	MHAP2-BG-NRH-35	
H-rail						
	To EN 60715		2 m	35430	NRH-35-2000	

1) Seal ports 2 and 4 on the individual sub-base with blanking plugs. These ports on the individual sub-base have no function when using semi in-line valves.

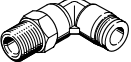
Datasheet – Semi in-line valve, 3/2-way valve

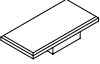
Ordering data			Part no.	Type	
Silencer			Datasheets → Internet: uc		
	With threaded connection	M5	1 piece	165003	UC-M5
			50 pieces	534217	UC-M5-50
		M7	1 piece	161418	UC-M7
			50 pieces	534218	UC-M7-50
Push-in fitting			Datasheets → Internet: qs		
	Male thread M5 with internal hex for tubing O.D.	4 mm	10 pieces	153315	QSM-M5-4-I
		6 mm	10 pieces	153317	QSM-M5-6-I
	Male thread M7 with internal hex for tubing O.D.	4 mm	10 pieces	153319	QSM-M7-4-I
		6 mm	100 pieces	133006	QSM-M7-4-I-100
	Male thread M5 with external hex, push-in L-fitting rotatable through 360°, for tubing O.D.	4 mm	10 pieces	153333	QSML-M5-4
			100 pieces	130771	QSML-M5-4-100
		6 mm	10 pieces	153335	QSML-M5-6
			100 pieces	130772	QSML-M5-6-100
	Male thread M7 with external hex, push-in L-fitting rotatable through 360°, for tubing O.D.	4 mm	10 pieces	186352	QSML-M7-4
			100 pieces	130773	QSML-M7-4-100
		6 mm	10 pieces	186353	QSML-M7-6
			100 pieces	130774	QSML-M7-6-100
Blanking plug					
	For thread M5	10 pieces	3843	B-M5	
	For thread M7	10 pieces	174309	B-M7	
Inscription label					
	For solenoid valve	80 pieces in a frame	197259	MH-BZ-80X	

Peripherals overview – Semi in-line valve, 5/2-way valve

Connection via plug vanes

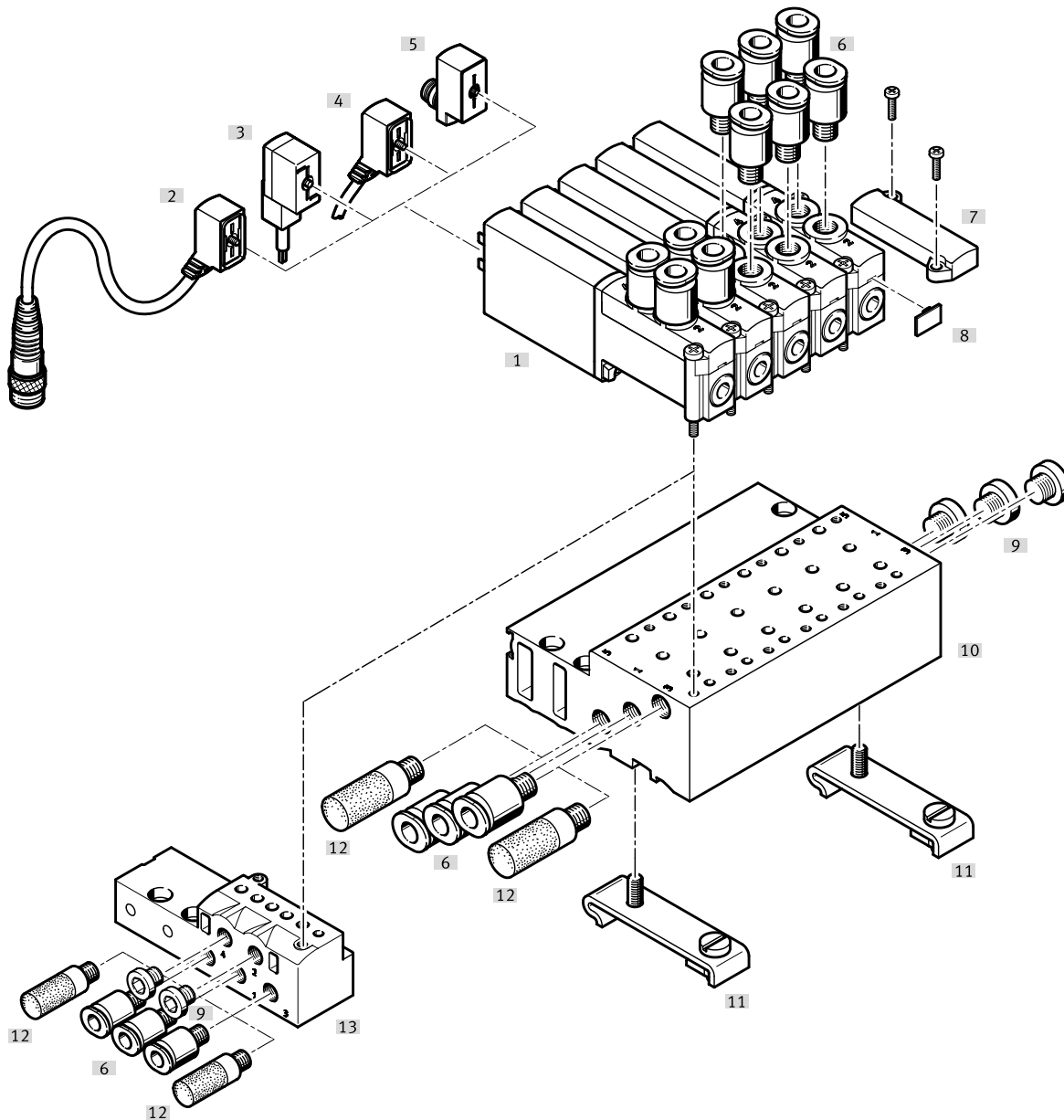



Designation	Type	Description	→ Page/Internet
[1] Semi in-line valve	MHP2	With plug vanes	38
[2] Connecting cable	NEBV	PUR cable, signal status indication with LED, plug M8x1 3-pin, IP65	38
[3] Plug socket with cable	KMYZ-4	PVC cable, without signal status indication, IP50	38
[4] Connecting cable	NEBV	PUR cable, signal status indication with LED, IP65	38
[5] Adapter	VAVE-C8	For connecting the valves via connecting cable M8 3-pin or 4-pin, IP65	38
[6] Push-in fittings	QS	For connecting compressed air tubing with standard O.D.	39
[7] Cover plate	MHAP2-BP-5	For sealing vacant positions	38
[8] Inscription label	MH-BZ-80X	For identifying the valves	39
[9] Blanking plug	B	For sealing unused ports	39
[10] Manifold block	MHP2-PR...-5	For semi in-line valves	38
[11] H-rail mounting	CPV10/14-VI-BG-NRH-35	For mounting the manifold block on H-rails to EN 60715	38
[12] Silencer	UC	For fitting in exhaust ports	39
[13] Individual sub-base	MHA2-AS-5-M5	For semi in-line valve, the individual sub-base is also used for sub-base valves and must be sealed with a blanking plug here	38

Datasheet – Semi in-line valve, 5/2-way valves

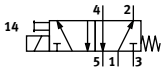
Function



-  - Voltage
24 V DC
-  - Pressure
-0.09 ... +0.8 MPa
-  - Temperature range
-5 ... +40°C



General technical data

Valve function	5/2-way, single solenoid	
Design	Pressure relief poppet valve	
Overlap	Negative overlap	
Sealing principle	Soft	
Reset method	Mechanical spring	
Actuation type	Electrical	
Type of control	Direct	
Direction of flow	Not reversible	
Exhaust function	Can be throttled	
Manual override	Non-detenting	
Mounting position	Any	
Width	[mm]	10
Grid dimension	[mm]	14
Note on grid dimension	Minimum distance between the valves is 4 mm	
Nominal width	[mm]	2
Standard nominal flow rate	[l/min]	90
Type of mounting	On PR rail	
Max. tightening torque for valve mounting	[Nm]	0.4
Pneumatic connection	1, 3, 5	Sub-base
	2, 4	M5 connecting thread
Max. tightening torque of fitting	[Nm]	1.5
Product weight	[g]	70

Datasheet – Semi in-line valve, 5/2-way valves

Operating and environmental conditions		
Operating medium		Compressed air to ISO 8573-1:2010 [7:4:4]
Note on the operating/pilot medium		Lubricated operation possible (in which case lubricated operation will always be required)
Operating pressure	[MPa]	-0.09 ... +0.8
	[bar]	-0.9 ... +8
Ambient temperature	[°C]	-5 ... +40
Temperature of medium	[°C]	-5 ... +40
Restricted ambient temperature and temperature of medium		As a function of switching frequency
Corrosion resistance class CRC ¹⁾		2
CE marking (see declaration of conformity) ³⁾		To EU EMC Directive ²⁾
		To EU RoHS Directive
UKCA marking (see declaration of conformity) ³⁾		To UK instructions for EMC
		To UK RoHS instructions
Certification		c UL us - Recognized (OL)
		RCM
Cleanroom class		Class 6 to ISO 14644-1
Shock resistance		Shock test with severity level 2 to FN 942017-5 and EN 60068-2-27
Vibration resistance		Transport application test with severity level 2 to FN 942017-4 and EN 60068-2-6

1) More information: www.festo.com/x/topic/kbk

2) For information about the area of use, see the EC declaration of conformity at: www.festo.com/catalogue/mh2 → Support/Downloads.

If the devices are subject to usage restrictions in residential, commercial or light-industrial environments, further measures for the reduction of the emitted interference may be necessary.

3) More information: www.festo.com/catalogue/... → Support/Downloads.

Electrical data		
Electrical connection		Plug, 2-pin
Operating voltage	[V DC]	24
Permissible voltage fluctuations	[%]	±10
Power consumption	Low-current phase	[W] 1.625
	High-current phase	[W] 6.5
Reverse polarity protection		Bipolar
Duty cycle	[%]	100
Additional functions		Spark arresting
		Holding current reduction
		Protective circuit
Degree of protection to EN 60529		IP65

Switching times and frequencies		
Switching time	On	[ms] 1.9
	Off	[ms] 1.7
Tolerance for switching time	On	[%] +10 ... -30
	Off	[%] +10 ... -30
Maximum switching frequency	[Hz]	300
Switching time variation from 1 Hz upwards	[ms]	0.2

Materials	
Housing	Coated die-cast zinc
Seals	HNBR, NBR
Screws	Galvanised steel
Note on materials	RoHS-compliant
PWIS conformity	VDMA24364-B1/B2-L

Datasheet – Semi in-line valve, 5/2-way valves

Restricted ambient temperature and temperature of medium as a function of switching frequency

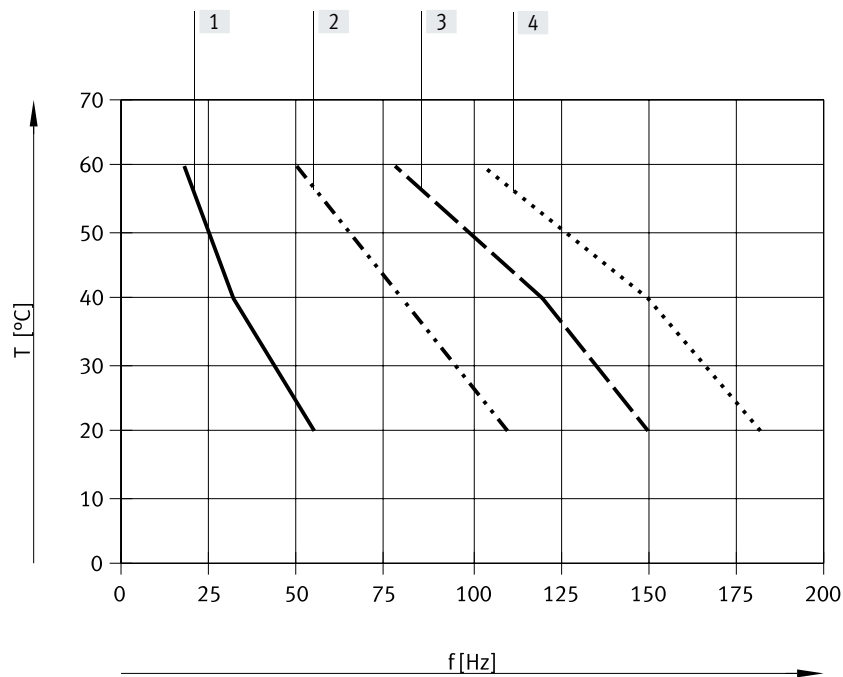

- [1] Valve manifold assembly, 6 valves, unpressurised
- [2] Valve manifold assembly, 6 valves, through-flow, 0.6 MPa
- [3] Individual valve, unpressurised
- [4] Individual valve, through-flow, 0.6 MPa

Current curve for valves with fast-switching electronics (MHP2-MS1H)

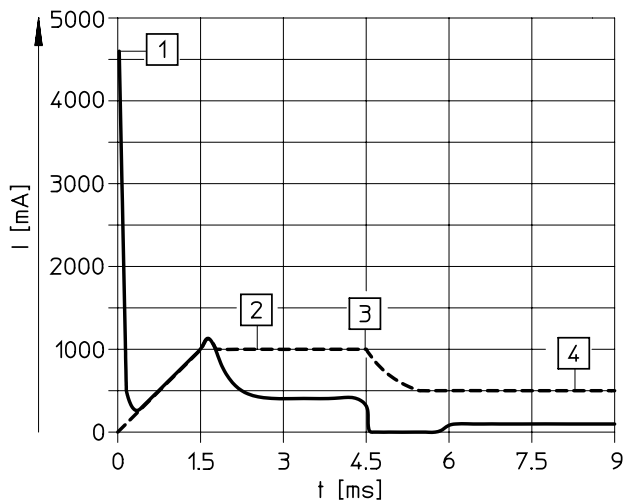

- [1] Capacitor charging
- [2] Controlled coil current 1 A
- [3] Holding current reduction
- [4] Controlled holding current 0.5 A

----- Internal current in the coil
 — External current in the supply line

Datasheet – Semi in-line valve, 5/2-way valves

Dimensions

Download CAD data → www.festo.com

Valve with plug vanes, MHP2-...-5/2...-M5

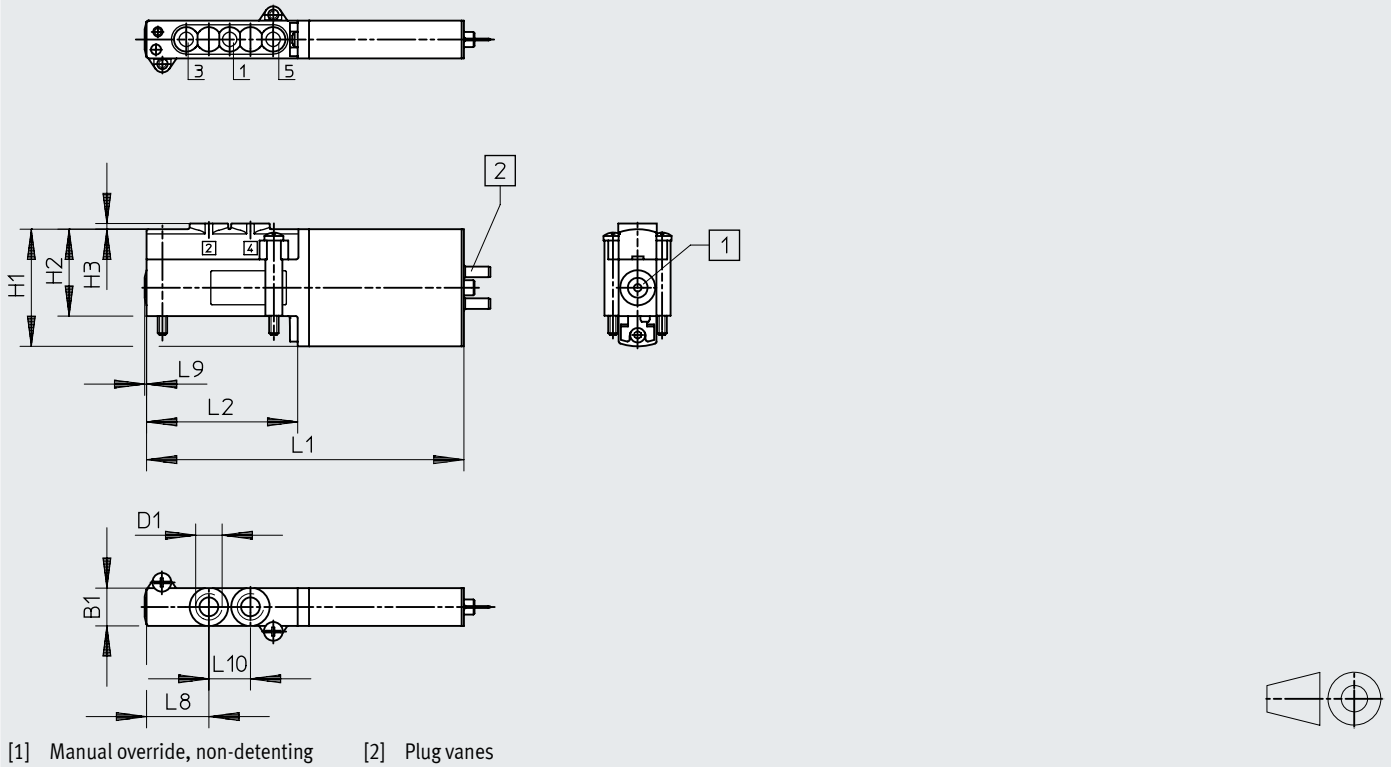

Hole pattern on sub-bases

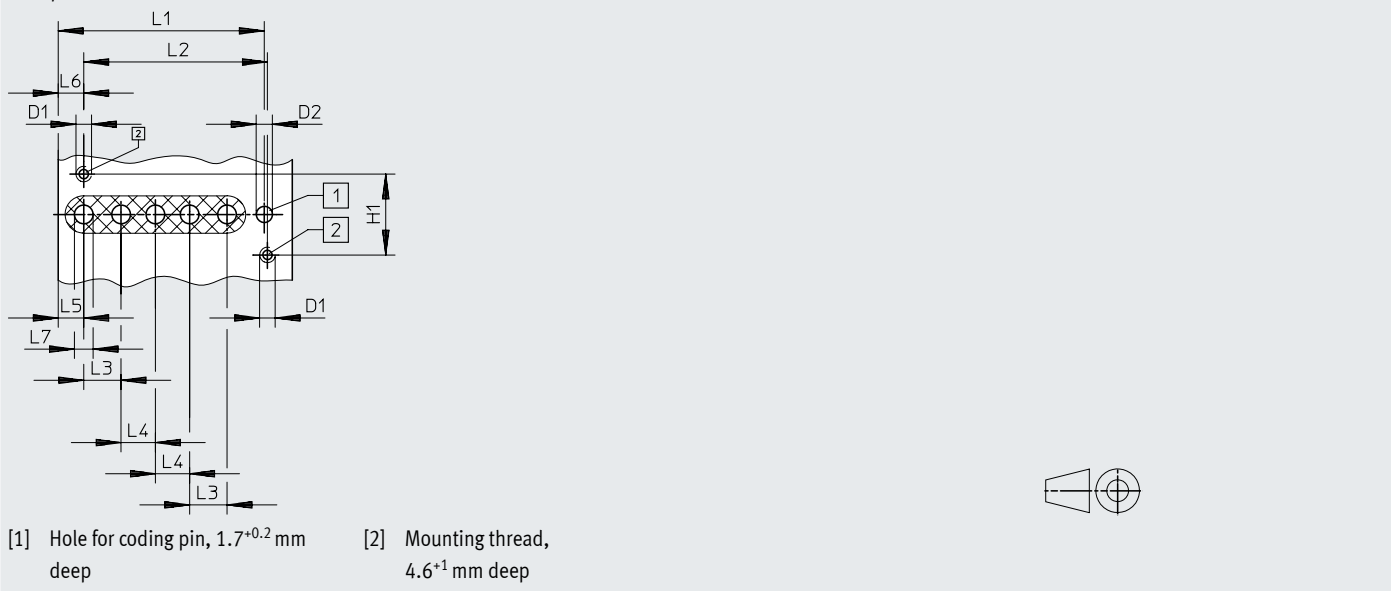

Type	B1	D1	D2 ∅	H1	H2	H3	H4	L1	L2	L3	L4	L5	L6	L7	L8	L9	L10
MHP2-...-5/2...-M5	10	M5	-	31	23	1.5	-	84	40	-	-	-	-	-	16.5	0.5	11
Hole pattern	-	M2.5	2.6	13	-	-	-	33.1	29.5	6	5.5	4.1	4.1	3	-	-	-

Note
Ports 2 and 4 are not required with semi in-line valves.

Datasheet – Semi in-line valve, 5/2-way valves

Dimensions

Download CAD data → www.festo.com

Individual sub-base, MHA2-AS-5-M5

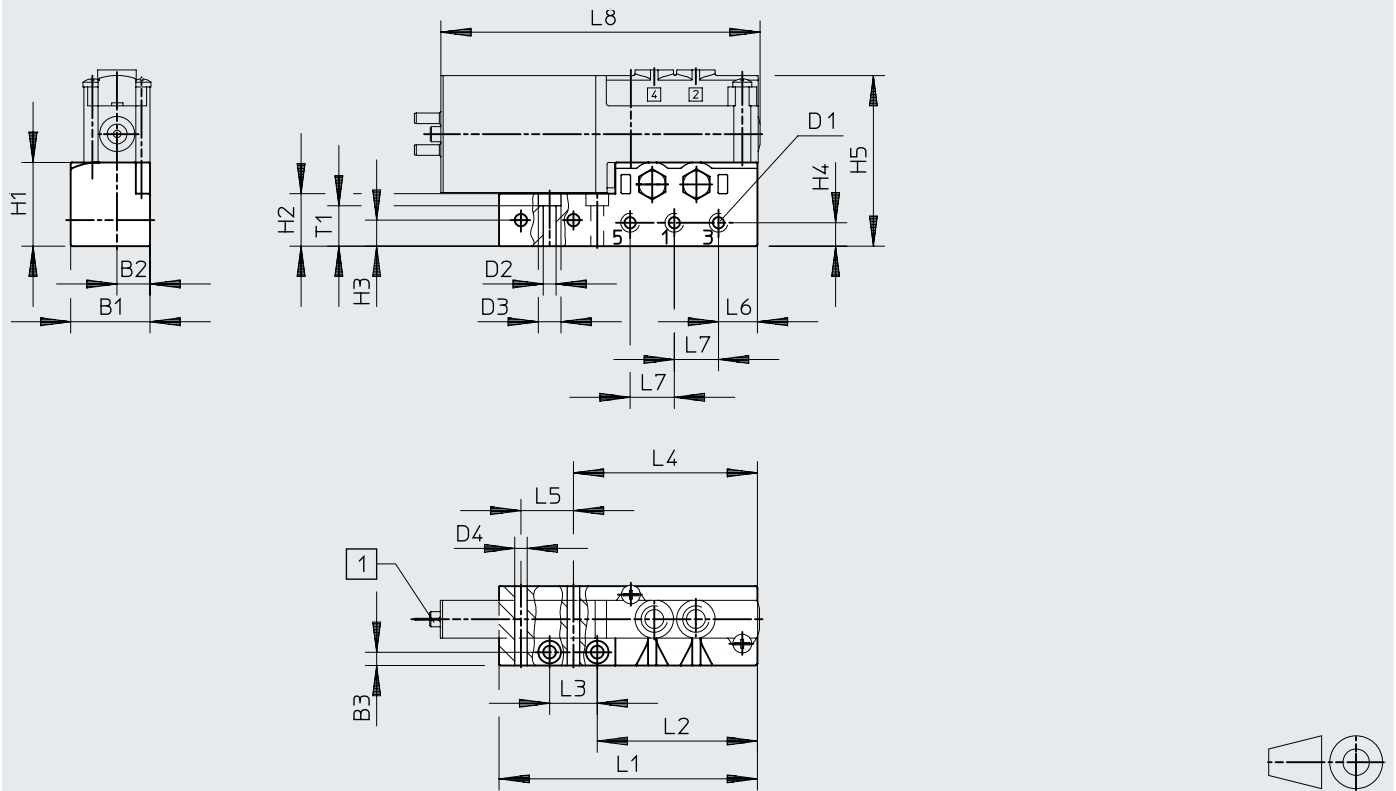

[1] Plug vanes

Type	B1	B2	B3	D1	D2 ∅	D3 ∅	D4 ∅	H1	H2	H3	H4	H5	L1	L2	L3	L4	L5	L6	L7	L8	T1
MHA2-AS-5-M5	21	8.8	3.5	M5	3.4	6	3.3	22.2	13.9	6.9	6.2	45.2	68.4	42.4	12.6	48.7	13.9	10.3	11.7	84.5	10.7

Datasheet – Semi in-line valve, 5/2-way valves

Dimensions

Download CAD data → www.festo.com

Manifold assembly, MHP2-PR...-5

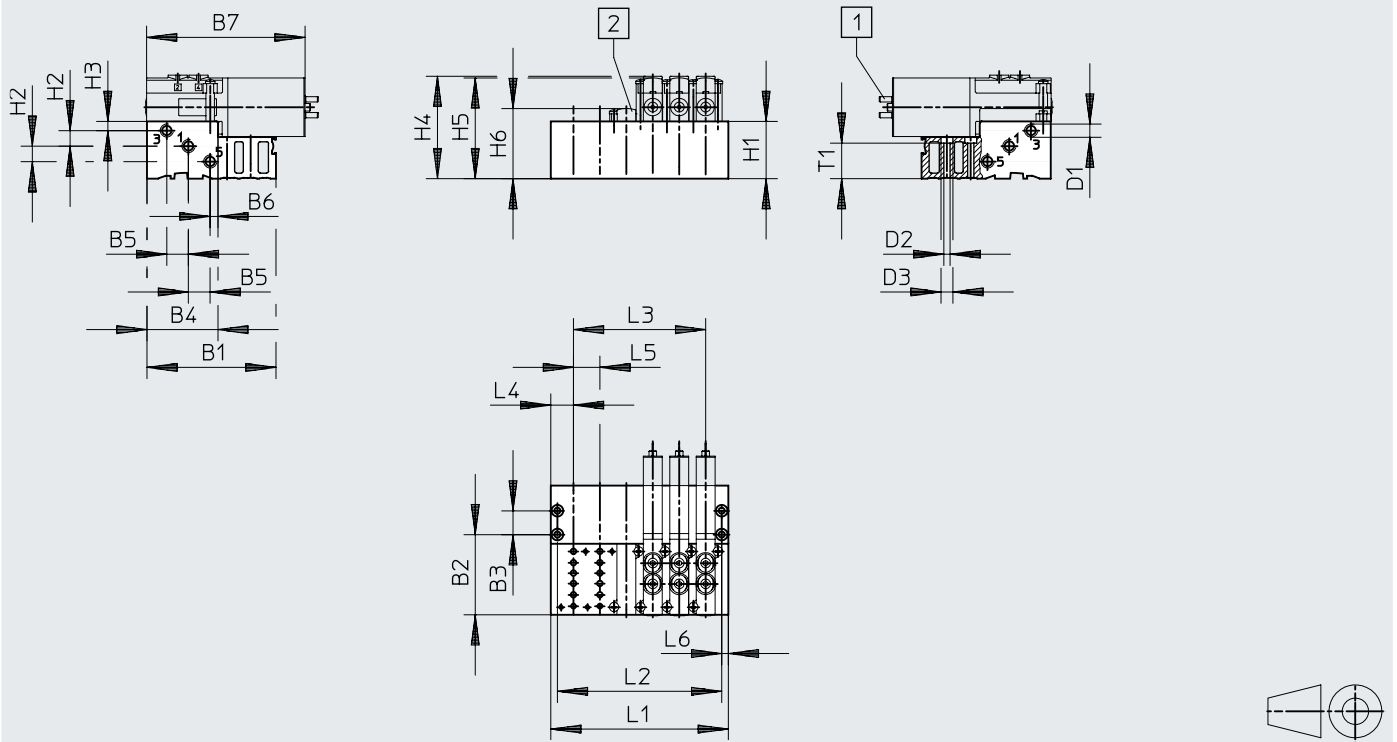







[1] Plug vanes

[2] Cover plate

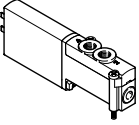
Type	B1	B2	B3	B4	B5	B6	B7	D1	D2 ∅	D3 ∅	H1	H2	H3	H4	H5	H6	L4	L5	L6	T1
MHP2-PR...-5	68.4	42.4	12.6	37.6	11.5	4.1	84	M7	3.3	6.3	30.3	8.2	4.9	54.8	53.3	37.1	12	14	3.5	18.8

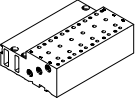

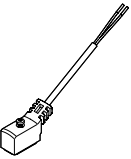
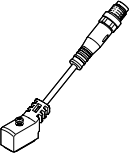

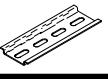
Type	Number of valve positions					
	2	4	6	8	10	
MHP2-PR...-5	L1	38	66	94	122	150
	L2	31	59	87	115	143
	L3	14	42	70	98	126

Datasheet – Semi in-line valve, 5/2-way valve

Ordering data				Part no.	Type	
Valves						
	With fast-switching electronics	Switching time on 1.9 ms		525105	MHP2-MS1H-5/2-M5	
Manifold rail						
	Individual sub-base ¹⁾ Pneumatic connection: thread M5	1 valve position	525120	MHA2-AS-5-M5		
	Manifold block Pneumatic connection 1, 3, 5: thread M7	2 valve positions	525122	MHP2-PR2-5		
		4 valve positions	525123	MHP2-PR4-5		
		6 valve positions	525124	MHP2-PR6-5		
		8 valve positions	525125	MHP2-PR8-5		
		10 valve positions	525126	MHP2-PR10-5		
Cover plate						
	Vacant valve positions must be sealed with a cover plate.			525132	MHAP2-BP-5	
Connecting cable Datasheets → Internet: nebv						
	2-pin socket, open cable end 2-wire	PUR cable, degree of protection IP65	Signal status indication with LED	Length 2.5 m	8047671	NEBV-Z4WA2L-P-E-2.5-N-LE2-S1
				Length 5 m	8047672	NEBV-Z4WA2L-P-E-5-N-LE2-S1
				Length 10 m	8047670	NEBV-Z4WA2L-P-E-10-N-LE2-S1
		PVC cable, degree of protection IP40	Without signal status indication	Length 0.5 m	193690	KMYZ-4-24-0.5-B
				Length 2.5 m	193691	KMYZ-4-24-2.5-B
	2-pin socket, plug M8x1 3-pin	PUR cable, degree of protection IP65	Signal status indication with LED	Length 0.5 m	8047673	NEBV-Z4WA2L-P-E-0.5-N-M8G3-S1
				Length 2.5 m	8047674	NEBV-Z4WA2L-P-E-2.5-N-M8G3-S1
Adapter						
	2-pin socket	Signal status indication with LED	Plug M8, 3-pin	571686	VAVE-C8-1R8	
			Plug M8, 4-pin	573194	VAVE-C8-1R1	
H-rail mounting						
	For 5/2-way solenoid valves			162556	CPV10/14-VI-BG-NRH-35	
H-rail						
	To EN 60715	2 m	35430	NRH-35-2000		

1) Seal ports 2 and 4 on the individual sub-base with blanking plugs. These ports on the individual sub-base have no function when using semi in-line valves.

Datasheet – Semi in-line valve, 5/2-way valve

Ordering data		Part no.	Type		
Silencer Datasheets → Internet: uc					
	With threaded connection	M5	1 piece	165003	UC-M5
			50 pieces	534217	UC-M5-50
		M7	1 piece	161418	UC-M7
			50 pieces	534218	UC-M7-50
Push-in fitting Datasheets → Internet: qs					
	Male thread M5 with internal hex for tubing O.D.	4 mm	10 pieces	153315	QSM-M5-4-I
		6 mm	10 pieces	153317	QSM-M5-6-I
	Male thread M7 with internal hex for tubing O.D.	4 mm	10 pieces	153319	QSM-M7-4-I
			100 pieces	133006	QSM-M7-4-I-100
	Male thread M5 with external hex, push-in L-fitting rotatable through 360°, for tubing O.D.	4 mm	10 pieces	153333	QSML-M5-4
			100 pieces	130771	QSML-M5-4-100
		6 mm	10 pieces	153335	QSML-M5-6
			100 pieces	130772	QSML-M5-6-100
	Male thread M7 with external hex, push-in L-fitting rotatable through 360°, for tubing O.D.	4 mm	10 pieces	186352	QSML-M7-4
			100 pieces	130773	QSML-M7-4-100
		6 mm	10 pieces	186353	QSML-M7-6
			100 pieces	130774	QSML-M7-6-100
Blanking plug					
	For thread M5	10 pieces	3843	B-M5	
	For thread M7	10 pieces	174309	B-M7	
Inscription label					
	For solenoid valve	80 pieces in a frame	197259	MH-BZ-80X	

Peripherals overview – Sub-base valve, 3/2-way valve

Connection with plug vanes – Connection with moulded-in cable

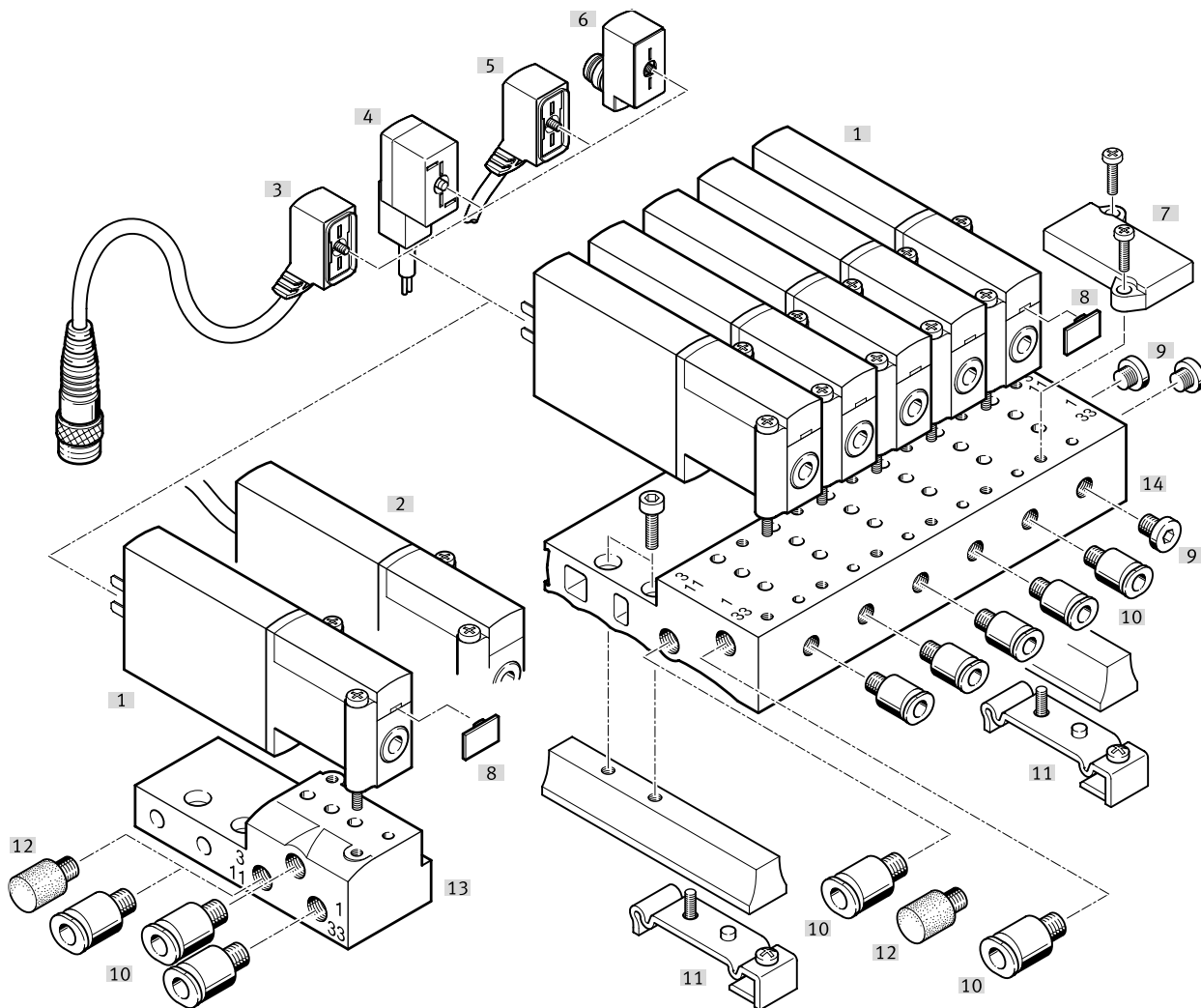



Designation	Type	Description	→ Page/Internet
[1] Sub-base valve	MHA2	With plug vanes	46
[2] Sub-base valve	MHA2-...-K	With moulded-in cable, IP55	47
[3] Connecting cable	NEBV	PUR cable, signal status indication with LED, plug M8x1 3-pin, IP65	47
[4] Plug socket with cable	KMYZ-4	PVC cable, without signal status indication, IP50	47
[5] Connecting cable	NEBV	PUR cable, signal status indication with LED, IP65	47
[6] Adapter	VAVE-C8	For connecting the valves via connecting cable M8 3-pin or 4-pin, IP65	48
[7] Cover plate	MHAP2-BP-3	For sealing vacant positions	47
[8] Inscription label	MH-BZ-80X	For identifying the valves	48
[9] Blanking plug	B	For sealing unused ports	48
[10] Push-in fittings	QS	For connecting compressed air tubing with standard O.D.	48
[11] H-rail mounting	MHAP2-BG-NRH-35	For mounting the manifold block on H-rails to EN 60715	48
[12] Silencer	UC	For fitting in exhaust ports	48
[13] Individual sub-base	MHA2-AS-3-M5	For sub-base valve	47
[14] Manifold block	MHA2-PR...-3-M5	For sub-base valve	47

Datasheet – Sub-base valve, 3/2-way valve

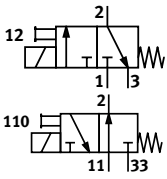
Function



-  - Voltage
24 V DC
-  - Pressure
-0.09 ... +0.8 MPa
-  - Temperature range
-5 ... +40°C



General technical data

Valve function	3/2 way, single solenoid ¹⁾
Design	Pressure relief poppet valve
Overlap	Negative overlap
Sealing principle	Soft
Reset method	Mechanical spring
Actuation type	Electrical
Type of control	Direct
Direction of flow	Reversible with restrictions
Exhaust function	Can be throttled
Manual override	Non-detenting
Mounting position	Any
Width	[mm] 10
Grid dimension	[mm] 14
Note on grid dimension	Minimum distance between the valves is 4 mm
Nominal width	[mm] 2
Standard nominal flow rate	[l/min] 100
Type of mounting	On sub-base
Pneumatic connection	Sub-base
Product weight	[g] 60

1) Can be used as a 2/2-way valve by sealing port 3 or 33

Datasheet – Sub-base valve, 3/2-way valve

Operating and environmental conditions		With fast-switching electronics	Without fast-switching electronics	
Operating medium		Compressed air to ISO 8573-1:2010 [7:4:4]		
Note on the operating/pilot medium		Lubricated operation possible (in which case lubricated operation will always be required)		
Operating pressure	[MPa]	-0.09 ... +0.8		
	[bar]	-0.9 ... +8		
	Reversible	[MPa]	-0.09 ... +0.1	
		[bar]	-0.9 ... +1	
	[psi]	-13.05 ... +14.5		
Ambient temperature		[°C] -5 ... +40		
Temperature of medium		[°C] -5 ... +40		
Restricted ambient temperature and temperature of medium		As a function of switching frequency (see graph)		
Corrosion resistance class CRC ¹⁾		2		
CE marking (see declaration of conformity) ³⁾		To EU EMC Directive ²⁾	-	
		To EU RoHS Directive	-	
UKCA marking (see declaration of conformity) ³⁾		To UK instructions for EMC	-	
		To UK RoHS instructions	-	
Certification		c UL us - Recognized (OL)	c UL us - Recognized (OL)	
		RCM	-	
Cleanroom class		Class 6 to ISO 14644-1		
Shock resistance		Shock test with severity level 2 to FN 942017-5 and EN 60068-2-27		
Vibration resistance		Transport application test with severity level 2 to FN 942017-4 and EN 60068-2-6		

1) More information: www.festo.com/x/topic/kbk

2) For information about the area of use, see the EC declaration of conformity at: www.festo.com/catalogue/mh2 → Support/Downloads.

If the devices are subject to usage restrictions in residential, commercial or light-industrial environments, further measures for the reduction of the emitted interference may be necessary.

3) More information: www.festo.com/catalogue/... → Support/Downloads.

Electrical data		With fast-switching electronics	Without fast-switching electronics
Electrical connection		2-pin plug or cable	
Operating voltage	[V DC]	24	
Permissible voltage fluctuations	[%]	±10	
Power consumption	[W]	5 for approx. 3 ms (high-current phase, inrush current 1 A)	2.88
	[W]	1.25 (low-current phase)	-
Reverse polarity protection		Bipolar	
Duty cycle	[%]	100	100
Additional functions		Spark arresting	-
		Holding current reduction	-
		Protective circuit	-
Degree of protection to EN 60529	Electrical connection: 2-pin plug	IP65	IP65
	Electrical connection: cable	IP55	IP55

Switching times and frequencies		With fast-switching electronics	Without fast-switching electronics
Switching time	On [ms]	1.7	7
	Off [ms]	2	3.5
Tolerance for switching time	On [%]	+10 ... -30	-
	Off [%]	+10 ... -30	-
Switching time variation from 1 Hz upwards	[ms]	0.2	-
Maximum switching frequency	[Hz]	330	130

Materials	
Housing	Coated die-cast zinc
Cable sheath	PUR
Seals	HNBR, NBR
Screws	Galvanised steel
Note on materials	Free of copper and PTFE
PWIS conformity	VDMA24364-B1/B2-L

Datasheet – Sub-base valve, 3/2-way valve

Restricted ambient temperature and temperature of medium as a function of switching frequency

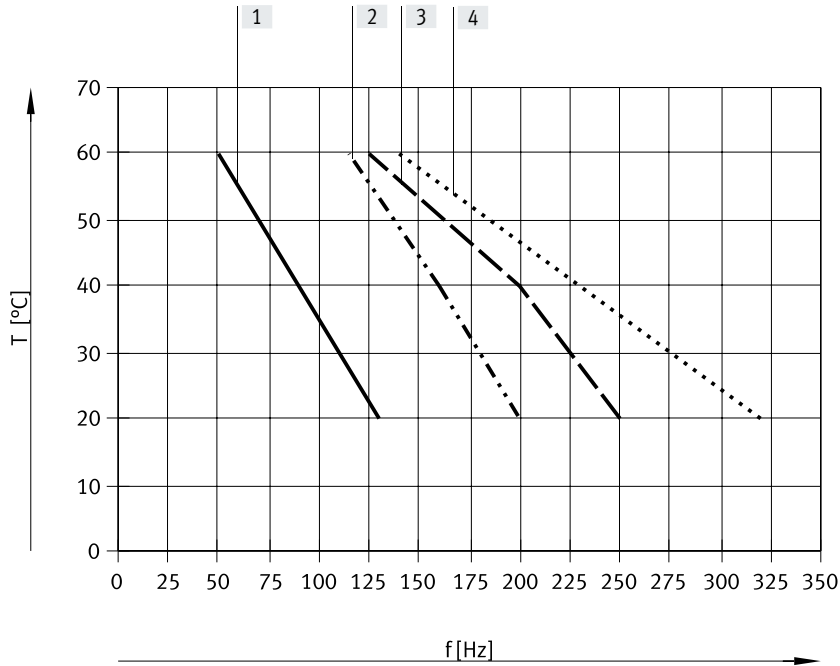

- [1] Valve manifold assembly, 6 valves, unpressurised
- [2] Valve manifold assembly, 6 valves, through-flow, 0.6 MPa
- [3] Individual valve, unpressurised
- [4] Individual valve, through-flow, 0.6 MPa

Current curve for valves with fast-switching electronics (MHA2-MS1H)

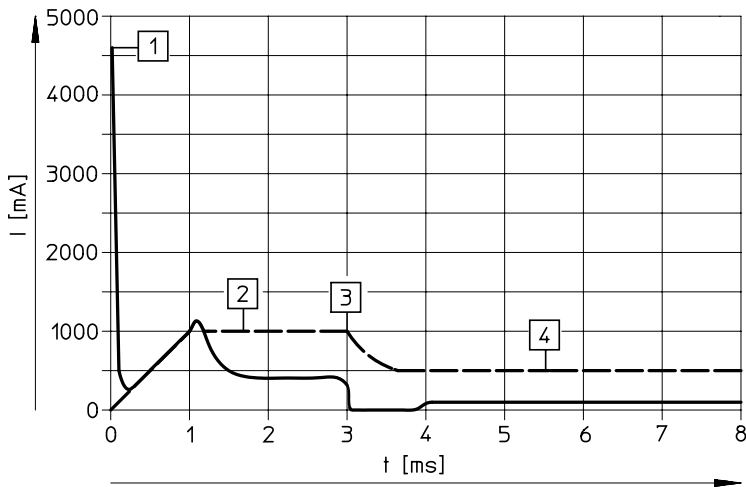

- [1] Capacitor charging
- [2] Controlled coil current 1 A
- [3] Holding current reduction
- [4] Controlled holding current 0.5 A

----- Internal current in the coil
 — External current in the supply line

Datasheet – Sub-base valve, 3/2-way valve

Dimensions

Download CAD data → www.festo.com

Valve with plug vanes or moulded-in cable, MHA2-...-3/2...

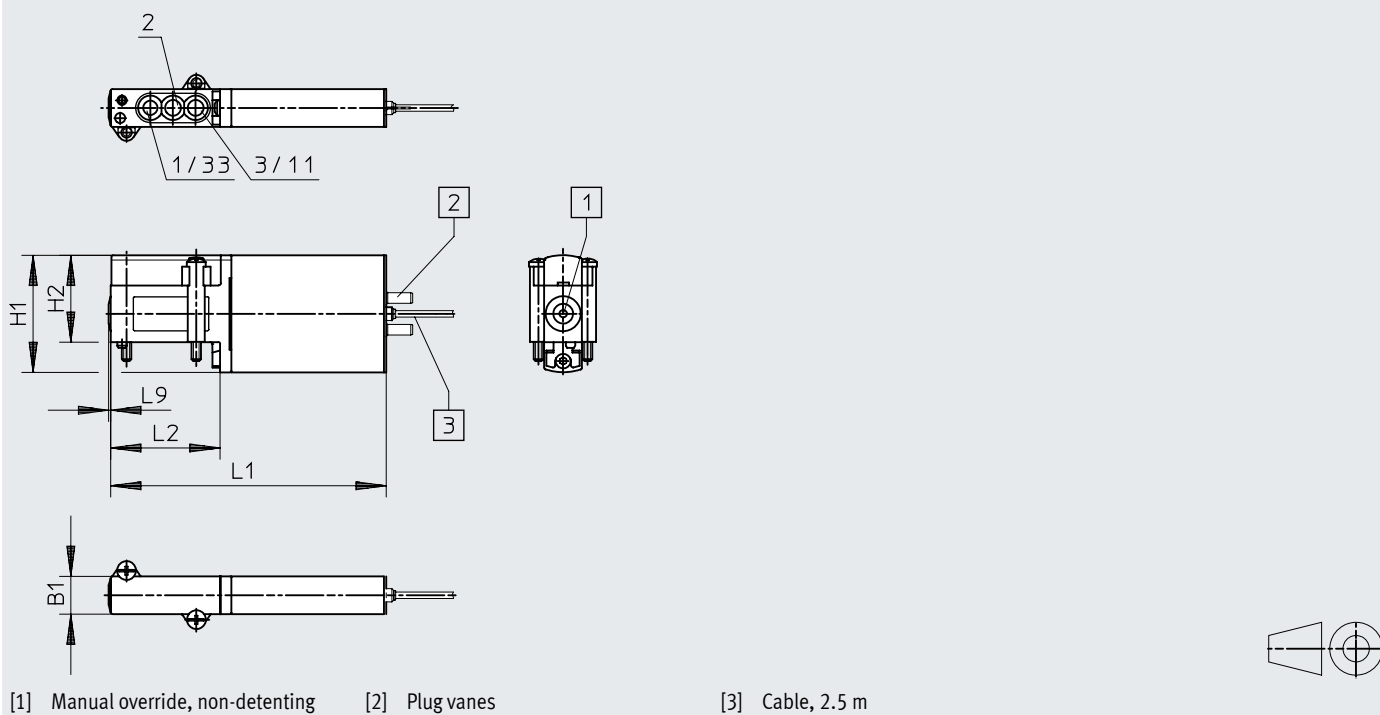

Hole pattern on sub-bases

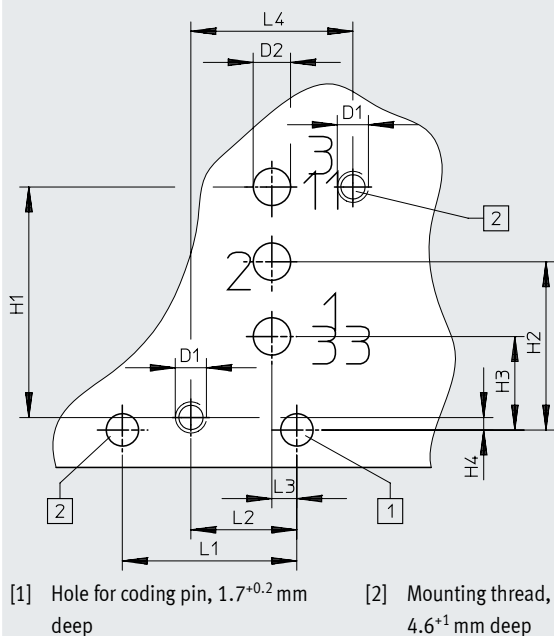

Type	B1	D1	D2 ∅	H1	H2	H3	H4	L1	L2	L3	L4	L9
MHA2-...-3/2...	10	-	-	31	23	-	-	73	29	-	-	0.5
Hole pattern	-	M2.5	3	18.5	13.5	7.5	1	14	8.5	2	13	-

Datasheet – Sub-base valve, 3/2-way valve

Dimensions

Download CAD data → www.festo.com

Individual sub-base, MHA2-AS-3-M5

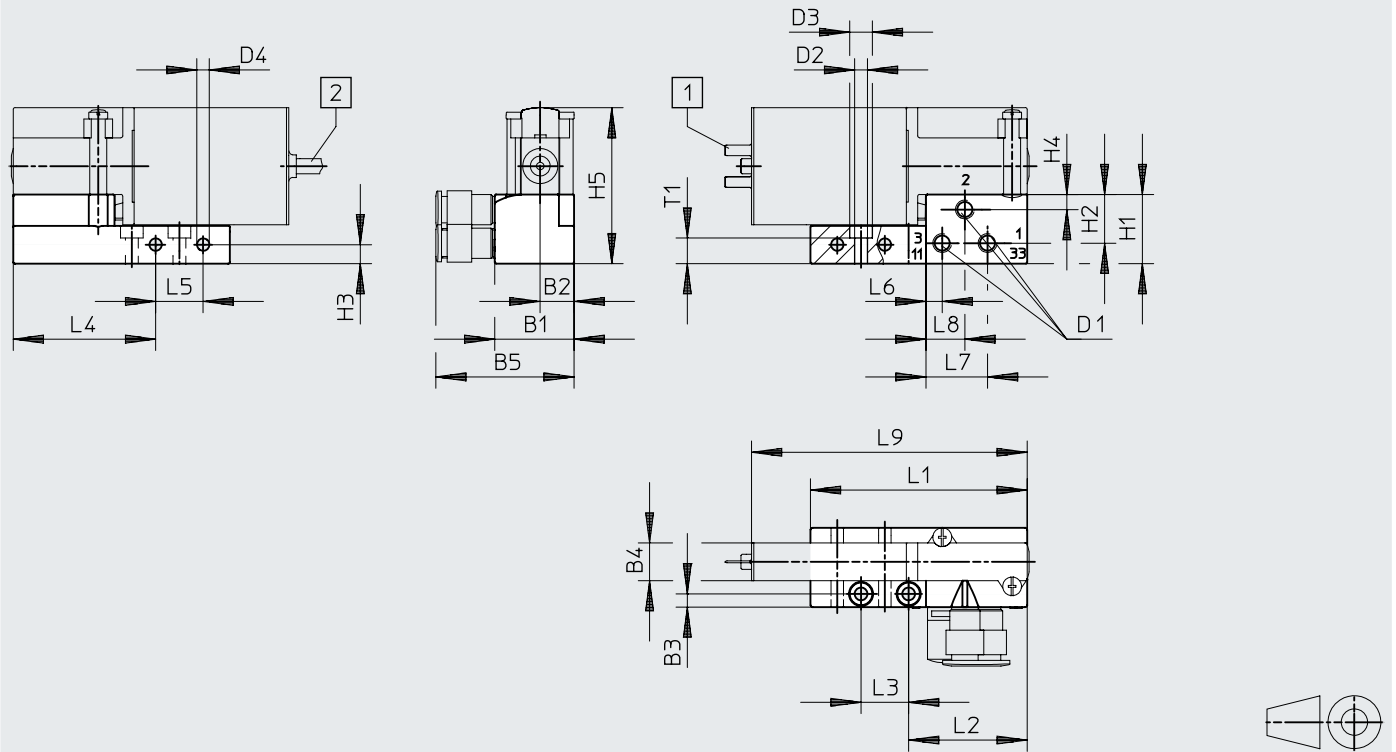

[1] Plug vanes

[2] Cable, 2.5 m

H-rail mounting MHAP2-BG-NRH-35

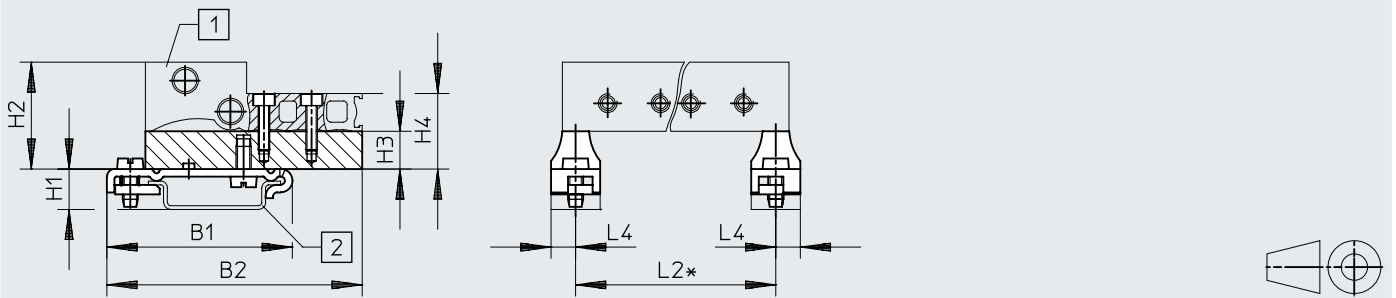

[1] Manifold block

[2] DIN mounting rail

* See dimensions table for manifold block used

Type	B1	B2	B3	B4	B5	D1	D2 ∅	D3 ∅	D4 ∅	H1	H2	H3	H4	H5
MHA2-AS-3-M5	21	9	3.5	10	36.6	M5	3.4	6	3.3	18.3	12.9	5	4	41.3
MHAP2-BG-NRH-35	49.1	67.6	-	-	-	-	-	-	-	10.7	28.3	10	20	20

Type	L1	L2	L3	L4	L5	L6	L7	L8	L9	T1
MHA2-AS-3-M5	57.4	31.4	12.6	37.7	12.6	4.3	16.3	10.3	73	6.8
MHAP2-BG-NRH-35	-	*	-	6.5	-	-	-	-	-	-

* See dimensions table for manifold block used

Datasheet – Sub-base valve, 3/2-way valve

Dimensions

Download CAD data → www.festo.com

Manifold assembly, MHA2-PR...-3-M5

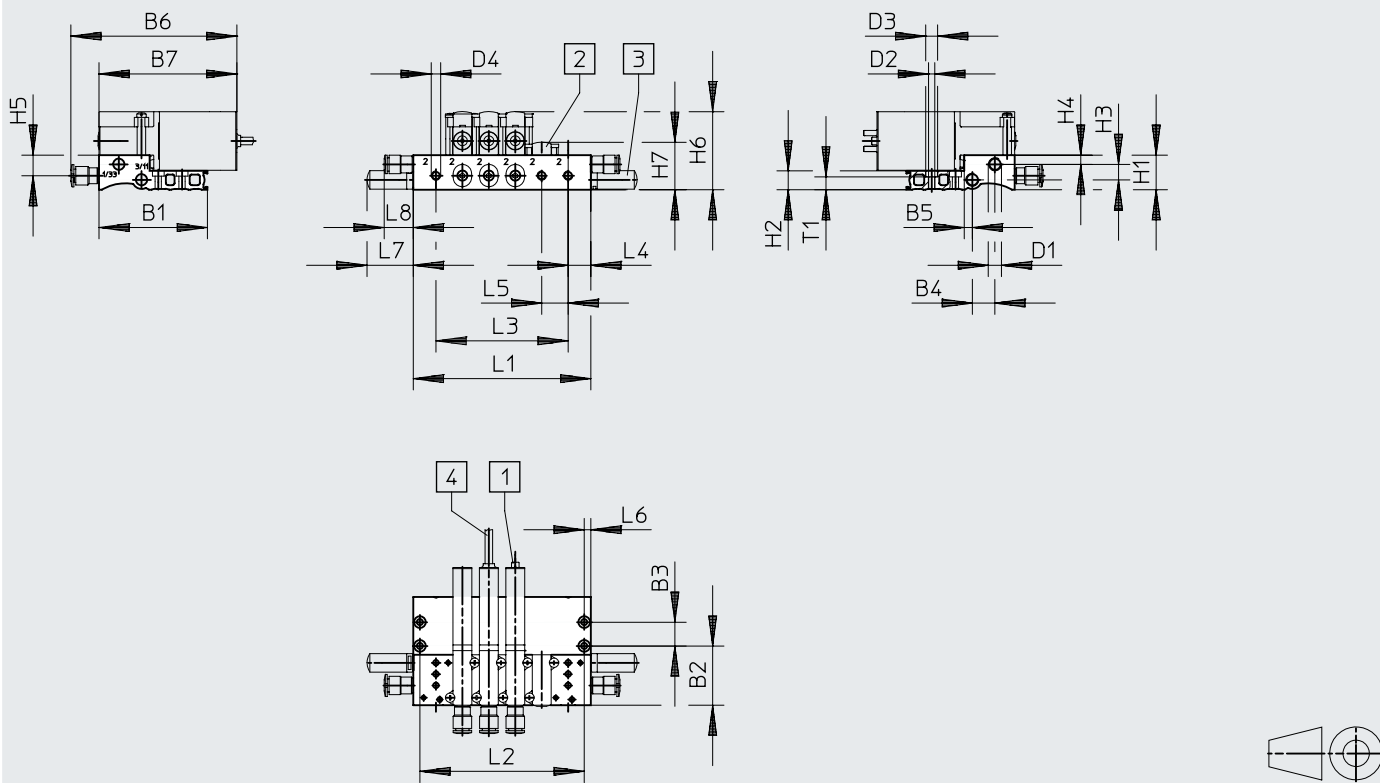

[1] Plug vanes

[2] Cover plate

[3] Silencer

[4] Cable, 2.5 m

Type	B1	B2	B3	B4	B5	B6	B7	D1	D2	D3	D4	H1	H2	H3	H4	H5	H6	H7
MHP2-PR...-3-M5	57.4	31.4	12.6	12	4.3	87.9	73	M7	3.3	6.3	M5	18.3	10	8.2	4.9	10.9	41.3	25.1





Type	L4	L5	L6	L7	L8	T1
MHP2-PR...-3-M5	12	14	3.5	24.5	15.4	6.8

Type		Number of valve positions				
		2	4	6	8	10
MHP2-PR...-3-M5	L1	38	66	94	122	150
	L2	31	59	87	115	143
	L3	14	42	70	98	126

 **Note**

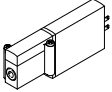
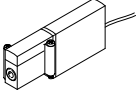
Valve types 3/2G and 3/2O must not be mixed on one manifold block.

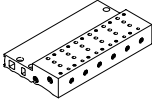

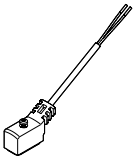
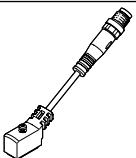





Datasheet – Sub-base valve, 3/2-way valve

Ordering data				Part no.	Type	
Valves						
	Electrical connection: 2-pin plug	With fast-switching electronics, switching time 2 ms	Normally open	196139	MHA2-MS1H-3/20-2	
			Normally closed	196119	MHA2-MS1H-3/2G-2	
		Without fast-switching electronics, switching time 7 ms	Normally open	196138	MHA2-M1H-3/20-2	
			Normally closed	196118	MHA2-M1H-3/2G-2	
	Electrical connection: cable	With fast-switching electronics, switching time 2 ms	Normally open	196141	MHA2-MS1H-3/20-2-K	
			Normally closed	196121	MHA2-MS1H-3/2G-2-K	
		Without fast-switching electronics, switching time 7 ms	Normally open	196140	MHA2-M1H-3/20-2-K	
			Normally closed	196120	MHA2-M1H-3/2G-2-K	
Manifold rail						
	Individual sub-base Pneumatic connection: thread M5		1 valve position	197438	MHA2-AS-3-M5	
	Manifold block Pneumatic connection 1, 11, 3, 33: thread M7 Pneumatic connection 2: thread M5		2 valve positions	197447	MHA2-PR2-3-M5	
			4 valve positions	197448	MHA2-PR4-3-M5	
			6 valve positions	197449	MHA2-PR6-3-M5	
			8 valve positions	197450	MHA2-PR8-3-M5	
			10 valve positions	197451	MHA2-PR10-3-M5	
Cover plate						
	Vacant valve positions must be sealed with a cover plate.			197470	MHAP2-BP-3	
Connecting cable (for valves with 2-pin plug)				Datasheets → Internet: nebv		
	2-pin socket, open cable end 2-wire	PUR cable, degree of protection IP65	Signal status indication with LED	Length 2.5 m	8047671	NEBV-Z4WA2L-P-E-2.5-N-LE2-S1
				Length 5 m	8047672	NEBV-Z4WA2L-P-E-5-N-LE2-S1
				Length 10 m	8047670	NEBV-Z4WA2L-P-E-10-N-LE2-S1
		PVC cable, degree of protection IP40	Without signal status indication	Length 0.5 m	193690	KMYZ-4-24-0.5-B
				Length 2.5 m	193691	KMYZ-4-24-2.5-B
	2-pin socket, plug M8x1 3-pin	PUR cable, degree of protection IP65	Signal status indication with LED	Length 0.5 m	8047673	NEBV-Z4WA2L-P-E-0.5-N-M8G3-S1
				Length 2.5 m	8047674	NEBV-Z4WA2L-P-E-2.5-N-M8G3-S1

 **Note**

Valve types 3/2G and 3/2O must not be mixed on one manifold block.

Datasheet – Sub-base valve, 3/2-way valve

Ordering data				Part no.	Type
Adapter (for valves with 2-pin plug)					
	2-pin socket	Signal status indication with LED	Plug M8, 3-pin	571686	VAVE-C8-1R8
			Plug M8, 4-pin	573194	VAVE-C8-1R1
H-rail mounting					
	For 3/2-way solenoid valves			525053	MHAP2-BG-NRH-35
H-rail					
	To EN 60715		2 m	35430	NRH-35-2000
Silencer Datasheets → Internet: uc					
	With threaded connection	M5	1 piece	165003	UC-M5
			50 pieces	534217	UC-M5-50
		M7	1 piece	161418	UC-M7
			50 pieces	534218	UC-M7-50
Push-in fitting Datasheets → Internet: qs					
	Male thread M5 with internal hex for tubing O.D.	4 mm	10 pieces	153315	QSM-M5-4-I
		6 mm	10 pieces	153317	QSM-M5-6-I
	Male thread M7 with internal hex for tubing O.D.	4 mm	10 pieces	153319	QSM-M7-4-I
		6 mm	10 pieces	153321	QSM-M7-6-I
	Male thread M5 with external hex, push-in L-fitting rotatable through 360°, for tubing O.D.	4 mm	10 pieces	153333	QSML-M5-4
		6 mm	10 pieces	153335	QSML-M5-6
	Male thread M7 with external hex, push-in L-fitting rotatable through 360°, for tubing O.D.	4 mm	10 pieces	186352	QSML-M7-4
		6 mm	10 pieces	186353	QSML-M7-6
	Male thread M5 with external hex, push-in L-fitting rotatable through 360°, for tubing O.D.	4 mm	100 pieces	133006	QSM-M7-4-I-100
		6 mm	100 pieces	133006	QSM-M7-6-I-100
Male thread M7 with external hex, push-in L-fitting rotatable through 360°, for tubing O.D.	4 mm	100 pieces	130771	QSML-M5-4-100	
	6 mm	100 pieces	130772	QSML-M5-6-100	
Male thread M7 with external hex, push-in L-fitting rotatable through 360°, for tubing O.D.	4 mm	100 pieces	130773	QSML-M7-4-100	
	6 mm	100 pieces	130774	QSML-M7-6-100	
Blanking plug					
	For thread M5		10 pieces	3843	B-M5
	For thread M7		10 pieces	174309	B-M7
Inscription label					
	For solenoid valve		80 pieces in a frame	197259	MH-BZ-80X

Peripherals overview – Sub-base valve, 5/2-way valve

Connection with plug vanes – Connection with moulded-in cable

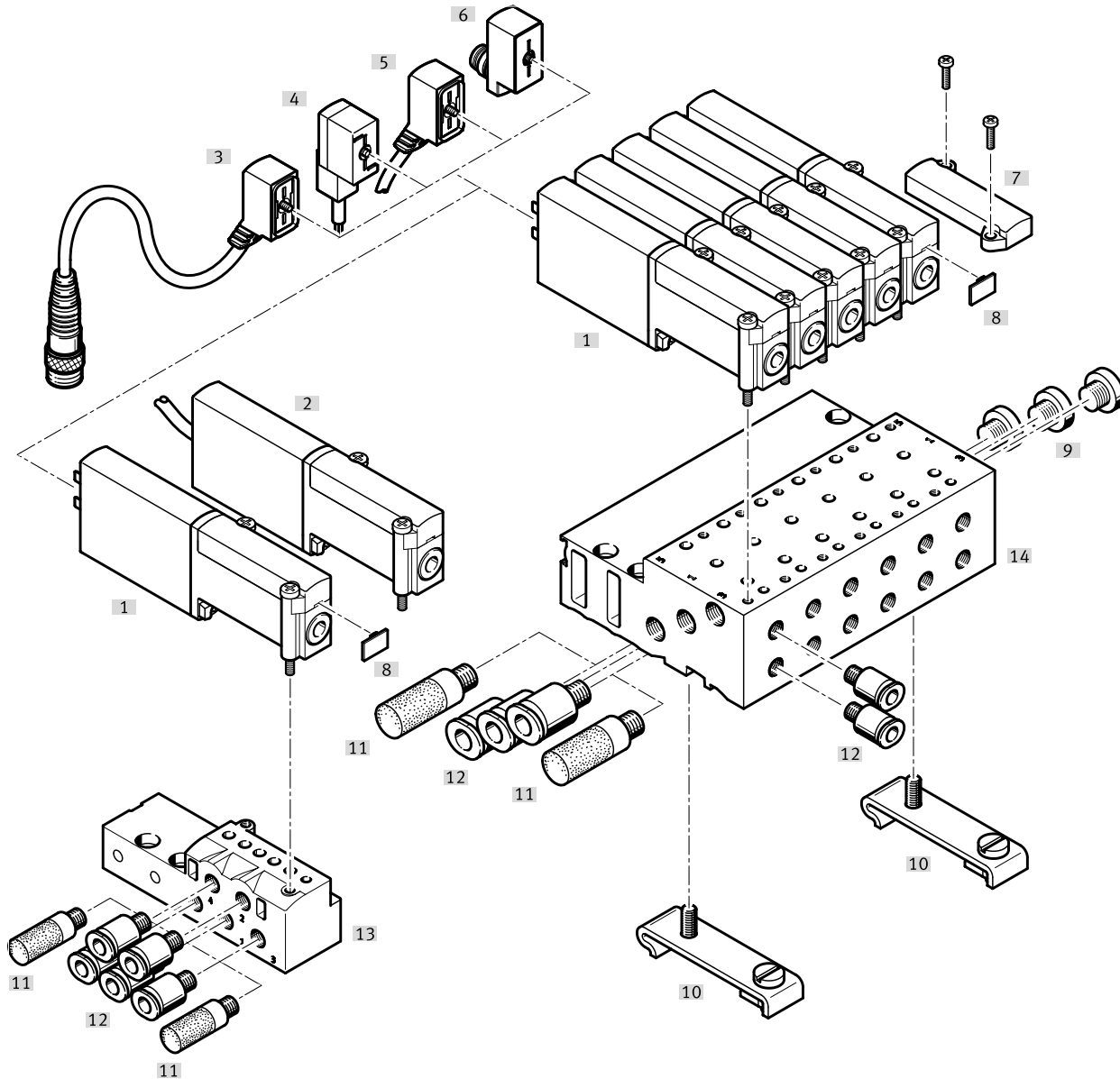



Designation	Type	Description	→ Page/Internet
[1] Sub-base valve	MHA2	With plug vanes	56
[2] Sub-base valve	MHA2-...-K	With moulded-in cable, IP55	56
[3] Connecting cable	NEBV	PUR cable, signal status indication with LED, plug M8x1 3-pin, IP65	56
[4] Plug socket with cable	KMYZ-4	PVC cable, without signal status indication, IP50	56
[5] Connecting cable	NEBV	PUR cable, signal status indication with LED, IP65	56
[6] Adapter	VAVE-C8	For connecting the valves via connecting cable M8 3-pin or 4-pin, IP65	57
[7] Cover plate	MHAP2-BP-5	For sealing vacant positions	56
[8] Inscription label	MH-BZ-80X	For identifying the valves	57
[9] Blanking plug	B	For sealing unused ports	57
[10] H-rail mounting	CPV10/14-VI-BG-NRH-35	For mounting the manifold block on H-rails to EN 60715	57
[11] Silencer	UC	For fitting in exhaust ports	57
[12] Push-in fittings	QS	For connecting compressed air tubing with standard O.D.	57
[13] Individual sub-base	MHA2-AS-5-M5	For sub-base valve	56
[14] Manifold block	MHA2-PR...-5-M5	For sub-base valve	56

Datasheet – Sub-base valve, 5/2-way valve

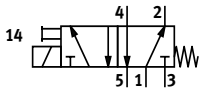
Function



-  - Voltage
24 V DC
-  - Pressure
-0.09 ... +0.8 MPa
-  - Temperature range
-5 ... +40°C



General technical data		
Valve function		5/2-way, single solenoid
Design		Pressure relief poppet valve
Overlap		Negative overlap
Sealing principle		Soft
Reset method		Mechanical spring
Actuation type		Electrical
Type of control		Direct
Direction of flow		Not reversible
Exhaust function		Can be throttled
Manual override		Non-detenting
Mounting position		Any
Width	[mm]	10
Grid dimension	[mm]	14
Note on grid dimension		Minimum distance between the valves is 4 mm
Nominal width	[mm]	2
Standard nominal flow rate	[l/min]	90
Type of mounting		On PR rail
Max. tightening torque for valve mounting	[Nm]	0.4
Pneumatic connection		Sub-base
Product weight	[g]	70

Datasheet – Sub-base valve, 5/2-way valve

Operating and environmental conditions		
Operating medium		Compressed air to ISO 8573-1:2010 [7:4:4]
Note on the operating/pilot medium		Lubricated operation possible (in which case lubricated operation will always be required)
Operating pressure	[MPa]	-0.09 ... +0.8
	[bar]	-0.9 ... +8
Ambient temperature	[°C]	-5 ... +40
Temperature of medium	[°C]	-5 ... +40
Restricted ambient temperature and temperature of medium		As a function of switching frequency (see graph)
Corrosion resistance class CRC ¹⁾		2
CE marking (see declaration of conformity) ³⁾		To EU EMC Directive ²⁾
		To EU RoHS Directive
UKCA marking (see declaration of conformity) ³⁾		To UK instructions for EMC
		To UK RoHS instructions
Certification		c UL us - Recognized (OL)
		RCM
Cleanroom class		Class 6 to ISO 14644-1
Shock resistance		Shock test with severity level 2 to FN 942017-5 and EN 60068-2-27
Vibration resistance		Transport application test with severity level 2 to FN 942017-4 and EN 60068-2-6

1) More information: www.festo.com/x/topic/kbk

2) For information about the area of use, see the EC declaration of conformity at: www.festo.com/catalogue/mh2 → Support/Downloads.

If the devices are subject to usage restrictions in residential, commercial or light-industrial environments, further measures for the reduction of the emitted interference may be necessary.

3) More information: www.festo.com/catalogue/... → Support/Downloads.

Electrical data		
Electrical connection		2-pin plug Cable
Operating voltage	[V DC]	24
Permissible voltage fluctuations	[%]	±10
Power consumption	Low-current phase	[W] 1.625
	High-current phase	[W] 6.5
Reverse polarity protection		Bipolar
Duty cycle	[%]	100
Additional functions		Spark arresting
		Holding current reduction
		Protective circuit
Degree of protection to EN 60529		IP65 IP55

Switching times and frequencies		
Switching time	On	[ms] 1.9
	Off	[ms] 1.7
Tolerance for switching time	On	[%] +10 ... -30
	Off	[%] +10 ... -30
Maximum switching frequency		[Hz] 300
Switching time variation from 1 Hz upwards		[ms] 0.2

Materials	
Housing	Coated die-cast zinc
Cable sheath	PUR
Seals	HNBR, NBR
Screws	Galvanised steel
Note on materials	RoHS-compliant
PWIS conformity	VDMA24364-B1/B2-L

Datasheet – Sub-base valve, 5/2-way valve

Restricted ambient temperature and temperature of medium as a function of switching frequency

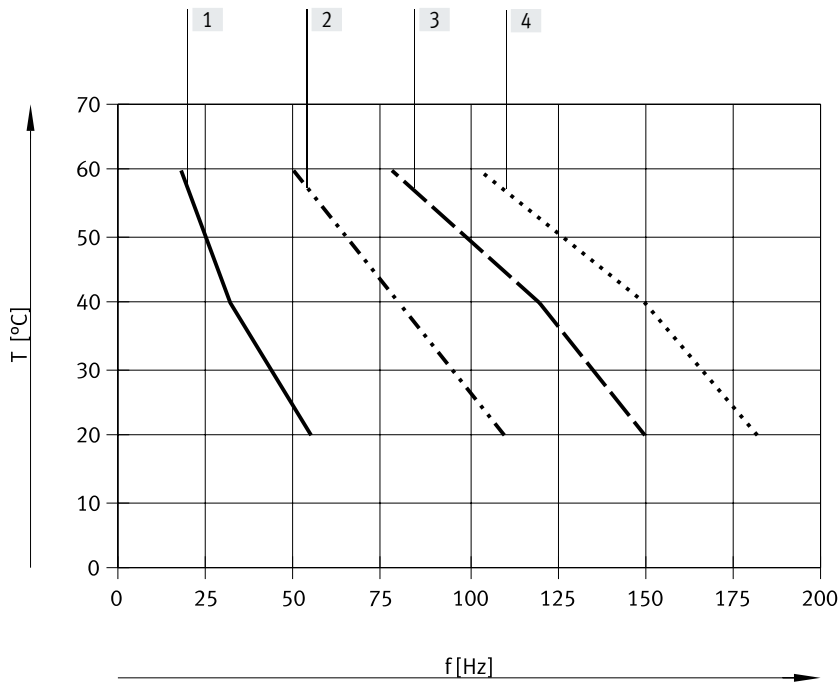

- [1] Valve manifold assembly, 6 valves, unpressurised
- [2] Valve manifold assembly, 6 valves, through-flow, 0.6 MPa
- [3] Individual valve, unpressurised
- [4] Individual valve, through-flow, 0.6 MPa

Current curve for valves with fast-switching electronics (MHA2-MS1H)

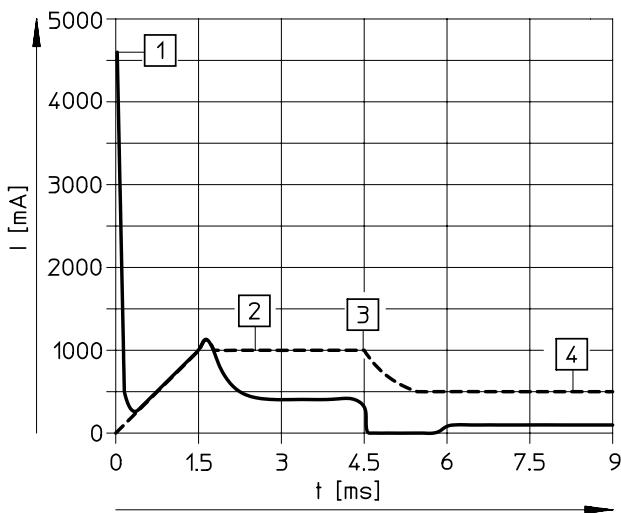

- [1] Capacitor charging
- [2] Controlled coil current 1 A
- [3] Holding current reduction
- [4] Controlled holding current 0.5 A

..... Internal current in the coil
 — External current in the supply line

Datasheet – Sub-base valve, 5/2-way valve

Dimensions

Download CAD data → www.festo.com

Valve with plug vanes or moulded-in cable, MHA2-...-5/2...

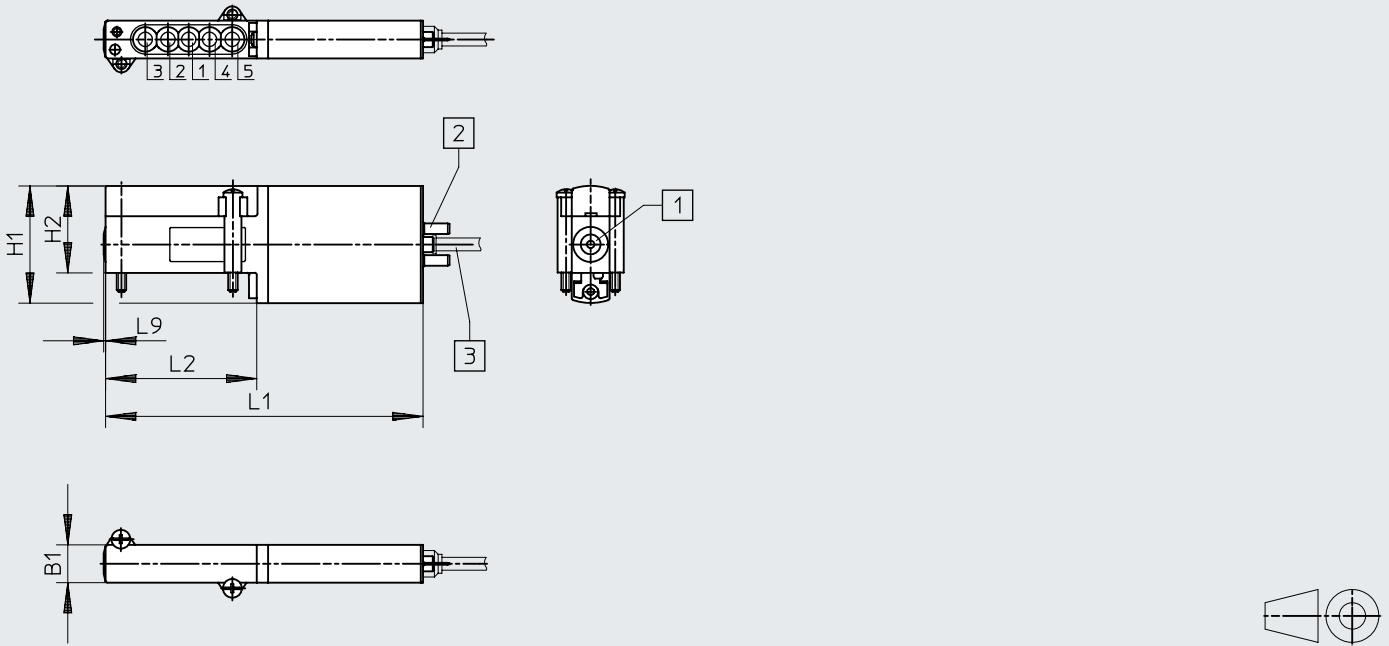

[1] Manual override, non-detenting [2] Plug vanes [3] Cable, 2.5 m

Hole pattern on sub-bases

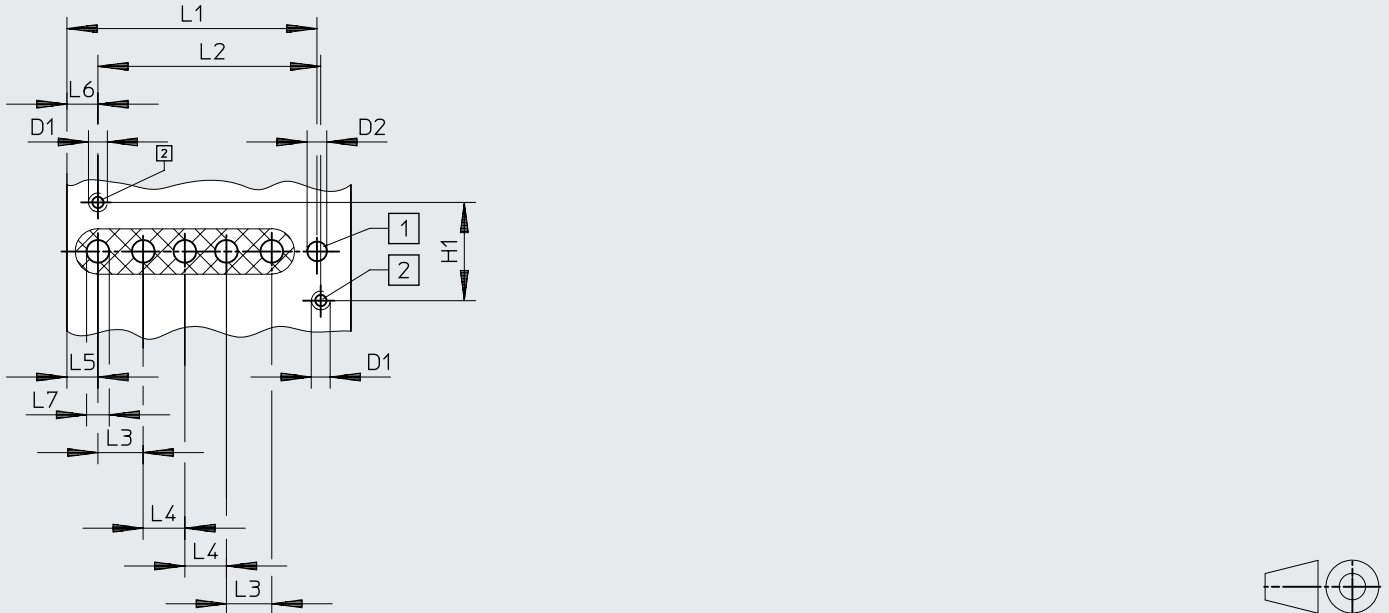

[1] Hole for coding pin, 1.7^{+0.2} mm deep [2] Mounting thread, 4.6⁺¹ mm deep

Type	B1	D1	D2 ∅	H1	H2	L1	L2	L3	L4	L5	L6	L7	L9
MHA2-...-5/2...	10	-	-	31	23	84	40	-	-	-	-	-	0.5
Hole pattern	-	M2.5	2.6	13	-	33.1	29.5	6	5.5	4.1	4.1	3	-

Datasheet – Sub-base valve, 5/2-way valves

Dimensions

Download CAD data → www.festo.com

Individual sub-base, MHA2-AS-5-M5

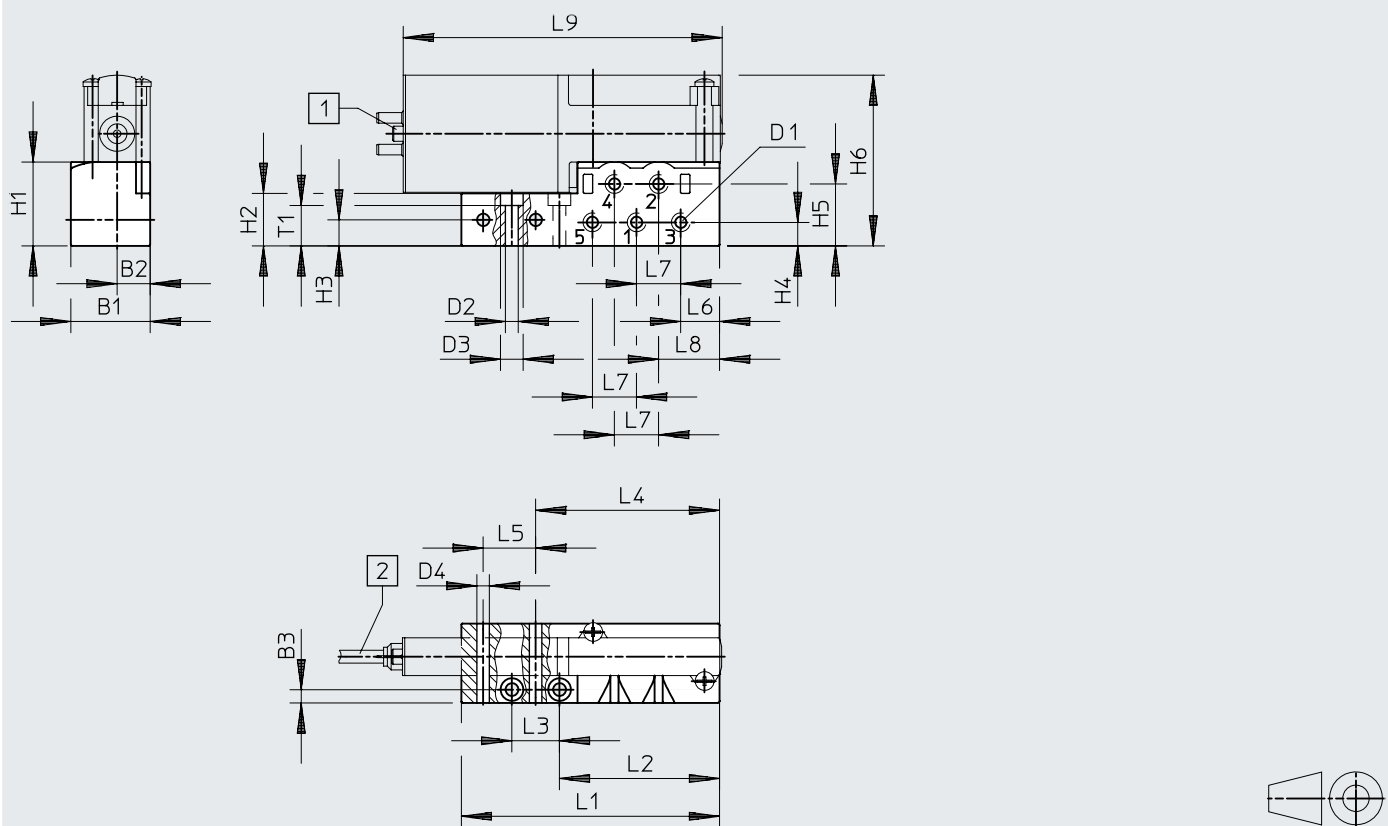

[1] Plug vanes

[2] Cable, 2.5 m

Type	B1	B2	B3	D1	D2 ∅	D3 ∅	D4 ∅	H1	H2	H3	H4	H5	H6
MHA2-AS-5-M5	21	8.8	3.5	M5	3.4	6	3.3	22.2	13.9	6.9	6.2	16.4	45.2

Type	L1	L2	L3	L4	L5	L6	L7	L8	L9	T1
MHA2-AS-5-M5	68.4	42.4	12.6	48.7	13.9	10.3	11.7	16.2	84.5	10.7

Datasheet – Sub-base valve, 5/2-way valves

Dimensions

Download CAD data → www.festo.com

Manifold assembly, MHA2-PR...-5-M5

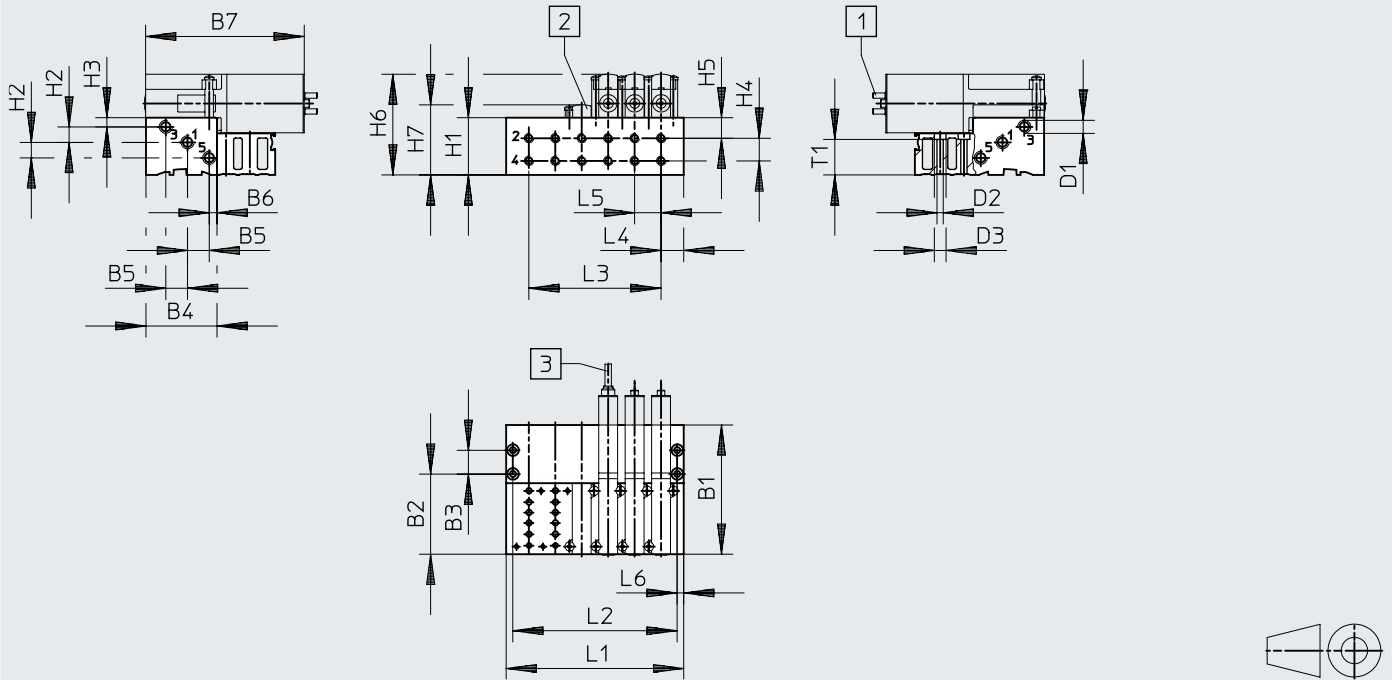

[1] Plug vanes





[2] Cover plate

[3] Cable, 2.5 m



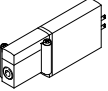
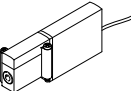

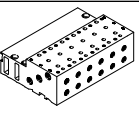

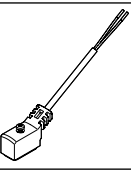
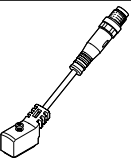
Type	B1	B2	B3	B4	B5	B6	B7	D1	D2 ∅	D3 ∅	H1	H2	H3	H4	H5	H6	H7	L4	L5	L6	T1
MHA2-PR...-5-M5	68.4	42.4	12.6	37.6	11.5	4.1	84	M7	3.3	6.3	30.3	8.2	4.9	12	10.9	53.3	37.1	12	14	3.5	18.8

Type		Number of valve positions				
		2	4	6	8	10
MHA2-PR...-5-M5	L1	38	66	94	122	150
	L2	31	59	87	115	143
	L3	14	42	70	98	126

Datasheet – Sub-base valve, 5/2-way valve

Ordering data				Part no.	Type	
Valves						
	Electrical connection: plug vanes	With fast-switching electronics, switching time 2 ms		525101	MHA2-MS1H-5/2-2	
	Electrical connection: cable	With fast-switching electronics, switching time 2 ms		525103	MHA2-MS1H-5/2-2-K	
Manifold rail						
	Individual sub-base Pneumatic connection: thread M5	1 valve position	525120	MHA2-AS-5-M5		
	Manifold block Pneumatic connection 1, 3, 5: thread M7 Pneumatic connection 2, 4: thread M5	2 valve positions	525127	MHA2-PR2-5-M5		
		4 valve positions	525128	MHA2-PR4-5-M5		
		6 valve positions	525129	MHA2-PR6-5-M5		
		8 valve positions	525130	MHA2-PR8-5-M5		
		10 valve positions	525131	MHA2-PR10-5-M5		
Cover plate						
	Vacant valve positions must be sealed with a cover plate.			525132	MHAP2-BP-5	
Connecting cable (for valves with 2-pin plug) Datasheets → Internet: nebv						
	2-pin socket, open cable end 2-wire	PUR cable, degree of protection IP65	Signal status indication with LED	Length 2.5 m	8047671	NEBV-Z4WA2L-P-E-2.5-N-LE2-S1
				Length 5 m	8047672	NEBV-Z4WA2L-P-E-5-N-LE2-S1
				Length 10 m	8047670	NEBV-Z4WA2L-P-E-10-N-LE2-S1
		PVC cable, degree of protection IP40	Without signal status indication	Length 0.5 m	193690	KMYZ-4-24-0.5-B
				Length 2.5 m	193691	KMYZ-4-24-2.5-B
	2-pin socket, plug M8x1 3-pin	PUR cable, degree of protection IP65	Signal status indication with LED	Length 0.5 m	8047673	NEBV-Z4WA2L-P-E-0.5-N-M8G3-S1
				Length 2.5 m	8047674	NEBV-Z4WA2L-P-E-2.5-N-M8G3-S1

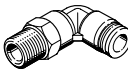
Datasheet – Sub-base valve, 5/2-way valve

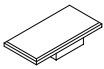
Ordering data				Part no.	Type
Adapter (for valves with 2-pin plug)					
	2-pin socket	Signal status indication with LED	Plug M8, 3-pin	571686	VAVE-C8-1R8
			Plug M8, 4-pin	573194	VAVE-C8-1R1
H-rail mounting					
	For 5/2-way solenoid valves			162556	CPV10/14-VI-BG-NRH-35
H-rail					
	To EN 60715	2 m	35430	NRH-35-2000	
Silencer Datasheets → Internet: uc					
	With threaded connection	M5	1 piece	165003	UC-M5
			50 pieces	534217	UC-M5-50
		M7	1 piece	161418	UC-M7
			50 pieces	534218	UC-M7-50
Push-in fitting Datasheets → Internet: qs					
	Male thread M5 with internal hex for tubing O.D.	4 mm	10 pieces	153315	QSM-M5-4-I
		6 mm	10 pieces	153317	QSM-M5-6-I
	Male thread M7 with internal hex for tubing O.D.	4 mm	10 pieces	153319	QSM-M7-4-I
		6 mm	10 pieces	153321	QSM-M7-6-I
	Male thread M5 with external hex, push-in L-fitting rotatable through 360°, for tubing O.D.	4 mm	10 pieces	153333	QSML-M5-4
		6 mm	10 pieces	153335	QSML-M5-6
	Male thread M5 with external hex, push-in L-fitting rotatable through 360°, for tubing O.D.	100 pieces	130771	QSML-M5-4-100	
		100 pieces	130772	QSML-M5-6-100	
	Male thread M7 with external hex, push-in L-fitting rotatable through 360°, for tubing O.D.	4 mm	10 pieces	186352	QSML-M7-4
		6 mm	10 pieces	186353	QSML-M7-6
100 pieces	130773	QSML-M7-4-100			
100 pieces	130774	QSML-M7-6-100			
Blanking plug					
	For thread M5	10 pieces	3843	B-M5	
	For thread M7	10 pieces	174309	B-M7	
Inscription label					
	For solenoid valve	80 pieces in a frame	197259	MH-BZ-80X	

Peripherals overview – Individual valve

Connection with plug vanes – Connection with moulded-in cable

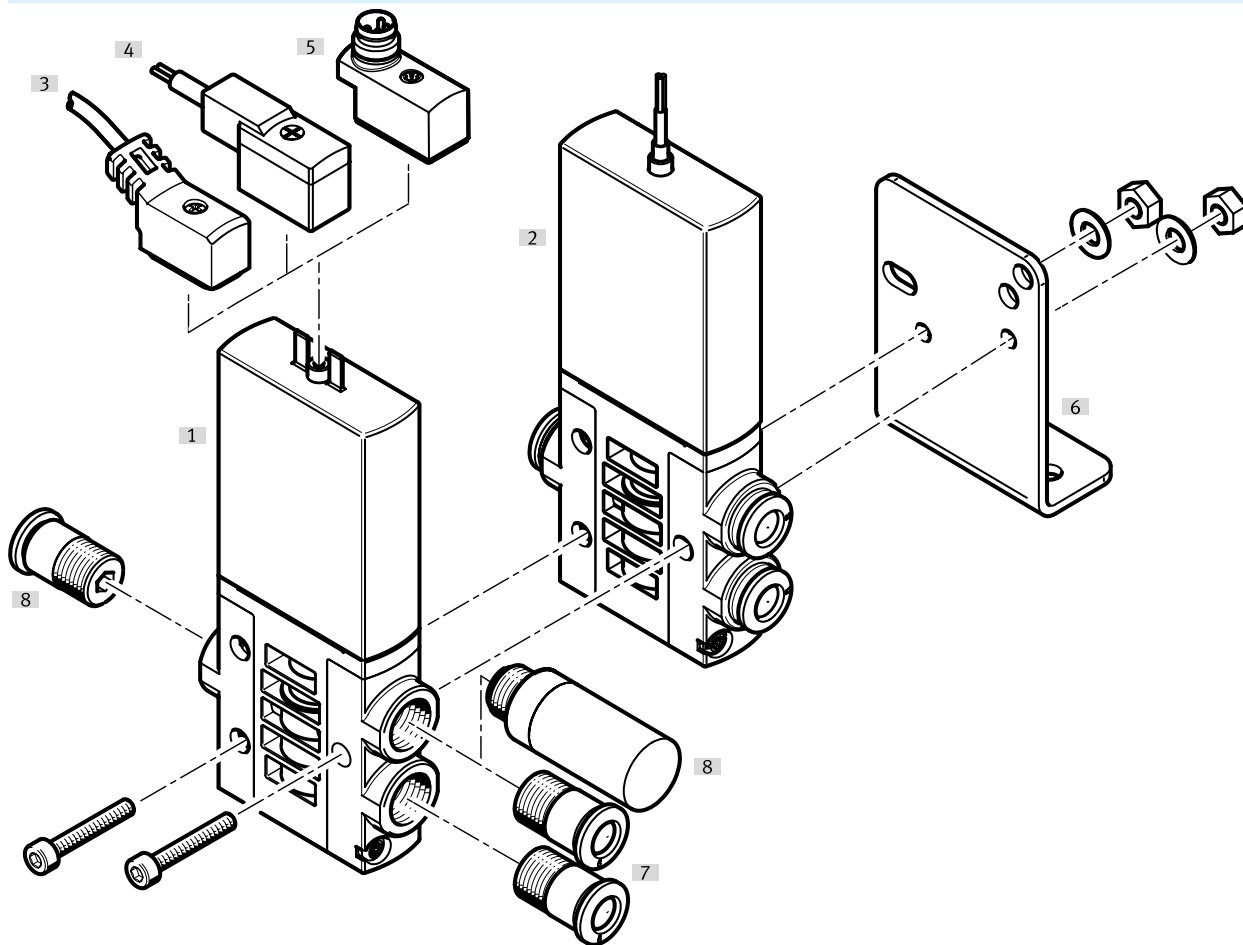



Designation	Type	Description	→ Page/Internet
[1] Individual valve	MHE3	With plug vanes	64
[2] Individual valve	MHE3-...-K	With moulded-in cable, IP65	64
[3] Connecting cable	NEBV	PUR cable, signal status indication with LED, IP65	65
[4] Plug socket with cable	KMYZ-4	PVC cable, without signal status indication, IP50	65
[5] Adapter	VAVE-C8	For connecting the valves via connecting cable M8 3-pin or 4-pin, IP65	65
[6] Mounting bracket	MHE2-BG-L	For wall mounting	65
[7] Push-in fittings	QS	For connecting compressed air tubing with standard O.D.	65
[8] Silencer	UC	For fitting in exhaust ports	65

Datasheet – Individual valve

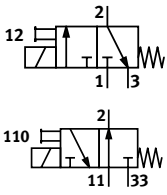
Function



-  - Voltage
24 V DC
-  - Pressure
-0.09 ... +0.8 MPa
-  - Temperature range
-5 ... +60°C



General technical data

Valve function	3/2 way, single solenoid ¹⁾
Design	Pressure relief poppet valve
Overlap	Negative overlap
Sealing principle	Soft
Reset method	Mechanical spring
Actuation type	Electrical
Type of control	Direct
Direction of flow	Reversible with restrictions ²⁾
Exhaust function	Can be throttled
Manual override	Non-detenting
Mounting position	Any
Width	[mm] 14
Grid dimension	[mm] 19
Note on grid dimension	Minimum distance between the valves is 5 mm
Nominal width	[mm] 3
Standard nominal flow rate	[l/min] 200
Type of mounting	Via through-hole
Pneumatic connection	Connecting thread G1/8 Push-in connector for tubing O.D. 6 mm
Product weight	[g] 120

- 1) Can be used as a 2/2-way valve by sealing port 3 or 33
 2) Slight leakage can occur in the pressure range -0.8 bar to +0.5 bar.

Operating and environmental conditions

	With fast-switching electronics	Without fast-switching electronics
Operating medium	Compressed air to ISO 8573-1:2010 [7:4:4]	
Note on the operating/pilot medium	Lubricated operation possible (in which case lubricated operation will always be required)	
Ambient temperature	[°C] -5 ... +60	
Temperature of medium	[°C] -5 ... +60	
Restricted ambient temperature and temperature of medium	As a function of switching frequency	-
Corrosion resistance class CRC ¹⁾	2	2
CE marking (see declaration of conformity) ³⁾	To EU EMC Directive ²⁾	-
	To EU RoHS Directive	-
UKCA marking (see declaration of conformity) ³⁾	To UK instructions for EMC	-
	To UK RoHS instructions	-
Certification	c UL us - Recognized (OL) RCM	c UL us - Recognized (OL) -
Cleanroom class	Class 6 to ISO 14644-1	
Shock resistance	Shock test with severity level 2 to FN 942017-5 and EN 60068-2-27	
Vibration resistance	Transport application test with severity level 2 to FN 942017-4 and EN 60068-2-6	

- 1) More information: www.festo.com/x/topic/kbk
 2) For information about the area of use, see the EC declaration of conformity at: www.festo.com/catalogue/mh2 → Support/Downloads.
 If the devices are subject to usage restrictions in residential, commercial or light-industrial environments, further measures for the reduction of the emitted interference may be necessary.
 3) More information: www.festo.com/catalogue/... → Support/Downloads.

Datasheet – Individual valve

Operating and environmental conditions		With fast-switching electronics	Without fast-switching electronics
Operating pressure		[MPa]	-0.09 ... +0.8
		[bar]	-0.9 ... +8
	Reversible	[MPa]	-0.09 ... +0.1
		[bar]	-0.9 ... +1
		[psi]	-13.05 ... +14.5
Operating pressure for • MHE3-M1H-3/20-1/8-K • MHE3-M1H-3/20-QS-6 • MHE3-MS1H-3/20-1/8-K • MHE3-MS1H-3/20-QS-6		[MPa]	-0.09 ... +0.8
		[bar]	-0.9 ... +8
	Reversible	[MPa]	-0.09 ... +0.1
		[bar]	-0.9 ... +1
		[psi]	-13.05 ... +14.5

Electrical data		With fast-switching electronics	Without fast-switching electronics
Electrical connection		2-pin plug or cable	
Operating voltage	[V DC]	24	
Permissible voltage fluctuations	[%]	±10	
Power consumption	[W]	6.5 for approx. 4.5 ms (high-current phase, inrush current 1 A)	3.7
	[W]	1.6 (low-current phase)	-
Reverse polarity protection		Bipolar	-
Duty cycle	[%]	100	100
Additional functions		Spark arresting	-
		Holding current reduction	-
		Protective circuit	-
Degree of protection to EN 60529		IP65	IP65

Switching times and frequencies		With fast-switching electronics	Without fast-switching electronics
Switching time	On [ms]	2.3	8.3
	Off [ms]	2.8	4.5
Tolerance for switching time	On [%]	+10 ... -30	-
	Off [%]	+10 ... -50	-
Switching time variation from 1 Hz upwards	[ms]	0.2	-
Maximum switching frequency	[Hz]	280	130

Materials	
Housing	Coated die-cast zinc
Cable sheath	PUR
Seals	HNBR, NBR
Screws	Galvanised steel
Note on materials	RoHS-compliant
PWIS conformity	VDMA24364-B1/B2-L

Datasheet – Individual valve

Restricted ambient temperature and temperature of medium as a function of switching frequency

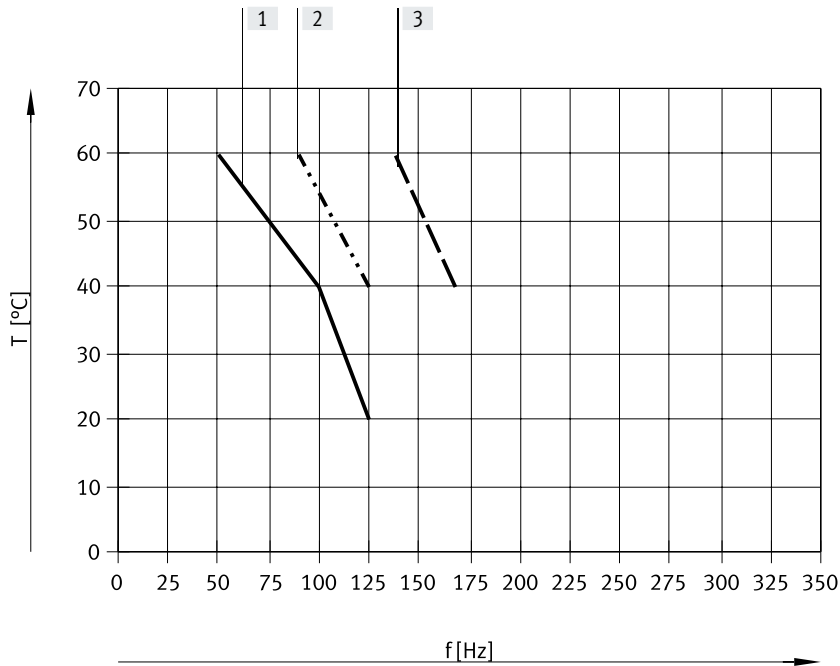

- [1] Valve manifold assembly, 6 valves, unpressurised
- [2] Valve manifold assembly, 6 valves, through-flow, 0.6 MPa
- [3] Individual valve, unpressurised

No restrictions for individual valve, through-flow, 0.6 MPa.

Current curve for valves with fast-switching electronics (MHE3-MS1H)

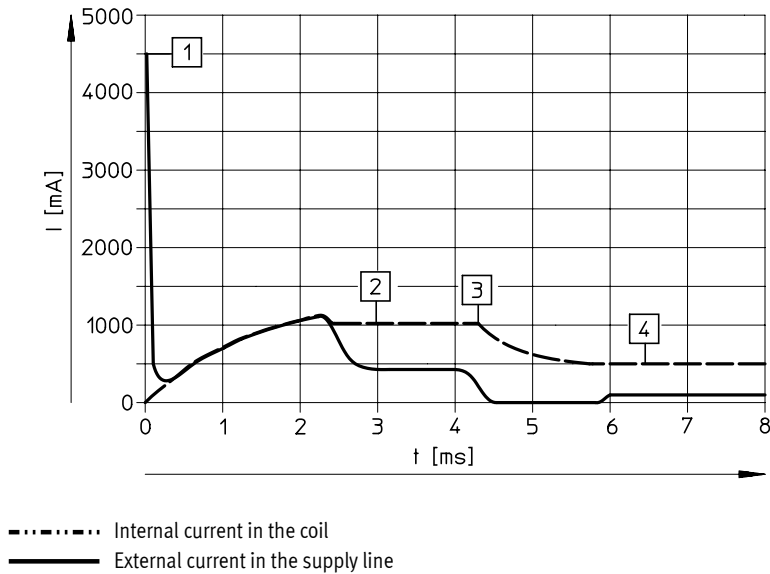

- [1] Capacitor charging
- [2] Controlled coil current 1 A
- [3] Holding current reduction
- [4] Controlled holding current 0.5 A

--- Internal current in the coil
 — External current in the supply line

Datasheet – Individual valve

Dimensions

Download CAD data → www.festo.com

Valve with plug vanes or moulded-in cable

MHE3-...-G1/8

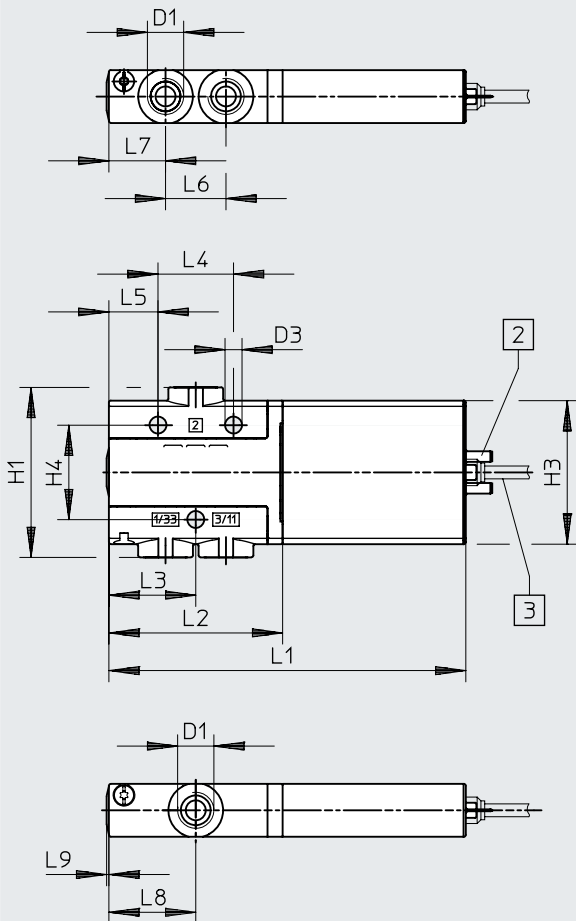

MHE3-...-QS6

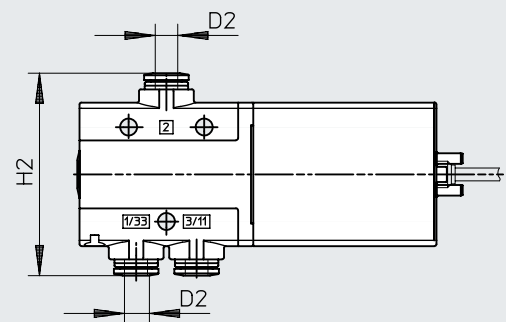

[1] Manual override, non-detenting

[2] Plug vanes

[3] Cable, 2.5 m

Type	B1	D1	D2 Ø	D3 Ø	H1	H2	H3	H4	L1	L2	L3	L4	L5	L6	L7	L8	L9
MHE3-...-1/8-...	14	G1/8	-	4.5	45	-	38	25	94.5	46	23	20	13	16	15	23	0.6
MHE3-...-QS-6-...	14	-	6	4.5	45	53.6	38	25	94.5	46	23	20	13	16	15	23	0.6

Datasheet – Individual valve

Dimensions

Download CAD data → www.festo.com

Mounting bracket MHE2-BG-L

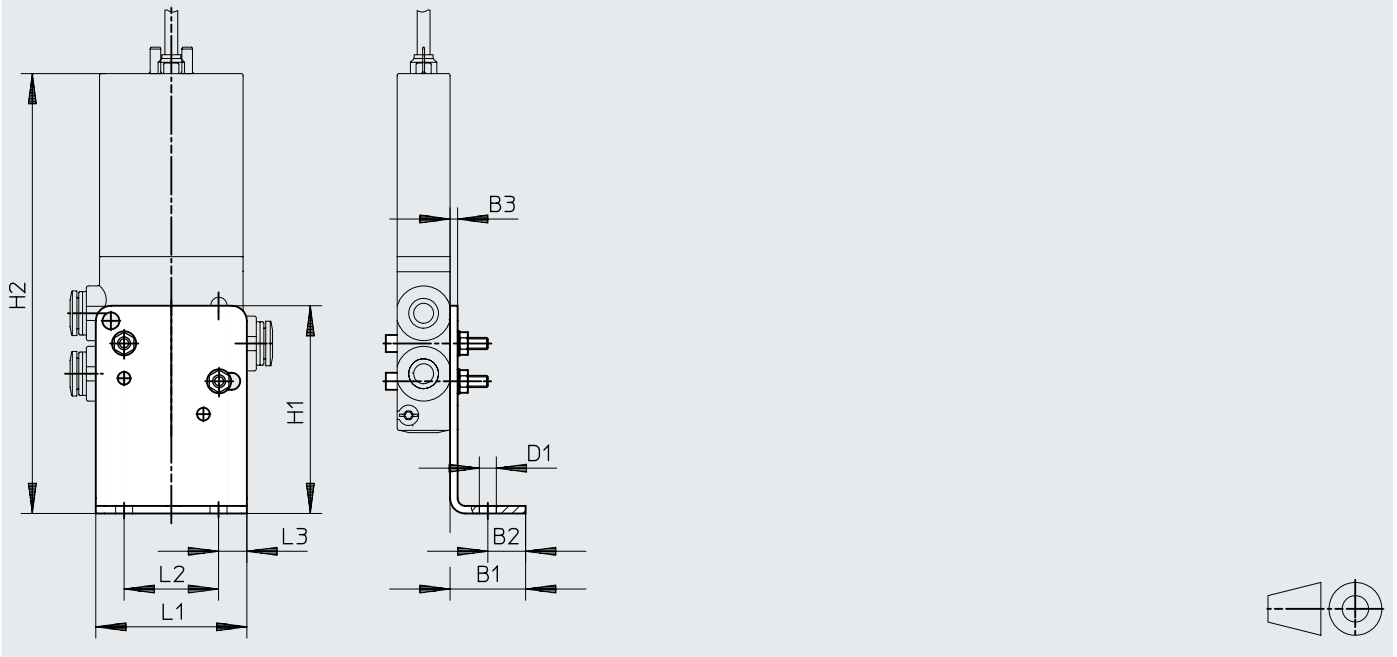



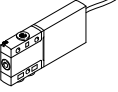

Type	B1	B2	B3	D1	H1	H2	L1	L2	L3
MHE2-BG-L	20	10	2	4.5	55	113.3	40	25	7.5

Datasheet – Individual valve

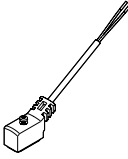
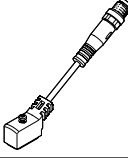
Ordering data					Part no.	Type		
Valves								
	Electrical connection: 2-pin plug	With fast-switching electronics, switching time 2.3 ms	Pneumatic connection: thread G1/8	Normally open	525167	MHE3-MS1H-3/20-1/8		
				Normally closed	525147	MHE3-MS1H-3/2G-1/8		
			Without fast-switching electronics, switching time 8.3 ms	Pneumatic connection: push-in connector for tubing O.D. 6 mm	Normally open	525171	MHE3-MS1H-3/20-QS-6	
				Normally closed	525151	MHE3-MS1H-3/2G-QS-6		
		Electrical connection: cable	With fast-switching electronics, switching time 2.3 ms	Pneumatic connection: thread G1/8	Normally open	525169	MHE3-MS1H-3/20-1/8-K	
					Normally closed	525149	MHE3-MS1H-3/2G-1/8-K	
				Without fast-switching electronics, switching time 8.3 ms	Pneumatic connection: push-in connector for tubing O.D. 6 mm	Normally closed	525153	MHE3-MS1H-3/2G-QS-6-K
					Pneumatic connection: thread G1/8	Normally open	525168	MHE3-M1H-3/20-1/8-K
			Normally closed	525148	MHE3-M1H-3/2G-1/8-K			
			Pneumatic connection: push-in connector for tubing O.D. 6 mm	Normally closed	525152	MHE3-M1H-3/2G-QS-6-K		

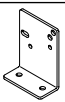
Datasheet – Individual valve

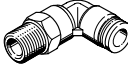
Ordering data					Part no.	Type
Connecting cable (for valves with 2-pin plug)					Datasheets → Internet: nebv	
	2-pin socket, open cable end 2-wire	PUR cable, degree of protection IP65	Signal status indication with LED	Length 2.5 m	8047671	NEBV-Z4WA2L-P-E-2.5-N-LE2-S1
				Length 5 m	8047672	NEBV-Z4WA2L-P-E-5-N-LE2-S1
		PVC cable, degree of protection IP40	Without signal status indication	Length 10 m	8047670	NEBV-Z4WA2L-P-E-10-N-LE2-S1
				Length 0.5 m	193690	KMYZ-4-24-0.5-B
	2-pin socket, plug M8x1 3-pin	PUR cable, degree of protection IP65	Signal status indication with LED	Length 0.5 m	8047673	NEBV-Z4WA2L-P-E-0.5-N-M8G3-S1
				Length 2.5 m	8047674	NEBV-Z4WA2L-P-E-2.5-N-M8G3-S1
Adapter (for valves with 2-pin plug)						
	2-pin socket	Signal status indication with LED	Plug M8, 3-pin	571686	VAVE-C8-1R8	
			Plug M8, 4-pin	573194	VAVE-C8-1R1	
Wall mounting						
	Mounting bracket			196165	MHE2-BG-L	
Silencer						
	Push-in sleeve with O.D. 6 mm			1 piece	165007	UC-QS-6H
	With threaded connection G1/8			1 piece	161419	UC-1/8
				50 pieces	534219	UC-1/8-50
Push-in fitting						
	Male thread G1/8 with external hex for tubing O.D.		6 mm	10 pieces	186096	QS-G1/8-6
				100 pieces	132037	QS-G1/8-6-100
			8 mm	10 pieces	186098	QS-G1/8-8
				50 pieces	132038	QS-G1/8-8-50
	Male thread G1/8 with external hex, push-in L-fitting rotatable through 360°, for tubing O.D.		6 mm	10 pieces	186117	QSL-G1/8-6
				100 pieces	132049	QSL-G1/8-6-100
			8 mm	10 pieces	186119	QSL-G1/8-8
				50 pieces	132050	QSL-G1/8-8-50

Peripherals overview – Semi in-line valve

Connection with plug vanes – Connection with moulded-in cable

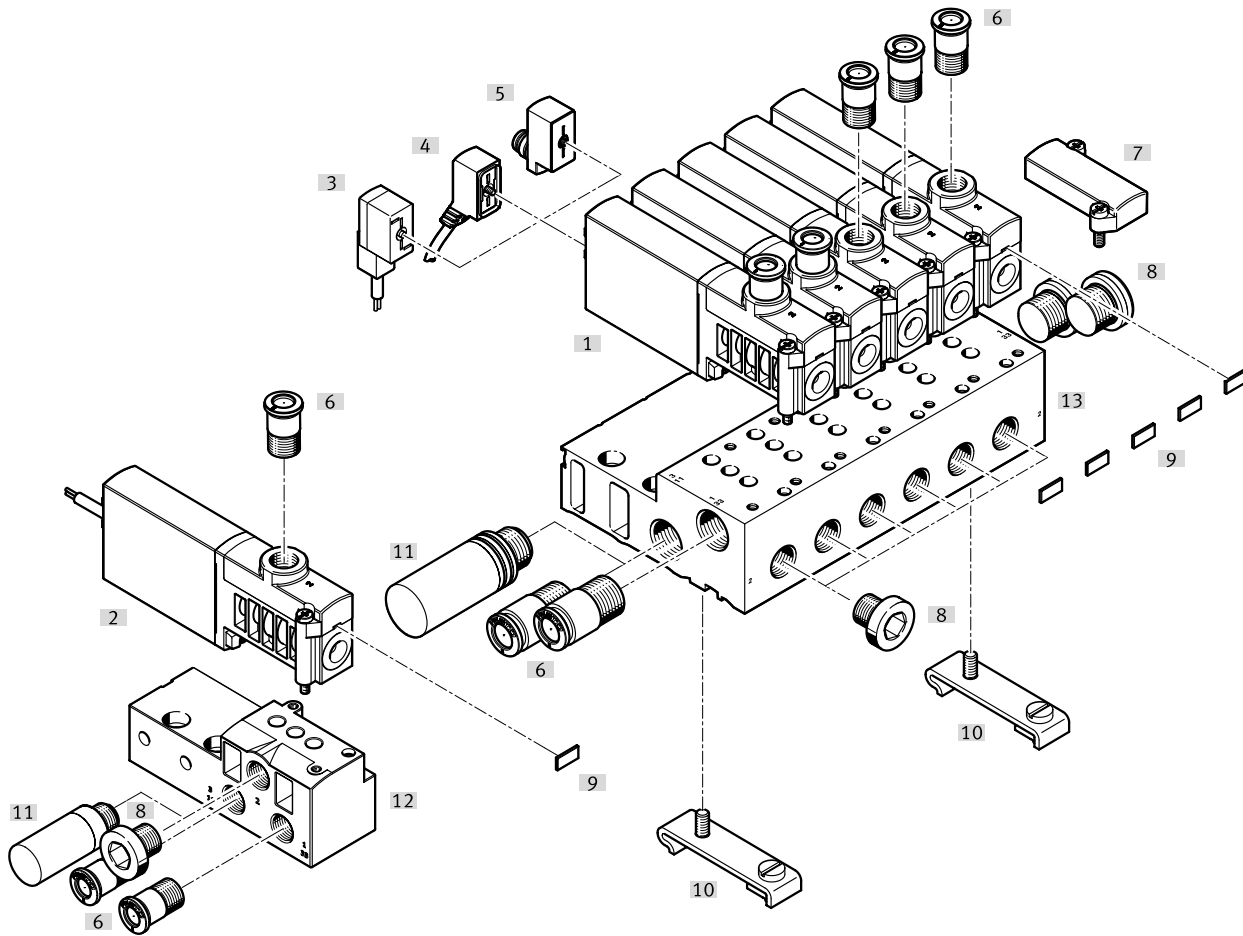

Designation	Type	Description	→ Page/Internet
[1] Semi in-line valve	MHP3	With plug vanes	70
[2] Semi in-line valve	MHP3-...-K	With moulded-in cable, IP65	73
[3] Plug socket with cable	KMYZ-4	PVC cable, without signal status indication, IP50	73
[4] Connecting cable	NEBV	PUR cable, signal status indication with LED, IP65	73
[5] Adapter	VAVE-C8	For connecting the valves via connecting cable M8 3-pin or 4-pin, IP65	73
[6] Push-in fittings	QS	For connecting compressed air tubing with standard O.D.	74
[7] Cover plate	MHAP3-BP-3	For sealing vacant positions	73
[8] Blanking plug	B	For sealing unused ports	74
[9] Inscription label	MH-BZ-80X	For identifying the valves	74
[10] H-rail mounting	CPV10/14-VI-BG-NRH-35	For mounting the manifold block on H-rails to EN 60715	74
[11] Silencer	UC	For fitting in exhaust ports	74
[12] Individual sub-base	MHA3-AS-3-1/8	For semi in-line valves; the individual sub-base is also used for sub-base valves and must be sealed with a blanking plug here	73
[13] Manifold block	MHA3-PR	For semi in-line valves	73

Datasheet – Semi in-line valve

Function

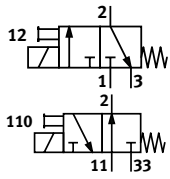

Voltage
24 V DC



Pressure
-0.09 ... +0.8 MPa



Temperature range
-5 ... +40°C



General technical data

Valve function		3/2 way, single solenoid ¹⁾
Design		Pressure relief poppet valve
Overlap		Negative overlap
Sealing principle		Soft
Reset method		Mechanical spring
Actuation type		Electrical
Type of control		Direct
Direction of flow		Reversible with restrictions ²⁾
Exhaust function		Can be throttled
Manual override		Non-detenting
Mounting position		Any
Width	[mm]	14
Grid dimension	[mm]	19
Note on grid dimension		Minimum distance between the valves is 5 mm
Nominal width	[mm]	3
Standard nominal flow rate	[l/min]	200
Type of mounting		On PR rail
Pneumatic connection	2	Connecting thread G1/8, push-in connector for tubing O.D. 6 mm
	1, 11, 3, 33	Sub-base
Product weight	[g]	120

1) Can be used as a 2/2-way valve by sealing port 3 or 33

2) Slight leakage can occur in the pressure range -0.8 bar to +0.5 bar.

Datasheet – Semi in-line valve

Operating and environmental conditions		With fast-switching electronics	Without fast-switching electronics	
Operating medium		Compressed air to ISO 8573-1:2010 [7:4:4]		
Note on the operating/pilot medium		Lubricated operation possible (in which case lubricated operation will always be required)		
Operating pressure	[MPa]	-0.09 ... +0.8		
	[bar]	-0.9 ... +8		
	Reversible	[MPa]	-0.09 ... +0.1	
		[bar]	-0.9 ... +1	
	[psi]	-13.05 ... +14.5		
Ambient temperature		[°C] -5 ... +40		
Temperature of medium		[°C] -5 ... +40		
Restricted ambient temperature and temperature of medium		As a function of switching frequency	-	
Corrosion resistance class CRC ¹⁾		2	2	
CE marking (see declaration of conformity) ³⁾		To EU EMC Directive ²⁾	-	
		To EU RoHS Directive	-	
UKCA marking (see declaration of conformity) ³⁾		To UK instructions for EMC	-	
		To UK RoHS instructions	-	
Certification		c UL us - Recognized (OL)	c UL us - Recognized (OL)	
		RCM	-	
Cleanroom class		Class 6 to ISO 14644-1		
Shock resistance		Shock test with severity level 2 to FN 942017-5 and EN 60068-2-27		
Vibration resistance		Transport application test with severity level 2 to FN 942017-4 and EN 60068-2-6		

1) More information: www.festo.com/x/topic/kbk

2) For information about the area of use, see the EC declaration of conformity at: www.festo.com/catalogue/mh21 → Support/Downloads.

If the devices are subject to usage restrictions in residential, commercial or light-industrial environments, further measures for the reduction of the emitted interference may be necessary.

3) More information: www.festo.com/catalogue/... → Support/Downloads.

Electrical data		With fast-switching electronics	Without fast-switching electronics
Electrical connection		2-pin plug or cable	
Operating voltage	[V DC]	24	
Permissible voltage fluctuations	[%]	±10	
Power consumption	[W]	6.5 (high-current phase)	3.7
	[W]	1.6 (low-current phase)	-
Reverse polarity protection		Bipolar	
Duty cycle	[%]	100	100
Additional functions		Spark arresting	-
		Holding current reduction	-
		Protective circuit	-
Degree of protection to EN 60529		IP65	IP65

Switching times and frequencies		With fast-switching electronics	Without fast-switching electronics
Switching time	On [ms]	2.3	8.3
	Off [ms]	2.8	4.5
Tolerance for switching time	On [%]	+10 ... -30	-
	Off [%]	+10 ... -50	-
Switching time variation from 1 Hz upwards	[ms]	0.2	-
Maximum switching frequency	[Hz]	280	130

Materials	
Housing	Coated die-cast zinc
Cable sheath	PUR
Seals	HNBR, NBR
Screws	Galvanised steel
Note on materials	RoHS-compliant
PWIS conformity	VDMA24364-B1/B2-L

Datasheet – Semi in-line valve

Restricted ambient temperature and temperature of medium as a function of switching frequency

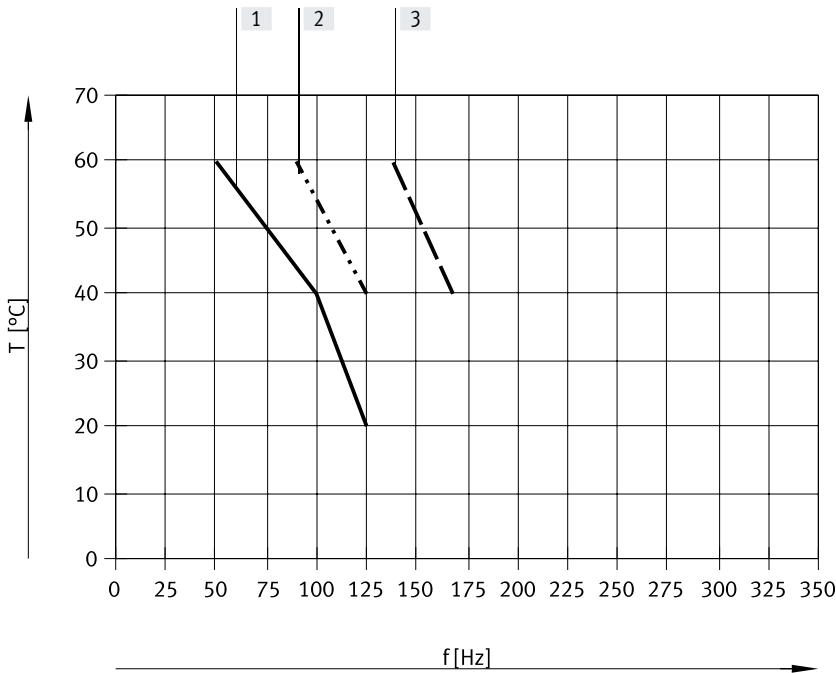

- [1] Valve manifold assembly, 6 valves, unpressurised
- [2] Valve manifold assembly, 6 valves, through-flow, 0.6 MPa
- [3] Individual valve, unpressurised

No restrictions for individual valve, through-flow, 0.6 MPa.

Current curve for valves with fast-switching electronics (MHP3-MS1H)

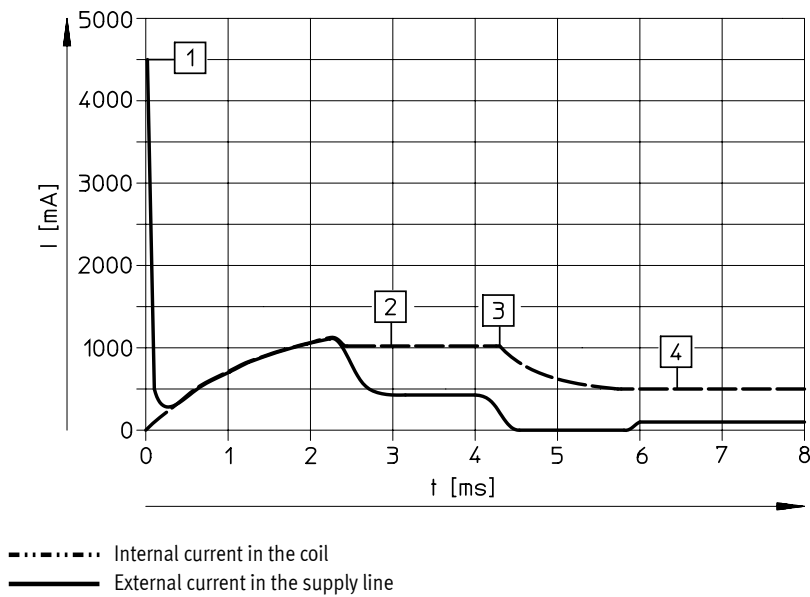

- [1] Capacitor charging
- [2] Controlled coil current 1 A
- [3] Holding current reduction
- [4] Controlled holding current 0.5 A

----- Internal current in the coil
 — External current in the supply line

Datasheet – Semi in-line valve

Dimensions

Download CAD data → www.festo.com

Valve with connecting thread G1/8

Valve with push-in connector for tubing O.D. 6 mm

MHP3-...-G1/8

MHP3-...-QS6

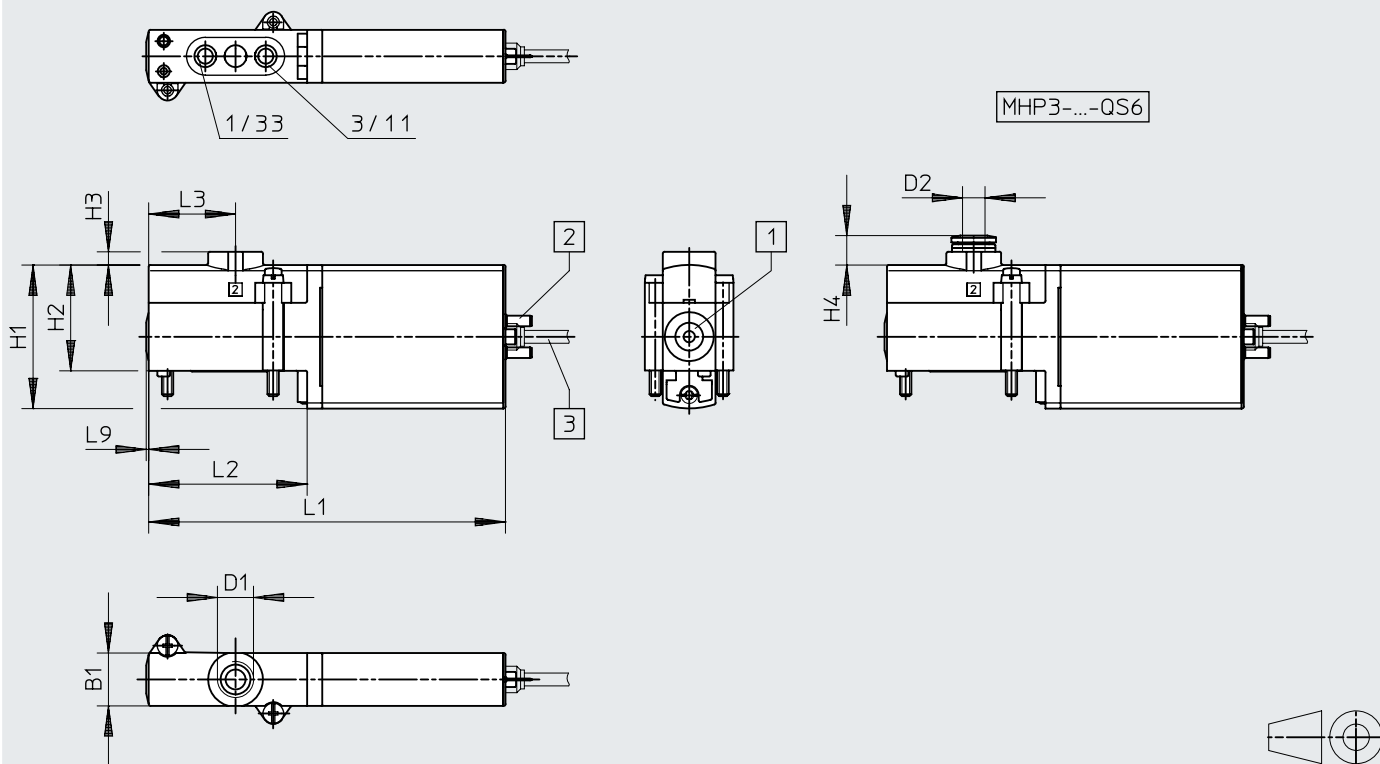

[1] Manual override, non-detenting

[2] Plug vanes

[3] Cable, 2.5 m

Type	B1	D1	D2 ∅	H1	H2	H3	H4	L1	L2	L3	L9
MHP3-...-3/2...	14	G1/8	6	38	28	3.5	7.8	94.5	42	23	0.6

Datasheet – Semi in-line valve

Dimensions

Download CAD data → www.festo.com

Hole pattern on sub-bases

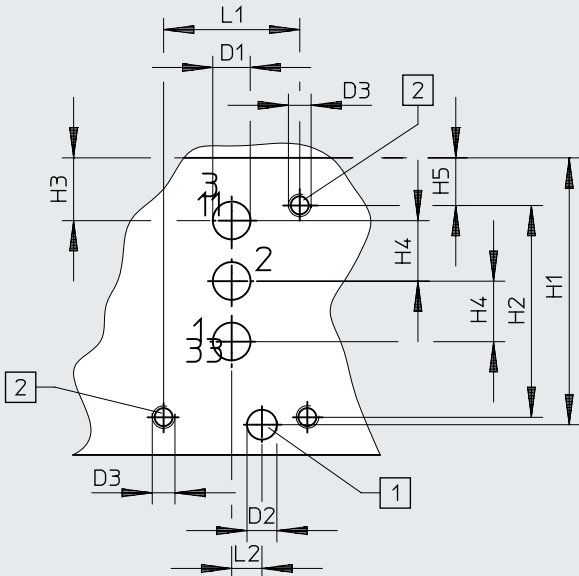

[1] Hole for coding pin, 2mm deep [2] Mounting thread, 8 mm deep

Note
 With semi in-line valves, port 2 is not used.
 If used as a 2/2-way valve, normally closed, ports 3/11 are not used.
 If used as a 2/2-way valve, normally open, ports 1/33 are not used.

Individual sub-base, MHA3-AS-3-1/8

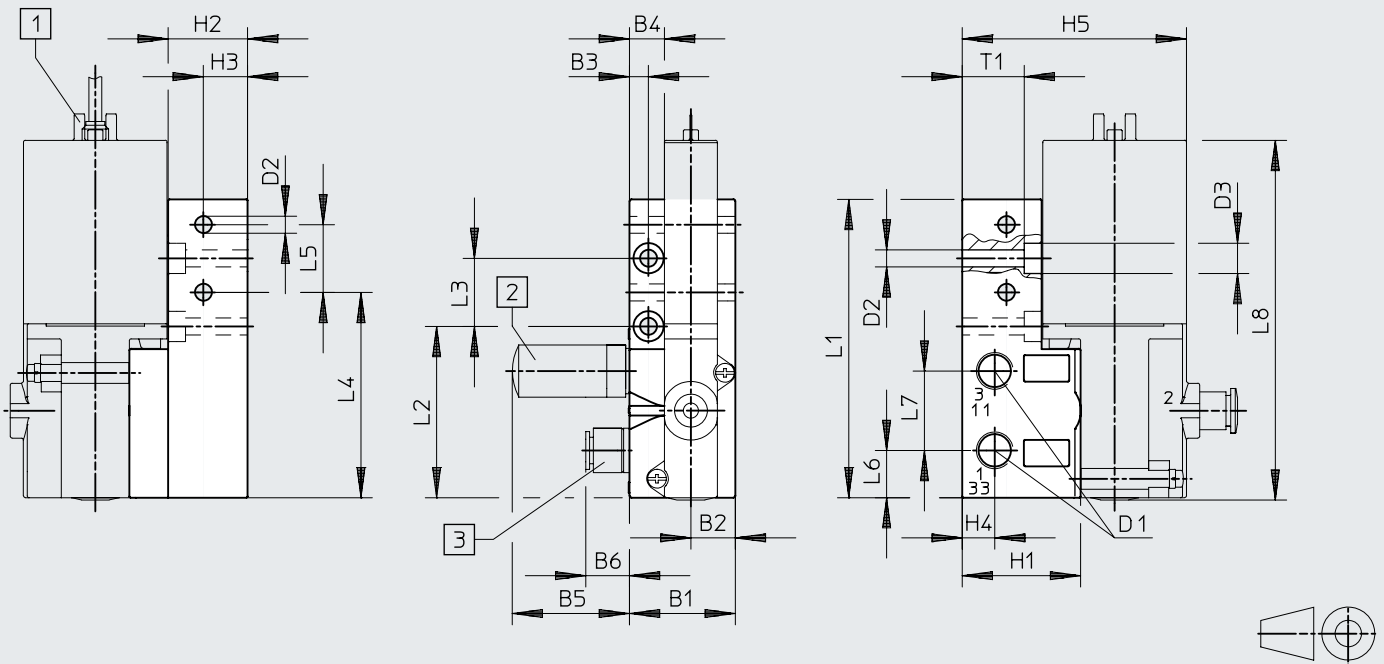

[1] Plug vanes [2] Silencer [3] Push-in fitting

Type	B1	B2	B3	B4	B5	B6	D1	D2 ∅	D3 ∅	H1	H2	H3	H4	H5
Hole pattern	-	-	-	-	-	-	5	4	M3	35.3	28	8.3	8	6.3
MHA3-AS-3-1/8	28	11.8	5	9.3	31.5	13.3	G1/8	4.5	8	31.3	21	11.7	8.6	59.3

Type	L1	L2	L3	L4	L5	L6	L7	L8	T1
Hole pattern	18	4	-	-	-	-	-	-	-
MHA3-AS-3-1/8	78.9	45.3	18	54.3	17.9	12.5	21	95	16.4

Datasheet – Semi in-line valve

Dimensions

Download CAD data → www.festo.com

Manifold assembly, MHA3-PR...-1/8

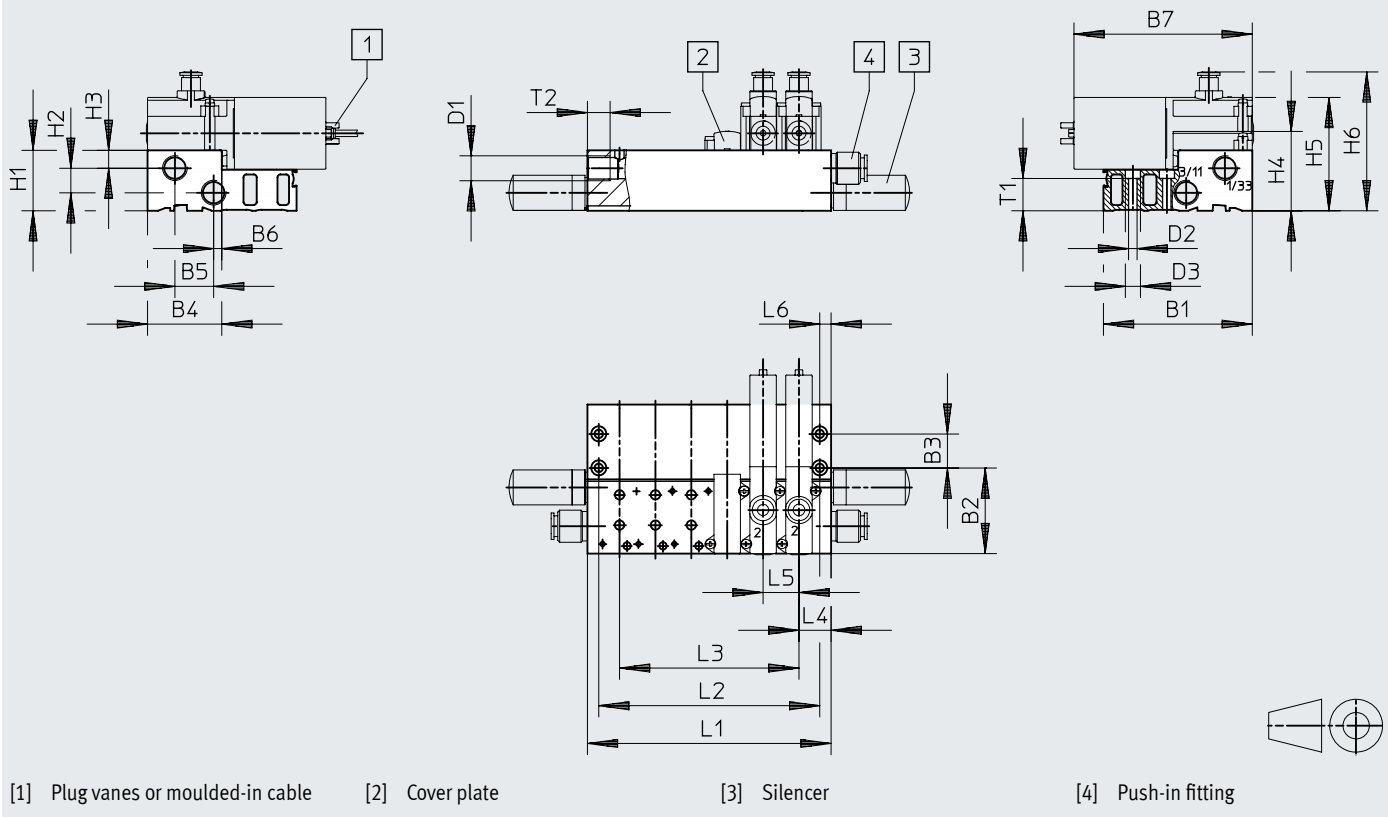

H-rail mounting CPV1 0/14-VI-BG-NRH-35

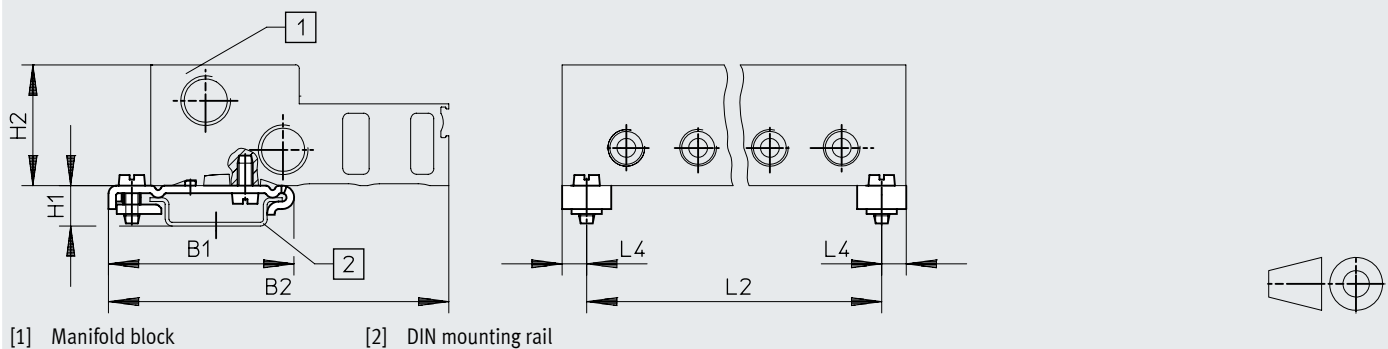







Type	B1	B2	B3	B4	B5	B6	B7	D1	D2 ∅	D3 ∅	H1	H2	H3	H4	H5	H6	L4	L5	L6	T1	T2
MHA3-PR...-1/8	79	45.3	18	39.3	20.5	4.3	94.5	G1/4	4.5	8	32	13	9.5	42	60	73.5	17	19	6	17.1	12
CPV1 0/14-VI-BG...	49.1	90	-	-	-	-	-	-	-	-	10.7	32	-	-	-	-	6.5	-	-	-	-

Type	Number of valve positions				
	2	4	6	8	10
MHA3-PR...-1/8	L1	53	91	129	205
	L2	41	79	117	193
	L3	19	57	95	133
CPV1 0/14-VI-BG...	L2	40	78	116	192

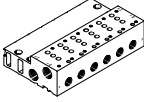

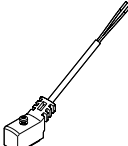
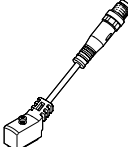

Note
 Valve types 3/2G and 3/2O must not be mixed on one manifold block.

Datasheet – Semi in-line valve

Ordering data					Part no.	Type
Valves						
	Electrical connection: 2-pin plug	With fast-switching electronics, switching time 2.3 ms	Pneumatic connection: thread G1/8	Normally open	525159	MHP3-MS1H-3/20-1/8
			Pneumatic connection: push-in connector for tubing O.D. 6 mm	Normally closed	525139	MHP3-MS1H-3/2G-1/8
				Normally closed	525143	MHP3-MS1H-3/2G-QS-6
		Without fast-switching electronics, switching time 8.3 ms	Pneumatic connection: thread G1/8	Normally open	525158	MHP3-M1H-3/20-1/8
			Pneumatic connection: push-in connector for tubing O.D. 6 mm	Normally closed	525138	MHP3-M1H-3/2G-1/8
				Normally closed	525142	MHP3-M1H-3/2G-QS-6
	Electrical connection: cable	With fast-switching electronics, switching time 2.3 ms	Pneumatic connection: push-in connector for tubing O.D. 6 mm	Normally closed	525145	MHP3-MS1H-3/2G-QS-6-K
Manifold rail						
	Individual sub-base ¹⁾ Pneumatic connection: thread G1/8			1 valve position	525214	MHA3-AS-3-1/8
	Manifold block ¹⁾ Pneumatic connection 1, 11, 3, 33: thread G1/4 Pneumatic connection 2: thread G1/8			2 valve positions	525221	MHA3-PR2-3-1/8
				4 valve positions	525222	MHA3-PR4-3-1/8
				6 valve positions	525223	MHA3-PR6-3-1/8
				8 valve positions	525224	MHA3-PR8-3-1/8
				10 valve positions	525225	MHA3-PR10-3-1/8
Cover plate						
	Vacant valve positions must be sealed with a cover plate.				525226	MHAP3-BP-3
Connecting cable (for valves with 2-pin plug)					Datasheets → Internet: nebv	
	2-pin socket, open cable end, 2-wire	PUR cable, degree of protection IP65	Signal status indication with LED	Length 2.5 m	8047671	NEBV-Z4WA2L-P-E-2.5-N-LE2-S1
				Length 5 m	8047672	NEBV-Z4WA2L-P-E-5-N-LE2-S1
				Length 10 m	8047670	NEBV-Z4WA2L-P-E-10-N-LE2-S1
		PVC cable, degree of protection IP40	Without signal status indication	Length 0.5 m	193690	KMYZ-4-24-0.5-B
				Length 2.5 m	193691	KMYZ-4-24-2.5-B
	2-pin socket, plug M8x1 3-pin	PUR cable, degree of protection IP65	Signal status indication with LED	Length 0.5 m	8047673	NEBV-Z4WA2L-P-E-0.5-N-M8G3-S1
				Length 2.5 m	8047674	NEBV-Z4WA2L-P-E-2.5-N-M8G3-S1
Adapter (for valves with 2-pin plug)						
	2-pin socket	Signal status indication with LED	Plug M8, 3-pin	571686	VAVE-C8-1R8	
			Plug M8, 4-pin	573194	VAVE-C8-1R1	

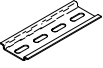
1) Seal port 2 with a blanking plug. These ports have no function when using semi in-line valves.

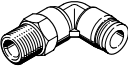
Datasheet – Semi in-line valve

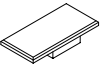
Ordering data			Part no.	Type
H-rail mounting				
	For manifold block		162556	CPV10/14-VI-BG-NRH-35
H-rail				
	To EN 60715	2 m	35430	NRH-35-2000
Silencer Datasheets → Internet: uc				
	Push-in sleeve with O.D. 6 mm		1 piece	165007 UC-QS-6H
	With threaded connection	G1/8	1 piece	161419 UC-1/8
			50 pieces	534219 UC-1/8-50
		G1/4	1 piece	165004 UC-1/4
			20 pieces	534220 UC-1/4-20
Push-in fitting Datasheets → Internet: qs				
	Male thread G1/8 with external hex for tubing O.D.	6 mm	10 pieces	186096 QS-G1/8-6
			100 pieces	132037 QS-G1/8-6-100
		8 mm	10 pieces	186098 QS-G1/8-8
			50 pieces	132038 QS-G1/8-8-50
	Male thread G1/4 with external hex for tubing O.D.	8 mm	10 pieces	186099 QS-G1/4-8
			50 pieces	132040 QS-G1/4-8-50
		10 mm	10 pieces	186101 QS-G1/4-10
			50 pieces	132041 QS-G1/4-10-50
	Male thread G1/8 with external hex, push-in L-fitting rotatable through 360°, for tubing O.D.	6 mm	10 pieces	186117 QSL-G1/8-6
			100 pieces	132049 QSL-G1/8-6-100
		8 mm	10 pieces	186119 QSL-G1/8-8
			50 pieces	132050 QSL-G1/8-8-50
	Male thread G1/4 with external hex, push-in L-fitting rotatable through 360°, for tubing O.D.	8 mm	10 pieces	186120 QSL-G1/4-8
			50 pieces	132052 QSL-G1/4-8-50
		10 mm	10 pieces	186122 QSL-G1/4-10
			50 pieces	132053 QSL-G1/4-10-50
Blanking plug				
	For thread G1/8		10 pieces	3568 B-1/8
	For thread G1/4		10 pieces	3569 B-1/4
Inscription label				
	For solenoid valve	80 pieces in a frame	197259	MH-BZ-80X

Peripherals overview – Sub-base valve

Connection with plug vanes – Connection with moulded-in cable

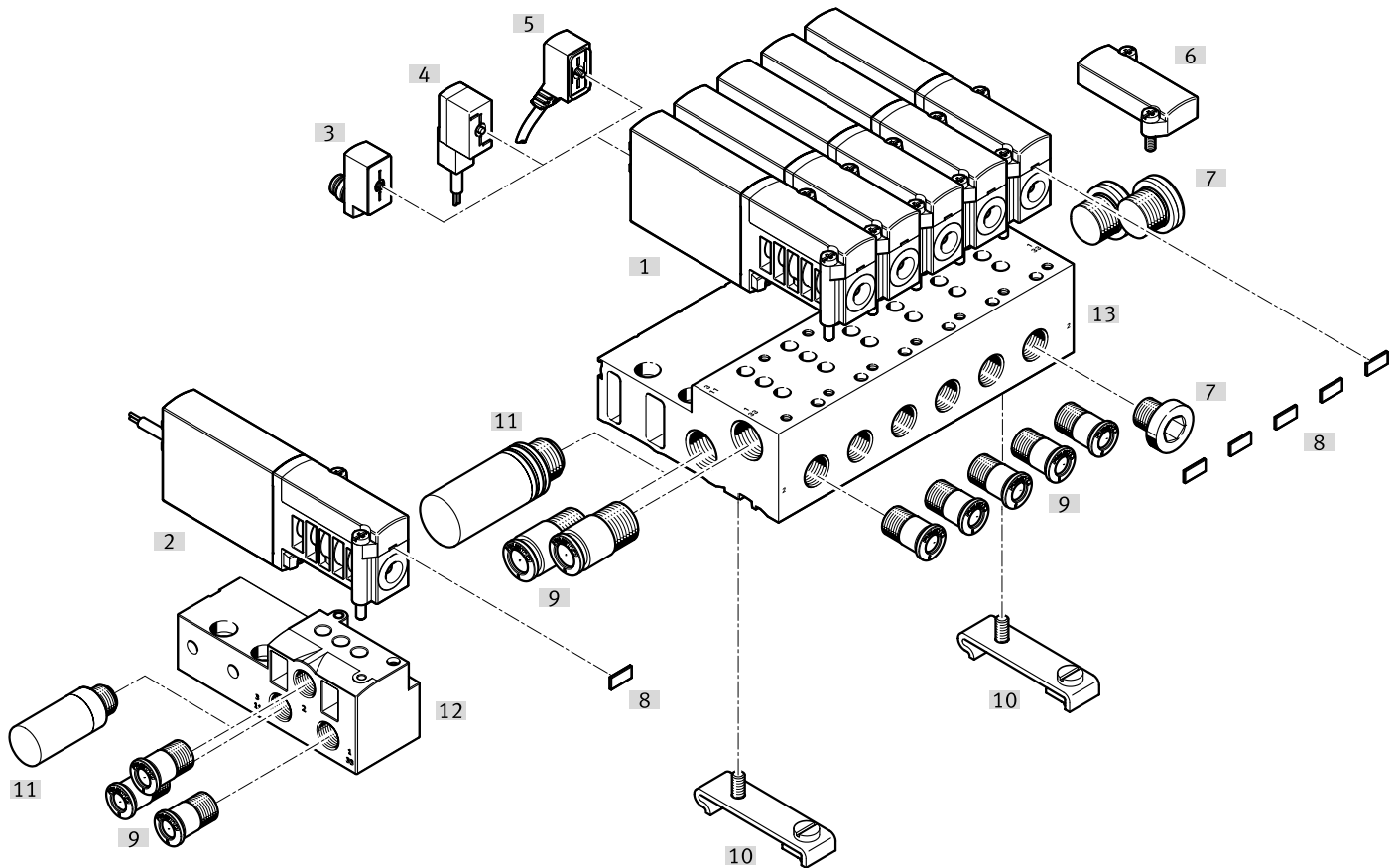



Designation	Type	Description	→ Page/Internet
[1] Sub-base valve	MHA3	With plug vanes	78
[2] Sub-base valve	MHA3-...-K	With moulded-in cable, IP65	82
[3] Adapter	VAVE-C8	For connecting the valves via connecting cable M8 3-pin or 4-pin, IP65	82
[4] Plug socket with cable	KMYZ-4	PVC cable, without signal status indication, IP50	82
[5] Connecting cable	NEBV	PUR cable, signal status indication with LED, IP65	82
[6] Cover plate	MHAP3-BP-3	For sealing vacant positions	82
[7] Blanking plug	B	For sealing unused ports	83
[8] Inscription label	MH-BZ-80X	For identifying the valves	83
[9] Push-in fittings	QS	For connecting compressed air tubing with standard O.D.	83
[10] H-rail mounting	CPV10/14-VI-BG-NRH-35	For mounting the manifold block on H-rails to EN 60715	83
[11] Silencer	UC	For fitting in exhaust ports	83
[12] Individual sub-base	MHA3-AS-3-1/8	For sub-base valve	82
[13] Manifold block	MHA3-PR-...-3-1/8	For sub-base valve	82

Datasheet – Sub-base valve

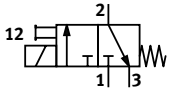
Function



-  - Voltage
24 V DC
-  - Pressure
-0.09 ... +0.8 MPa
-  - Temperature range
-5 ... +40°C



General technical data

Valve function	3/2 way, single solenoid ¹⁾
Design	Pressure relief poppet valve
Overlap	Negative overlap
Sealing principle	Soft
Reset method	Mechanical spring
Actuation type	Electrical
Type of control	Direct
Direction of flow	Reversible with restrictions ²⁾
Exhaust function	Can be throttled
Manual override	Non-detenting
Mounting position	Any
Width	[mm] 14
Grid dimension	[mm] 19
Note on grid dimension	Minimum distance between the valves is 5 mm
Nominal width	[mm] 3
Standard nominal flow rate	[l/min] 200
Type of mounting	On PR rail, via through-hole
Pneumatic connection	Sub-base
Product weight	[g] 120

1) Can be used as a 2/2-way valve by sealing port 3 or 33

2) Slight leakage can occur in the pressure range -0.8 bar to +0.5 bar.

Datasheet – Sub-base valve

Operating and environmental conditions		With fast-switching electronics	Without fast-switching electronics	
Operating medium		Compressed air to ISO 8573-1:2010 [7:4:4]		
Note on the operating/pilot medium		Lubricated operation possible (in which case lubricated operation will always be required)		
Operating pressure	[MPa]	-0.09 ... +0.8		
	[bar]	-0.9 ... +1		
	Reversible	[MPa]	-0.09 ... +0.1	
		[bar]	-0.9 ... +1	
	[psi]	-13.05 ... +14.5		
Ambient temperature		[°C] -5 ... +40		
Temperature of medium		[°C] -5 ... +40		
Restricted ambient temperature and temperature of medium		As a function of switching frequency	-	
Corrosion resistance class CRC ¹⁾		2	2	
CE marking (see declaration of conformity) ³⁾		To EU EMC Directive ²⁾	-	
		To EU RoHS Directive	-	
UKCA marking (see declaration of conformity) ³⁾		To UK instructions for EMC	-	
		To UK RoHS instructions	-	
Certification		c UL us - Recognized (OL)	c UL us - Recognized (OL)	
		RCM	-	
Cleanroom class		Class 6 to ISO 14644-1		
Shock resistance		Shock test with severity level 2 to FN 942017-5 and EN 60068-2-27		
Vibration resistance		Transport application test with severity level 2 to FN 942017-4 and EN 60068-2-6		

1) More information: www.festo.com/x/topic/kbk

2) For information about the area of use, see the EC declaration of conformity at: www.festo.com/catalogue/mh2 → Support/Downloads.

If the devices are subject to usage restrictions in residential, commercial or light-industrial environments, further measures for the reduction of the emitted interference may be necessary.

3) More information: www.festo.com/catalogue/... → Support/Downloads.

Electrical data		With fast-switching electronics	Without fast-switching electronics
Electrical connection		2-pin plug or cable	
Operating voltage	[V DC]	24	
Permissible voltage fluctuations	[%]	±10	
Power consumption	[W]	6.5 for approx. 4.5 ms (high-current phase, inrush current 1 A)	3.7
	[W]	1.6 (low-current phase)	-
Reverse polarity protection		Bipolar	
Duty cycle	[%]	100	100
Additional functions	Spark arresting		-
	Holding current reduction		-
	Protective circuit		-
Degree of protection to EN 60529		IP65	IP65

Switching times and frequencies		With fast-switching electronics	Without fast-switching electronics
Switching time	On [ms]	2.3	8.3
	Off [ms]	2.8	4.5
Tolerance for switching time	On [%]	+10 ... -30	-
	Off [%]	+10 ... -50	-
Switching time variation from 1 Hz upwards	[ms]	0.2	-
Maximum switching frequency	[Hz]	280	130

Materials	
Housing	Coated die-cast zinc
Cable sheath	PUR
Seals	HNBR, NBR
Screws	Galvanised steel
Note on materials	RoHS-compliant
PWIS conformity	VDMA24364-B1/B2-L

Datasheet – Sub-base valve

Restricted ambient temperature and temperature of medium as a function of switching frequency

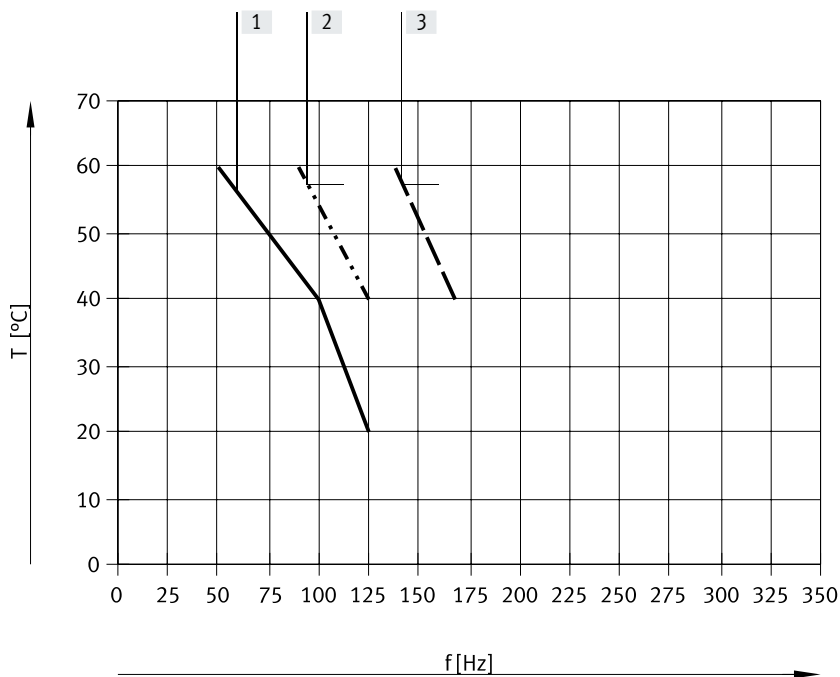

- [1] Valve manifold assembly, 6 valves, unpressurised
- [2] Valve manifold assembly, 6 valves, through-flow, 0.6 MPa
- [3] Individual valve, unpressurised

No restrictions for individual valve, through-flow, 0.6 MPa.

Current curve for valves with fast-switching electronics (MHA3-MS1H)

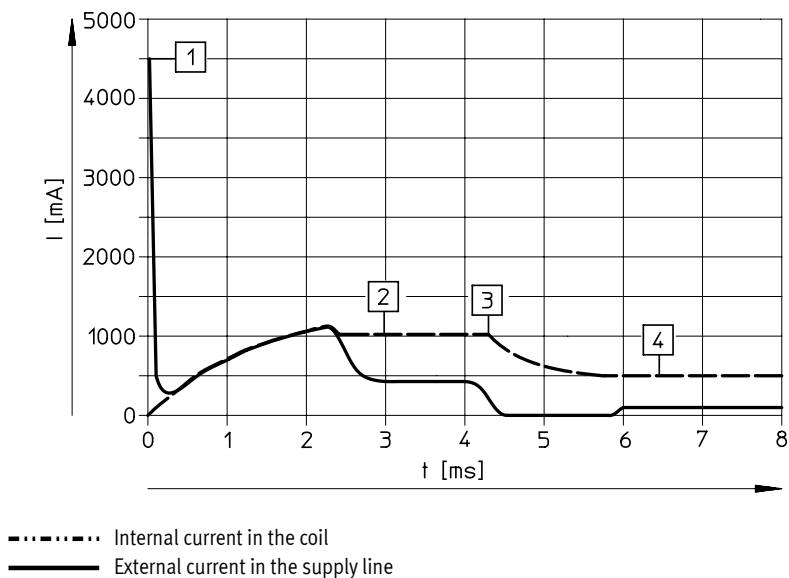

- [1] Capacitor charging
- [2] Controlled coil current 1 A
- [3] Holding current reduction
- [4] Controlled holding current 0.5 A

----- Internal current in the coil
 ——— External current in the supply line

Datasheet – Sub-base valve

Dimensions

Download CAD data → www.festo.com

Valve with plug vanes or moulded-in cable, MHA3-...-3/2G...

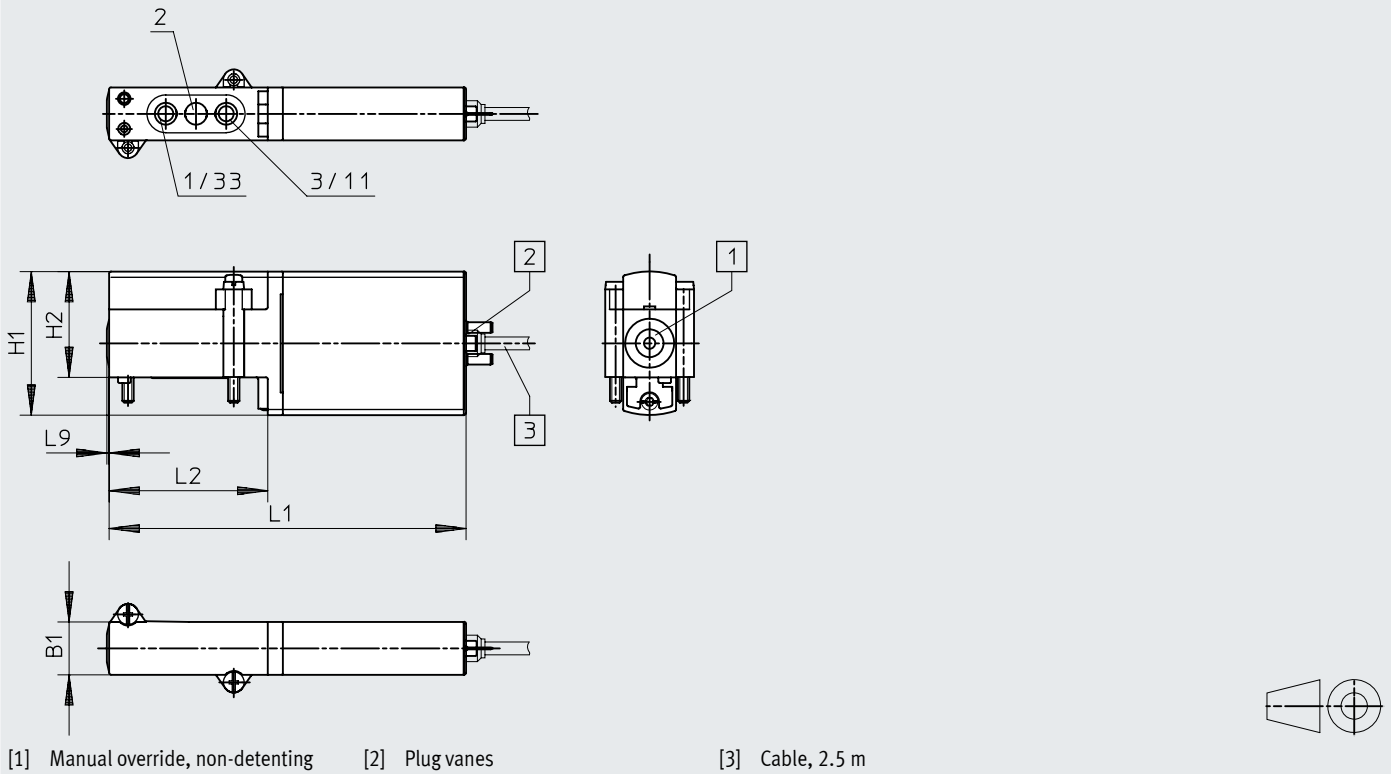

Hole pattern on sub-bases

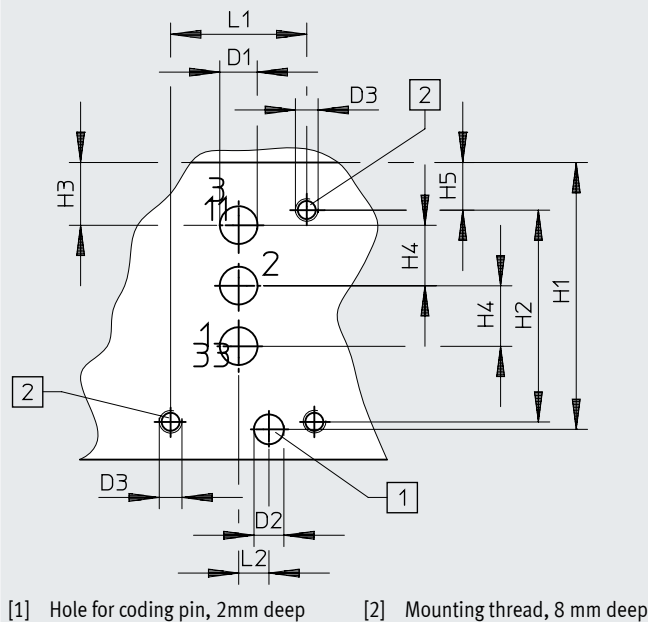

Type	B1	D1	D2 ∅	D3 ∅	H1	H2	H3	H4	H5	L1	L2	L9
MHA3-...-3/2G...	14	-	-	-	38	28	-	-	-	94.5	42	0.6
Hole pattern	-	5	4	M3	35.3	28	8.3	8	6.3	18	4	-

Datasheet – Sub-base valve

Dimensions

Download CAD data → www.festo.com

Individual sub-base, MHA3-AS-3-1/8

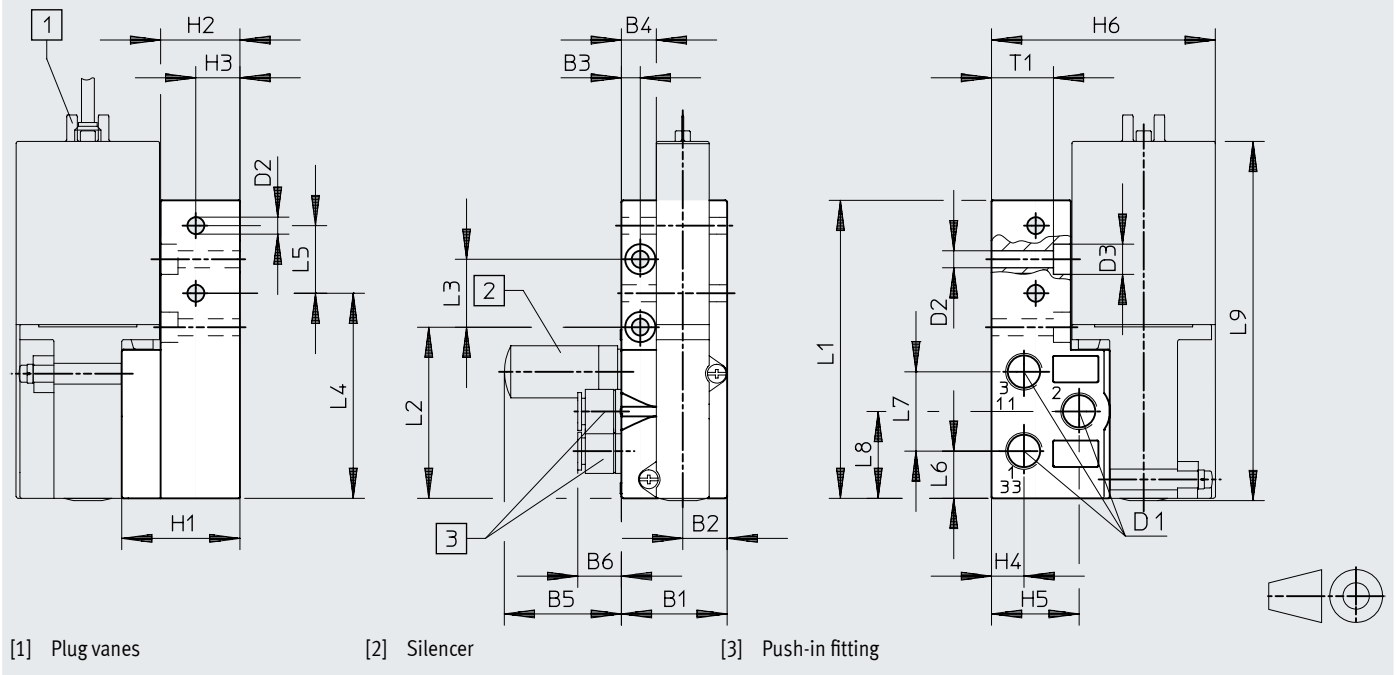

Type	B1	B2	B3	B4	B5	B6	D1	D2 ∅	D3 ∅	H1	H2	H3	H4	H5	H6
MHA3-AS-3-1/8	28	11.8	5	9.3	31.5	13.3	G1/8	4.5	8	31.3	21	11.7	8.6	23.2	59.3

Type	L1	L2	L3	L4	L5	L6	L7	L8	L9	T1
MHA3-AS-3-1/8	78.9	45.3	18	54.3	17.9	12.5	21	23	95	16.4

Datasheet – Sub-base valve

Dimensions

Download CAD data → www.festo.com

Manifold assembly, MHA3-PR...-1/8

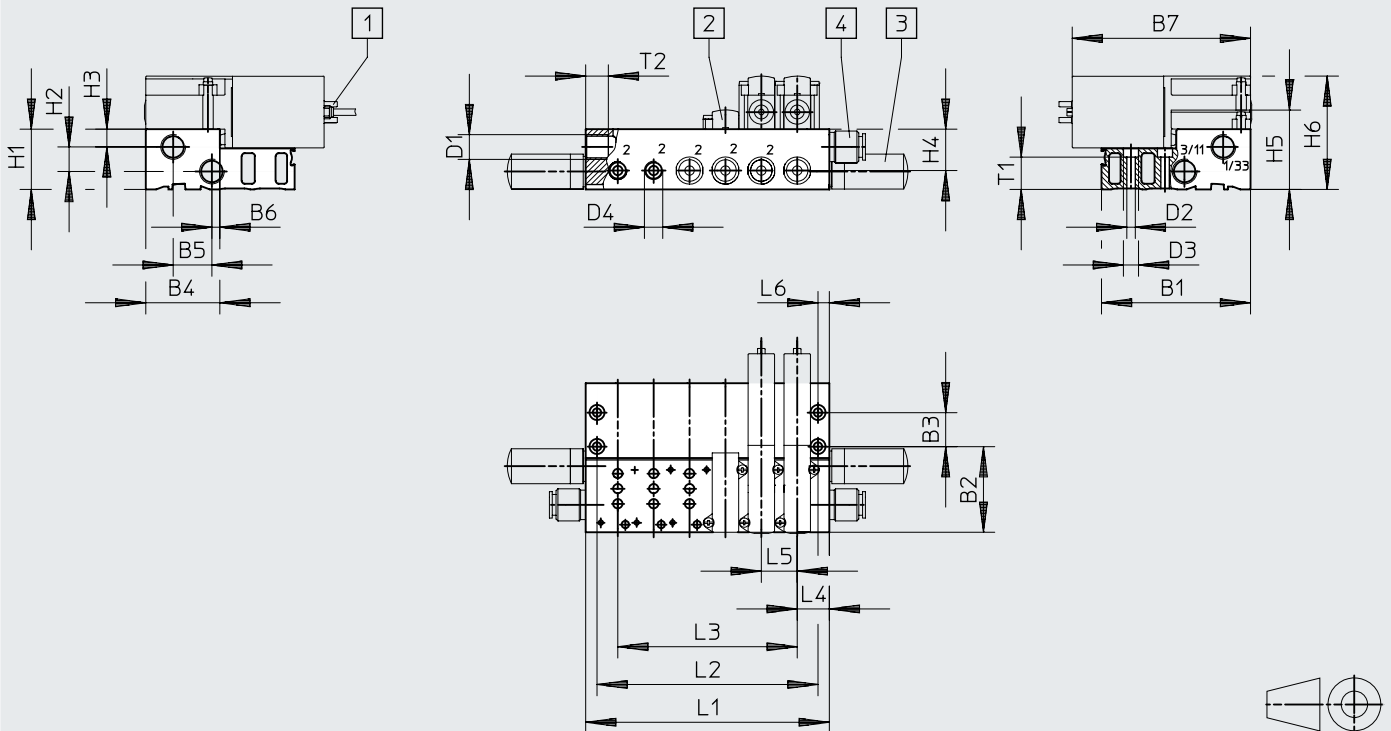

[1] Plug vanes or moulded-in cable [2] Cover plate [3] Silencer [4] Push-in fitting

H-rail mounting CPV1 0/14-VI-BG-NRH-35

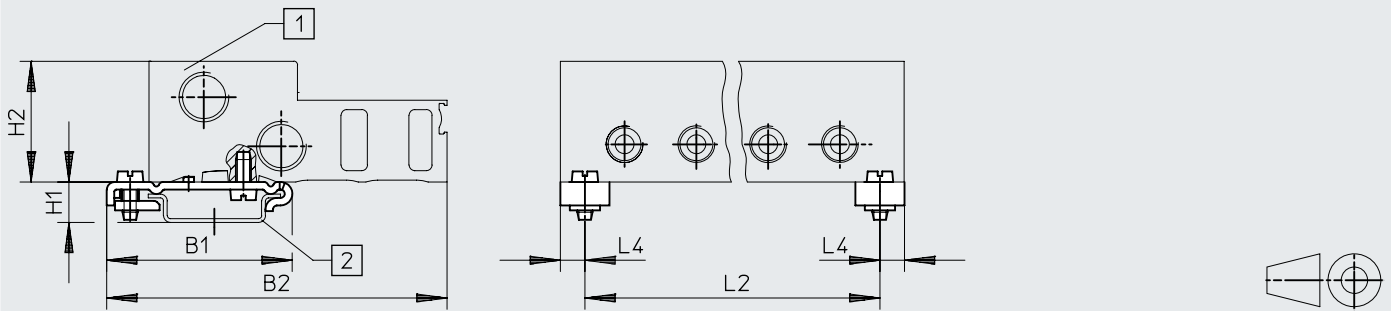







[1] Manifold block [2] DIN mounting rail

Type	B1	B2	B3	B4	B5	B6	B7	D1	D2 ∅	D3 ∅	D4 ∅	H1	H2	H3	H4	H5	H6
MHA3-PR...-1/8	79	45.3	18	39.3	20.5	4.3	94.3	G1/4	4.5	8	G1/8	32	13	9.5	22	42	60
CPV1 0/14-VI-BG-...	49.1	90	-	-	-	-	-	-	-	-	-	10.7	32	-	-	-	-

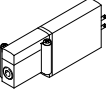
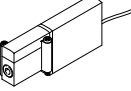

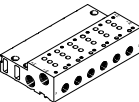

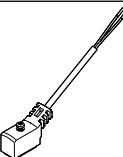
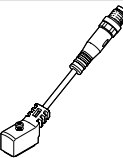
Type	L4	L5	L6	T1	T2
MHA3-PR...-1/8	17	19	6	17.1	12
CPV1 0/14-VI-BG-...	6.5	-	-	-	-

Type		Number of valve positions				
		2	4	6	8	10
MHA3-PR...-1/8	L1	53	91	129	167	205
	L2	41	79	117	155	193
	L3	19	57	95	133	171
CPV1 0/14-VI-BG-...	L2	41	79	117	155	193

Datasheet – Sub-base valve

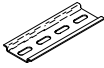
Ordering data				Part no.	Type	
Valves						
	Electrical connection: 2-pin plug	With fast-switching electronics, switching time 2.3 ms	Normally closed	525135	MHA3-MS1H-3/2G-3	
		Without fast-switching electronics, switching time 8.3 ms	Normally closed	525134	MHA3-M1H-3/2G-3	
	Electrical connection: cable	With fast-switching electronics, switching time 2.3 ms	Normally closed	525137	MHA3-MS1H-3/2G-3-K	
		Without fast-switching electronics, switching time 8.3 ms	Normally closed	525136	MHA3-M1H-3/2G-3-K	
Manifold rail						
	Individual sub-base Pneumatic connection: thread G1/8		1 valve position	525214	MHA3-AS-3-1/8	
	Manifold block Pneumatic connection 1, 11, 3, 33: thread G1/4 Pneumatic connection 2: thread G1/8		2 valve positions	525221	MHA3-PR2-3-1/8	
			4 valve positions	525222	MHA3-PR4-3-1/8	
			6 valve positions	525223	MHA3-PR6-3-1/8	
			8 valve positions	525224	MHA3-PR8-3-1/8	
			10 valve positions	525225	MHA3-PR10-3-1/8	
Cover plate						
	Vacant valve positions must be sealed with a cover plate.			525226	MHAP3-BP-3	
Connecting cable (for valves with 2-pin plug)				Datasheets → Internet: nebv		
	2-pin socket, open cable end 2-wire	PUR cable, degree of protection IP65	Signal status indication with LED	Length 2.5 m	8047671	NEBV-Z4WA2L-P-E-2.5-N-LE2-S1
				Length 5 m	8047672	NEBV-Z4WA2L-P-E-5-N-LE2-S1
		PVC cable, degree of protection IP40	Without signal status indication	Length 0.5 m	193690	KMYZ-4-24-0.5-B
				Length 2.5 m	193691	KMYZ-4-24-2.5-B
	2-pin socket, plug M8x1 3-pin	PUR cable, degree of protection IP65	Signal status indication with LED	Length 0.5 m	8047673	NEBV-Z4WA2L-P-E-0.5-N-M8G3-S1
				Length 2.5 m	8047674	NEBV-Z4WA2L-P-E-2.5-N-M8G3-S1
Adapter (for valves with 2-pin plug)						
	2-pin socket	Signal status indication with LED	Plug M8, 3-pin	571686	VAVE-C8-1R8	
			Plug M8, 4-pin	573194	VAVE-C8-1R1	

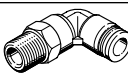
Datasheet – Sub-base valve

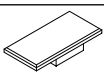
Ordering data			Part no.	Type	
H-rail mounting					
	For manifold block		162556	CPV10/14-VI-BG-NRH-35	
H-rail					
	To EN 60715	2 m	35430	NRH-35-2000	
Silencer Datasheets → Internet: uc					
	With threaded connection	G1/8	1 piece	161419	UC-1/8
			50 pieces	534219	UC-1/8-50
		G1/4	1 piece	165004	UC-1/4
			20 pieces	534220	UC-1/4-20
Push-in fitting Datasheets → Internet: qs					
	Male thread G1/8 with external hex for tubing O.D.	6 mm	10 pieces	186096	QS-G1/8-6
			100 pieces	132037	QS-G1/8-6-100
		8 mm	10 pieces	186098	QS-G1/8-8
	Male thread G1/4 with external hex for tubing O.D.	8 mm	10 pieces	186099	QS-G1/4-8
			50 pieces	132040	QS-G1/4-8-50
		10 mm	10 pieces	186101	QS-G1/4-10
	Male thread G1/8 with external hex, push-in L-fitting rotatable through 360° for tubing O.D.	6 mm	10 pieces	186117	QSL-G1/8-6
			100 pieces	132049	QSL-G1/8-6-100
		8 mm	10 pieces	186119	QSL-G1/8-8
	Male thread G1/4 with external hex, push-in L-fitting rotatable through 360°, for tubing O.D.	8 mm	50 pieces	132050	QSL-G1/8-8-50
			10 pieces	186120	QSL-G1/4-8
		50 pieces	132052	QSL-G1/4-8-50	
10 mm	10 pieces	186122	QSL-G1/4-10		
	50 pieces	132053	QSL-G1/4-10-50		
Blanking plug					
	For thread G1/8	10 pieces	3568	B-1/8	
	For thread G1/4	10 pieces	3569	B-1/4	
Inscription label					
	For solenoid valve	80 pieces in a frame	197259	MH-BZ-80X	

Peripherals overview – Individual valve

Connection with plug vanes – Connection with moulded-in cable

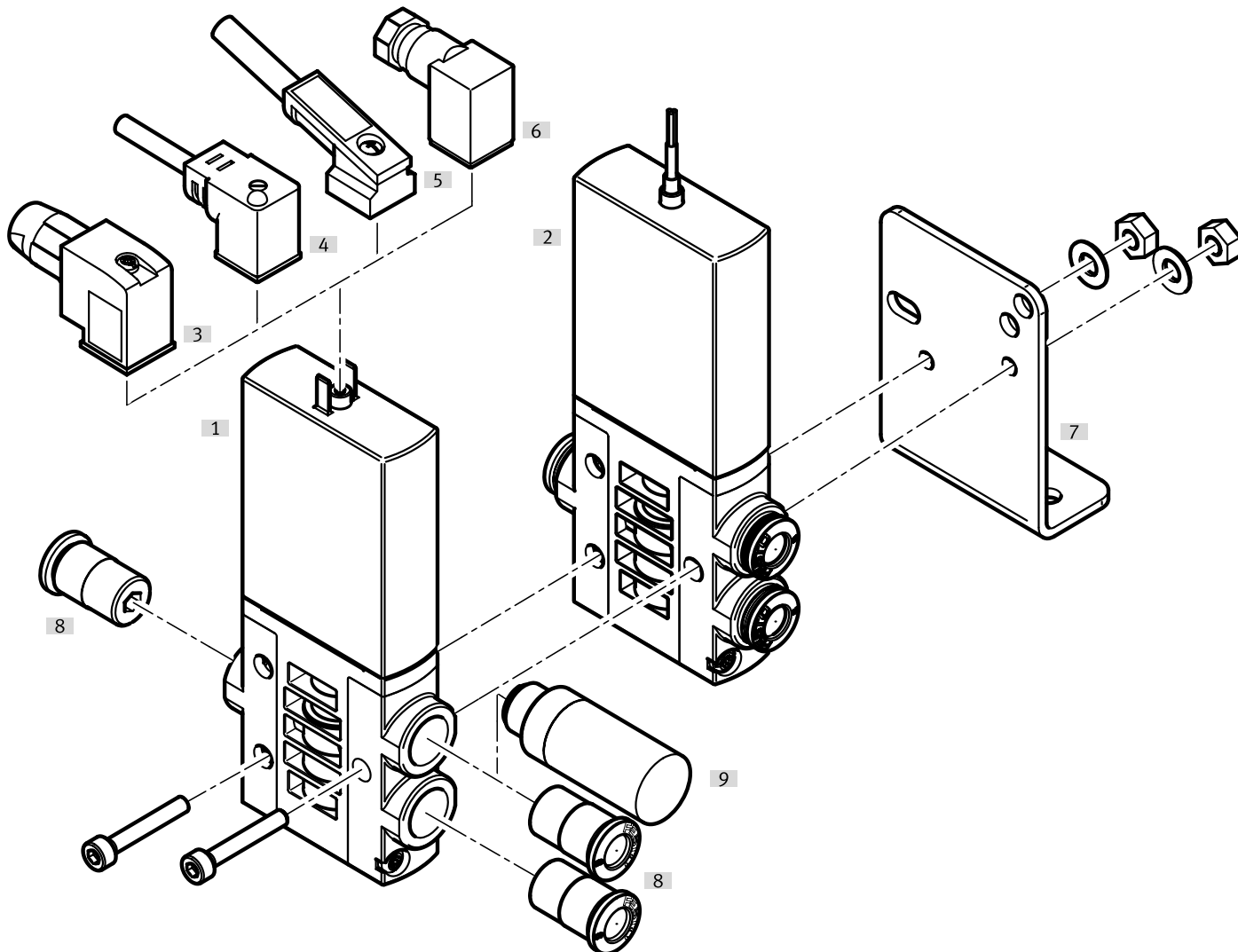



Designation	Type	Description	→ Page/Internet
[1] Individual valve	MHE4	With plug vanes	84
[2] Individual valve	MHE4-...-K	With moulded-in cable, IP65	89
[3] Plug socket	MSSD-EB-S-M14	With insulation displacement connector	90
[4] Plug socket with cable	KMEB-1	PVC cable, with or without LED	90
[5] Plug socket with cable	KMEB-2	With LED, without LED; PUR cable, with or without LED	90
[6] Plug socket	MSSD-EB	With clamping screw	90
[7] Mounting bracket	MHE2-BG-L	For wall mounting	90
[8] Push-in fittings	QS	For connecting compressed air tubing with standard O.D.	90
[9] Silencer	UC	For fitting in exhaust ports	90

Datasheet – Individual valve

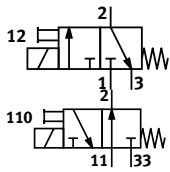
Function



-  - Voltage
24 V DC
-  - Pressure
-0.09 ... +0.8 MPa
-  - Temperature range
-5 ... +60°C



General technical data

Valve function	3/2 way, single solenoid ¹⁾
Design	Pressure relief poppet valve
Overlap	Negative overlap
Sealing principle	Soft
Reset method	Mechanical spring
Actuation type	Electrical
Type of control	Direct
Direction of flow	Reversible with restrictions ²⁾
Exhaust function	Can be throttled
Manual override	Non-detenting
Mounting position	Any
Width	[mm] 18
Grid dimension	[mm] 24
Note on grid dimension	Minimum distance between the valves is 6 mm
Nominal width	[mm] 4
Standard nominal flow rate	[l/min] 400
Type of mounting	Via through-hole
Pneumatic connection	Connecting thread G1/4
	Push-in connector for tubing O.D. 8 mm
Product weight	[g] 270

- 1) Can be used as a 2/2-way valve by sealing port 3 or 33
- 2) Slight leakage can occur in the pressure range -0.8 bar to +0.5 bar.

Operating and environmental conditions

		With fast-switching electronics	Without fast-switching electronics
Operating medium		Compressed air to ISO 8573-1:2010 [7:4:4]	
Note on the operating/pilot medium		Lubricated operation possible (in which case lubricated operation will always be required)	
Operating pressure	[MPa]	-0.09 ... +0.8	
	[bar]	-0.9 ... +8	
	Reversible [MPa]	-0.09 ... +0.1	
	[bar]	-0.9 ... +1	
	[psi]	-13.05 ... +14.5	
Ambient temperature	[°C]	-5 ... +60	
Temperature of medium	[°C]	-5 ... +60	
Corrosion resistance class CRC ¹⁾		2	
CE marking (see declaration of conformity) ³⁾		To EU EMC Directive ²⁾	-
		To EU RoHS Directive	-
UKCA marking (see declaration of conformity) ³⁾		To UK instructions for EMC	-
		To UK RoHS instructions	-
Certification		c UL us - Recognized (OL)	c UL us - Recognized (OL)
		RCM	-
Cleanroom class		Class 6 to ISO 14644-1	
Shock resistance		Shock test with severity level 2 to FN 942017-5 and EN 60068-2-27	
Vibration resistance		Transport application test with severity level 2 to FN 942017-4 and EN 60068-2-6	

- 1) More information: www.festo.com/x/topic/kbk
- 2) For information about the area of use, see the EC declaration of conformity at: www.festo.com/catalogue/... → Support/Downloads.
If the devices are subject to usage restrictions in residential, commercial or light-industrial environments, further measures for the reduction of the emitted interference may be necessary.
- 3) More information: www.festo.com/catalogue/... → Support/Downloads.

Datasheet – Individual valve

Electrical data		With fast-switching electronics	Without fast-switching electronics
Electrical connection		2-pin plug or cable	
Operating voltage	[V DC]	24	
Permissible voltage fluctuations	[%]	±10	
Power consumption	[W]	8.5 (high-current phase)	5.6
	[W]	2.125 (low-current phase)	–
Reverse polarity protection		Bipolar	
Duty cycle	[%]	100	
Additional functions		Spark arresting	
		Holding current reduction	
		Protective circuit	
Degree of protection to EN 60529		IP65	IP65

Switching times and frequencies				With fast-switching electronics	Without fast-switching electronics
Switching time	On	[ms]		3.5	10.5
	Off	[ms]		3.5	5
Tolerance for switching time	On	[%]		+10 ... -30	–
	Off	[%]		+10 ... -40	–
Switching time variation from 1 Hz upwards		[ms]		0.3	–
Maximum switching frequency		[Hz]		210	120

Materials	
Housing	Coated die-cast zinc
Cable sheath	PUR
Seals	HNBR, NBR
Screws	Galvanised steel
Note on materials	RoHS-compliant
PWIS conformity	VDMA24364-B1/B2-L

Current curve for valves with fast-switching electronics (MHE4-MS1H)

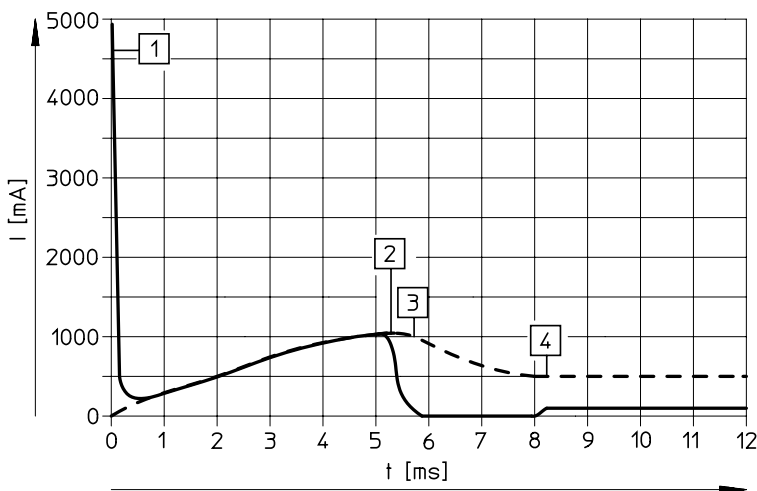

- [1] Capacitor charging
- [2] Controlled coil current 1 A
- [3] Holding current reduction
- [4] Controlled holding current 0.5 A

----- Internal current in the coil
 — External current in the supply line

Datasheet – Individual valve

Dimensions

Download CAD data → www.festo.com

Valve with plug vanes or moulded-in cable

MHE4-...-G-1/4

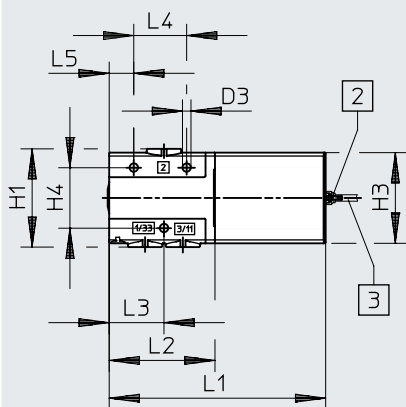
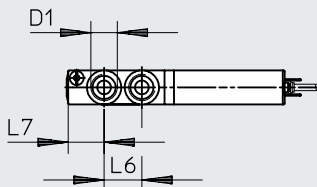

MHE4-...-QS-8

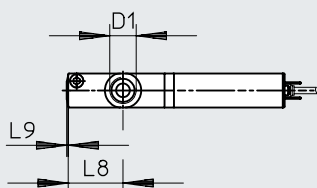
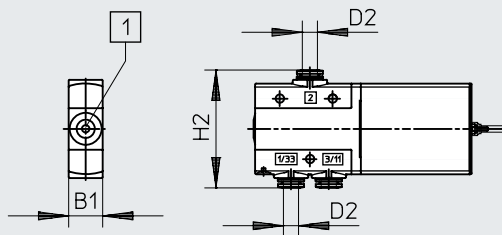

[1] Manual override, non-detenting

[2] Plug vanes

[3] Cable, 2.5 m

Type	B1	D1	D2 ∅	D3 ∅	H1	H2	H3	H4	L1	L2	L3	L4	L5	L6	L7	L8	L9
MHE4-...-1/4-...	18	G1/4	-	4.5	56	-	48	32	114.6	56	29	28	13	20	19	29	0.8
MHE4-...-QS-8-...	18	-	8	4.5	52	62.4	48	32	114.6	56	29	28	13	20	19	29	0.8

Datasheet – Individual valve

Dimensions

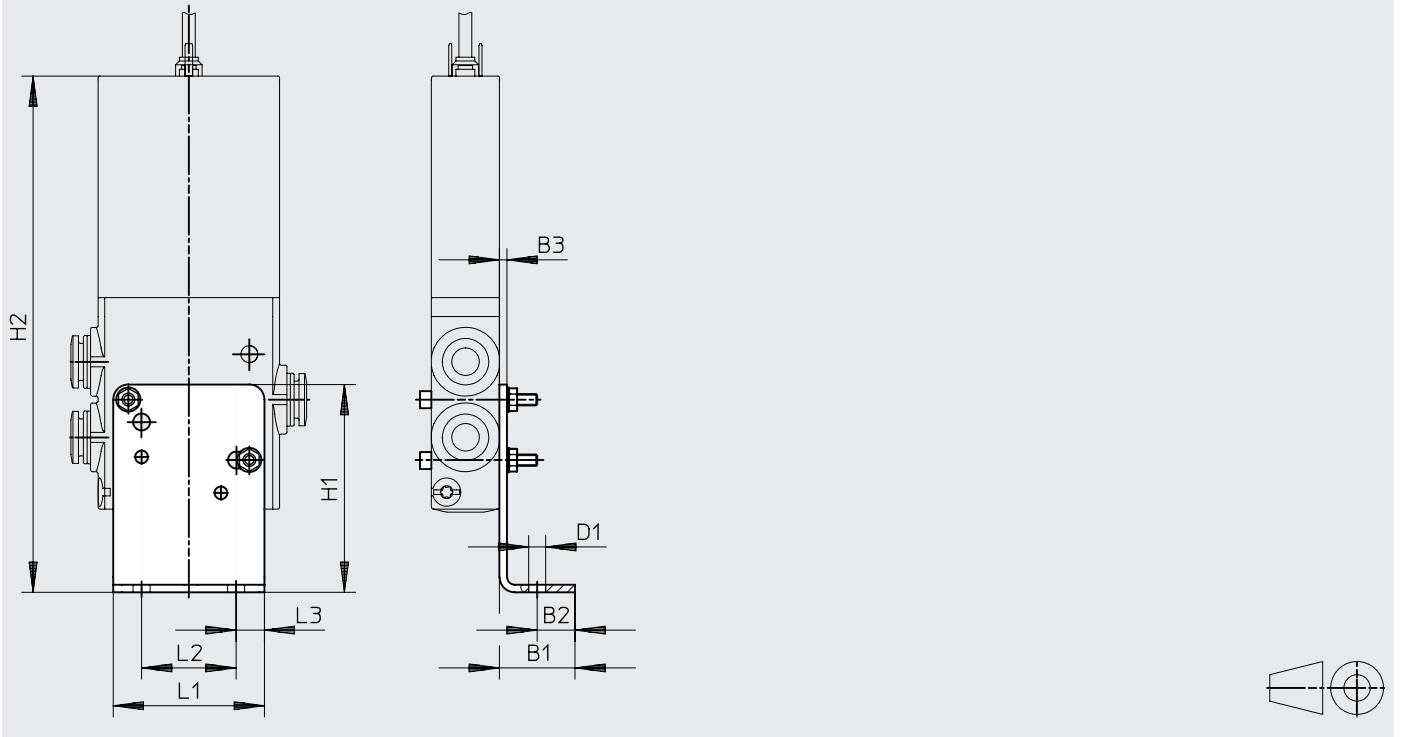

Download CAD data → www.festo.com

Mounting bracket MHE2-BG-L









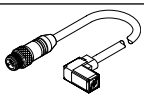

Type	B1	B2	B3	D1	H1	H2	L1	L2	L3
MHE2-BG-L	20	10	2	4.5	55	134	40	25	7.5

Datasheet – Individual valve

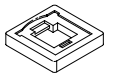
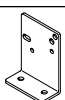
Ordering data					Part no.	Type
Valves						
	Electrical connection: 2-pin plug	With fast-switching electronics, switching time 3.5 ms	Pneumatic connection: thread G1/4	Normally open	525207	MHE4-MS1H-3/20-1/4
				Normally closed	525187	MHE4-MS1H-3/2G-1/4
			Pneumatic connection: push-in connector for tubing O.D. 8 mm	Normally open	525211	MHE4-MS1H-3/20-QS-8
				Normally closed	525191	MHE4-MS1H-3/2G-QS-8
		Without fast-switching electronics, switching time 10.5 ms	Pneumatic connection: thread G1/4	Normally open	525206	MHE4-M1H-3/20-1/4
				Normally closed	525186	MHE4-M1H-3/2G-1/4
			Pneumatic connection: push-in connector for tubing O.D. 8 mm	Normally open	525210	MHE4-M1H-3/20-QS-8
				Normally closed	525190	MHE4-M1H-3/2G-QS-8
	Electrical connection: cable	With fast-switching electronics, switching time 3.5 ms	Pneumatic connection: thread G1/4	Normally closed	525189	MHE4-MS1H-3/2G-1/4-K
			Pneumatic connection: push-in connector for tubing O.D. 8 mm	Normally open	525213	MHE4-MS1H-3/20-QS-8-K
				Normally closed	525193	MHE4-MS1H-3/2G-QS-8-K
			Without fast-switching electronics, switching time 10.5 ms	Pneumatic connection: thread G1/4	Normally open	525208
		Normally closed			525188	MHE4-M1H-3/2G-1/4-K

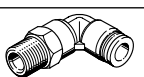
Datasheet – Individual valve

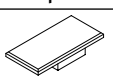
Ordering data				Part no.	Type			
Plug socket with cable (for valves with 2-pin plug)								
	3-pin socket, open cable end 3-wire Signal status indication with LED	PVC cable, degree of protection IP65	Length 2.5 m	151688	KMEB-1-24-2.5-LED			
			Length 5 m	151689	KMEB-1-24-5-LED			
			Length 10 m	193457	KMEB-1-24-10-LED			
	4-pin socket, open cable end 3-wire Signal status indication with LED	PUR cable, degree of protection IP65	Length 2.5 m	174844	KMEB-2-24-2.5-LED			
			Length 5 m	174845	KMEB-2-24-5-LED			
	5-pin socket, plug M12 5-pin Signal status indication with LED	Cable sheath TPE-U (PU), degree of protection IP65	Length 0.5 m	177677	KMEB-2-24-M12-0.5-LED			
Plug socket (for valves with 2-pin plug)								
	Angled socket Without signal status indication	Screw terminal Degree of protection IP65	3-pin	151687	MSSD-EB			
		Insulation displacement technology Degree of protection IP67	4-pin	192745	MSSD-EB-S-M14			
Illuminating seal								
	For mounting between plug socket (without signal status indication) and valve			151717	MEB-LD-12-24DC			
Wall mounting								
	Mounting bracket			196165	MHE2-BG-L			
Silencer Datasheets → Internet: uc								
	Push-in sleeve	Screwed trunnion PE	8 mm	1 piece	175611	UC-QS-8H		
	Threaded connection, polymer design	Screwed trunnion PE	G1/4	1 piece	165004	UC-1/4		
				20 pieces	534220	UC-1/4-20		
Push-in fitting Datasheets → Internet: qs								
	Male thread with external hex	G1/4	8 mm	10 pieces	186099	QS-G1/4-8		
				50 pieces	132040	QS-G1/4-8-50		
			10 mm	10 pieces	186101	QS-G1/4-10		
				50 pieces	132041	QS-G1/4-10-50		
	Push-in L-fitting, rotatable through 360°, male thread with external hex	G1/4	8 mm	10 pieces	186120	QSL-G1/4-8		
				50 pieces	132052	QSL-G1/4-8-50		
			10 mm	10 pieces	186122	QSL-G1/4-10		
				50 pieces	132053	QSL-G1/4-10-50		
			Blanking plug					
				For thread G1/4			10 pieces	3569
Inscription label								
	For solenoid valve			80 pieces	197259	MH-BZ-80X		

Peripherals overview – Semi in-line valve

Connection via plug vanes

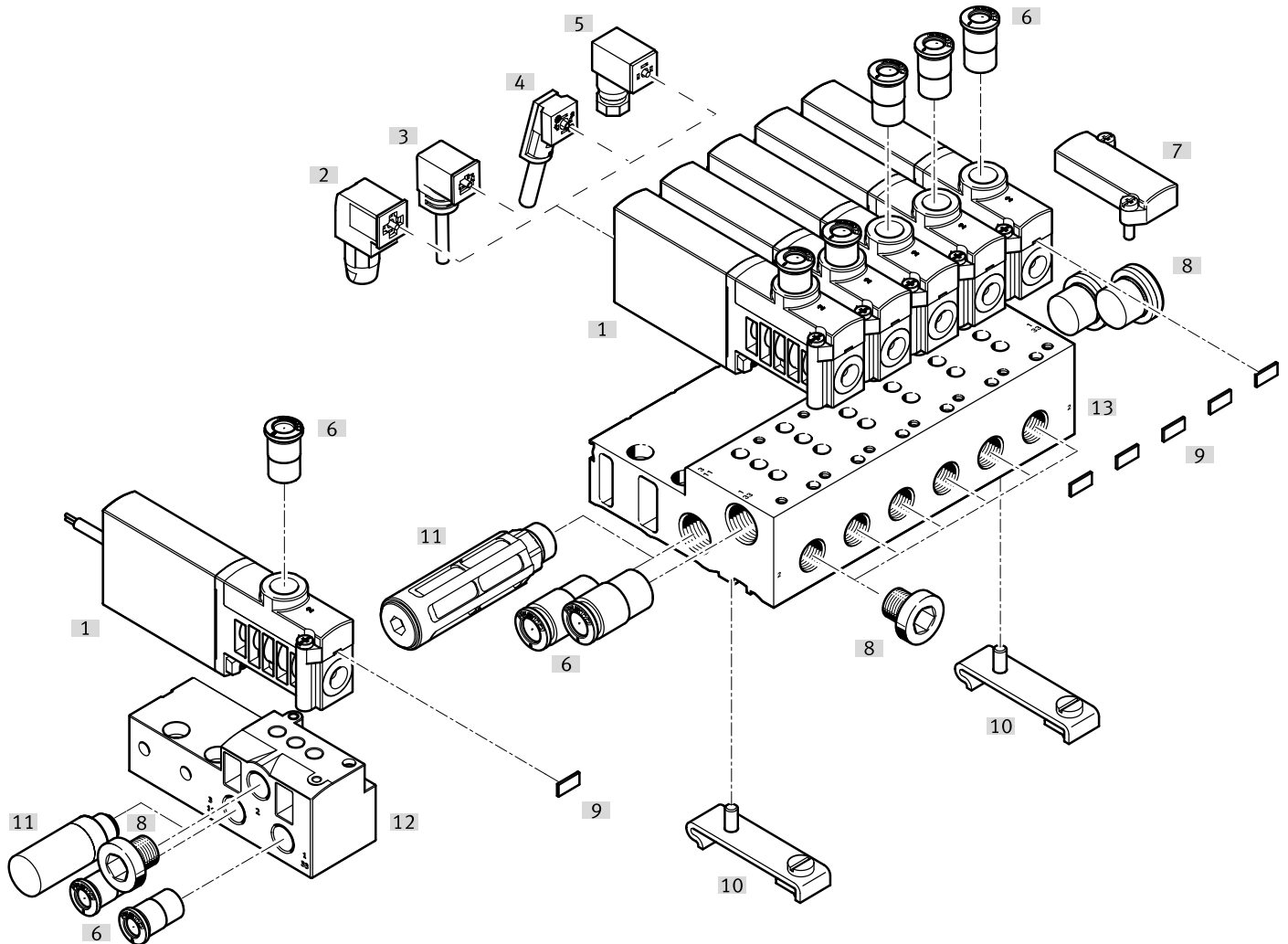



Designation	Type	Description	→ Page/Internet
[1] Semi in-line valve	MHP4	With plug vanes	92
[2] Plug socket with cable	KMEB-2	PUR cable, with or without LED	98
[3] Plug socket	MSSD-EB	With clamping screw	98
[4] Plug socket	MSSD-EB-S-M14	With insulation displacement connector	98
[5] Plug socket with cable	KMEB-1	PVC cable, with or without LED	98
[6] Push-in fittings	QS	For connecting compressed air tubing with standard O.D.	99
[7] Cover plate	MHAP4-BP-3	For sealing vacant positions	97
[8] Blanking plug	B	For sealing unused ports	99
[9] Inscription label	MH-BZ-80X	For identifying the valves	99
[10] H-rail mounting	CPV10/14-VI-BG-NRH-35	For mounting the manifold block on H-rails to EN 60715	98
[11] Silencers	UC	For fitting in exhaust ports	99
[12] Individual sub-base	MHA4-AS-3-1/4	For semi in-line valves; the individual sub-base is also used for sub-base valves; the extra connection must be sealed with a plug here	97
[13] Manifold block	MHA4-PR...-1/4	For semi in-line valves	97

Datasheet – Semi in-line valve

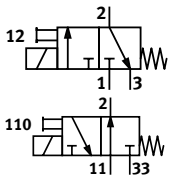
Function



-  - Voltage
24 V DC
-  - Pressure
-0.09 ... +0.8 MPa
-  - Temperature range
-5 ... +40°C



General technical data

Valve function	3/2 way, single solenoid ¹⁾	
Design	Pressure relief poppet valve	
Overlap	Negative overlap	
Sealing principle	Soft	
Reset method	Mechanical spring	
Actuation type	Electrical	
Type of control	Direct	
Direction of flow	Reversible with restrictions ²⁾	
Exhaust function	Can be throttled	
Manual override	Non-detenting	
Mounting position	Any	
Width	[mm]	18
Grid dimension	[mm]	24
Note on grid dimension	Minimum distance between the valves is 6 mm	
Nominal width	[mm]	4
Standard nominal flow rate	[l/min]	400
Type of mounting	On PR rail	
Pneumatic connection	2	Connecting thread G1/4, push-in connector for tubing O.D. 8 mm
	1, 11, 3, 33	Sub-base
Product weight	[g]	270

1) Can be used as a 2/2-way valve by sealing port 3 or 33
 2) Slight leakage can occur in the pressure range -0.8 bar to +0.5 bar.

Datasheet – Semi in-line valve

Operating and environmental conditions		With fast-switching electronics	Without fast-switching electronics	
Operating medium		Compressed air to ISO 8573-1:2010 [7:4:4]		
Note on the operating/pilot medium		Lubricated operation possible (in which case lubricated operation will always be required)		
Operating pressure	[MPa]	-0.09 ... +0.8		
	[bar]	-0.9 ... +8		
	Reversible	[MPa]	-0.09 ... +0.1	
		[bar]	-0.9 ... +1	
	[psi]	-13.05 ... +14.5		
Ambient temperature		[°C] -5 ... +40		
Temperature of medium		[°C] -5 ... +40		
Corrosion resistance class CRC ¹⁾		2		
CE marking (see declaration of conformity) ³⁾		To EU EMC Directive ²⁾	-	
		To EU RoHS Directive	-	
UKCA marking (see declaration of conformity) ³⁾		To UK instructions for EMC	-	
		To UK RoHS instructions	-	
Certification		c UL us - Recognized (OL)	c UL us - Recognized (OL)	
		RCM	-	
Cleanroom class		Class 6 to ISO 14644-1		
Shock resistance		Shock test with severity level 2 to FN 942017-5 and EN 60068-2-27		
Vibration resistance		Transport application test with severity level 2 to FN 942017-4 and EN 60068-2-6		

1) More information: www.festo.com/x/topic/kbk

2) For information about the area of use, see the EC declaration of conformity at: www.festo.com/catalogue/mh2 → Support/Downloads.

If the devices are subject to usage restrictions in residential, commercial or light-industrial environments, further measures for the reduction of the emitted interference may be necessary.

3) More information: www.festo.com/catalogue/... → Support/Downloads.

Electrical data		With fast-switching electronics	Without fast-switching electronics
Electrical connection		Plug, 2-pin	
Operating voltage	[V DC]	24	
Permissible voltage fluctuations	[%]	±10	
Power consumption	[W]	8.5 (high-current phase)	5.6
	[W]	2.125 (low-current phase)	-
Reverse polarity protection		Bipolar	
Duty cycle	[%]	100	100
Additional functions		Spark arresting	-
		Holding current reduction	-
		Protective circuit	-
Degree of protection to EN 60529		IP65	IP65

Switching times and frequencies		With fast-switching electronics	Without fast-switching electronics
Switching time	On [ms]	3.5	10.5
	Off [ms]	3.5	5
Tolerance for switching time	On [%]	+10 ... -30	-
	Off [%]	+10 ... -40	-
Switching time variation from 1 Hz upwards	[ms]	0.3	-
Maximum switching frequency	[Hz]	210	120

Materials	
Housing	Coated die-cast zinc
Seals	HNBR, NBR
Screws	Galvanised steel
Note on materials	RoHS-compliant
PWIS conformity	VDMA24364-B1/B2-L

Datasheet – Semi in-line valve

Current curve for valves with fast-switching electronics (MHP4-MS1H)

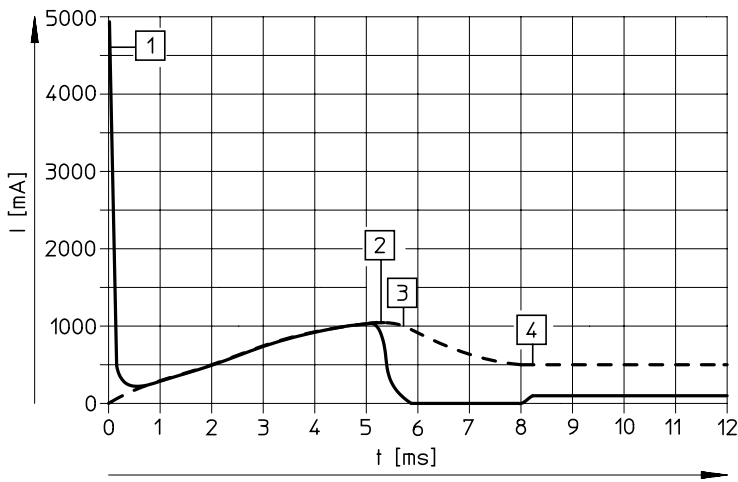

- [1] Capacitor charging
- [2] Controlled coil current 1 A
- [3] Holding current reduction
- [4] Controlled holding current 0.5 A

----- Internal current in the coil
 ——— External current in the supply line

Dimensions

Download CAD data → www.festo.com

Valve with connecting thread G1/4

Valve with push-in connector for tubing O.D. 8 mm

MHP4-...-G1/4

MHP4-...-QS8

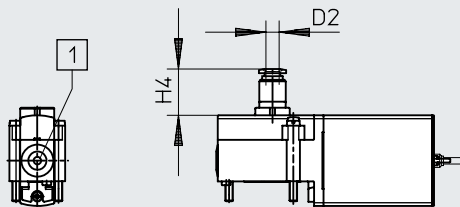
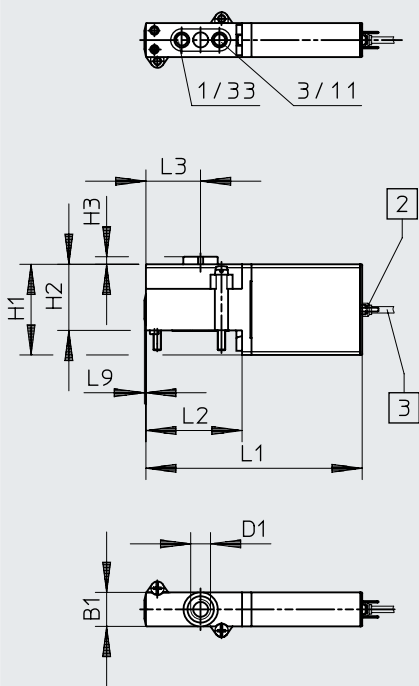

- [1] Manual override, non-detenting
- [2] Plug vanes

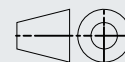

Type	B1	D1	D2 ø	H1	H2	H3	H4	L1	L2	L3	L9
MHP4-...-3/2...	18	G1/4	8	48	35	4	24.5	114.6	51	29	0.8

Datasheet – Semi in-line valve

Dimensions

Download CAD data → www.festo.com

Hole pattern on sub-bases

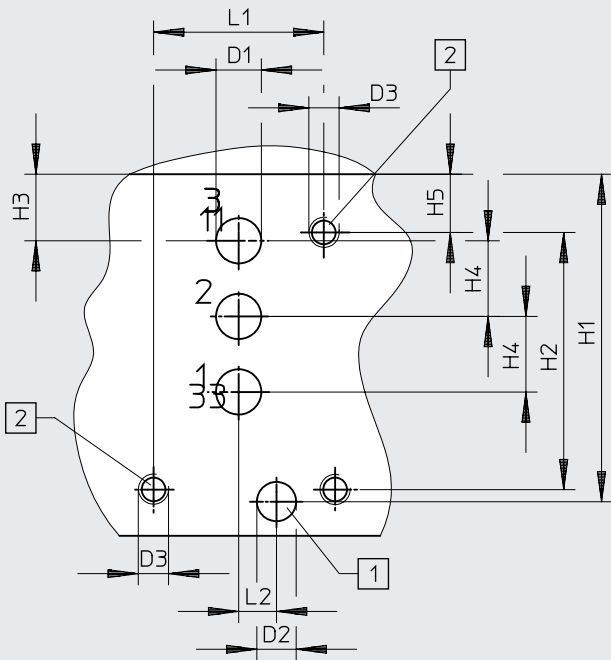

- [1] Hole for coding pin, 2.5mm deep
- [2] Mounting thread, 13 mm deep

Note

With semi in-line valves, port 2 is not used.
 If used as a 2/2-way valve, normally closed, ports 3/11 are not used.
 If used as a 2/2-way valve, normally open, ports 1/33 are not used.

Individual sub-base, MHA4-AS-3-1/4

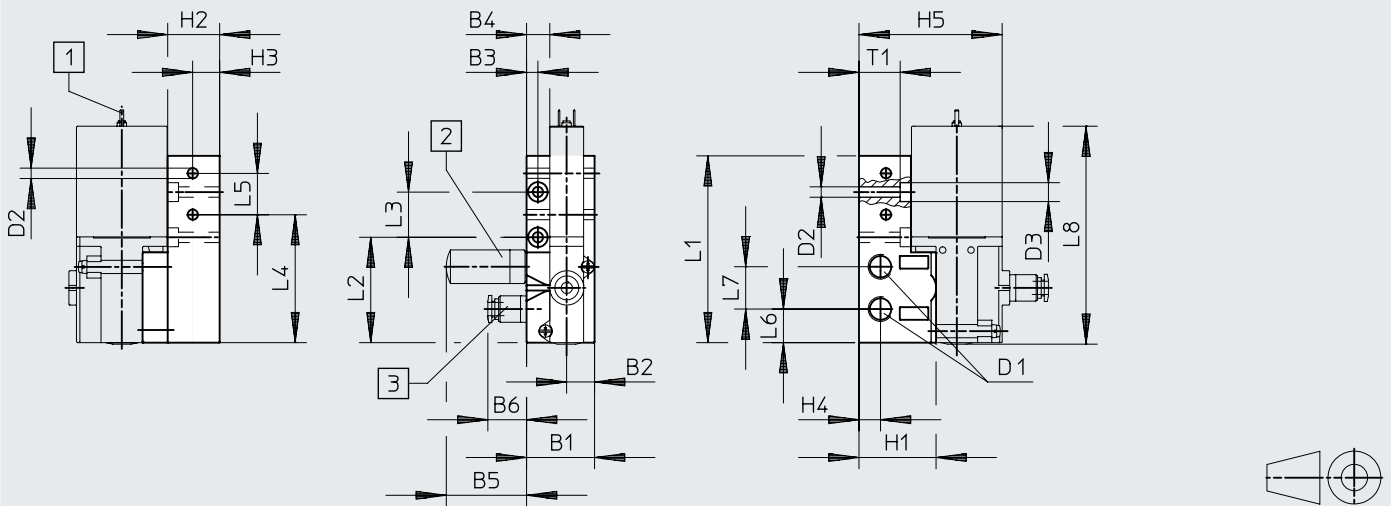

- [1] Plug vanes
- [2] Silencer
- [3] Push-in fitting

Type	B1	B2	B3	B4	B5	B6	D1	D2 ø	D3 ø	H1	H2	H3	H4	H5
Hole pattern	-	-	-	-	-	-	6	5.2	M4	43.3	34	8.8	10	7.7
MHA4-AS-3-1/4	36	14.8	6	12.3	42.5	20.5	G1/4	5.5	10	31	27.5	14.3	11.4	75.8

Type	L1	L2	L3	L4	L5	L6	L7	L8	T1
Hole pattern	22.5	5	-	-	-	-	-	-	-
MHA4-AS-3-1/4	99	55.8	24	67.8	21.9	17.8	22.4	115.4	21.8

Datasheet – Semi in-line valve

Dimensions

Download CAD data → www.festo.com

Manifold assembly, MHA4-PR...-1/4

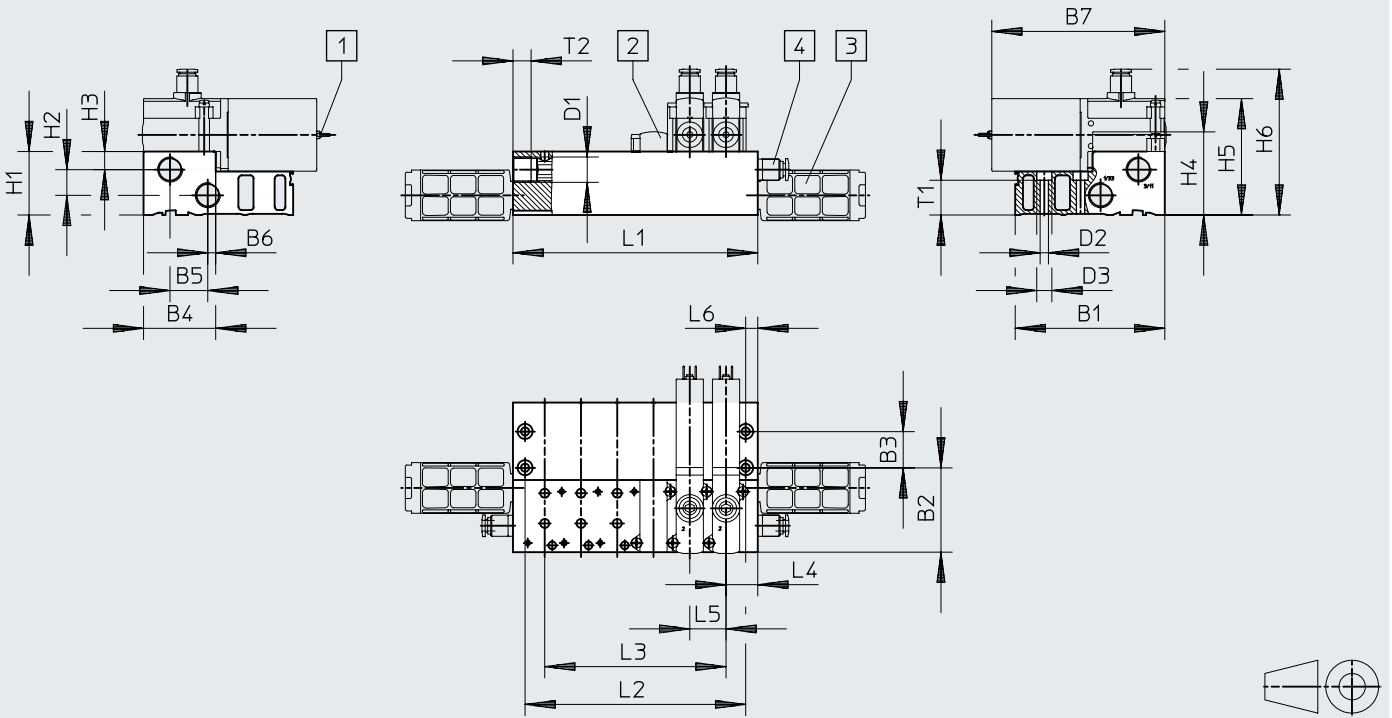

[1] Plug vanes [2] Cover plate [3] Silencer [4] Push-in fitting

H-rail mounting CPV1 0/14-VI-BG-NRH-35

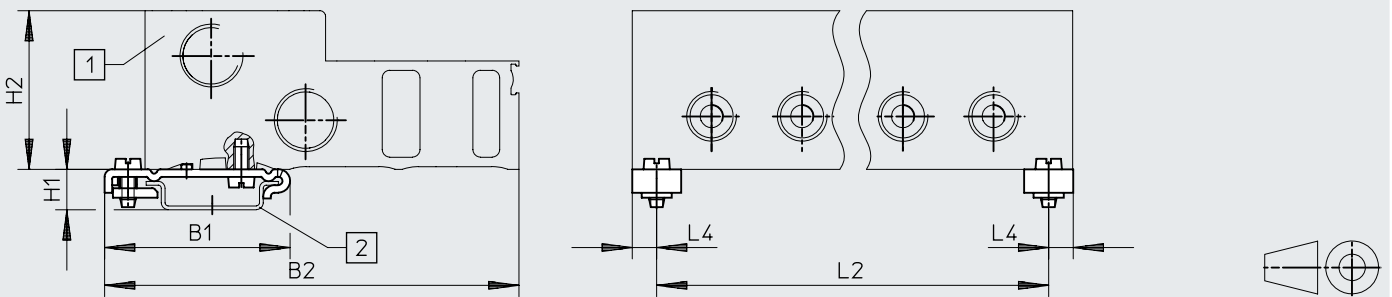





[1] Manifold block [2] DIN mounting rail

Type	B1	B2	B3	B4	B5	B6	B7	D1	D2 ∅	D3 ∅	H1	H2	H3	H4	H5	H6	L4	L5	L6	T1	T2
MHA4-PR...-1/4	99	55.8	24	47.8	25	5.3	114.6	G3/8	5.5	10	42	17	12	55	77	96.5	21	24	8	23	12
CPV1 0/14-VI-BG...	49.1	110	-	-	-	-	-	-	-	-	10.7	42	-	-	-	-	6.5	-	-	-	-

Type	Number of valve positions					
	2	4	6	8	10	
MHA4-PR...-1/4	L1	66	114	162	210	258
	L2	50	98	146	194	242
	L3	24	72	120	168	216
CPV1 0/14-VI-BG...	L2	53	101	149	197	245

Note
Valve types 3/2G and 3/2O must not be mixed on one manifold block.

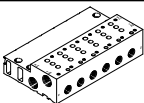
Datasheet – Semi in-line valve







Ordering data				Part no.	Type	
Valves						
	Electrical connection: 2-pin plug	With fast-switching electronics, switching time 3.5 ms	Pneumatic connection: thread G1/4	Normally open	525199	MHP4-MS1H-3/20-1/4
				Normally closed	525179	MHP4-MS1H-3/2G-1/4
			Pneumatic connection: push-in connector for tubing O.D. 8 mm	Normally closed	525183	MHP4-MS1H-3/2G-QS-8
		Without fast-switching electronics, switching time 10.5 ms	Pneumatic connection: thread G1/4	Normally open	525198	MHP4-M1H-3/20-1/4
			Normally closed	525178	MHP4-M1H-3/2G-1/4	
Manifold rail						
	Individual sub-base ¹⁾ Pneumatic connection: thread G1/4		1 valve position	525227	MHA4-AS-3-1/4	
	Manifold block ¹⁾ Pneumatic connection 1, 11, 3, 33: thread G3/8 Pneumatic connection 2: thread G1/4		2 valve positions	525234	MHA4-PR2-3-1/4	
			4 valve positions	525235	MHA4-PR4-3-1/4	
			6 valve positions	525236	MHA4-PR6-3-1/4	
			8 valve positions	525237	MHA4-PR8-3-1/4	
			10 valve positions	525238	MHA4-PR10-3-1/4	
Cover plate						
	Vacant valve positions must be sealed with a cover plate.			525239	MHAP4-BP-3	

1) Seal port 2 with a blanking plug. These ports have no function when using semi in-line valves.



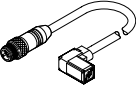

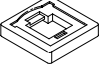
 **Note**

Valve types 3/2G and 3/20 must not be mixed on one manifold block.

Datasheet – Semi in-line valve

Ordering data				Part no.	Type
Plug socket with cable					
	3-pin socket, open cable end 3-wire Signal status indication with LED	PVC cable, degree of protection IP65	Length 2.5 m	151688	KMEB-1-24-2.5-LED
			Length 5 m	151689	KMEB-1-24-5-LED
			Length 10 m	193457	KMEB-1-24-10-LED
	4-pin socket, open cable end 3-wire Signal status indication with LED	PUR cable, degree of protection IP65	Length 2.5 m	174844	KMEB-2-24-2.5-LED
			Length 5 m	174845	KMEB-2-24-5-LED
	5-pin socket, plug M12 5-pin Signal status indication with LED	Cable sheath TPE-U (PU), degree of protection IP65	Length 0.5 m	177677	KMEB-2-24-M12-0.5-LED
Plug socket					
	Angled socket Without signal status indication	Screw terminal Degree of protection IP65	3-pin	151687	MSSD-EB
		Insulation displacement technology Degree of protection IP67	4-pin	192745	MSSD-EB-S-M14
Illuminating seal					
	For mounting between plug socket (without signal status indication) and valve			151717	MEB-LD-12-24DC
H-rail mounting					
	For manifold block			162556	CPV10/14-VI-BG-NRH-35
H-rail					
	To EN 60715		2 m	35430	NRH-35-2000

Datasheet – Semi in-line valve

Ordering data					Part no.	Type
Silencer					Datasheets → Internet: uc	
	Push-in sleeve	Screwed trunnion PE	8 mm	1 piece	175611	UC-QS-8H
	Threaded connection, polymer design	Screwed trunnion PE	G1/4	1 piece	165004	UC-1/4
				20 pieces	534220	UC-1/4-20
		Housing Polyacetal	G3/8	1 piece	2309	U-3/8
			20 pieces	534224	U-3/8-20	
Push-in fitting					Datasheets → Internet: qs	
	Male thread with external hex	G1/4	8 mm	10 pieces	186099	QS-G1/4-8
				50 pieces	132040	QS-G1/4-8-50
			10 mm	10 pieces	186101	QS-G1/4-10
			50 pieces	132041	QS-G1/4-10-50	
		G3/8	10 mm	10 pieces	186102	QS-G3/8-10
				50 pieces	132044	QS-G3/8-10-50
12 mm	10 pieces		186103	QS-G3/8-12		
	20 pieces	132045	QS-G3/8-12-20			
	Push-in L-fitting, rotatable through 360°, male thread with external hex	G1/4	8 mm	10 pieces	186120	QSL-G1/4-8
				50 pieces	132052	QSL-G1/4-8-50
			10 mm	10 pieces	186122	QSL-G1/4-10
			50 pieces	132053	QSL-G1/4-10-50	
		G3/8	10 mm	10 pieces	186123	QSL-G3/8-10
				20 pieces	132056	QSL-G3/8-10-20
			12 mm	10 pieces	186124	QSL-G3/8-12
			20 pieces	132057	QSL-G3/8-12-20	
Blanking plug						
	For thread G1/4			10 pieces	3569	B-1/4
	For thread G3/8			10 pieces	3570	B-3/8
Inscription label						
	For solenoid valve			80 pieces	197259	MH-BZ-80X

Peripherals overview – Sub-base valve

Connection with plug vanes – Connection with moulded-in cable

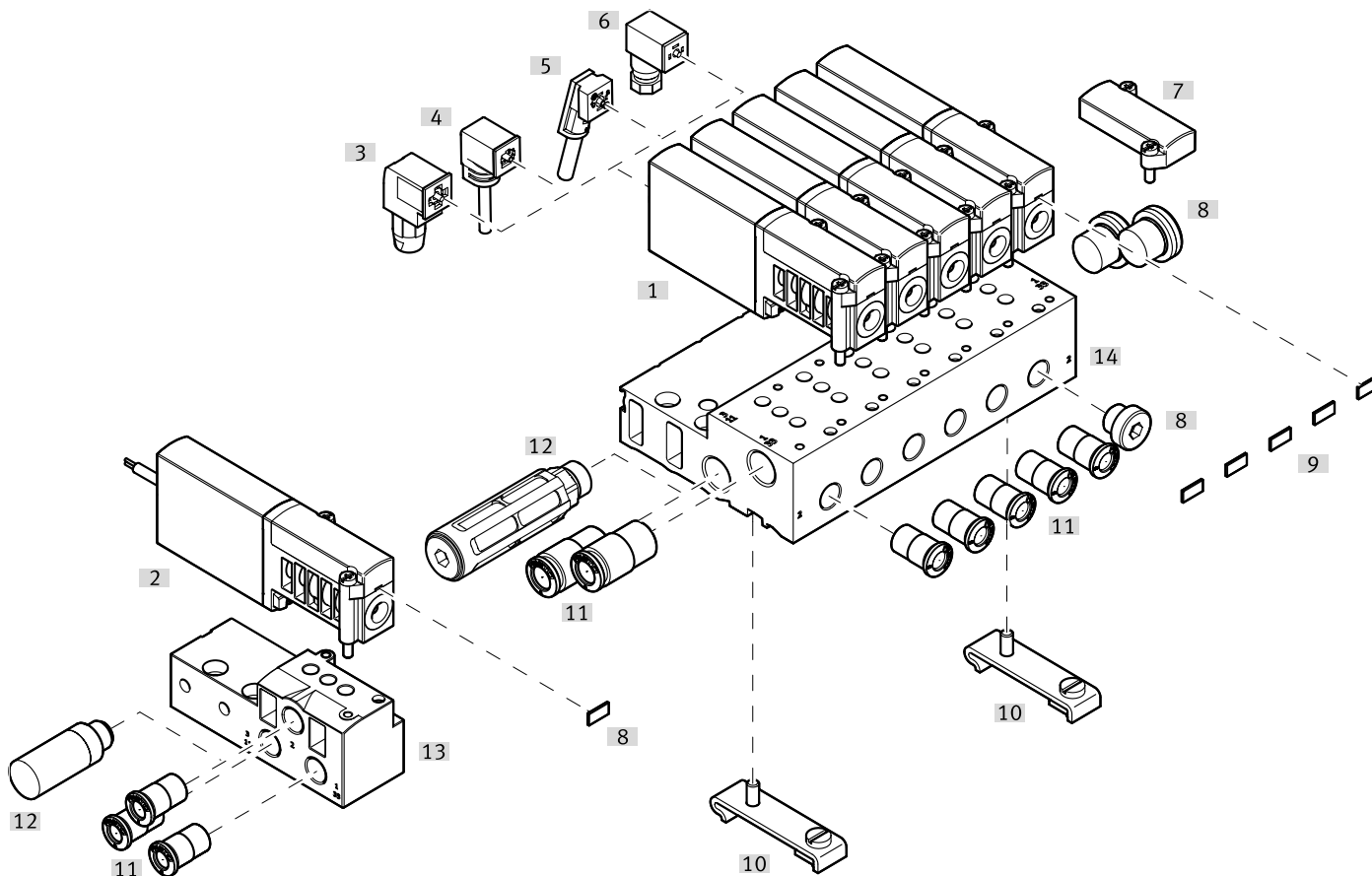

Designation	Type	Description	→ Page/Internet
[1] Sub-base valves	MHA4	With plug vanes	101
[2] Sub-base valves	MHA4-...-K	With moulded-in cable, IP65	107
[3] Plug socket	MSSD-EB-S-M14	With insulation displacement connector	108
[4] Plug socket with cable	KMEB-1	PVC cable, with or without LED	108
[5] Plug socket with cable	KMEB-2	PUR cable, with or without LED	108
[6] Plug socket	MSSD-EB	With clamping screw	108
[7] Cover plate	MHAP4-BP-3	For sealing vacant positions	107
[8] Blanking plug	B	For sealing unused ports	109
[9] Inscription label	MH-BZ-80X	For identifying the valves	109
[10] H-rail mounting	CPV10/14-VI-BG-NRH-35	For mounting the manifold block on H-rails to EN 60715	108
[11] Push-in fittings	QS	For connecting compressed air tubing with standard O.D.	109
[12] Silencer	UC	For fitting in exhaust ports	109
[13] Individual sub-base	MHA4-AS-3-1/4	For sub-base valves	107
[14] Manifold block	MHA4-PR-...-1/4	For sub-base valves	107

Datasheet – Sub-base valve

Function

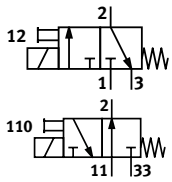

Voltage
24 V DC



Pressure
-0.09 ... +0.8 MPa



Temperature range
-5 ... +40°C



General technical data

Valve function	3/2 way, single solenoid ¹⁾
Design	Pressure relief poppet valve
Overlap	Negative overlap
Sealing principle	Soft
Reset method	Mechanical spring
Actuation type	Electrical
Type of control	Direct
Direction of flow	Reversible with restrictions ²⁾
Exhaust function	Can be throttled
Manual override	Non-detenting
Mounting position	Any
Width	[mm] 18
Grid dimension	[mm] 24
Note on grid dimension	Minimum distance between the valves is 6 mm
Nominal width	[mm] 4
Standard nominal flow rate	[l/min] 400
Type of mounting	On PR rail
Pneumatic connection	1, 11, 2, 3, 33
Product weight	[g] 270

1) Can be used as a 2/2-way valve by sealing port 3 or 33

2) Slight leakage can occur in the pressure range -0.8 bar to +0.5 bar.

Datasheet – Sub-base valve

Operating and environmental conditions		With fast-switching electronics	Without fast-switching electronics	
Operating medium		Compressed air to ISO 8573-1:2010 [7:4:4]		
Note on the operating/pilot medium		Lubricated operation possible (in which case lubricated operation will always be required)		
Operating pressure	[MPa]	-0.09 ... +0.8		
	[bar]	-0.9 ... +8		
	Reversible	[MPa]	-0.09 ... +1	
		[bar]	-0.9 ... +1	
	[psi]	-13.05 ... +14.5		
Ambient temperature		[°C] -5 ... +40		
Temperature of medium		[°C] -5 ... +40		
Corrosion resistance class CRC ¹⁾		2		
CE marking (see declaration of conformity) ³⁾		To EU EMC Directive ²⁾	-	
		To EU RoHS Directive	-	
UKCA marking (see declaration of conformity) ³⁾		To UK instructions for EMC	-	
		To UK RoHS instructions	-	
Certification		c UL us - Recognized (OL)	c UL us - Recognized (OL)	
		RCM	-	
Cleanroom class		Class 6 to ISO 14644-1		
Shock resistance		Shock test with severity level 2 to FN 942017-5 and EN 60068-2-27		
Vibration resistance		Transport application test with severity level 2 to FN 942017-4 and EN 60068-2-6		

1) More information: www.festo.com/x/topic/kbk

2) For information about the area of use, see the EC declaration of conformity at: www.festo.com/catalogue/mh2 → Support/Downloads.

If the devices are subject to usage restrictions in residential, commercial or light-industrial environments, further measures for the reduction of the emitted interference may be necessary.

3) More information: www.festo.com/catalogue/... → Support/Downloads.

Electrical data		With fast-switching electronics	Without fast-switching electronics
Electrical connection		2-pin plug or cable	
Operating voltage	[V DC]	24	
Permissible voltage fluctuations	[%]	±10	
Power consumption	[W]	8.5 (high-current phase)	5.6
	[W]	2.125 (low-current phase)	-
Reverse polarity protection		Bipolar	
Duty cycle	[%]	100	100
Additional functions		Spark arresting	-
		Holding current reduction	-
		Protective circuit	-
Degree of protection to EN 60529		IP65	IP65

Switching times and frequencies		With fast-switching electronics	Without fast-switching electronics
Switching time	On [ms]	3.5	10.5
	Off [ms]	3.5	5
Tolerance for switching time	On [%]	+10 ... -30	-
	Off [%]	+10 ... -40	-
Switching time variation from 1 Hz upwards	[ms]	0.3	-
Maximum switching frequency	[Hz]	210	120

Materials	
Housing	Coated die-cast zinc
Cable sheath	PUR
Seals	HNBR, NBR
Screws	Galvanised steel
Note on materials	RoHS-compliant
PWIS conformity	VDMA24364-B1/B2-L

Datasheet – Sub-base valve

Current curve for valves with fast-switching electronics (MHA4-MS1H)

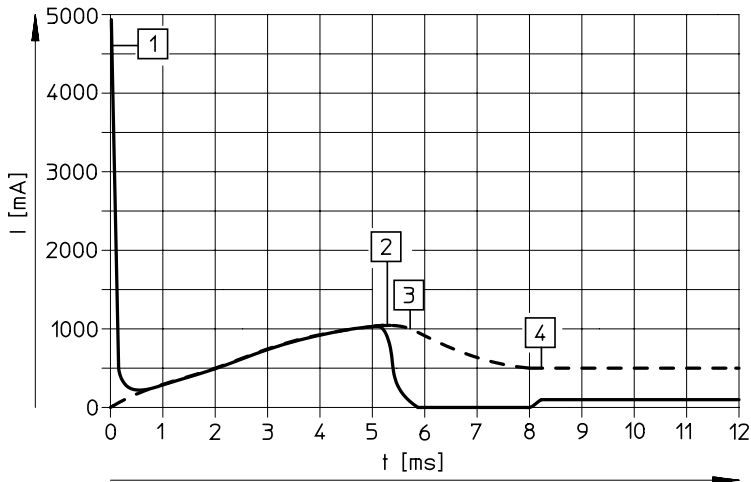

- [1] Capacitor charging
- [2] Controlled coil current 1 A
- [3] Holding current reduction
- [4] Controlled holding current 0.5 A

----- Internal current in the coil
 — External current in the supply line

Dimensions

Download CAD data → www.festo.com

Valve with plug vanes or moulded-in cable, MHA4-...-3/2...

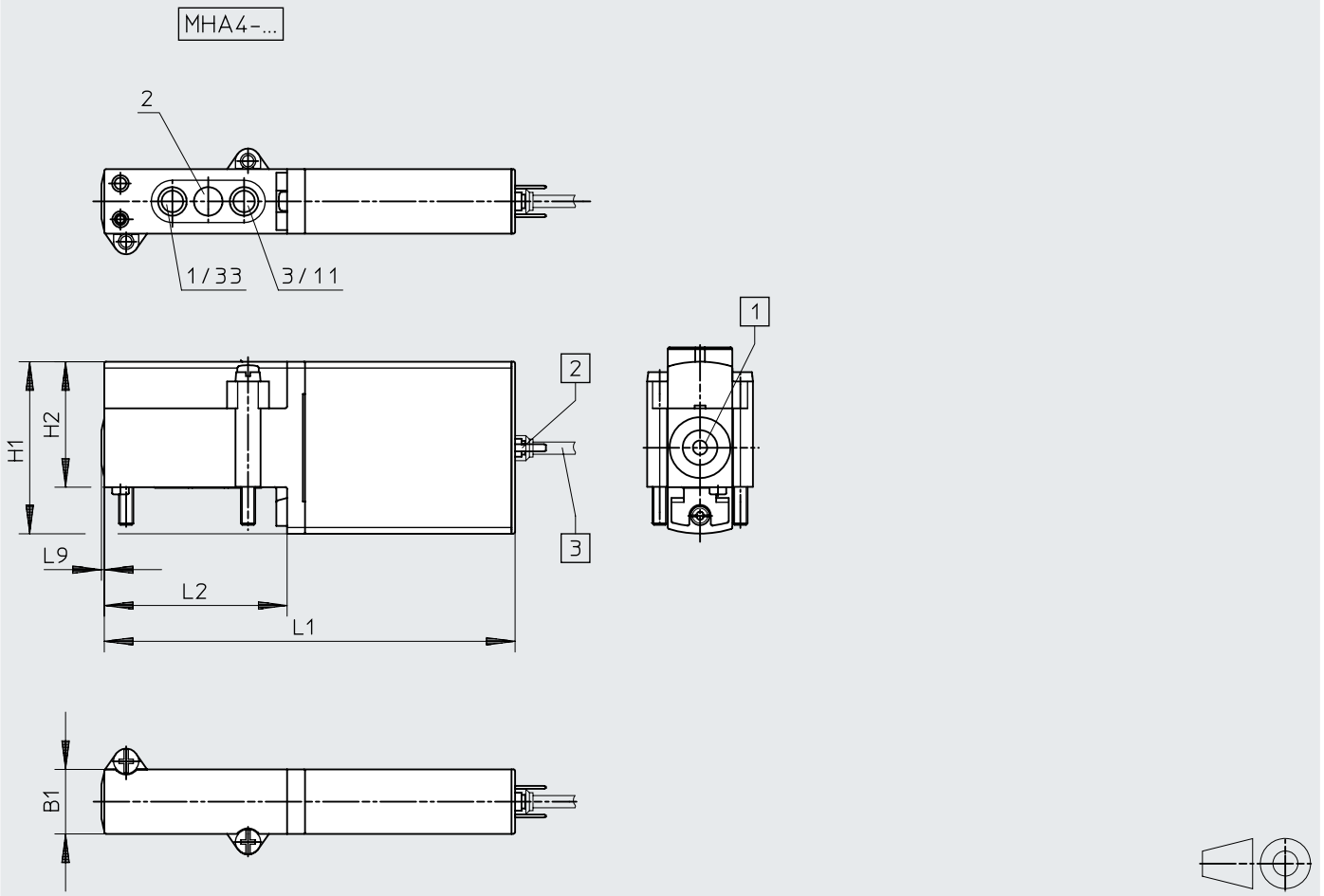

- [1] Manual override, non-detenting
- [2] Plug vanes
- [3] Cable, 2.5 m

Type	B1	H1	H2	L1	L2	L9
MHA4-...-3/2...	18	48	35	114.6	51	0.8

Datasheet – Sub-base valve

Dimensions

Download CAD data → www.festo.com

Hole pattern on sub-bases

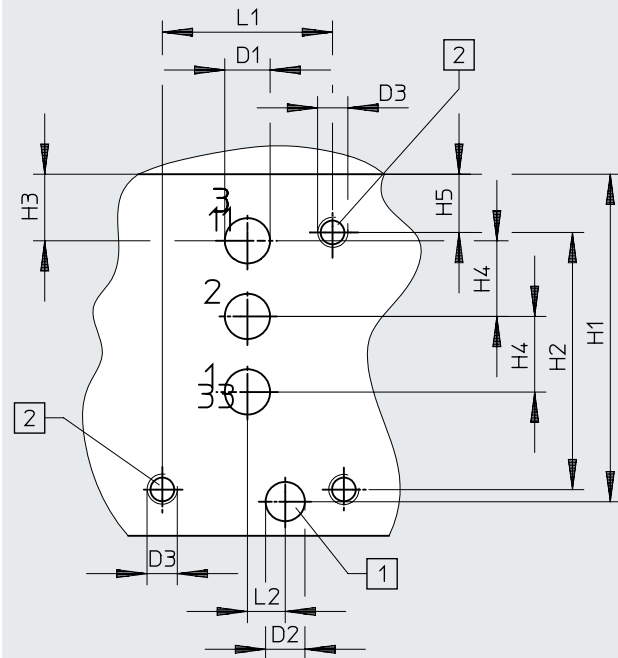

- [1] Hole for coding pin, 2.5mm deep
- [2] Mounting thread, 13 mm deep

Type	D1	D2 ∅	D3 ∅	H1	H2	H3	H4	H5	L1	L2
Hole pattern	6	5.2	M4	43.3	34	8.8	10	7.7	22.5	5

Datasheet – Sub-base valve

Dimensions

Download CAD data → www.festo.com

Individual sub-base, MHA4-AS-3-1/4

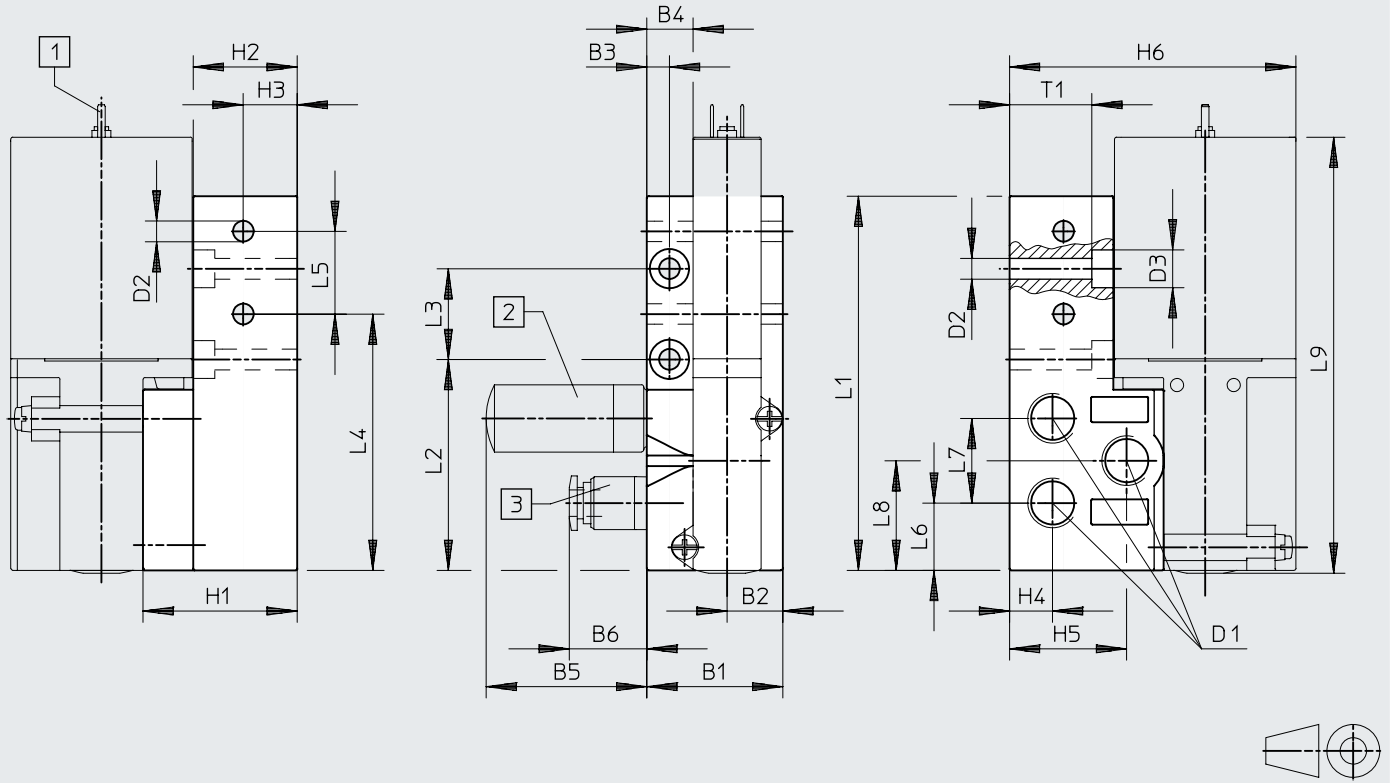

[1] Plug vanes

[2] Silencer

[3] Push-in fitting

Type	B1	B2	B3	B4	B5	B6	D1	D2 ∅	D3 ∅	H1	H2	H3	H4	H5	H6
MHA4-AS-3-1/4	36	14.8	6	12.3	42.5	20.5	G1/4	5.5	10	40.8	27.5	14.3	11.4	31	75.8

Type	L1	L2	L3	L4	L5	L6	L7	L8	L9	T1
MHA4-AS-3-1/4	99	55.8	24	67.8	21.9	17.8	22.4	29	115.4	21.8

Datasheet – Sub-base valve

Dimensions

Download CAD data → www.festo.com

Manifold assembly, MHA4-PR...-1/4

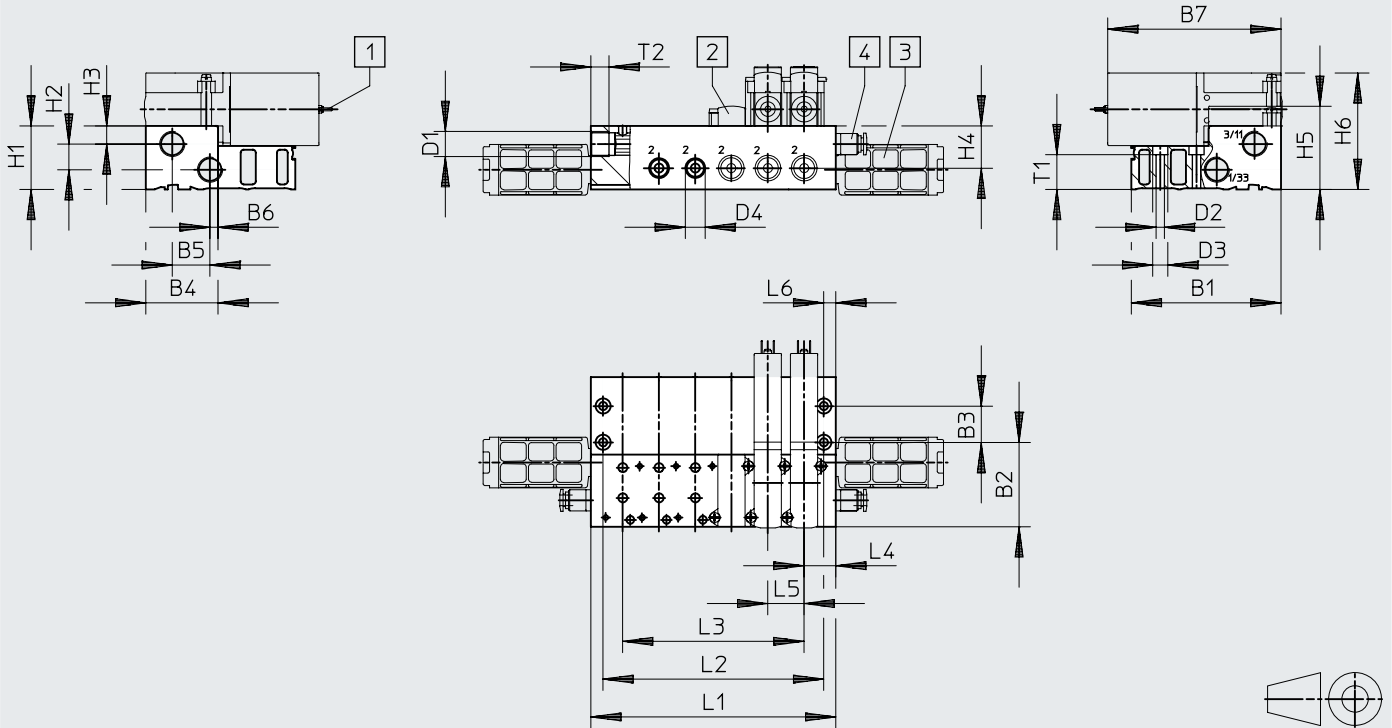

[1] Plug vanes or moulded-in cable [2] Cover plate [3] Silencer [4] Push-in fitting

H-rail mounting CPV1 0/14-VI-BG-NRH-35

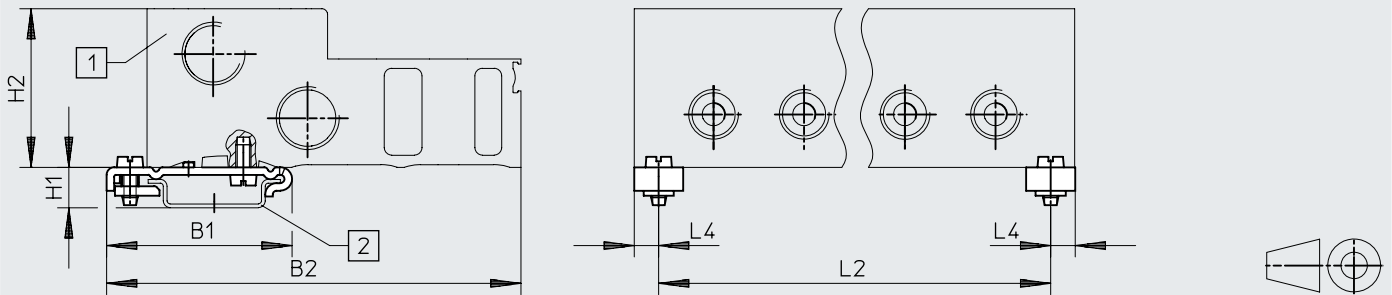





[1] Manifold block [2] DIN mounting rail

Type	B1	B2	B3	B4	B5	B6	B7	D1	D2 ∅	D3 ∅	D4 ∅	H1	H2	H3	H4	H5	H6
MHA4-PR...-1/4	99	55.8	24	47.8	25	5.3	114.6	G3/8	5.5	10	G1/4	42	17	12	28	55	77
CPV1 0/14-VI-BG...	49.1	110	-	-	-	-	-	-	-	-	-	10.7	42	-	-	-	-

Type	L4	L5	L6	T1	T2
MHA4-PR...-1/4	21	24	8	23	12
CPV1 0/14-VI-BG...	6.5	-	-	-	-

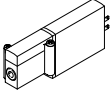
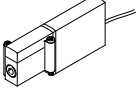
Type		Number of valve positions				
		2	4	6	8	10
MHA4-PR...-1/4	L1	66	114	162	210	258
	L2	50	98	146	194	242
	L3	24	72	120	168	216
CPV1 0/14-VI-BG...	L2	53	101	149	197	245

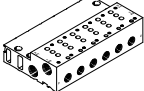





Datasheet – Sub-base valve

Ordering data			Part no.	Type	
Valves					
	Electrical connection: 2-pin plug	With fast-switching electronics, switching time 3.5 ms	Normally closed	525175	MHA4-MS1H-3/2G-4
		Without fast-switching electronics, switching time 10.5 ms	Normally closed	525174	MHA4-M1H-3/2G-4
	Electrical connection: cable	With fast-switching electronics, switching time 3.5 ms	Normally closed	525177	MHA4-MS1H-3/2G-4-K
		Without fast-switching electronics, switching time 10.5 ms	Normally open	525196	MHA4-M1H-3/20-4-K
			Normally closed	525176	MHA4-M1H-3/2G-4-K
Manifold rail					
	Individual sub-base Pneumatic connection: thread G1/4	1 valve position	525227	MHA4-AS-3-1/4	
	Manifold block Pneumatic connection 1, 11, 3, 33: thread G3/8 Pneumatic connection 2: thread G1/4	2 valve positions	525234	MHA4-PR2-3-1/4	
		4 valve positions	525235	MHA4-PR4-3-1/4	
		6 valve positions	525236	MHA4-PR6-3-1/4	
		8 valve positions	525237	MHA4-PR8-3-1/4	
		10 valve positions	525238	MHA4-PR10-3-1/4	
Cover plate					
	Vacant valve positions must be sealed with a cover plate.		525239	MHAP4-BP-3	



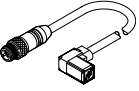

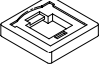
 **Note**

Valve types 3/2G and 3/2O must not be mixed on one manifold block.

Datasheet – Sub-base valve

Ordering data				Part no.	Type
Plug socket with cable (for valves with plug vanes)					
	3-pin socket, open cable end 3-wire Signal status indication with LED	PVC cable, degree of protection IP65	Length 2.5 m	151688	KMEB-1-24-2.5-LED
			Length 5 m	151689	KMEB-1-24-5-LED
			Length 10 m	193457	KMEB-1-24-10-LED
	4-pin socket, open cable end 3-wire Signal status indication with LED	PUR cable, degree of protection IP65	Length 2.5 m	174844	KMEB-2-24-2.5-LED
			Length 5 m	174845	KMEB-2-24-5-LED
	5-pin socket, plug M12 5-pin Signal status indication with LED	Cable sheath TPE-U (PU), degree of protection IP65	Length 0.5 m	177677	KMEB-2-24-M12-0.5-LED
Plug socket (for valves with plug vanes)					
	Angled socket Without signal status indication	Screw terminal Degree of protection IP65	3-pin	151687	MSSD-EB
		Insulation displacement technology Degree of protection IP67	4-pin	192745	MSSD-EB-S-M14
Illuminating seal					
	For mounting between plug socket (without signal status indication) and valve			151717	MEB-LD-12-24DC
H-rail mounting					
	For manifold block			162556	CPV10/14-VI-BG-NRH-35
H-rail					
	To EN 60715		2 m	35430	NRH-35-2000

Datasheet – Sub-base valve

Ordering data					Part no.	Type
Silencer Datasheets → Internet: uc						
	Push-in sleeve	Screwed trunnion PE	8 mm	1 piece	175611	UC-QS-8H
	Threaded connection, polymer design	Screwed trunnion PE	G1/4	1 piece	165004	UC-1/4
				20 pieces	534220	UC-1/4-20
		Housing POM	G3/8	1 piece	2309	U-3/8
			20 pieces	534224	U-3/8-20	
Push-in fitting Datasheets → Internet: qs						
	Male thread with external hex	G1/4	8 mm	10 pieces	186099	QS-G1/4-8
				50 pieces	132040	QS-G1/4-8-50
			10 mm	10 pieces	186101	QS-G1/4-10
			50 pieces	132041	QS-G1/4-10-50	
		G3/8	10 mm	10 pieces	186102	QS-G3/8-10
				50 pieces	132044	QS-G3/8-10-50
12 mm	10 pieces		186103	QS-G3/8-12		
	20 pieces	132045	QS-G3/8-12-20			
	Push-in L-fitting, rotatable through 360°, male thread with external hex	G1/4	8 mm	10 pieces	186120	QSL-G1/4-8
				50 pieces	132052	QSL-G1/4-8-50
			10 mm	10 pieces	186122	QSL-G1/4-10
			50 pieces	132053	QSL-G1/4-10-50	
		G3/8	10 mm	10 pieces	186123	QSL-G3/8-10
				20 pieces	132056	QSL-G3/8-10-20
			12 mm	10 pieces	186124	QSL-G3/8-12
			20 pieces	132057	QSL-G3/8-12-20	
Blanking plug						
	For thread G1/4			10 pieces	3569	B-1/4
	For thread G3/8			10 pieces	3570	B-3/8
Inscription label						
	For solenoid valve			80 pieces	197259	MH-BZ-80X