

## Zaolejovače LOE, konštrukčný rad D

**FESTO**



# Zaolejovače LOE, rad D, kovové

prehľad dodávok jednotiek úpravy vzduchu radu D, kov

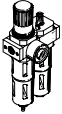
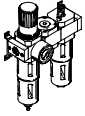
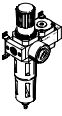
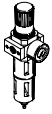
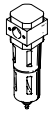
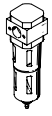
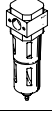
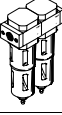
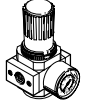

typ	veľkosť	pneumatický prípoj										rozsah regulačného tlaku [bar]			jemnosť filtra [µm]			
		M5	M7	G 3/8	G 1/4	G 3/8	G 1/2	G 3/4	G 1	QS4	QS6	0,5 ...	0,5 ...	2,5 ...	0,01	1	5	40
<b>jednotky úpravy vzduchu</b>																		
<b>FRC/FRCS</b> 	Micro	■	■	■	-	-	-	-	-	■	■	■	-	-	-	-	■	-
	Mini	-	-	■	■	■	-	-	-	-	■	■	-	-	-	-	■	■
	Midi	-	-	-	■	■	■	■	-	-	■	■	-	-	-	-	■	■
	Maxi	-	-	-	-	-	■	■	■	-	-	■	■	-	-	-	■	■
<b>kombinácie jednotiek úpravy vzduchu</b>																		
<b>FRC-K</b> 	Micro	-	-	-	-	-	-	-	-	-	-	-	-	-	-	-	-	
	Mini	-	-	■	■	-	-	-	-	-	-	■	■	-	-	-	-	■
	Midi	-	-	-	■	■	■	-	-	-	-	■	■	-	-	-	-	■
	Maxi	-	-	-	-	-	■	■	-	-	-	■	■	-	-	-	-	■
<b>LFR-K LFRS-K</b> 	Micro	-	-	-	-	-	-	-	-	-	-	-	-	-	-	-	-	
	Mini	-	-	■	■	-	-	-	-	-	-	■	■	-	-	-	-	■
	Midi	-	-	-	■	■	■	-	-	-	-	■	■	-	-	-	-	■
	Maxi	-	-	-	-	-	■	■	-	-	-	■	■	-	-	-	-	■
<b>jednotlivé zariadenia</b>																		
<b>filtre s redukčným ventilom LFR/LFRS</b> 	Micro	■	■	■	-	-	-	-	-	■	■	■	-	-	-	-	■	-
	Mini	-	-	■	■	■	-	-	-	-	■	■	-	-	-	-	■	■
	Midi	-	-	-	■	■	■	■	-	-	■	■	-	-	-	-	■	■
	Maxi	-	-	-	-	-	■	■	■	-	-	■	■	-	-	-	■	■
<b>filter LF</b> 	Micro	■	■	■	-	-	-	-	-	■	■	-	-	-	-	-	■	-
	Mini	-	-	■	■	■	-	-	-	-	-	-	-	-	-	-	■	■
	Midi	-	-	-	■	■	■	■	-	-	-	-	-	-	-	-	■	■
	Maxi	-	-	-	-	-	■	■	■	-	-	-	-	-	-	-	■	■
<b>jemný a veľmi jemný filter LFMA/LFMB</b> 	Micro	-	-	-	-	-	-	-	-	-	-	-	-	-	-	-	-	
	Mini	-	-	■	■	■	-	-	-	-	-	-	-	-	■	■	-	-
	Midi	-	-	-	■	■	■	■	-	-	-	-	-	-	■	■	-	-
	Maxi	-	-	-	-	-	■	■	■	-	-	-	-	-	■	■	-	-
<b>filter s aktívnym uhlím LFX</b> 	Micro	-	-	-	-	-	-	-	-	-	-	-	-	-	-	-	-	
	Mini	-	-	■	■	■	-	-	-	-	-	-	-	-	-	-	-	-
	Midi	-	-	-	■	■	■	■	-	-	-	-	-	-	-	-	-	-
	Maxi	-	-	-	-	-	■	■	■	-	-	-	-	-	-	-	-	-
<b>kombinácie filtrov LFMBA</b> 	Micro	-	-	-	-	-	-	-	-	-	-	-	-	-	-	-	-	
	Mini	-	-	■	■	■	-	-	-	-	-	-	-	-	■	■	-	-
	Midi	-	-	-	■	■	■	■	-	-	-	-	-	-	■	■	-	-
	Maxi	-	-	-	-	-	■	■	■	-	-	-	-	-	■	■	-	-
<b>tlakové regulačné ventily LR/LRS</b> 	Micro	■	■	■	-	-	-	-	-	■	■	■	-	-	-	-	-	
	Mini	-	-	■	■	■	-	-	-	-	-	■	■	-	-	-	-	-
	Midi	-	-	-	■	■	■	■	-	-	-	■	■	-	-	-	-	-
	Maxi	-	-	-	-	-	■	■	■	-	-	■	■	-	-	-	-	-

# Zaolejovače LOE, rad D, kovové

prehľad dodávok jednotiek úpravy vzduchu radu D, kov









typ	veľkosť	ochrana nádobiek		odlučovanie kondenzátu			indikácia tlaku		zabezpečenie ovládania		napájacie napätie			možnosti			→ strana/ internet
		kovový ochranný kôš	plastová nádobka	ručné, otáčaním	poloautomatické	plnoautomatické	s manometrom	bez manometra	otočný ovládač s aretáciou	otočný ovládač s integrovaným zámkom	24 V DC	110 V AC	230 V AC	priamo ovládaný tlakový regulačný ventil s integrovanou funkciou spätného prúdenia	nepriamo ovládaný tlakový regulačný ventil s integrovanou funkciou spätného prúdenia	indikácia tlakovej difference	
<b>jednotky úpravy vzduchu</b>																	
FRC/FRCS	Micro	-	■	■	■	-	■	■	■	-	-	-	-	-	-	-	frc
	Mini	■	-	■	-	■	■	■	■	■	-	-	-	-	-	-	
	Midi	■	-	■	-	■	■	■	■	■	-	-	-	-	-	-	
	Maxi	■	-	■	-	■	■	■	■	■	-	-	-	■	■	-	
<b>kombinácie jednotiek úpravy vzduchu</b>																	
FRC-K	Micro	-															frc
	Mini	■	-	■	-	■	■	-	■	-	■	-	-	-	-	-	
	Midi	■	-	■	-	■	■	-	■	-	■	-	-	-	-	-	
	Maxi	■	-	■	-	■	■	-	■	-	■	-	-	■	■	-	
LFR-K LFRS-K	Micro	-															lfr
	Mini	■	-	■	-	■	■	-	■	■	■	-	-	-	-	-	
	Midi	■	-	■	-	■	■	-	■	■	■	-	-	-	-	-	
	Maxi	■	-	■	-	■	■	-	■	■	■	-	-	■	■	-	
<b>jednotlivé zariadenia</b>																	
filtre s redukčným ventilom LFR/LFRS	Micro	-	■	■	■	-	■	■	■	-	-	-	-	-	-	-	lfr
	Mini	■	-	■	-	■	■	■	■	■	-	-	-	-	-	-	
	Midi	■	-	■	-	■	■	■	■	■	-	-	-	-	-	-	
	Maxi	■	-	■	-	■	■	■	■	■	-	-	-	■	■	-	
filter LF	Micro	-	■	■	■	-	-	-	-	-	-	-	-	-	-	-	lf
	Mini	■	-	■	-	■	-	-	-	-	-	-	-	-	-	-	
	Midi	■	-	■	-	■	-	-	-	-	-	-	-	-	-	-	
	Maxi	■	-	■	-	■	-	-	-	-	-	-	-	-	-	-	
jemný a veľmi jemný filter LFMA/LFMB	Micro	-															lfma, lfmb
	Mini	■	-	■	-	■	-	-	-	-	-	-	-	-	-	■	
	Midi	■	-	■	-	■	-	-	-	-	-	-	-	-	-	■	
	Maxi	■	-	■	-	■	-	-	-	-	-	-	-	-	-	■	
filter s aktívnym uhlím LFX	Micro	-															lfx
	Mini	■	-	-	-	-	-	-	-	-	-	-	-	-	-	-	
	Midi	■	-	-	-	-	-	-	-	-	-	-	-	-	-	-	
	Maxi	■	-	-	-	-	-	-	-	-	-	-	-	-	-	-	
kombinácie filtrov LFMBA	Micro	-															lfmba
	Mini	■	-	■	-	■	-	-	-	-	-	-	-	-	-	■	
	Midi	■	-	■	-	■	-	-	-	-	-	-	-	-	-	■	
	Maxi	■	-	■	-	■	-	-	-	-	-	-	-	-	-	■	
tlakové regulačné ventily LR/LRS	Micro	-	-	-	-	-	■	■	■	-	-	-	-	-	-	-	lr
	Mini	-	-	-	-	-	■	■	■	■	-	-	-	■	-	-	
	Midi	-	-	-	-	-	■	■	■	■	-	-	-	■	-	-	
	Maxi	-	-	-	-	-	■	■	■	■	-	-	-	■	■	-	

# Zaolejovače LOE, rad D, kovové

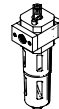
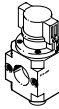
prehľad dodávok jednotiek úpravy vzduchu radu D, kov

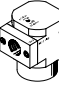
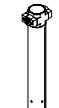
FESTO

typ	velkosť	pneumatické prípoj										rozsah regulovateľného tlaku [bar]		
		M5	M7	G1/8	G1/4	G3/8	G1/2	G3/4	G1	QS4	QS6	0,5 ... 7	0,5 ... 12	
<b>jednotlivé zariadenia</b>														
tlakové regulačné ventily <b>LRB/LRBS</b>		Micro	-											
		Mini	-	-	-	■	-	-	-	-	-	-	■	■
		Midi	-	-	-	-	■	-	-	-	-	-	■	■
		Maxi	-											
batérie tlakových regulačných ventilov <b>LRB-K</b>		Micro	-											
		Mini	-	-	-	■	■	-	-	-	-	-	■	■
		Midi	-	-	-	-	■	■	-	-	-	-	■	■
		Maxi	-											
zaolejovač <b>LOE</b>		Micro	■	■	■	-	-	-	-	-	■	■	-	-
		Mini	-	-	■	■	■	-	-	-	-	-	-	-
		Midi	-	-	-	■	■	■	■	-	-	-	-	-
		Maxi	-	-	-	-	-	■	■	■	-	-	-	-
zapínacie ventily <b>HE</b>		Micro	-											
		Mini	-	-	■	■	■	-	-	-	-	-	-	-
		Midi	-	-	-	■	■	■	■	-	-	-	-	-
		Maxi	-	-	-	-	-	■	■	■	-	-	-	-
zapínacie ventily <b>HEE</b>		Micro	-											
		Mini	-	-	■	■	■	-	-	-	-	-	-	-
		Midi	-	-	-	■	■	■	■	-	-	-	-	-
		Maxi	-	-	-	-	-	■	■	■	-	-	-	-
zapínacie ventily <b>HEP</b>		Micro	-											
		Mini	-	-	■	■	■	-	-	-	-	-	-	-
		Midi	-	-	-	■	■	■	■	-	-	-	-	-
		Maxi	-	-	-	-	-	■	■	■	-	-	-	-
pomalo nábehové ventily <b>HEL</b>		Micro	-											
		Mini	-	-	■	■	■	-	-	-	-	-	-	-
		Midi	-	-	-	■	■	■	■	-	-	-	-	-
		Maxi	-	-	-	-	-	■	■	■	-	-	-	-
membránový sušič vzduchu <b>LDM1</b>		Micro	-											
		Mini	-											
		Midi	-											
		Maxi	-	-	-	-	-	■	■	■	-	-	-	-
rozbočovacie moduly <b>FRM</b>		Micro	-											
		Mini	-	-	■	■	■	-	-	-	-	-	-	-
		Midi	-	-	-	■	■	■	■	-	-	-	-	-
		Maxi	-	-	-	-	-	■	■	■	-	-	-	-
rozdeľovací blok <b>FRZ</b>		Micro	-											
		Mini	-											
		Midi	-											
		Maxi	-											

# Zaolejovače LOE, rad D, kovové

prehľad dodávok jednotiek úpravy vzduchu radu D, kov



typ	veľkosť	ochrana nádobiek		indikácia tlaku		zabezpečenie ovládania		napájacie napätie			možnosti		→ strana/ internet
		kovový ochranný kôš	plastová nádobka	s manometrom	bez manometra	otočný ovládač s aretáciou	otočný ovládač s integrovaným zámkom	24 V DC	110 V AC	230 V AC	spätný ventil	tlakový spínač	
<b>jednotlivé zariadenia</b>													
tlakové regulačné ventily <b>LRB/LRBS</b>	Micro	-	-	-	■	■	■	-	-	-	-	-	lrb
	Mini	-	-	-	■	■	■	-	-	-	-	-	
	Midi	-	-	-	■	■	■	-	-	-	-	-	
	Maxi	-	-	-	■	■	■	-	-	-	-	-	
batérie tlakových regulačných ventilov	Micro	-	-	-	■	■	-	-	-	-	-	-	lrb
	Mini	-	-	-	■	■	-	-	-	-	-	-	
	Midi	-	-	-	■	■	-	-	-	-	-	-	
	Maxi	-	-	-	■	■	-	-	-	-	-	-	
zaolejovač <b>LOE</b>	Micro	-	■	-	■	-	-	-	-	-	-	-	6
	Mini	■	-	-	■	-	-	-	-	-	-	-	
	Midi	■	-	-	■	-	-	-	-	-	-	-	
	Maxi	■	-	-	■	-	-	-	-	-	-	-	
zapínacie ventily <b>HE</b>	Micro	-	-	-	■	■	-	-	-	-	-	-	he
	Mini	-	-	-	■	■	-	-	-	-	-	-	
	Midi	-	-	-	■	■	-	-	-	-	-	-	
	Maxi	-	-	-	■	■	-	-	-	-	-	-	
zapínacie ventily <b>HEE</b>	Micro	-	-	-	■	-	-	■	■	■	-	-	hee
	Mini	-	-	-	■	-	-	■	■	■	-	-	
	Midi	-	-	-	■	-	-	■	■	■	-	-	
	Maxi	-	-	-	■	-	-	■	■	■	-	-	
zapínacie ventily <b>HEP</b>	Micro	-	-	-	■	-	-	-	-	-	-	-	hep
	Mini	-	-	-	■	-	-	-	-	-	-	-	
	Midi	-	-	-	■	-	-	-	-	-	-	-	
	Maxi	-	-	-	■	-	-	-	-	-	-	-	
pomalo nábehové ventily <b>HEL</b>	Micro	-	-	-	■	-	-	-	-	-	-	-	hel
	Mini	-	-	-	■	-	-	-	-	-	-	-	
	Midi	-	-	-	■	-	-	-	-	-	-	-	
	Maxi	-	-	-	■	-	-	-	-	-	-	-	
membránový sušič vzduchu <b>LDM1</b>	Micro	-	-	-	-	-	-	-	-	-	-	-	ldm1
	Mini	-	-	-	-	-	-	-	-	-	-	-	
	Midi	-	-	-	-	-	-	-	-	-	-	-	
	Maxi	■	-	-	■	-	-	-	-	-	-	-	
rozbočovacie moduly <b>FRM</b>	Micro	-	-	-	■	-	-	-	-	-	■	■	frm
	Mini	-	-	-	■	-	-	-	-	-	■	■	
	Midi	-	-	-	■	-	-	-	-	-	■	■	
	Maxi	-	-	-	■	-	-	-	-	-	■	■	
rozdeľovací blok <b>FRZ</b>	Micro	-	-	-	■	-	-	-	-	-	-	-	frz
	Mini	-	-	-	■	-	-	-	-	-	-	-	
	Midi	-	-	-	■	-	-	-	-	-	-	-	
	Maxi	-	-	-	■	-	-	-	-	-	-	-	

# Zaolejovače LOE, rad D, kovové

prehľad príslušenstva

FESTO

## Micro

samostatné zariadenie s pripojovacími doskami, pripojovací rozmer G $\frac{1}{8}$ , QS4 alebo QS6

samostatné zariadenie bez pripojovacích dosiek, pre kombináciu jednotiek úpravy vzduchu, pripojovací rozmer M5 alebo M7 v telese

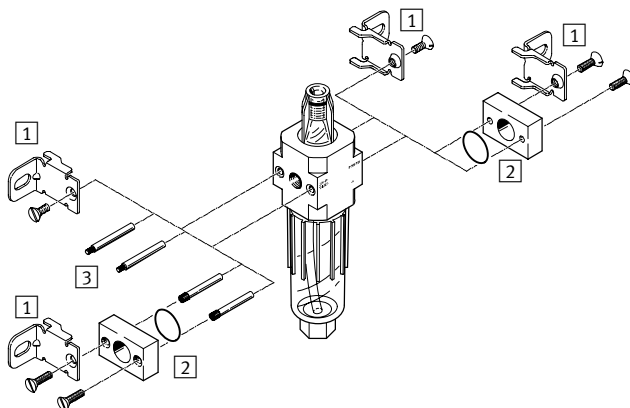
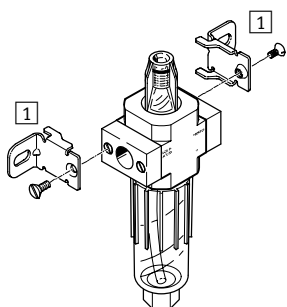

### Upevňovacie prvky a príslušenstvo

	samostatné zariadenie		kombinácia		→ strana/internet
	s pripojovacími doskami	bez pripojovacích dosiek	s pripojovacími doskami	bez pripojovacích dosiek	
1 upevňovací uholník HFOE	■	■	■	■	hfoe-d
2 pripojovacia sada PBL	-	■	-	■	pbl
3 čap so závitom FRB	-	-	■	■	frb-d

## Mini/Midi/Maxi

samostatné zariadenie s pripojovacími doskami

samostatné zariadenie bez pripojovacích dosiek, pre kombináciu jednotiek úpravy vzduchu

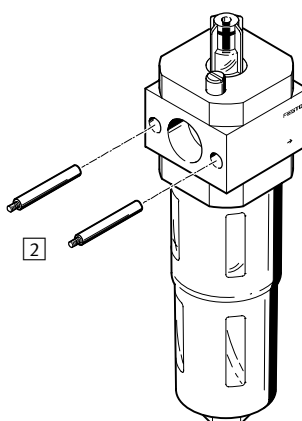
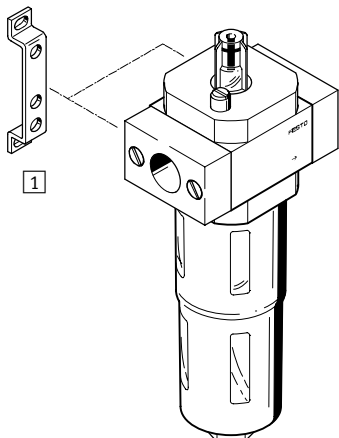

### Upevňovacie prvky a príslušenstvo

	samostatné zariadenie		kombinácia		→ strana/internet
	s pripojovacími doskami	bez pripojovacích dosiek	s pripojovacími doskami	bez pripojovacích dosiek	
1 upevňovací uholník HFOE	■	-	■	-	hfoe-d
2 čap so závitom (obsiahnutý v dodávke) FRB	-	-	■	■	frb-d

# Zaolejovače LOE, rad D, kovové

legenda k typovému označeniu

FESTO

LOE		-	1/4	-	D	-	MIDI
<b>základná funkcia</b>							
LOE	zaolejovače						
<b>pneumatický prípoj</b>							
MINI/MIDI/MAXI							
	bez pripojovacích dosiek						
MICRO							
M5	vnútorný závit M5						
M7	vnútorný závit M7						
1/8	pripojovacie dosky so závitom G1/8						
QS4	pripojovacie dosky s nástrčným prípojom QS-4						
QS6	pripojovacie dosky s nástrčným prípojom QS-6						
MINI							
1/8	pripojovacie dosky so závitom G1/8						
1/4	pripojovacie dosky so závitom G1/4						
3/8	pripojovacie dosky so závitom G3/8						
MIDI							
1/4	pripojovacie dosky so závitom G1/4						
3/8	pripojovacie dosky so závitom G3/8						
1/2	pripojovacie dosky so závitom G1/2						
3/4	pripojovacie dosky so závitom G3/4						
MAXI							
1/2	pripojovacie dosky so závitom G1/2						
3/4	pripojovacie dosky so závitom G3/4						
1	pripojovacie dosky so závitom G1						
<b>rad</b>							
D	rad						
<b>veľkosť</b>							
MICRO	rozmer rastra 25 mm (bez pripojovacích dosiek)						
MINI	rozmer rastra 40 mm (bez pripojovacích dosiek)						
MIDI	rozmer rastra 55 mm (bez pripojovacích dosiek)						
MAXI	rozmer rastra 66 mm (bez pripojovacích dosiek)						

# Zaolejovače LOE, rad D, kovové

údajový list

FESTO

funkcia

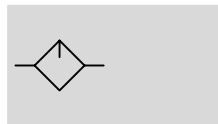

- - **prietok**  
160 ... 9 000 l/min
- - **teplotný rozsah**  
-10 ... +60 °C
- - **prevádzkový tlak**  
0 ... 16 bar



Proporcionálny zaolejovač privádza do stlačeného vzduchu presne nastavené množstvo oleja. Pokles tlaku, ku ktorému dochádza pri prietoku cez Venturiho dýzu, sa využíva k preprave oleja zo zásobníka až ku krytu pre odkvapkávanie.

Odtiaľ je kvapka oleja odvádzaná do vzduchového kanálika, tesne za proporcionálnym ventilom, kde je rozprášená. Podiel olejovej hmly je úmerný množstvu pretekajúceho vzduchu.

- proporcionálny zaolejovač s presným dávkovaním oleja
- zabráňuje opotrebovaniu veľmi namáhaných pohonov
- vysoká priepustnosť
- jednoduché a rýchle doplnenie oleja
- robustné kovové teleso
- priehľadná nádobka na olej s kovovým ochranným košom

Pre zariadenia Festo odporúčame nasledujúce oleje: rozsah viskozity podľa ISO 3448, ISO trieda VG 32 32 mm<sup>2</sup>/s (= cSt) pri 40 °C

- Špeciálny olej Festo → 14
- ARAL Vitam GF 32
- BP Energol HLP 32
- Esso Nuto H 32
- Mobil DTE 24
- Shell Tellus Oil DO 32

Všeobecné technické údaje																		
veľkosť	Micro				Mini				Midi				Maxi					
pneumatický prípoj 1, 2	M5 <sup>1)</sup>	M7 <sup>1)</sup>	G1/8	QS4	QS6	G1/8	G1/4	G3/8	- <sup>2)</sup>	G1/4	G3/8	G1/2	G3/4	- <sup>2)</sup>	G1/2	G3/4	G1	- <sup>2)</sup>
konštrukcia	proporcionálny štandardný zaolejovač vytvárajúci olejovú hmlu																	
spôsob upevnenia	s príslušenstvom																	
	zapojenie do vedenia																	
montážna poloha	zvislá ±5°																	
trieda čistoty výstupného vzduchu	stlačený vzduch podľa ISO 8573-1:2010 [7:4:4]																	
	inertné plyny																	
ochrana nádobiek	-				kovový ochranný kôš													
minimálny prietok pre funkciu zaolejovača [l/min]	3				3				8				10					
max. množstvo oleja [cm <sup>3</sup> ]	6,5				45				110				190					

1) vnútorný závit

2) bez pripojovacích dosiek

- | - Upozornenie: Tento výrobok zodpovedá ISO 1179-1 a ISO 228-1.

Nominálny prietok <sup>1)</sup> q <sub>nN</sub> [l/min]					
veľkosť	Micro				
pneumatický prípoj 1, 2	M5	M7	G1/8	QS-4	QS-6
LOE	200	430	410	160	330

1) merané pri p<sub>1</sub> = 6 bar a Δp = 1 bar

Nominálny prietok q <sub>nN</sub> <sup>1)</sup> [l/min]										
veľkosť	Mini			Midi				Maxi		
pneumatický prípoj 1, 2	G1/8	G1/4	G3/8	G1/4	G3/8	G1/2	G3/4	G1/2	G3/4	G1
LOE	1300	2300	2700	2800	5500	6100	6300	8300	8400	9000

1) merané pri p<sub>1</sub> = 6 bar a Δp = 1 bar



# Zaolejovače LOE, rad D, kovové

údajový list

FESTO

Prevádzkové podmienky a podmienky okolia				
veľkosť	Micro	Mini	Midi	Maxi
prevádzkový tlak [bar]	1 ... 10	0 ... 16		
prevádzkové médium	stlačený vzduch podľa ISO 8573-1:2010 [7:4:4] inertné plyny			
upozornenie pre prevádzkové/ riadiace médium	prevádzka s mazaním možná (potrebné pri ďalšej prevádzke)			
teplota okolia [°C]	-10 ... +60			
teplota média [°C]	-10 ... +60			
skladovacia teplota [°C]	-10 ... +60			
odolnosť proti korózii KBK <sup>1)</sup>	2			
osvedčenie	spoločnosť Germanischer Lloyd			

1) Trieda odolnosti proti korózii 2 podľa normy Festo 940 070:

Konštrukčne diely s miernymi narokmi na odolnosť proti korózii. Vonkajšie viditeľne časti s požiadavkami predovšetkým na vzhľad povrchu, ktorý je vystavený priamemu kontaktu s okolitou pre priemysel bežnou atmosférou prípadne kontaktu s médiami, ako su chladiace látky a maziva.

Hmotnosti [g]						
veľkosť	Micro		Mini	Midi	Maxi	
	vnútorný závit	pripojovacia doska			pripojenie G1½, G¾	pripojenie G1
LOE	39	59	270	630	1100	1200

## Materiály

funkčný rez

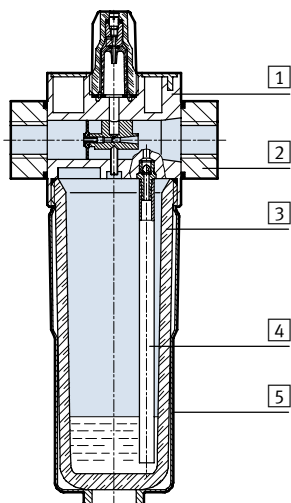

veľkosť	Micro	Mini/Midi/Maxi
1 teleso	hliníkový tlakový odliatok	zinková tlaková liatina/hliník
2 pripojovacie dosky	hliníková tvárna zliatina	zinková tlaková liatina/hliník
3 nádoba	PC	
4 trubka	PE	
5 kovový ochranný kôš	-	hliníková tvárna zliatina
- tesnenia	NBR	
poznámka o materiáli	v zmysle RoHS	

# Zaolejovače LOE, rad D, kovové

údajový list



## Normálny prietok $q_n$ v závislosti od tlakovej diferencie $\Delta p_{1-2}$

LOE-M5-D-MICRO

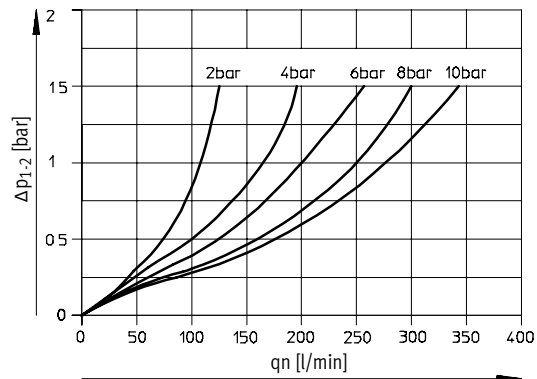

LOE-M7-D-MICRO B

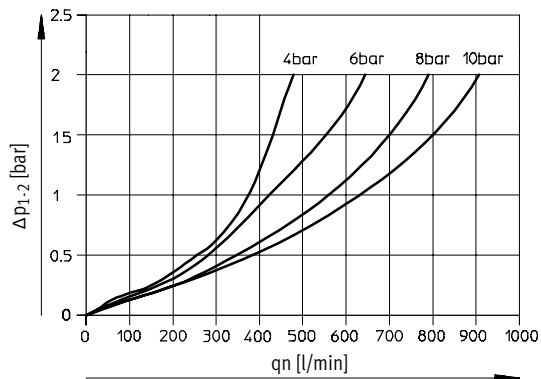

LOE-1/8-D-MICRO

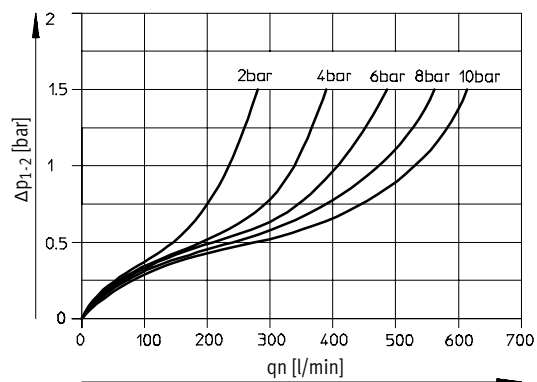

LOE-QS4-D-MICRO

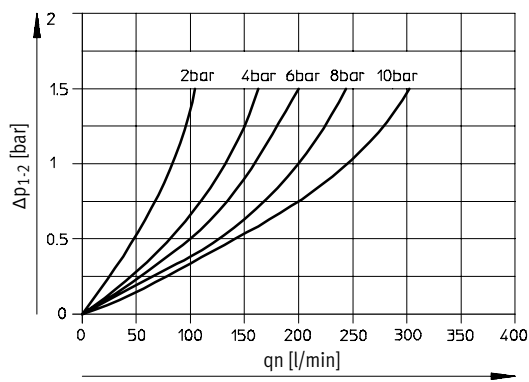

LOE-QS6-D-MICRO

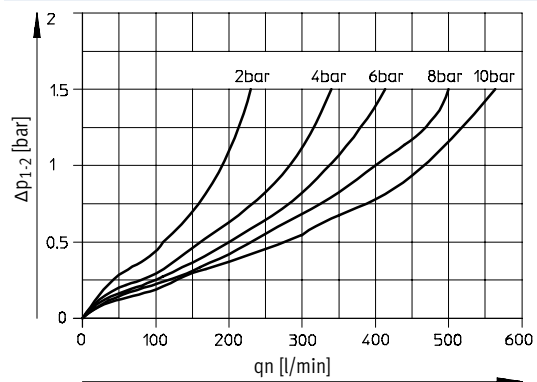

# Zaolejšovače LOE, rad D, kovové

údajový list

## Normálny prietok $q_n$ v závislosti od tlakovej diferencie $\Delta p_{1-2}$

LOE-1/4-D-MINI

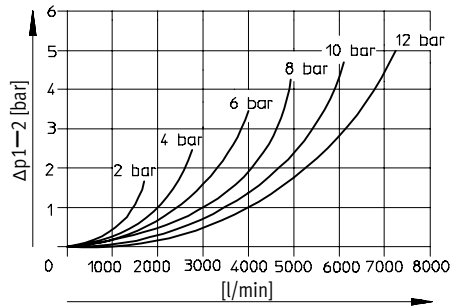

LOE-1/2-D-MIDI

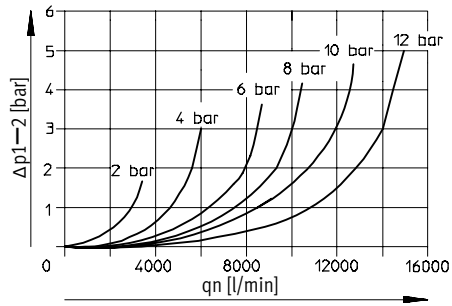

LOE-1-D-MAXI

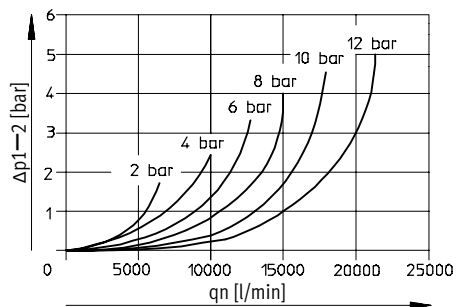

## Rozmery – micro

sťahovanie CAD modelov → [www.festo.sk](http://www.festo.sk)

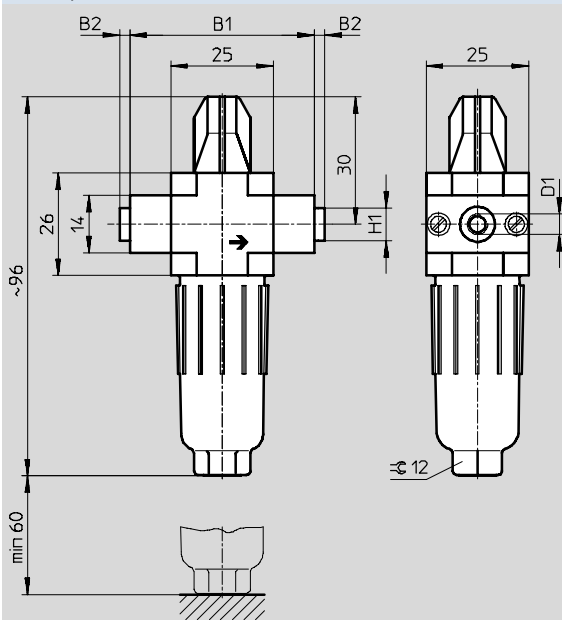

→ smer prietoku

typ	B1	B2	D1	H1
LOE-M5-D-MICRO	25	-	M5	-
LOE-M7-D-MICRO B			M7	
LOE-1/8-D-MICRO			G1/8	
LOE-QS4-D-MICRO	45	~2,5	QS-4	~8
LOE-QS6-D-MICRO			QS-6	~10

UPOZORNENIE: Tento výrobok zodpovedá ISO 1179-1 a ISO 228-1.

# Zaolejovače LOE, rad D, kovové

údajový list

FESTO

## Rozmery – Mini/Midi/Maxi

sťahovanie CAD modelov → [www.festo.sk](http://www.festo.sk)

pripojovacie dosky so závitmi

bez pripojovacích dosiek

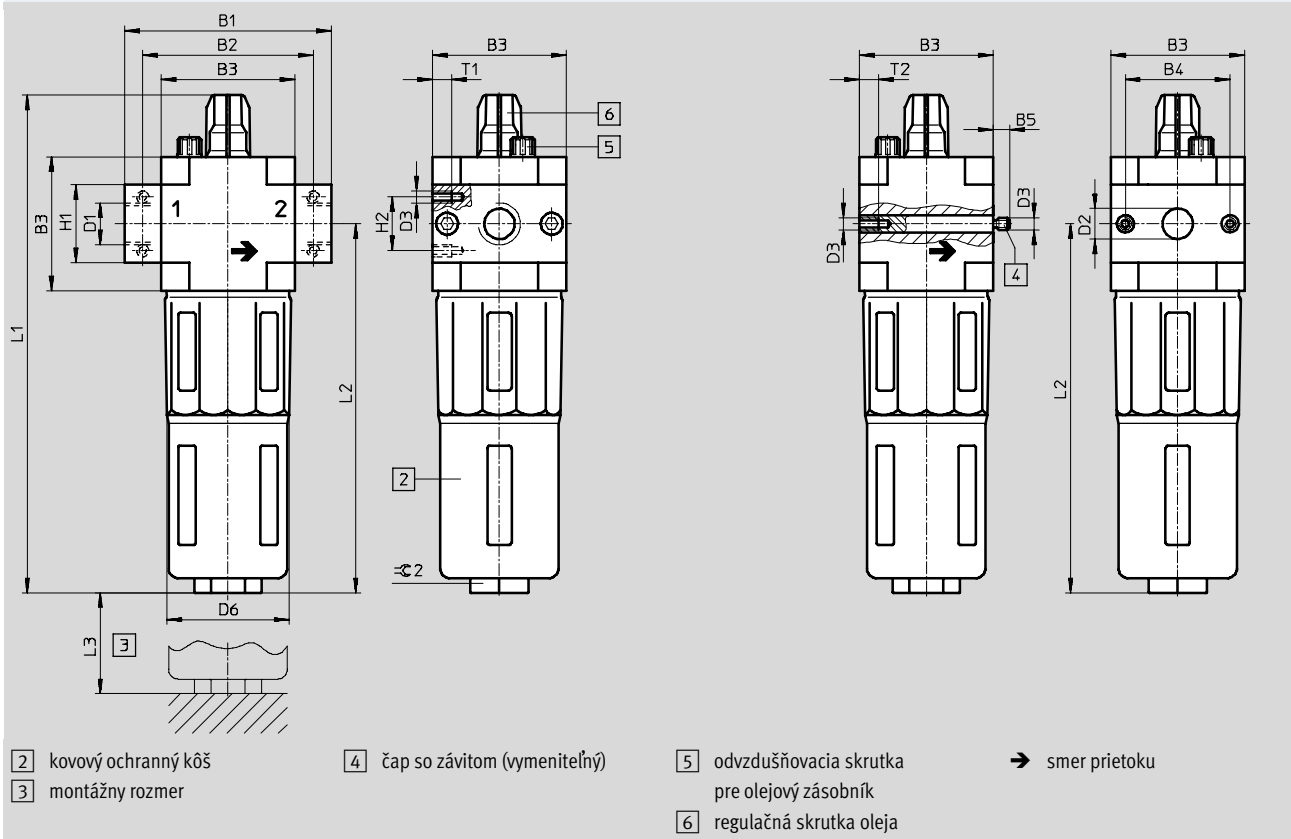

typ	B1	B2	B3	B4	B5	D1	D2 Ø	D3	D6 Ø	H1	H2	L1	L2	L3	T1	T2	⊖ 2
<b>Mini</b>																	
LOE-1/8-D-MINI	64	52	40	30	-	G1/8	-	M4	38	20	11	169	124	100	7	-	22
LOE-1/4-D-MINI						G1/4											
LOE-3/8-D-MINI	70					G3/8											
LOE-D-MINI	-	-			5,8	-	11									10	
<b>Midi</b>																	
LOE-1/4-D-MIDI	85	70	55	43	-	G1/4	-	M5	52	32	22	204	151	120	8	-	24
LOE-3/8-D-MIDI						G3/8											
LOE-1/2-D-MIDI						G1/2											
LOE-3/4-D-MIDI						G3/4											
LOE-D-MIDI	-	-			6,8	-	24									11	
<b>Maxi</b>																	
LOE-1/2-D-MAXI	96	80	66	46	-	G1/2	-	M5	65	32	22	228	170	150	8	-	24
LOE-3/4-D-MAXI						G3/4											
LOE-1-D-MAXI	116	91				G1				40							
LOE-D-MAXI	-	-			6,8	-	30									11	

UPOZORNENIE: Tento výrobok zodpovedá ISO 1179-1 a ISO 228-1.

# Zaolejovače LOE, rad D, kovové

údajový list

**FESTO**

Typové označenie – Micro			
veľkosť	prípoj	č. dielu	typ
vnútorný závit			
Micro	M5	526309	LOE-M5-D-MICRO
	M7	534188	LOE-M7-D-MICRO-B
prípojovacie dosky so závitmi			
Micro	G $\frac{1}{8}$	526310	LOE- $\frac{1}{8}$ -D-MICRO
prípojovacie dosky s nástrčným prípojom			
Micro	QS-4	526313	LOE-QS4-D-MICRO
	QS-6	526314	LOE-QS6-D-MICRO

Typové označenie – Mini/Midi/Maxi			
veľkosť	prípoj	č. dielu	typ
bez prípojovacích dosiek			
Mini	–	192575	LOE-D-MINI
Midi	–	192576	LOE-D-MIDI
Maxi	–	192577	LOE-D-MAXI
prípojovacie dosky so závitmi			
Mini	G $\frac{1}{8}$	159620	LOE- $\frac{1}{8}$ -D-MINI
	G $\frac{1}{4}$	159621	LOE- $\frac{1}{4}$ -D-MINI
	G $\frac{3}{8}$	162680	LOE- $\frac{3}{8}$ -D-MINI
Midi	G $\frac{1}{4}$	186479	LOE- $\frac{1}{4}$ -D-MIDI
	G $\frac{3}{8}$	159586	LOE- $\frac{3}{8}$ -D-MIDI
	G $\frac{1}{2}$	159587	LOE- $\frac{1}{2}$ -D-MIDI
	G $\frac{3}{4}$	162681	LOE- $\frac{3}{4}$ -D-MIDI
Maxi	G $\frac{1}{2}$	186480	LOE- $\frac{1}{2}$ -D-MAXI
	G $\frac{3}{4}$	159622	LOE- $\frac{3}{4}$ -D-MAXI
	G1	159623	LOE-1-D-MAXI

## Zaolejovače LOE, konštrukčný rad D

príslušenstvo

**FESTO**

Špeciálny olej



Typové označenie		
rozsah dodávky	č. dielu	typ
1 liter	152811	OFSW-32