

## Membránové sušiče vzduchu LDM1, konstrukční rad D

**FESTO**



# Membránový sušič vzduchu LDM1, rad D, kov

prehľad dodávok jednotiek úpravy vzduchu radu D, kov

FESTO

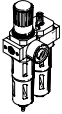
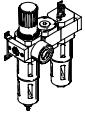
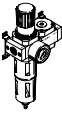
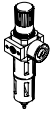
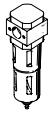
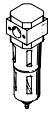
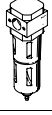
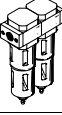
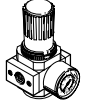
typ	velkosť	pneumatický prípoj										rozsah regulačného tlaku [bar]			jemnosť filtra [µm]			
		M5	M7	G $\frac{3}{8}$	G $\frac{1}{4}$	G $\frac{3}{8}$	G $\frac{1}{2}$	G $\frac{3}{4}$	G1	QS4	QS6	0,5 ...	0,5 ...	2,5 ...	0,01	1	5	40
<b>jednotky úpravy vzduchu</b>																		
<b>FRC/FRCS</b> 	Micro	■	■	■	-	-	-	-	-	■	■	■	-	-	-	-	■	-
	Mini	-	-	■	■	■	-	-	-	-	■	■	-	-	-	-	■	■
	Midi	-	-	-	■	■	■	■	-	-	■	■	-	-	-	-	■	■
	Maxi	-	-	-	-	-	■	■	■	-	-	■	■	-	-	-	■	■
<b>kombinácie jednotiek úpravy vzduchu</b>																		
<b>FRC-K</b> 	Micro	-	-	-	-	-	-	-	-	-	-	-	-	-	-	-	-	
	Mini	-	-	■	■	-	-	-	-	-	-	■	■	-	-	-	-	■
	Midi	-	-	-	■	■	■	-	-	-	-	■	■	-	-	-	-	■
	Maxi	-	-	-	-	-	■	■	-	-	-	■	■	-	-	-	-	■
<b>LFR-K LFRS-K</b> 	Micro	-	-	-	-	-	-	-	-	-	-	-	-	-	-	-	-	
	Mini	-	-	■	■	-	-	-	-	-	-	■	■	-	-	-	-	■
	Midi	-	-	-	■	■	■	-	-	-	-	■	■	-	-	-	-	■
	Maxi	-	-	-	-	-	■	■	-	-	-	■	■	-	-	-	-	■
<b>jednotlivé zariadenia</b>																		
<b>filtre s redukčným ventilom LFR/LFRS</b> 	Micro	■	■	■	-	-	-	-	-	■	■	■	-	-	-	-	■	-
	Mini	-	-	■	■	■	-	-	-	-	■	■	-	-	-	-	■	■
	Midi	-	-	-	■	■	■	■	-	-	■	■	-	-	-	-	■	■
	Maxi	-	-	-	-	-	■	■	■	-	-	■	■	-	-	-	■	■
<b>filter LF</b> 	Micro	■	■	■	-	-	-	-	-	■	■	-	-	-	-	-	■	-
	Mini	-	-	■	■	■	-	-	-	-	-	-	-	-	-	-	■	■
	Midi	-	-	-	■	■	■	■	-	-	-	-	-	-	-	-	■	■
	Maxi	-	-	-	-	-	■	■	■	-	-	-	-	-	-	-	■	■
<b>jemný a veľmi jemný filter LFMA/LFMB</b> 	Micro	-	-	-	-	-	-	-	-	-	-	-	-	-	-	-	-	
	Mini	-	-	■	■	■	-	-	-	-	-	-	-	■	■	-	-	-
	Midi	-	-	-	■	■	■	■	-	-	-	-	-	■	■	-	-	-
	Maxi	-	-	-	-	-	■	■	■	-	-	-	-	■	■	-	-	-
<b>filter s aktívnym uhlím LFX</b> 	Micro	-	-	-	-	-	-	-	-	-	-	-	-	-	-	-	-	
	Mini	-	-	■	■	■	-	-	-	-	-	-	-	-	-	-	-	-
	Midi	-	-	-	■	■	■	■	-	-	-	-	-	-	-	-	-	-
	Maxi	-	-	-	-	-	■	■	■	-	-	-	-	-	-	-	-	-
<b>kombinácie filtrov LFMBA</b> 	Micro	-	-	-	-	-	-	-	-	-	-	-	-	-	-	-	-	
	Mini	-	-	■	■	■	-	-	-	-	-	-	-	■	■	-	-	-
	Midi	-	-	-	■	■	■	■	-	-	-	-	-	■	■	-	-	-
	Maxi	-	-	-	-	-	■	■	■	-	-	-	-	■	■	-	-	-
<b>tlakové regulačné ventily LR/LRS</b> 	Micro	■	■	■	-	-	-	-	-	■	■	■	-	-	-	-	-	-
	Mini	-	-	■	■	■	-	-	-	-	-	■	■	-	-	-	-	-
	Midi	-	-	-	■	■	■	■	-	-	-	■	■	-	-	-	-	-
	Maxi	-	-	-	-	-	■	■	■	-	-	■	■	-	-	-	-	-

# Membránový sušič vzduchu LDM1, rad D, kov

prehľad dodávok jednotiek úpravy vzduchu radu D, kov









typ	veľkosť	ochrana nádobiek		odlučovanie kondenzátu			indikácia tlaku		zabezpečenie ovládania		napájacie napätie			možnosti			→ strana/ internet
		kovový ochranný kôš	plastová nádobka	ručné, otáčaním	poloautomatické	plnoautomatické	s manometrom	bez manometra	otočný ovládač s aretáciou	otočný ovládač s integrovaným zámkom	24 V DC	110 V AC	230 V AC	priamo ovládaný tlakový regulačný ventil s integrovanou funkciou spätného prúdenia	nepriamo ovládaný tlakový regulačný ventil s integrovanou funkciou spätného prúdenia	indikácia tlakovej difference	
<b>jednotky úpravy vzduchu</b>																	
FRC/FRCS	Micro	-	■	■	■	-	■	■	■	-	-	-	-	-	-	-	frc
	Mini	■	-	■	-	■	■	■	■	■	-	-	-	-	-	-	
	Midi	■	-	■	-	■	■	■	■	■	-	-	-	-	-	-	
	Maxi	■	-	■	-	■	■	■	■	■	-	-	-	■	■	-	
<b>kombinácie jednotiek úpravy vzduchu</b>																	
FRC-K	Micro	-															frc
	Mini	■	-	■	-	■	■	-	■	-	-	-	-	-	-	-	
	Midi	■	-	■	-	■	■	-	■	-	-	-	-	-	-	-	
	Maxi	■	-	■	-	■	■	-	■	-	-	-	-	■	■	-	
LFR-K LFRS-K	Micro	-															lfr
	Mini	■	-	■	-	■	■	-	■	■	■	-	-	-	-	-	
	Midi	■	-	■	-	■	■	-	■	■	■	-	-	-	-	-	
	Maxi	■	-	■	-	■	■	-	■	■	■	-	-	■	■	-	
<b>jednotlivé zariadenia</b>																	
filtre s redukčným ventilom LFR/LFRS	Micro	-	■	■	■	-	■	■	■	-	-	-	-	-	-	-	lfr
	Mini	■	-	■	-	■	■	■	■	■	-	-	-	-	-	-	
	Midi	■	-	■	-	■	■	■	■	■	-	-	-	-	-	-	
	Maxi	■	-	■	-	■	■	■	■	■	-	-	-	■	■	-	
filter LF	Micro	-	■	■	■	-	-	-	-	-	-	-	-	-	-	-	lf
	Mini	■	-	■	-	■	-	-	-	-	-	-	-	-	-	-	
	Midi	■	-	■	-	■	-	-	-	-	-	-	-	-	-	-	
	Maxi	■	-	■	-	■	-	-	-	-	-	-	-	-	-	-	
jemný a veľmi jemný filter LFMA/LFMB	Micro	-															lfma, lfmb
	Mini	■	-	■	-	■	-	-	-	-	-	-	-	-	-	■	
	Midi	■	-	■	-	■	-	-	-	-	-	-	-	-	-	■	
	Maxi	■	-	■	-	■	-	-	-	-	-	-	-	-	-	■	
filter s aktívnym uhlím LFX	Micro	-															lfx
	Mini	■	-	-	-	-	-	-	-	-	-	-	-	-	-	-	
	Midi	■	-	-	-	-	-	-	-	-	-	-	-	-	-	-	
	Maxi	■	-	-	-	-	-	-	-	-	-	-	-	-	-	-	
kombinácie filtrov LFMBA	Micro	-															lfmba
	Mini	■	-	■	-	■	-	-	-	-	-	-	-	-	-	■	
	Midi	■	-	■	-	■	-	-	-	-	-	-	-	-	-	■	
	Maxi	■	-	■	-	■	-	-	-	-	-	-	-	-	-	■	
tlakové regulačné ventily LR/LRS	Micro	-	-	-	-	-	■	■	■	-	-	-	-	-	-	-	lr
	Mini	-	-	-	-	-	■	■	■	■	-	-	-	■	-	-	
	Midi	-	-	-	-	-	■	■	■	■	-	-	-	■	-	-	
	Maxi	-	-	-	-	-	■	■	■	■	-	-	-	■	■	-	

# Membránový sušič vzduchu LDM1, rad D, kov

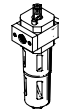
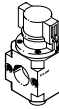
prehľad dodávok jednotiek úpravy vzduchu radu D, kov

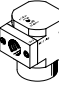
FESTO

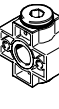
typ	velkosť	pneumatické prípoj										rozsah regulovaneho tlaku [bar]		
		M5	M7	G1/8	G1/4	G3/8	G1/2	G3/4	G1	QS4	QS6	0,5 ... 7	0,5 ... 12	
<b>jednotlivé zariadenia</b>														
tlakové regulačné ventily <b>LRB/LRBS</b>		Micro	-											
		Mini	-	-	-	■	-	-	-	-	-	-	■	■
		Midi	-	-	-	-	■	-	-	-	-	-	■	■
		Maxi	-											
batérie tlakových regulačných ventilov <b>LRB-K</b>		Micro	-											
		Mini	-	-	-	■	■	-	-	-	-	-	■	■
		Midi	-	-	-	-	■	■	-	-	-	-	■	■
		Maxi	-											
zaolejovač <b>LOE</b>		Micro	■	■	■	-	-	-	-	-	■	■	-	-
		Mini	-	-	■	■	■	-	-	-	-	-	-	-
		Midi	-	-	-	■	■	■	■	-	-	-	-	-
		Maxi	-	-	-	-	-	■	■	■	-	-	-	-
zapínacie ventily <b>HE</b>		Micro	-											
		Mini	-	-	■	■	■	-	-	-	-	-	-	-
		Midi	-	-	-	■	■	■	■	-	-	-	-	-
		Maxi	-	-	-	-	-	■	■	■	-	-	-	-
zapínacie ventily <b>HEE</b>		Micro	-											
		Mini	-	-	■	■	■	-	-	-	-	-	-	-
		Midi	-	-	-	■	■	■	■	-	-	-	-	-
		Maxi	-	-	-	-	-	■	■	■	-	-	-	-
zapínacie ventily <b>HEP</b>		Micro	-											
		Mini	-	-	■	■	■	-	-	-	-	-	-	-
		Midi	-	-	-	■	■	■	■	-	-	-	-	-
		Maxi	-	-	-	-	-	■	■	■	-	-	-	-
pomalo nábehové ventily <b>HEL</b>		Micro	-											
		Mini	-	-	■	■	■	-	-	-	-	-	-	-
		Midi	-	-	-	■	■	■	■	-	-	-	-	-
		Maxi	-	-	-	-	-	■	■	■	-	-	-	-
membránový sušič vzduchu <b>LDM1</b>		Micro	-											
		Mini	-											
		Midi	-											
		Maxi	-	-	-	-	-	■	■	■	-	-	-	-
rozbočovacie moduly <b>FRM</b>		Micro	-											
		Mini	-	-	■	■	■	-	-	-	-	-	-	-
		Midi	-	-	-	■	■	■	■	-	-	-	-	-
		Maxi	-	-	-	-	-	■	■	■	-	-	-	-
rozdeľovací blok <b>FRZ</b>		Micro	-											
		Mini	-											
		Midi	-											
		Maxi	-											

# Membránový sušič vzduchu LDM1, rad D, kov

prehľad dodávok jednotiek úpravy vzduchu radu D, kov



typ	veľkosť	ochrana nádobiek		indikácia tlaku		zabezpečenie ovládania		napájacie napätie			možnosti		→ strana/ internet
		kovový ochranný kôš	plastová nádobka	s manometrom	bez manometra	otočný ovládač s aretáciou	otočný ovládač s integrovaným zámkom	24 V DC	110 V AC	230 V AC	spätný ventil	tlakový spínač	
<b>jednotlivé zariadenia</b>													
tlakové regulačné ventily <b>LRB/LRBS</b>	Micro	-	-	-	■	■	■	-	-	-	-	-	lrb
	Mini	-	-	-	■	■	■	-	-	-	-	-	
	Midi	-	-	-	■	■	■	-	-	-	-	-	
	Maxi	-	-	-	■	■	■	-	-	-	-	-	
batérie tlakových regulačných ventilov	Micro	-	-	-	■	■	-	-	-	-	-	-	lrb
	Mini	-	-	-	■	■	-	-	-	-	-	-	
	Midi	-	-	-	■	■	-	-	-	-	-	-	
	Maxi	-	-	-	■	■	-	-	-	-	-	-	
zaolejovač <b>LOE</b>	Micro	-	■	-	■	-	-	-	-	-	-	-	loe
	Mini	■	-	-	■	-	-	-	-	-	-	-	
	Midi	■	-	-	■	-	-	-	-	-	-	-	
	Maxi	■	-	-	■	-	-	-	-	-	-	-	
zapínacie ventily <b>HE</b>	Micro	-	-	-	■	■	-	-	-	-	-	-	hee
	Mini	-	-	-	■	■	-	-	-	-	-	-	
	Midi	-	-	-	■	■	-	-	-	-	-	-	
	Maxi	-	-	-	■	■	-	-	-	-	-	-	
zapínacie ventily <b>HEE</b>	Micro	-	-	-	■	-	-	■	■	■	-	-	hee
	Mini	-	-	-	■	-	-	■	■	■	-	-	
	Midi	-	-	-	■	-	-	■	■	■	-	-	
	Maxi	-	-	-	■	-	-	■	■	■	-	-	
zapínacie ventily <b>HEP</b>	Micro	-	-	-	■	-	-	-	-	-	-	-	hep
	Mini	-	-	-	■	-	-	-	-	-	-	-	
	Midi	-	-	-	■	-	-	-	-	-	-	-	
	Maxi	-	-	-	■	-	-	-	-	-	-	-	
pomalo nábehové ventily <b>HEL</b>	Micro	-	-	-	■	-	-	-	-	-	-	-	hel
	Mini	-	-	-	■	-	-	-	-	-	-	-	
	Midi	-	-	-	■	-	-	-	-	-	-	-	
	Maxi	-	-	-	■	-	-	-	-	-	-	-	
membránový sušič vzduchu <b>LDM1</b>	Micro	-	-	-	-	-	-	-	-	-	-	-	6
	Mini	-	-	-	-	-	-	-	-	-	-	-	
	Midi	-	-	-	-	-	-	-	-	-	-	-	
	Maxi	■	-	-	■	-	-	-	-	-	-	-	
rozbočovacie moduly <b>FRM</b>	Micro	-	-	-	■	-	-	-	-	-	■	■	frm
	Mini	-	-	-	■	-	-	-	-	-	■	■	
	Midi	-	-	-	■	-	-	-	-	-	■	■	
	Maxi	-	-	-	■	-	-	-	-	-	■	■	
rozdeľovací blok <b>FRZ</b>	Micro	-	-	-	■	-	-	-	-	-	-	-	frz
	Mini	-	-	-	■	-	-	-	-	-	-	-	
	Midi	-	-	-	■	-	-	-	-	-	-	-	
	Maxi	-	-	-	■	-	-	-	-	-	-	-	

# Membránový sušič vzduchu LDM1, rad D, kov

prehľad príslušenstva a legenda k typovému označeniu

FESTO

## Maxi

samostatné zariadenie s pripojovacími doskami

samostatné zariadenie bez pripojovacích dosiek,  
pre kombináciu jednotiek úpravy vzduchu

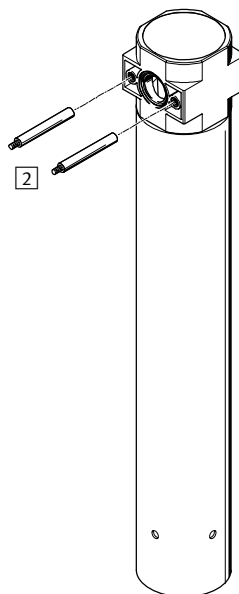
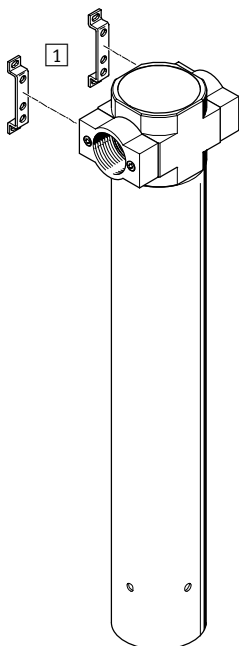

Upevňovacie prvky a príslušenstvo					
	samostatné zariadenie		kombinácia		→ strana/ internet
	s pripojovacími doskami	bez pripojovacích dosiek	s pripojovacími doskami	bez pripojovacích dosiek	
1 upevňovací uholník HFOE	■	-	■	-	hfoe-d
2 čap so závitom (obsiahnutý v dodávke) FRB	-	-	■	■	frb-d

LDM1 - 1/2 - D - MAXI - 300

### základná funkcia

LDM1 membránový sušič vzduchu

### pneumatický prípoj

-	bez pripojovacích dosiek
1/2	závit G1/2
3/4	závit G3/4
1	závit G1

### rad

D rad

### veľkosť

MAXI rozmer rastra 66 mm  
(bez pripojovacích dosiek)

### nominálny prietok výstup $q_n$ výst

300	300 l/ min
600	600 l/ min
1000	1 000 l/min

# Membránový sušič vzduchu LDM1, rad D, kov

údajový list

FESTO

funkcia

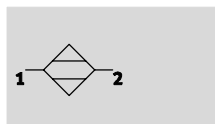

- - **prietok**  
300 ... 1000 l/min

- - **teplotný rozsah**  
+2 ... +50 °C

- - **vstupný tlak**  
3 ... 12,5 bar

zniženie rosného bodu:  
LDM1-...-300/600: 20 K  
LDM1-...-1000: 17 K



- optimálny koncový sušič s vysokou prevádzkovou bezpečnosťou
- vhodný pre použitie ako samostatné zariadenie alebo pre integráciu do existujúcich kombinácií zariadení pre úpravu vzduchu
- pokles rosného bodu v závislosti od prietoku

- funkcia bez opotrebovania a bez vonkajšieho prívodu energie
- zloženie stlačeného vzduchu zostáva počas procesu sušenia prakticky nezmenené
- 15 % spotreba prefukovacieho vzduchu pri LDM1-...-300/600 a 20 % pri LDM1-...-1000

Typické oblasti použitia:

- sušenie, čistenie presných dielov
- meracia technika
- preplachovanie sklenených meradiel
- lakovacie zariadenia
- papierenské a baliace stroje

- - **upozornenie**

Pre bezchybnú funkciu zariadenia je bezpodmienečne potrebná predfiltrácia stlačeného vzduchu veľmi jemným filtrom LFMA-D-MAXI, jemnosť filtra 0,1 μm (zvyškový obsah častí < 0,1 μm, zvyškový obsah oleja < 0,1 mg/m<sup>3</sup>!)

## Všeobecné technické údaje

veľkosť	Maxi		
pneumatické pripojenie 1 <sup>1)</sup>	G1/2	G3/4	G1
pneumatické pripojenie 2 <sup>1)</sup>	G1/2	G3/4	G1
prevádzkové médium	stlačený vzduch podľa ISO 8573-1:2010 [1:3:1]		
konštrukcia	membránový sušič s vlastnou spotrebou vzduchu		
spôsob upevnenia	s príslušenstvom		
	zapojenie do vedenia		
montážna poloha	zvislá ±5°		

1) s pripojovacími doskami

- - Upozornenie: Tento výrobok zodpovedá ISO 1179-1 a ISO 228-1.

## Nominálny prietok q<sub>n</sub> [l/min]

typ	LDM1-...-300 <sup>1)</sup>	LDM1-...-600 <sup>1)</sup>	LDM1-...-1000 <sup>2)</sup>
vstup q <sub>n</sub> vst	353	706	1 250
výstup q <sub>n</sub> výst	300	600	1 000
prefukovací vzduch q <sub>n</sub> pref	52,9	105,9	250

1) merané pri p<sub>1</sub> = 6,9 bar, θ<sub>pd</sub> vst = 25 °C, θ<sub>pd</sub> výst = 5 °C ± 1,5 °C (θ<sub>pA</sub> výst = -21,5 °C ± 1,2 °C), θ<sub>amb</sub> = 25 °C

2) merané pri p<sub>1</sub> = 6,9 bar, θ<sub>pd</sub> vst = 25 °C, θ<sub>pd</sub> výst = 8 °C ± 1,5 °C (θ<sub>pA</sub> výst = -19,1 °C ± 1,2 °C), θ<sub>amb</sub> = 25 °C

## Prevádzkové podmienky a podmienky okolia

typ		LDM1-...-300	LDM1-...-600	LDM1-...-1000
vstupný tlak	[bar]	3 ... 12,5		
zniženie rosného bodu	[K]	20	20	17
teplota okolia	[°C]	+2 ... +50		
teplota média	[°C]	+2 ... +50		
skladovacia teplota	[°C]	-20 ... +60		
odolnosť proti korózii	KBK <sup>1)</sup>	2		

1) Trieda odolnosti proti korózii 2 podľa normy Festo 940 070:

Konštrukčné diely s miernymi nárokmi na odolnosť proti korózii. Vonkajšie viditeľné časti s požiadavkami predovšetkým na vzhľad povrchu, ktorý je vystavený priamemu kontaktu s okolitou, pre priemysel bežnou atmosférou, prípadne kontaktu s médiami, ako sú chladiace látky a mazivá.

# Membránový sušič vzduchu LDM1, rad D, kov

FESTO

údajový list

Hmotnosti [g]				
prípoj	bez pripojovacích dosiek	s pripojovacími doskami		
		G $\frac{1}{2}$	G $\frac{3}{4}$	G1
LDM1-...-300	1 650	1 800	1 900	2 000
LDM1-...-600	2 100	2 250	2 350	2 450
LDM1-...-1000	2 100	2 250	2 350	2 450

## Materiály

funkčný rez

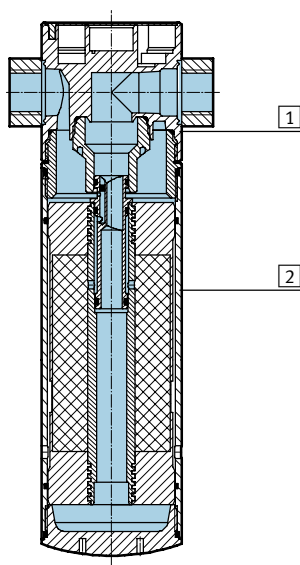

### Membránový sušič vzduchu

1	teleso	zinková tlaková liatina
2	nádoba	hliníková tvárna zliatina
-	tesnenia	nitrilový kaučuk



# Membránový sušič vzduchu LDM1, rad D, kov

údajový list

## Rosný bod $t_{pd}$ (výstup) v závislosti od normálneho prietoku na výstupe $q_n$ <sup>1)</sup>

LDM1-...-300

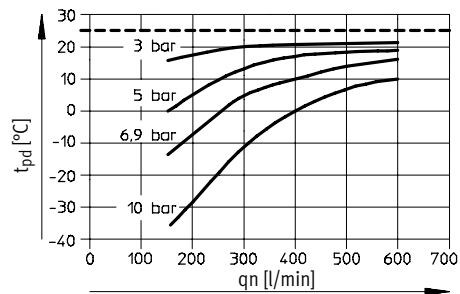

LDM1-...-600

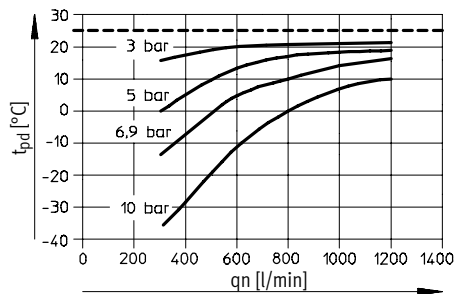

LDM1-...-1000

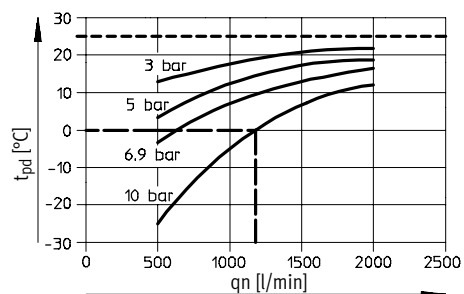

- 1) merané pri rosnom bode  $t_{pd}$  (vstup) = 25 °C.
- príklad LDM1-...-1000 so vstupným tlakom 10 bar:  
pri normálnom prietoku  $q_n = 1\,200$  l/min klesá rosný bod o 25 K.

## Diferenčný tlak $\Delta p$ v závislosti od normálneho prietoku na výstupe $q_n$

LDM1-...-300

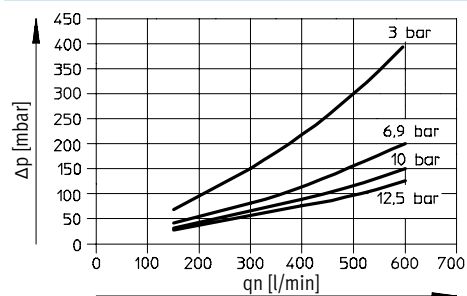

LDM1-...-600

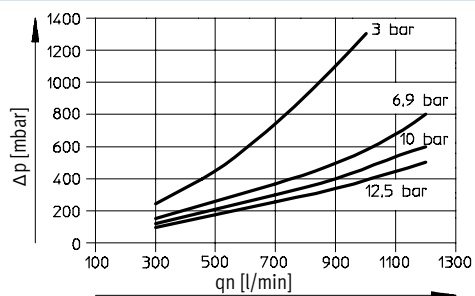

LDM1-...-1000

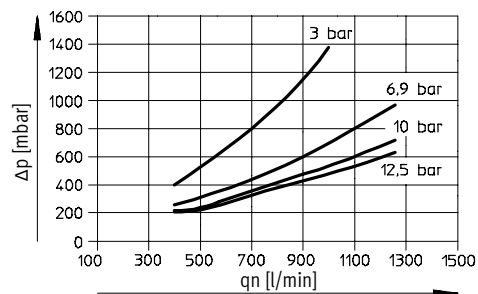

# Membránový sušič vzduchu LDM1, rad D, kov

údajový list

FESTO

Rozmery sťahovanie CAD modelov → [www.festo.sk](http://www.festo.sk)

Maxi

s pripojovacími doskami

bez pripojovacích dosiek

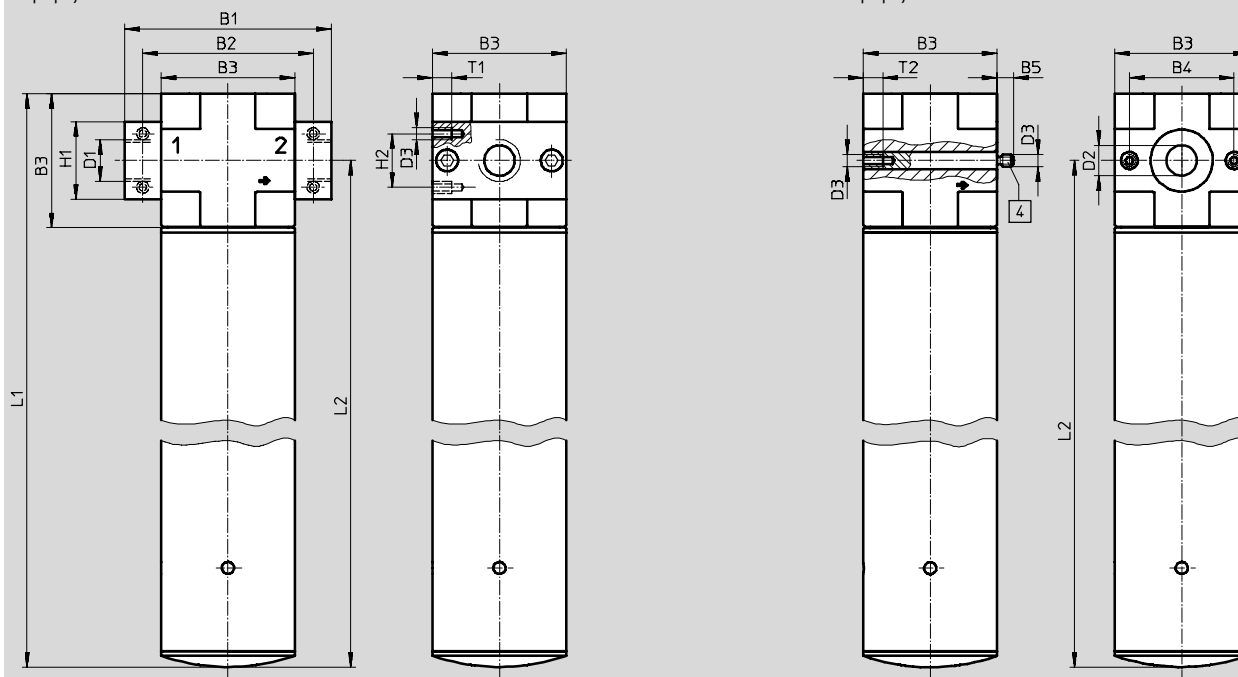

4 čap so závitom (vymeniteľný)

→ smer prietoku

typ	B1	B2	B3	B4	B5	D1	D2 Ø	D3	H1	H2	L1	L2	T1	T2
LDM1-1/2-D-MAXI-300	96	80	66	46	-	G1/2	-	M5	32	22	329	296	8	-
LDM1-1/2-D-MAXI-600											519	486		
LDM1-1/2-D-MAXI-1000											519	486		
LDM1-3/4-D-MAXI-300	96	80	66	46	-	G3/4	-	M5	36	22	329	296	8	-
LDM1-3/4-D-MAXI-600											519	486		
LDM1-3/4-D-MAXI-1000											519	486		
LDM1-1-D-MAXI-300	116	91	66	46	-	G1	-	M5	41	22	329	296	8	-
LDM1-1-D-MAXI-600											519	486		
LDM1-1-D-MAXI-1000											519	486		
LDM1-D-MAXI-300	-	-	66	46	7	-	30	M5	-	-	329	296	-	11
LDM1-D-MAXI-600											519	486		
LDM1-D-MAXI-1000											519	486		

UPOZORNENIE: Tento výrobok zodpovedá ISO 1179-1 a ISO 228-1.

## Typové označenie – bez pripojovacích dosiek

veľkosť	LDM1-...-300		LDM1-...-600		LDM1-...-1000	
	č. dielu	typ	č. dielu	typ	č. dielu	typ
Maxi	543664	LDM1-D-MAXI-300	543665	LDM1-D-MAXI-600	543666	LDM1-D-MAXI-1000

## Typové označenie – s pripojovacími doskami

veľkosť	pripoj	LDM1-...-300		LDM1-...-600		LDM1-...-1000	
		č. dielu	typ	č. dielu	typ	č. dielu	typ
Maxi	G1/2	543667	LDM1-1/2-D-MAXI-300	543668	LDM1-1/2-D-MAXI-600	543669	LDM1-1/2-D-MAXI-1000
	G3/4	543670	LDM1-3/4-D-MAXI-300	543671	LDM1-3/4-D-MAXI-600	543672	LDM1-3/4-D-MAXI-1000
	G1	543673	LDM1-1-D-MAXI-300	543674	LDM1-1-D-MAXI-600	543675	LDM1-1-D-MAXI-1000