

Parallel gripper HGPL-B, heavy-duty with long stroke

FESTO



Parallel gripper HGPL-B, heavy-duty with long stroke

Key features

At a glance

- **Sturdy**
The T-slot in combination with the long guide length allows high forces and torques
- **Space-saving**
Two parallel and opposing pistons move the gripper jaws directly and without loss of force
- **Position sensing**
Every position of the gripper jaws can be sensed using an analogue signal with the position transmitter SDAT
- **Connections for lubrication nipple**
on the top and underneath of the gripper
- **Double-acting gripper** – suitable for external and internal gripping

The technology in detail

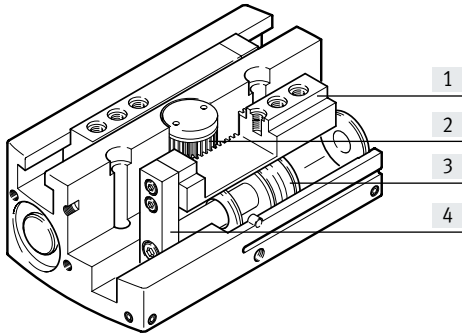

- [1] Gripper jaw
- [2] Synchronising element
- [3] Piston with magnet
- [4] Moment compensator

Note
Engineering software
Gripper selection
→ www.festo.com

Wide range of supply ports

Direct
from the front

Via adapter plate
from underneath

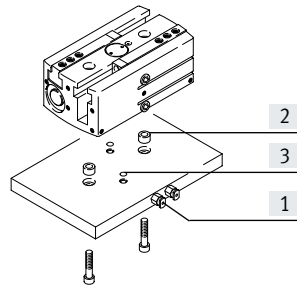
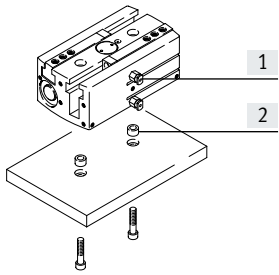

- [1] Supply ports
- [2] Centring sleeves
- [3] O-rings

Mounting options

Direct mounting
from above

from underneath

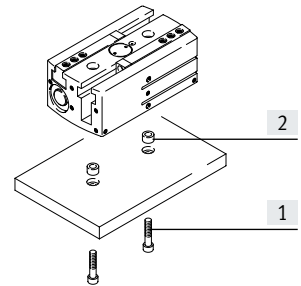
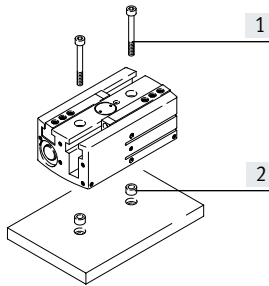

- [1] Retaining screws
- [2] Centring sleeves

Key features and type codes

Connections for lubrication nipple

Top

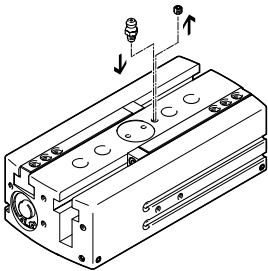

Underneath

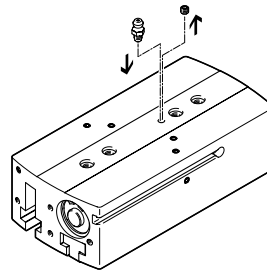

 **Note**

These grippers are not suitable for the following or similar applications:

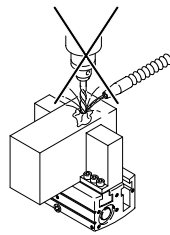

Aggressive media
Machining

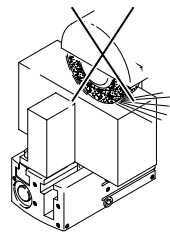

Grinding dust

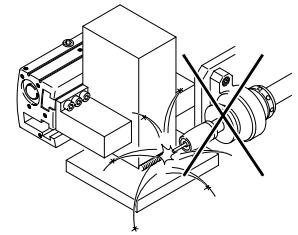

Welding spatter

Type codes

001	Series
HGPL	Parallel gripper, sturdy with long stroke

002	Size
14	14
25	25
40	40
63	63

003	Stroke per gripper jaw [mm]
20	20
40	40
60	60
80	80
100	100
150	150

004	Position sensing
A	For proximity sensor

005	Generation
B	Function-optimised

Peripherals overview

Peripherals overview

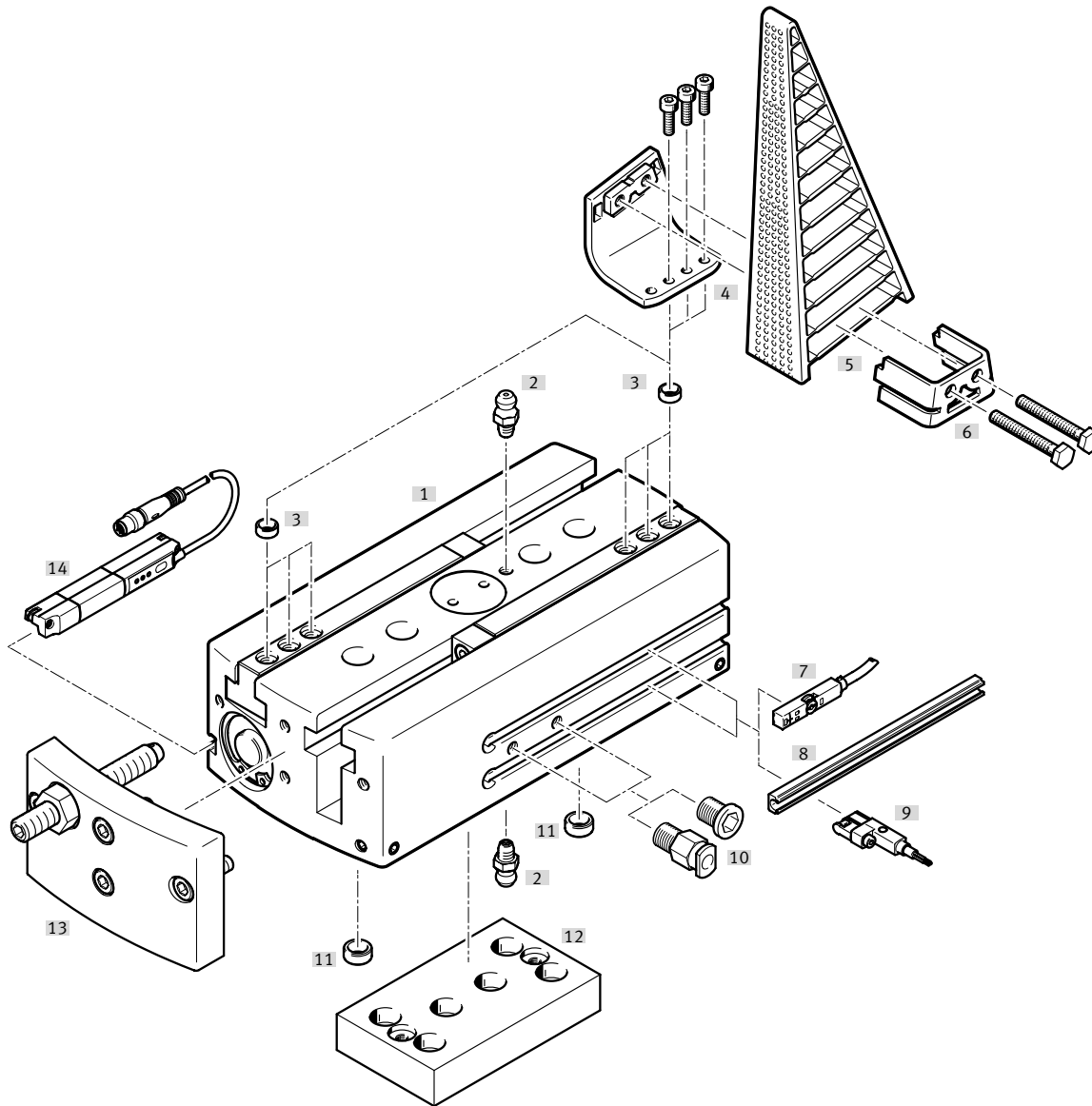

System product for handling and assembly technology

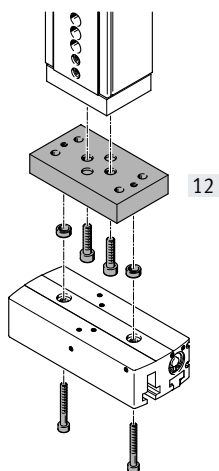

Peripherals overview

Accessories			
	Type	Description	→ Page/Internet
[1]	Parallel gripper HGPL-B	Double-acting drive, heavy-duty with long stroke	6
[2]	Lubrication nipple	<ul style="list-style-type: none"> • For relubricating the guide • 1 included in the scope of delivery 	–
[3]	Centring sleeve ZBH	<ul style="list-style-type: none"> • For centring the gripper jaw blanks/gripper fingers on the gripper jaws • 4 included in the scope of delivery 	23
[4]	Mounting bracket DHAS-MA	<ul style="list-style-type: none"> • For mounting the adaptive gripper finger DHAS-GF on the gripper • Available for size 14 	19
[5]	Adaptive gripper finger DHAS-GF	For flexible gripping	20
[6]	Mounting kit DHAS-ME	For mounting the adaptive gripper finger DHAS-GF on the mounting bracket DHAS-MA	21
[7]	Proximity switch SME/SMT-8	For sensing the piston position in the end positions	24
[8]	Sensor rail DASP	By gluing this into the sensor slot, proximity switches SME/SMT-10 can be used	25
[9]	Proximity switch SME/SMT-10	For sensing the piston position in the end positions	25
[10]	Push-in fitting QS	For connecting tubing with standard O.D.	qs
	Blanking plug B	For sealing the supply ports when using the ports at the front	23
[11]	Centring sleeve ZBH	<ul style="list-style-type: none"> • For centring the gripper during mounting • 2 included in the scope of delivery 	23
[12]	Adapter kit DHAA, HMSV, HAPG, HMVA	Drive/gripper connections	17
[13]	Stroke reduction HGPL-HR...	For reducing the opening stroke	22
[14]	Position transmitter SDAT, SMAT	<ul style="list-style-type: none"> • For sensing the piston position at any location • The position transmitter must only be inserted into this slot 	26
–	Gripper jaw blank BUB-HGPL	Blanks specially matched to the gripper jaws for custom manufacturing of gripper fingers	23

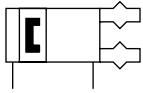

Parallel gripper HGPL-B, heavy-duty with long stroke

Datasheet

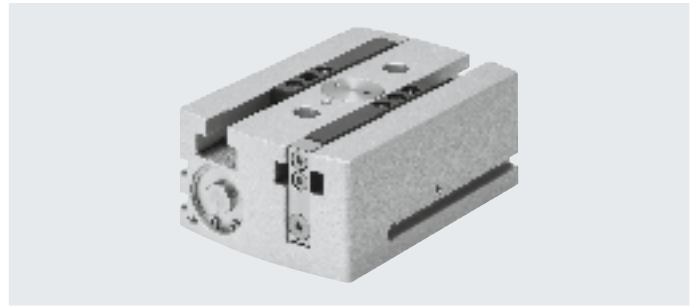

www.festo.com



-  Size
14 ... 63
-  Total stroke
40 ... 300 mm

General technical data				
Size	14	25	40	63
Design	Rack and pinion Twin piston, piston spool valve T-shape			
Operating mode	Double-acting			
Gripper function	Parallel			
Number of gripper jaws	2			
Stroke per gripper jaw [mm]	20, 40, 60, 80	20, 40, 60, 80	20, 40, 60, 80, 100	60, 100, 150
Pneumatic connection	M5 G1/8			
Max. mass per gripper finger ¹⁾ [g]	80	250	420	940
Repetition accuracy ²⁾ [mm]	< 0.03			
Max. interchangeability [mm]	< 0.2			
Max. operating frequency [Hz]	< 1			
Rotational symmetry [mm]	< \varnothing 0.2			
Position sensing	Via proximity switch			
Type of mounting	Via through-holes and centring sleeves Via female thread and centring sleeves			
Mounting position	Any			

1) Valid for unthrottled operation

2) Under constant exposure to operating conditions, end-position drift occurs in the direction of movement of the gripper jaws, at 100 consecutive strokes

Operating and environmental conditions	
Operating pressure [bar]	3 ... 8
Operating medium	Compressed air to ISO 8573-1:2010 [7:4:4]
Note on the operating/pilot medium	Lubricated operation possible (in which case lubrication will always be required)
Ambient temperature ¹⁾ [°C]	+5 ... +60
Corrosion resistance class CRC ²⁾	2

1) Note operating range of proximity switches

2) 26a normal industrial environment.

Datasheet

Weight [g]		14	25	40	63
Size					
Stroke per gripper jaw	20 mm	305	1015	2560	–
	40 mm	440	1400	3300	–
	60 mm	595	1780	4165	10460
	80 mm	720	2200	4800	–
	100 mm	–	–	5340	13800
	150 mm	–	–	–	18100

Materials

Sectional view

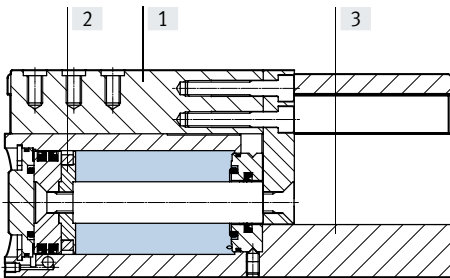

Parallel gripper

[1]	Gripper jaw	Nitrated steel
[2]	Piston	High-alloy steel
[3]	Housing	Smooth anodised aluminium
–	Seals	NBR, polyurethane
–	Note on materials	Free of copper and PTFE
		RoHS-compliant

Datasheet

Measured gripping force [N] at 6 bar (→ also graphs starting on page 11)

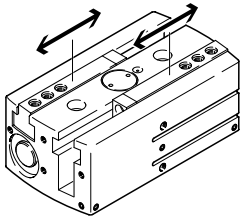

Size	14	25	40	63
Gripping force per gripper jaw				
Opening	63	206	519	1233
Closing	79	256	608	1371
Total gripping force				
Opening	126	412	1038	2466
Closing	158	512	1216	2742

Characteristic load values at the gripper jaws

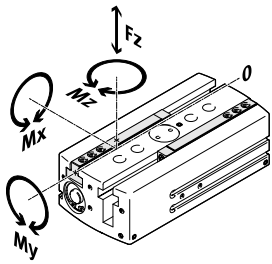

The indicated permissible forces and torques apply to a single gripper jaw. They include the lever arm, additional applied loads created by the workpiece or external gripper fingers and acceleration forces occurring during movement.

The zero co-ordinate line (gripper jaw guide groove) must be taken into consideration for the calculation of torques.

Size	14	25	40	63	
Max. permissible force F_z	[N]	500	1500	2500	9000
Max. permissible torque M_x	[Nm]	35	100	125	300
Max. permissible torque M_y	[Nm]	35	60	80	200
Max. permissible torque M_z	[Nm]	35	70	100	250

Datasheet

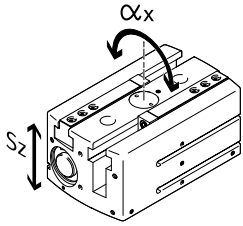
Gripper jaw backlash

The plain-bearing guide used in the grippers means that there is backlash between the gripper jaws and the housing.
The values listed in the table apply when new

Size	14	25	40	63
Gripper jaw backlash s_z [mm]	< 0.05			
Gripper jaw angular backlash α_x [°]	< 0.2			

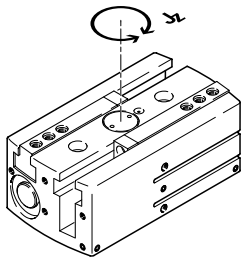
Mass moment of inertia [kgm²x10⁻⁴]

Mass moment of inertia of the parallel gripper in relation to the central axis, without external gripper fingers, without load.

Size	14	25	40	63	
Stroke per gripper jaw	20 mm	1.40	11.98	27.60	–
	40 mm	6.69	18.88	66.83	–
	60 mm	11.43	39.95	118.30	470.07
	80 mm	21.93	78.70	198.87	–
	100 mm	–	–	318.25	1018.17
	150 mm	–	–	–	2247.54

Datasheet

Opening and closing times [ms] at 6 bar

Without external gripper fingers

With external gripper fingers

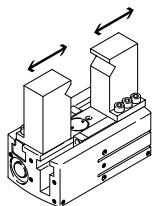
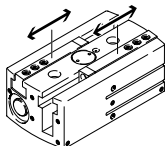

The indicated opening and closing times [ms] were measured at room temperature at an operating pressure of 6 bar with a horizontally mounted gripper without additional gripper fingers. The grippers must be throttled for larger loads [g]. Opening and closing times must then be adjusted accordingly.

Size	14				25			
Stroke [mm]	20	40	60	80	20	40	60	80
Without external gripper fingers								
Opening times	120	171	270	286	170	225	370	423
Closing times	110	163	230	270	150	230	370	418
Max. permissible opening and closing times with external gripper fingers (as a function of the weight per gripper finger)								
Weight of the gripper fingers	100 g	123	192	257	243	–	–	–
	200 g	174	272	364	343	–	–	–
	300 g	213	333	445	420	164	210	405
	400 g	246	385	514	485	190	243	468
	500 g	–	–	–	–	212	272	523

Size	40					63			
Stroke [mm]	20	40	60	80	100	60	100	150	
Without external gripper fingers									
Opening times	190	238	430	414	620	410	650	1020	
Closing times	180	205	430	438	690	330	600	850	
Max. permissible opening and closing times with external gripper fingers (as a function of the weight per gripper finger)									
Weight of the gripper fingers	500 g	196	260	469	478	676	–	–	
	600 g	215	284	514	524	741	–	–	
	700 g	232	307	555	565	800	–	–	
	800 g	248	328	593	604	856	–	–	
	900 g	–	–	–	–	–	323	587	
	1000 g	–	–	–	–	–	340	619	
	1100 g	–	–	–	–	–	357	649	
	1200 g	–	–	–	–	–	373	678	

Datasheet

Gripping force F_h per gripper jaw as a function of the operating pressure and lever arm x

The gripping forces as a function of the operating pressure and lever arm can be determined from the following graphs.

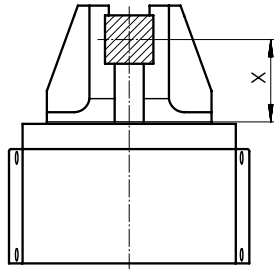

External gripping (closing)

HGPL-14

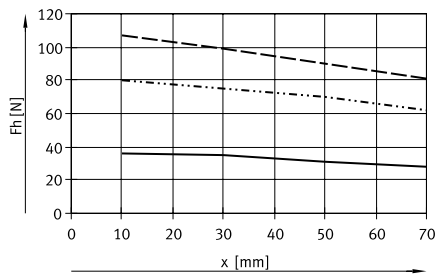

HGPL-25

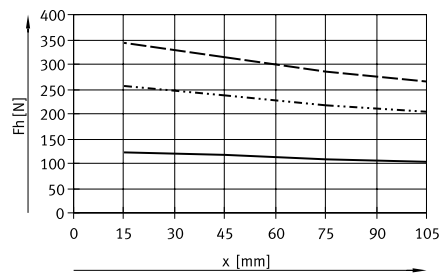

HGPL-40

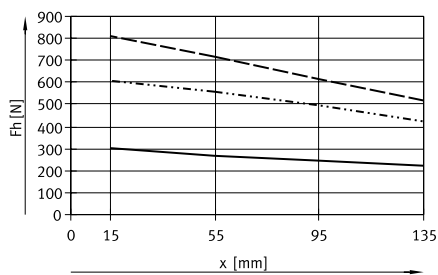

HGPL-63

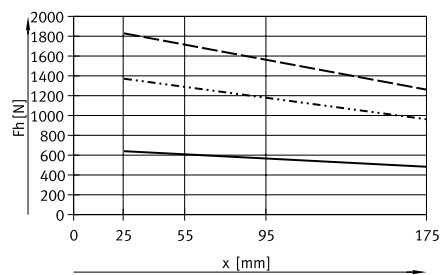

- 3 bar
- · - · - 6 bar
- - - 8 bar

Datasheet

Gripping force F_h per gripper jaw as a function of the operating pressure and lever arm x

The gripping forces as a function of the operating pressure and lever arm can be determined from the following graphs.

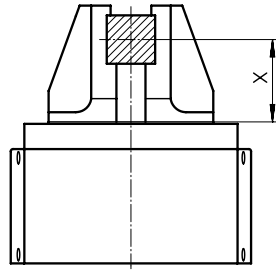

Internal gripping (opening)

HGPL-14

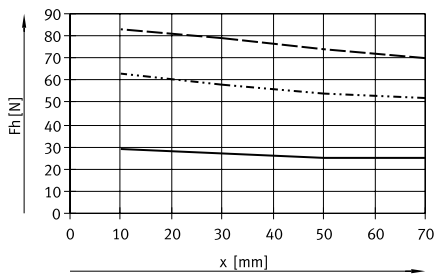

HGPL-25

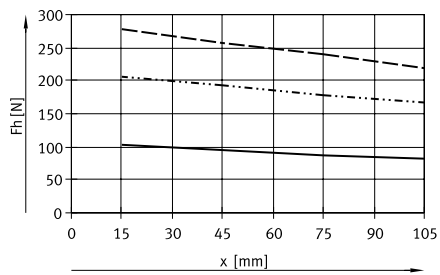

HGPL-40

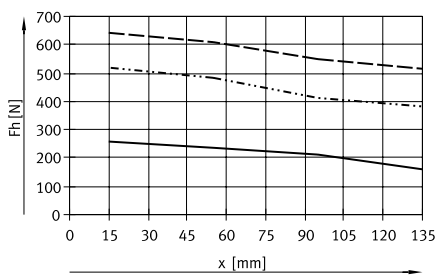

HGPL-63

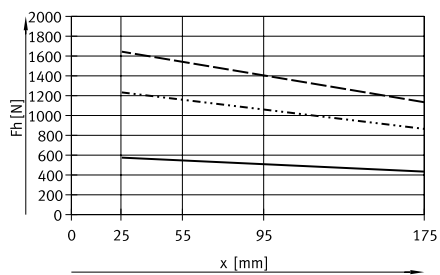

- 3 bar
- · - · - 6 bar
- - - 8 bar

Datasheet

Gripping force F_h per gripper jaw at 6 bar as a function of lever arm x and eccentricity a and b

The following formula must be used to calculate the lever arm x with eccentric gripping:

$$x = \sqrt{a^2 + b^2}$$

The gripping force F_h can be read from the graphs (→ page 11) using the calculated value x .

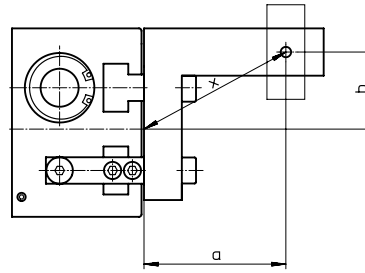

Calculation example

Assuming:

Distance $a = 45$ mm

Distance $b = 40$ mm

To be determined:

The gripping force at 6 bar with an HGPL-25, used as an external gripper

Procedure:

Calculating the lever arm x

$$x = \sqrt{45^2 + 40^2}$$

$x = 60$ mm

The graph (→ page 11) gives a value of $F_h = 225$ N for the gripping force.

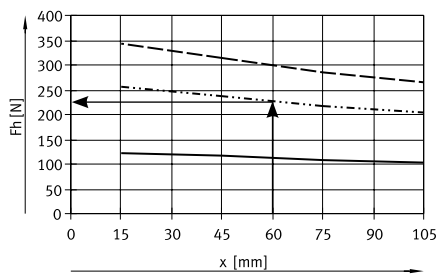

Datasheet

Dimensions

Download CAD data → www.festo.com

Size 14/25

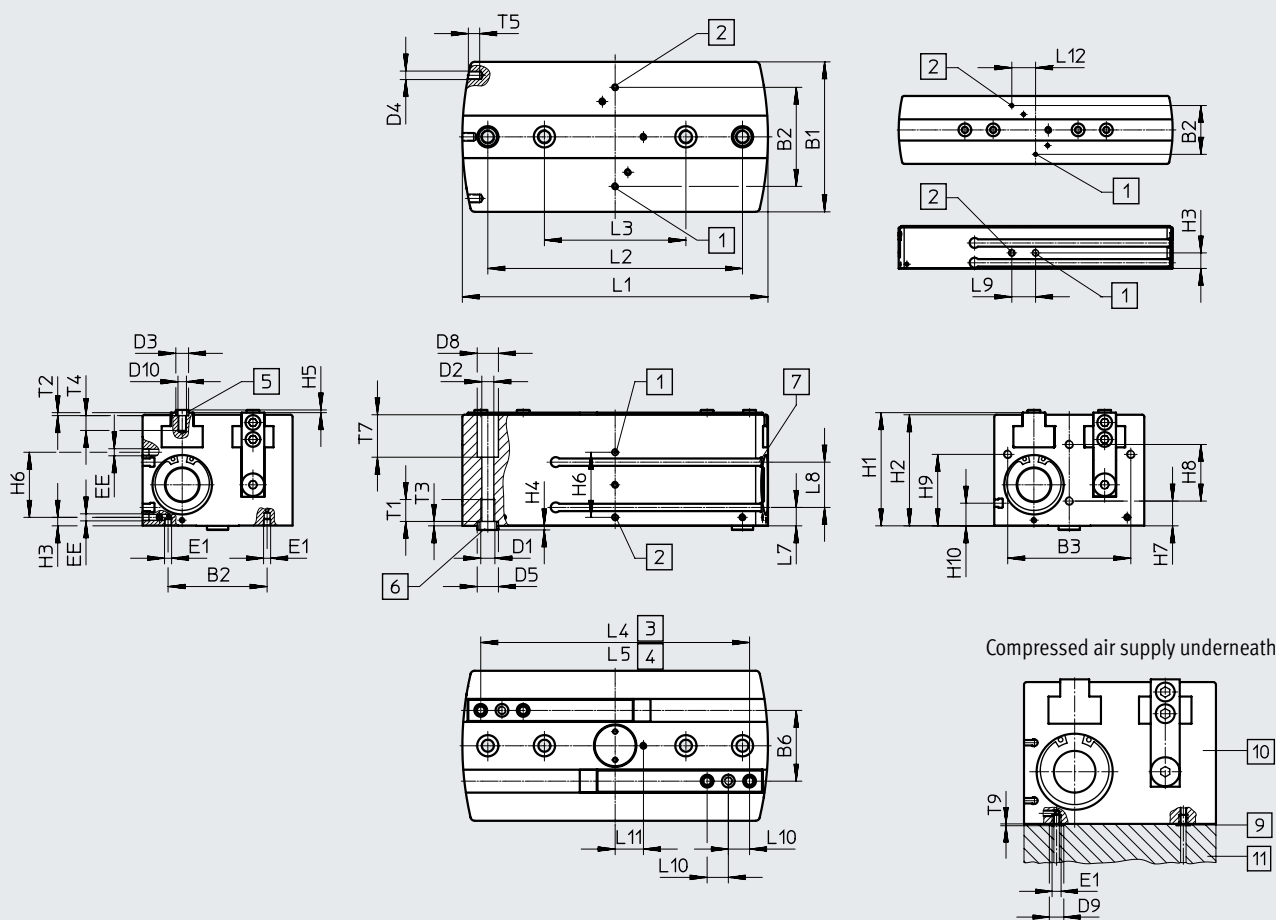

- | | | |
|---|--|---------------------------------|
| [1] Supply port, opening, either on the side or underneath (bottom connection sealed on delivery) | [3] Gripper jaws open | [9] O-ring for parallel gripper |
| [2] Supply port, closing, either on the side or underneath (bottom connection sealed on delivery) | [4] Gripper jaws closed | HGPL-14: \varnothing 3x1.5 |
| | [5] Centring sleeves ZBH (4 included in the scope of delivery) | HGPL-25: \varnothing 5x1.5 |
| | [6] Centring sleeves ZBH (2 included in the scope of delivery) | HGPL-40: \varnothing 5x1.5 |
| | [7] Slot for proximity switch | HGPL-63: \varnothing 12x1.5 |
| | | [10] Gripper |
| | | [11] Bearing surface |

Datasheet

Type	B1 ±0.05	B2	B3	B6 ±0.01	D1	D2 ∅ +0.1	D3 ∅ H8/h7	D4	D5 ∅ H8/h7	D8 ∅ H13	D9	D10	EE	E1
HGPL-14	48	34.5±0.1	40±0.2	22	M5	4.2	5	M3	9	7.4	6	M3	M5	M3
HGPL-25	80	60±0.2	65±0.1	38	M6	5.1	7	M5	9	10	8	M5	M5	M5
HGPL-40	106	70±0.2	87±0.1	50	M10	8.5	9	M6	15	15	8	M6	M5	M5
HGPL-63	154	116±0.2	130±0.1	78	M12	10.4	15	M8	15	16.5	15	M10	G1/8	G1/8

Type	H1	H2 ±0.05	H3 ±0.1	H4 -0.3	H5 -0.3	H6	H7 ±0.1	H8 ±0.1	H9 ±0.1	H10 ±0.1	L1 ±0.05	L2 ¹⁾²⁾	L3 ¹⁾²⁾	L4 ±0.5
HGPL-14-20	30	29	11	1.9	1.2	-	10	12	24.4	4	73.6	36	-	62
HGPL-14-40											113.6	60	-	102
HGPL-14-60											153.6	100	60	142
HGPL-14-80											193.6	100	60	182
HGPL-25-20	50	49	18	1.9	1.4	-	18	20	30	11	86	60	-	64
HGPL-25-40											126	60	-	104
HGPL-25-60											166	100	60	144
HGPL-25-80											206	100	60	184
HGPL-40-20	80	78.5	6	2.9	1.9	46±0.2	17.5	40	50.5	16	96	66	-	70
HGPL-40-40											136	100	-	110
HGPL-40-60											176	100	-	150
HGPL-40-80											216	180	100	190
HGPL-40-100											256	200	100	230
HGPL-63-60	121.5	120	14	2.9	2.9	60±0.1	30	58	75	28.5	190.8	100	-	160
HGPL-63-100											270	200	100	240
HGPL-63-150											370	300	100	340

Type	L5 ±0.5	L7 ±0.1	L8 ±0.1	L9	L10 ¹⁾²⁾	L11	L12 ±0.1	T1 max.	T2 +0.1	T3 +0.1	T4 min.	T5 min.	T7 +0.1	T9
HGPL-14-20	22	4.2	14	16.8±0.2	8	7.5±0.1	16.8	12.5	1.3	2.1	5.5	6.5	10	1
HGPL-14-40						9±0.1								
HGPL-14-60						9±0.1								
HGPL-14-80						9±0.1								
HGPL-25-20	24	11	14	20±0.1	10	17±0.2	20	12.5	1.6	2.1	8.5	7.5	17	1
HGPL-25-40														
HGPL-25-60														
HGPL-25-80														
HGPL-40-20	30	13	32	-	15	20±0.1	-	15.5	2.1	3.1	10.5	8	30	1
HGPL-40-40											12.6			
HGPL-40-60											10.5			
HGPL-40-80											10.5			
HGPL-40-100											10.5			
HGPL-63-60	40	28.5	30	-	22	28±0.1	-	18	3.1	3.1	17.5	12	45	1
HGPL-63-100														
HGPL-63-150														

- 1) ±0.02 for centring
2) ±0.1 for through-hole

Datasheet

Ordering data			
Size	Stroke [mm]	Part no.	Type
14			
	20	3361479	HGPL-14-20-A-B
	40	3361480	HGPL-14-40-A-B
	60	3361481	HGPL-14-60-A-B
	80	3361482	HGPL-14-80-A-B
25			
	20	3361483	HGPL-25-20-A-B
	40	3361484	HGPL-25-40-A-B
	60	3361485	HGPL-25-60-A-B
	80	3361486	HGPL-25-80-A-B
40			
	20	3361487	HGPL-40-20-A-B
	40	3361488	HGPL-40-40-A-B
	60	3361489	HGPL-40-60-A-B
	80	3361490	HGPL-40-80-A-B
	100	3361491	HGPL-40-100-A-B
63			
	60	3361492	HGPL-63-60-A-B
	100	3361493	HGPL-63-100-A-B
	150	3361494	HGPL-63-150-A-B



Accessories

Adapter kit
DHAA, HAPG, HMSV, HMVA

Material:
Wrought aluminium alloy
Free of copper and PTFE
RoHS-compliant

 **Note**
The kit includes the individual mounting interface as well as the necessary mounting material.

Download CAD data → www.festo.com

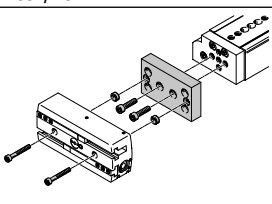
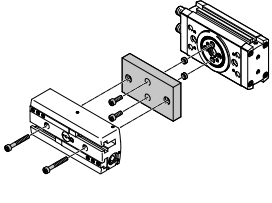
Permissible drive/gripper combinations with adapter kit							
Combination	Drive Size	Gripper Size	Mounting option		Adapter kit		
					CRC ¹⁾	Part no.	Type
DGSL/HGPL	DGSL	HGPL			DHAA, HAPG		
	16	14-20	■	■	2	2406159	DHAA-G-G6-16-B6-14
	20, 25	14-20	■	■		2410181	DHAA-G-G6-20-B6-14
	16	14-40, 14-60, 14-80	■	■		538055	HAPG-89
	20, 25	14-40, 14-60, 14-80	■	■		539274	HAPG-90
	25	25	■	■		539274	HAPG-90
	16	14-20	■	■	2	2019271	DHAA-G-Q11-16-B6-14-20
	16	14-40	■	■		2019618	DHAA-G-Q11-16-B6-14-40
	16	14-60, 14-80	■	■		2019640	DHAA-G-Q11-16-B6-14-60/80
	20	14-20	■	■		2018509	DHAA-G-Q11-20-B6-14-20
	20	14-40	■	■		2018553	DHAA-G-Q11-20-B6-14-40
	20	14-60, 14-80	■	■		2018986	DHAA-G-Q11-20-B6-14-60/80
	25	14-20	■	■		1813646	DHAA-G-Q11-25-B6-14-20
	25	14-40	■	■		1734087	DHAA-G-Q11-25-B6-14-40
	25	14-60, 14-80	■	■		2018453	DHAA-G-Q11-25-B6-14-60/80
	25	25-20, 25-40	■	■		1794882	DHAA-G-Q11-25-B6-25-20/40
	25	25-60, 25-80	■	■		2020149	DHAA-G-Q11-25-B6-25-60/80
	32	25-20, 25-40	■	■		2021733	DHAA-G-Q11-32-B6-25-20/40
	32	25-60, 25-80	■	■		2022377	DHAA-G-Q11-32-B6-25-60/80
	35	25-20, 25-40	■	■		2022892	DHAA-G-Q11-35-B6-25-20/40
	35	25-60, 25-80	■	■		2023095	DHAA-G-Q11-35-B6-25-60/80
	35, 40	40-20	■	■		2023665	DHAA-G-Q11-35/40-B6-40-20
	35, 40	40-40, 40-60	■	■		2024121	DHAA-G-Q11-35/40-B6-40-40/60
	35, 40	40-80, 40-100	■	■		2024947	DHAA-G-Q11-35/40-B6-40-80/100
	50	40-20	■	■		2387903	DHAA-G-Q11-50-B6-40-20
	50	40-40, 40-60, 40-80, 40-100	■	■		2431288	DHAA-G-Q11-50-B6-40-40/60/80/100
50	63-60, 63-100, 63-150	■	■	2431624	DHAA-G-Q11-50-B6-63-60/100/150		

1) Corrosion resistance class CRC 2 to Festo standard FN 940070
Moderate corrosion stress. Indoor applications in which condensation can occur. External visible parts with primarily decorative surface requirements that are in direct contact with a normal industrial environment.

Parallel gripper HGPL-B, heavy-duty with long stroke

Accessories



Adapter kit
DHAA, HAPG

Material:
Wrought aluminium alloy
Free of copper and PTFE
RoHS-compliant

 **Note**
The kit includes the individual mounting interface as well as the necessary mounting material.

Permissible drive/gripper combinations with adapter kit

Download CAD data → www.festo.com

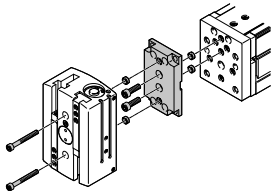
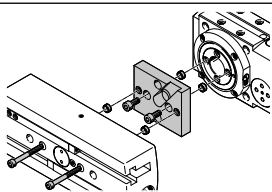
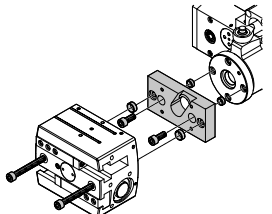
Combination	Drive Size	Gripper Size	Mounting option		Adapter kit		
					CRC ¹⁾	Part no.	Type
EGSL/HGPL	EGSL	HGPL			DHAA, HAPG		
	45, 55	14-20	■	■	2	2406159	DHAA-G-G6-16-B6-14
	75	14-20	■	■		2410181	DHAA-G-G6-20-B6-14
	45, 55	14-40, 14-60, 14-80	■	■		538055	HAPG-89
	75	14-40, 14-60, 14-80	■	■		539274	HAPG-90
	75	25	■	■		539274	HAPG-90
ERMB/HGPL	ERMB	HGPL			HAPG		
	20	14-40, 14-60, 14-80	■	■	2	537310	HAPG-SD2-31
	25, 32	25	■	■		537311	HAPG-SD2-29
EHMB/HGPL	EHMB	HGPL			DHAA, HAPG		
	25	40-20	■	■	2	2436852	DHAA-G-H2-25-B6-40
	20	25	■	■		537311	HAPG-SD2-29
	25	40-40, 40-60, 40-80, 40-100	■	■		537312	HAPG-SD2-30

1) Corrosion resistance class CRC 2 to Festo standard FN 940070

Moderate corrosion stress. Indoor applications in which condensation can occur. External visible parts with primarily decorative surface requirements that are in direct contact with a normal industrial environment.

Accessories

Mounting bracket DHAS-MA

Material: High-alloy stainless steel



Dimensions and ordering data

DHAS-MA-B6-60

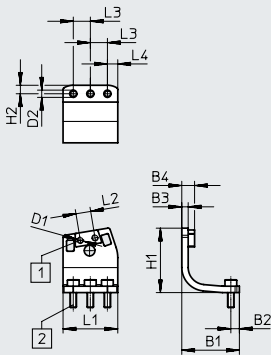

DHAS-MA-B6-80

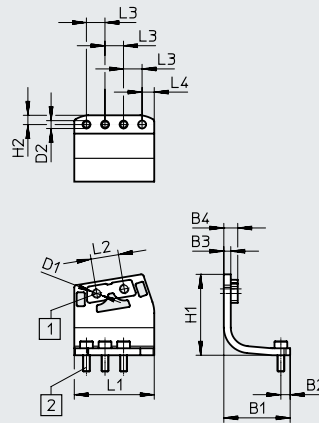

DHAS-MA-B6-120

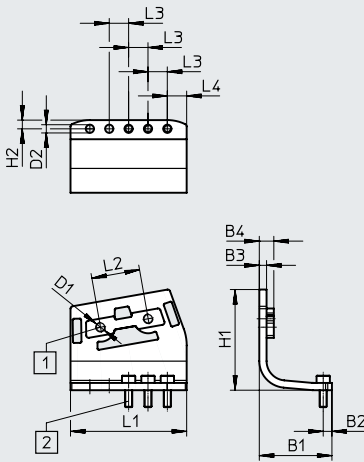

- [1] Mounting thread
- [2] Screw M3x8-8.8
(included in the scope of delivery)

For size	B1	B2	B3 ±0.2	B4 ±0.1	D1	D2 ∅	H1
14	27	4	3	6	M3	3.4	30.3
	28.6	4	3	6	M4	3.3	35
	30	3.6	3	6	M4	3.4	41.7

For size	H2	L1	L2 ±0.1	L3 ±0.1	L4	Weight [g]	Part no.	Type
14	4	25.7	7	8	4.85	23	3920696	DHAS-MA-B6-60
	4	34.5	12	8	5.25	38	3899099	DHAS-MA-B6-80
	3.6	48	20	8	7.9	59	3889257	DHAS-MA-B6-120

Parallel gripper HGPL-B, heavy-duty with long stroke

Accessories

Adaptive gripper finger DHAS-GF

Material: TPE-U (PU)

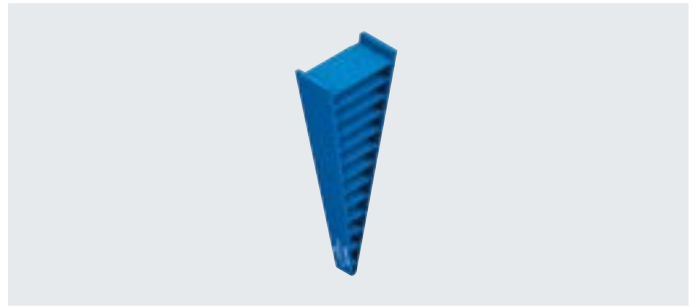

Dimensions and ordering data

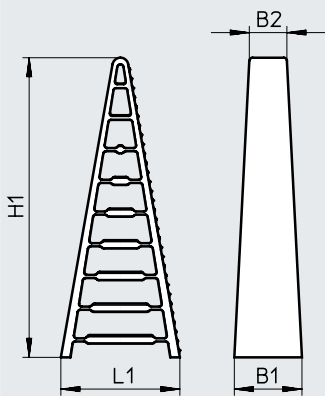

For mounting bracket	B1	B2	H1	L1	Weight [g]	Part no.	Type
DHAS-MA-B6-60	18	11.8	61.5	26	7	3998967	DHAS-GF-60-U-BU
DHAS-MA-B6-80	21.3	11.8	94.5	37.5	13	3998964	DHAS-GF-80-U-BU
DHAS-MA-B6-120	25	11.8	134.5	50	29	3998959	DHAS-GF-120-U-BU

Accessories

Mounting kit DHAS-ME

Material: High-alloy stainless steel

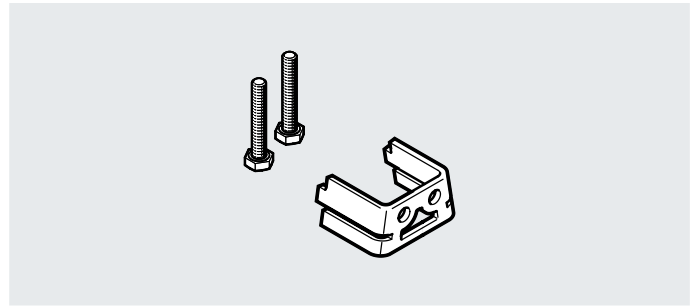

Dimensions and ordering data

DHAS-ME-H9-60/80

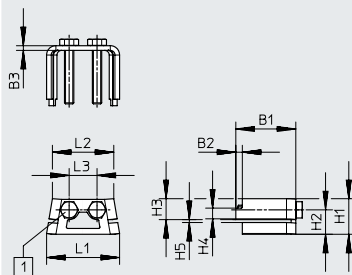

DHAS-ME-H9-120

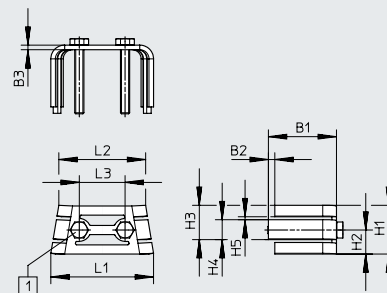

- [1] Screw (included in the scope of delivery)
 DHAS-ME-H9-60: ISO 4017-M3x22-A2-70
 DHAS-ME-H9-80: ISO 4017-M4x25-A2-70
 DHAS-ME-H9-120: ISO 4017-M4x30-A2-70

For adaptive gripper finger	B1	B2	B3 ±0.1	H1	H2	H3	H4
DHAS-GF-60-U-BU	22.8	2.8	2	10.3	6.7	7	3.6
DHAS-GF-80-U-BU	25.8	2.8	2	15.3	10.5	9	4.6
DHAS-GF-120-U-BU	29.8	2.8	2	21.3	10.5	15	8.7

For adaptive gripper finger	H5 +0.1	L1	L2	L3 ±0.1	Weight [g]	Part no.	Type
DHAS-GF-60-U-BU	1.3	20.7	17.4	7	7	4464306	DHAS-ME-H9-60
DHAS-GF-80-U-BU	1.3	31.4	26.4	12	13	4463570	DHAS-ME-H9-80
DHAS-GF-120-U-BU	1.3	44.9	38	20	23	4461433	DHAS-ME-H9-120

Accessories

Stroke reducing kit HGPL-HR

Material:
Aluminium
Free of copper and PTFE

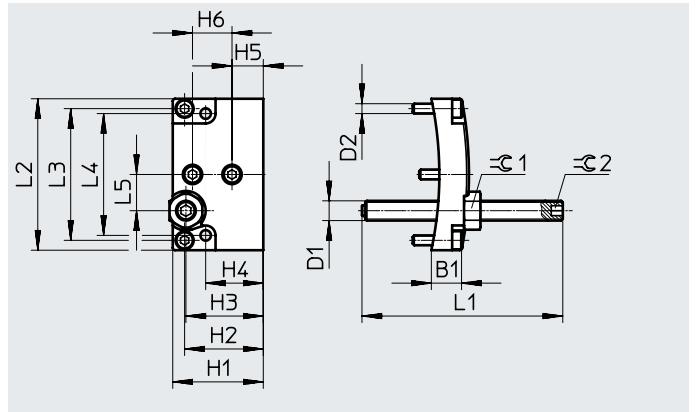

Dimensions and ordering data

For size	B1	D1	D2	H1	H2	H3	H4	H5	H6
	±0.1			±0.1	±0.1	±0.1	±0.1	±0.1	±0.1
14	9	M6	M3	27.5	23.9	23.5	17.5	9.5	12
25	12	M8	M5	47.5	-	37.5	29.5	17.5	20
40	18	M12	M6	77	-	63	50	17	40
63	19	M14	M8	118.5	-	94.5	74.5	29.5	58

For size	L1	L2	L3	L4	L5	∅G1	∅G2	Weight	Part no.	Type
	±1	±0.1	±0.1	±0.1	±0.1			[g]		
14	61	46	40	37	11	10	3	45	539092	HGPL-HR-14
25	61	77	-	65	19	13	4	150	539093	HGPL-HR-25
40	61	103	-	87	25	19	6	455	539094	HGPL-HR-40
63	81	151	-	130	39	22	6	1060	567831	HGPL-HR-63

Accessories

Gripper jaw blank BUB-HGPL

(2 included in the scope of delivery)

Material:

Aluminium

Free of copper and PTFE

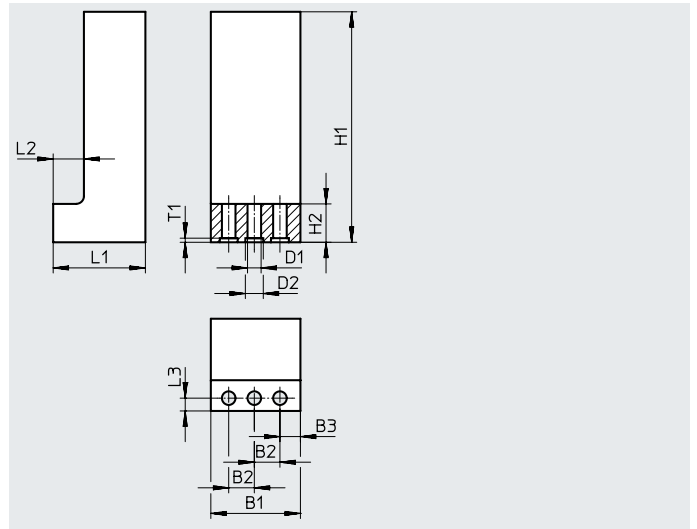

Dimensions and ordering data

For size	B1	B2	B3	D1 ∅	D2 ∅	H1	H2
	±0.1	+0.02		+0.1	H8	±0.1	
14	25	8	4	3.2	5	80	11
25	35	10	8	5.3	7	120	15
40	50	15	10	6.4	9	150	18
63	68	22	12	10.5	15	200	20

For size	L1	L2	L3	T1	Weight per blank [g]	Part no.	Type
	±0.1	+0.1	+0.1	+0.1			
14	20.5	8	3.3	1.3	75	537316	BUB-HGPL-14
25	36	12	5	1.6	295	537317	BUB-HGPL-25
40	49.5	16.5	8	2.1	720	537318	BUB-HGPL-40
63	77	27	12	3.1	1960	567830	BUB-HGPL-63

Ordering data

	For size	Weight [g]	Part no.	Type	PU ¹⁾
Centring sleeve for the gripper jaws ZBH Datasheets → Internet: zbh					
	14	1	8146543	ZBH-5-B	10
	25	1	8146544	ZBH-7-B	
	40	1	8137184	ZBH-9-B	
	63	3	191409	ZBH-15	
Centring sleeve for the gripper ZBH Datasheets → Internet: zbh					
	14, 25	1	8137184	ZBH-9-B	10
	40, 63	3	191409	ZBH-15	
Blanking plug B Datasheets → Internet: blanking plug					
	14, 25, 40	2	174308	B-M5-B	10
	63	5	3568	B-1/8	

1) Packaging unit

Accessories

Ordering data – Proximity switch for T-slot, magneto-resistive Datasheets → Internet: smt

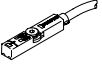
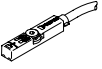
	Type of mounting	Electrical connection outlet direction of connection	Switching output	Cable length [m]	Part no.	Type
N/O						
	Inserted in the slot from above, short design	Cable, 3-core, lengthwise	PNP	2.5	574335	SMT-8M-A-PS-24V-E-2.5-OE
		Plug M8x1, 3-pin, in-line		0.3	574334	SMT-8M-A-PS-24V-E-0.3-M8D
		Plug M12x1, 3-pin, in-line		0.3	574337	SMT-8M-A-PS-24V-E-0.3-M12
		Cable, 3-core, lengthwise	NPN	2.5	574338	SMT-8M-A-NS-24V-E-2.5-OE
		Plug M8x1, 3-pin, in-line		0.3	574339	SMT-8M-A-NS-24V-E-0.3-M8D
N/C						
	Inserted in the slot from above, short design	Cable, 3-core, lengthwise	PNP	7.5	574340	SMT-8M-A-PO-24V-E-7.5-OE

Ordering data – Proximity switch for T-slot, magnetic reed Datasheets → Internet: sme

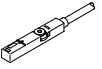
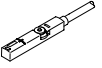
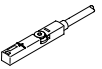
	Type of mounting	Electrical connection outlet direction of connection	Switching output	Cable length [m]	Part no.	Type
N/O						
	Inserted in the slot from above	Cable, 3-core, lengthwise	Contact- ing	2.5	543862	SME-8M-DS-24V-K-2.5-OE
				5.0	543863	SME-8M-DS-24V-K-5.0-OE
		Cable, 2-core, lengthwise		2.5	543872	SME-8M-ZS-24V-K-2.5-OE
		Plug M8x1, 3-pin, in-line		0.3	543861	SME-8M-DS-24V-K-0.3-M8D
	Inserted into the slot lengthwise	Cable, 3-core, lengthwise		2.5	150855	SME-8-K-LED-24
		Plug M8x1, 3-pin, in-line		0.3	150857	SME-8-S-LED-24
N/C						
	Inserted into the slot lengthwise	Cable, 3-core, lengthwise	Contact- ing	7.5	160251	SME-8-O-K-LED-24

Ordering data – Proximity switch for T-slot, magneto-resistive Datasheets → Internet: smt

	Type of mounting	Electrical connection, outlet direction of connection	Switching output	Cable length [m]	Part no.	Type
N/O						
	Inserted into the slot lengthwise	Cable, 3-core, crosswise	PNP	2.5	547859	SMT-8G-PS-24V-E-2.5Q-OE
		Plug M8x1, 3-pin, crosswise		0.3	547860	SMT-8G-PS-24V-E-0.3Q-M8D

Accessories

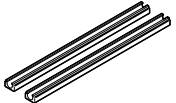

Ordering data		Description	Weight [g]	Part no.	Type	PJ ¹⁾
Sensor rail for using the proximity switch SME/SMT-10						
		<ul style="list-style-type: none"> For a gripper stroke of max. 60 mm To be glued into the slot 	6	3528767	DASP-B6-60-C-SR	2
		<ul style="list-style-type: none"> For a gripper stroke of max. 80 mm To be glued into the slot 	8	3528768	DASP-B6-80-C-SR	

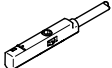
1) Packaging unit

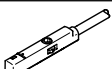
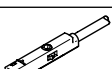
Ordering data – Proximity switch for C-slot, magneto-resistive							Datasheets → Internet: smt
	Type of mounting	Electrical connection, outlet direction of connection	Switching output	Cable length [m]	Part no.	Type	
N/O							
	Inserted in the slot from above	Cable, 3-core, lengthwise	PNP	2.5	551373	SMT-10M-PS-24V-E-2.5-L-OE	
		Plug M8x1, 3-pin, in-line		0.3	551375	SMT-10M-PS-24V-E-0.3-L-M8D	
		Cable, 3-core, crosswise		2.5	551374	SMT-10M-PS-24V-E-2.5-Q-OE	
		Plug M8x1, 3-pin, crosswise		0.3	551376	SMT-10M-PS-24V-E-0.3-Q-M8D	

Ordering data – Proximity switch for C-slot, magnetic reed							Datasheets → Internet: sme
	Type of mounting	Electrical connection, outlet direction of connection	Switching output	Cable length [m]	Part no.	Type	
N/O							
	Inserted in the slot from above	Cable, 3-core, lengthwise	Contacting	2.5	551365	SME-10M-DS-24V-E-2.5-L-OE	
		Plug M8x1, 3-pin, in-line		0.3	551367	SME-10M-DS-24V-E-0.3-L-M8D	
		Cable, 3-core, crosswise		2.5	551366	SME-10M-DS-24V-E-2.5-Q-OE	
		Plug M8x1, 3-pin, crosswise		0.3	551368	SME-10M-DS-24V-E-0.3-Q-M8D	
	Inserted into the slot lengthwise	Cable, 3-core, lengthwise		2.5	173210	SME-10-KL-LED-24	
		Plug M8x1, 3-pin, in-line		0.3	173212	SME-10-SL-LED-24	

Ordering data – Proximity switch for C-slot, magneto-resistive							Datasheets → Internet: smt
	Type of mounting	Electrical connection, outlet direction of connection	Switching output	Cable length [m]	Part no.	Type	
N/O							
	Inserted into the slot lengthwise	Cable, 3-core, crosswise	PNP	2.5	547862	SMT-10G-PS-24V-E-2.5Q-OE	
		Plug M8x1, 3-pin, crosswise		0.3	547863	SMT-10G-PS-24V-E-0.3Q-M8D	

Ordering data – Connecting cables							Datasheets → Internet: nebu
	Electrical connection, left	Electrical connection, right	Cable length [m]	Part no.	Type		
	Straight socket, M8x1, 3-pin	Cable, open end, 3-core	2.5	541333	NEBU-M8G3-K-2.5-LE3		
			5	541334	NEBU-M8G3-K-5-LE3		
	Straight socket, M12x1, 5-pin	Cable, open end, 3-core	2.5	541363	NEBU-M12G5-K-2.5-LE3		
			5	541364	NEBU-M12G5-K-5-LE3		
	Angled socket, M8x1, 3-pin	Cable, open end, 3-core	2.5	541338	NEBU-M8W3-K-2.5-LE3		
			5	541341	NEBU-M8W3-K-5-LE3		
	Angled socket, M12x1, 5-pin	Cable, open end, 3-core	2.5	541367	NEBU-M12W5-K-2.5-LE3		
			5	541370	NEBU-M12W5-K-5-LE3		

Accessories

Position transmitter

The position transmitter continuously senses the position of the piston.

It has an analogue output with an output signal that is proportional to the gripper jaw position.

Ordering data – Position transmitter for T-slot

Datasheets → Internet: position transmitter

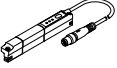
	Position measuring range	Analogue output		Type of mounting	Electrical connection	Cable length [m]	Part no.	Type
		[V]	[mA]					
	0 ... 50	–	0 ... 20	Inserted in the slot from above	Plug M8x1, 4-pin, in-line	0.3	1531265	SDAT-MHS-M50-1L-SA-E-0.3-M8
	0 ... 80							SDAT-MHS-M80-1L-SA-E-0.3-M8
	0 ... 100							SDAT-MHS-M100-1L-SA-E-0.3-M8
	0 ... 125							SDAT-MHS-M125-1L-SA-E-0.3-M8
	0 ... 160							SDAT-MHS-M160-1L-SA-E-0.3-M8

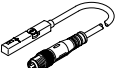

Ordering data – Position transmitter for T-slot

Datasheets → Internet: position transmitter

	Position measuring range	Analogue output		Type of mounting	Electrical connection	Cable length [m]	Part no.	Type
		[V]	[mA]					
	0 ... 40	0 ... 10		Inserted in the slot from above	Plug M8x1, 4-pin, in-line	0.3	553744	SMAT-8M-U-E-0.3-M8D

Ordering data – Connecting cables

Datasheets → Internet: nebu

	Electrical connection, left	Electrical connection, right	Cable length	Part no.	Type
			[m]		
	Straight socket, M8x1, 4-pin	Cable, open end, 4-core	2.5	541342	NEBU-M8G4-K-2.5-LE4
			5	541343	NEBU-M8G4-K-5-LE4
	Angled socket, M8x1, 4-pin	Cable, open end, 4-core	2.5	541344	NEBU-M8W4-K-2.5-LE4
			5	541345	NEBU-M8W4-K-5-LE4