









- Pre presné a šetrné premiestňovanie materiálu
- Ľahké a robustné
- 6 typov prísaviek rôznych veľkostí
- Prísavky \varnothing 2-100 mm
- dlhá životnosť

Prísavka ESS

prehľad dodávok



FESTO

typ	prísavka Ø [mm]	držiačky prísavky vel'kosť	upevňovací závit	nominálna šírka [mm]	materiály						→ strana				
					fluórový kaučuk	nitrilový kaučuk	nitrilový kaučuk antistatický	silikón	polyuretán	polyuretán odolnosť proti					
Standard, okrúhly tvar ESS-...-S...		2	1	Ø 3	0,6	■	■	■	■	■	-	6 / 2.1-53			
		4				■	■	■	■	■	-				
		6	2	Ø 4	2,0	■	■	■	■	■	-				
		8				■	■	■	■	■	-				
		10	3	M4x0,7	2,0	■	■	■	■	■	-	6 / 2.1-53			
		15				■	■	■	■	■	-				
		20				4	M6x1	3,0	■	■	■		■	■	-
		30	■	■	■				■	■	-				
		40	5	M10x1,5	6,0				■	■	■		■	■	-
		50							■	■	■		■	■	-
		60	6	M20x2	10,0	■	■	■	■	■	■		-		
		80				■	■	■	■	■	-				
100		■				■	■	■	■	-					
150		■				■	■	■	■	-					
200	■	■	■	■	■	-									
okrúhly tvar, extra hlboká ESS-...-S...		15	3	M4x0,7	2,0	■	■	-	■	■	-	6 / 2.1-57			
		20	4	M6x1	3,0	■	■	-	■	■	-				
		30				■	■	-	■	■	-				
		40				5	M10x1,5	6,0	■	■	-		■	■	-
		50	■	■	-				■	■	-				
		60	■	■	-				■	■	-				
		80	■	■	-	■	■	-							
100	■	■	-	■	■	-									
vlnovec, kruhový tvar, 1,5-násobný ESS-...-B...		10	3	M4x0,7	2,0	-	■	-	■	■	-	6 / 2.1-60			
		20	4	M6x1	3,0	-	■	-	■	■	-				
		30				■	■	-	■	■	-				
		40				5	M10x1,5	6,0	-	■	-		■	■	-
		50	■	■	-				■	■	-				
80	■	■	-	■	■	-									
vlnovec, kruhový tvar, 1,5-násobný ESS-...-BT...		40	4	M6	2,5	-	-	-	-	-	■	6 / 2.1-62			
				M10		-	-	-	-	-	■				
				G¼-l		-	-	-	-	-	■				
		50	4	M6	2,5	-	-	-	-	-	-		■		
				M10		-	-	-	-	-	■				
				G¼-l		-	-	-	-	-	■				
	80	5	M10	2,5	-	-	-	-	-	-	■				
			G¼-l		-	-	-	-	-	■					
			G¼		-	-	-	-	-	■					
	vlnovec, okrúhly tvar, 3,5-násobný ESS-...-C...		10	3	M4x0,7	2,0	-	■	-	■	-		-	6 / 2.1-64	
			20	4	M6x1	3,0	-	■	-	■	-		-		
			30				■	■	-	■	-		-		
40			■				■	-	■	-	-				
50			■				■	-	■	-	-				

Prísavka ESS

prehľad dodávok







FESTO

typ	prísavka Ø resp. veľkosť prísavky [mm]	držiačky prísavky veľkosť	upevňovací závit	nominálna šírka [mm]	materiály		→ strana		
					nitrilový kaučuk	polyuretán odolný proti teplote			
prísavka, oválny tvar ESS-...-0...		4x10	4	M6x1	3,0	■	-	6 / 2.1-66	
		4x20							
		6x10							
		6x20							
		8x20							
		8x30							
		10x30							
		15x45	5	M10x1,5	6,0	■	-		
		20x60							
		25x75							
30x90									
zvonovitý tvar ESS-...-GT-...		30	4	M6	2,5	-	■	6 / 2.1-68	
				M10					
				G1/8-l					
				G1/8					
		40	4	M6	2,5	-	■		
									M10
									G1/4-l
									G1/4
		50	4	M6	2,5	-	■		
									M10
									G1/8-l
									G1/8
		60	5	M10	2,5	-	■		
									G1/4-l
									G1/4
		80	5	M10	5,5	-	■		
									G1/4-l
									G1/4
		100	5	M10	5,5	-	■		
									G1/4-l
G1/4									

Kalíškové přísavky ESV

prehľad dodávok

FESTO

typ	prísavka Ø [mm]	držiačky prísavky veľkosť	upevňovací závit	materiály						→ strana		
				fluórový kaučuk	nitrilový kaučuk	nitrilový kaučuk antistatické	silikón	polyuretán	polyuretán odolnosť proti			
Standard, okrúhly tvar ESV-...-S...		20	4	M6x1	■	■	■	■	■	-	6 / 2.1-53	
		30			■	■	■	■	-			
		40			■	■	■	■	-			
		50			■	■	■	■	-			
	60	5	M10x1,5	■	■	-	■	■	-			
				80	■	■	-	■	■	-		
				100	■	■	-	■	■	-		
				150	■	■	-	■	■	-		
200	6	M20x2	■	■	-	■	■	-				
okrúhly tvar, extra hlboká ESV-...-E...		20	4	M6x1	■	■	-	■	■	-	6 / 2.1-57	
		30			■	■	-	■	■	-		
		40			■	■	-	■	■	-		
		50			■	■	-	■	■	-		
	60	5	M10x1,5	■	■	-	■	■	-			
				80	■	■	-	■	■	-		
				100	■	■	-	■	■	-		
vlnovec, okrúhly tvar, 1,5-násobný ESV-...-B...		20	4	M6x1	-	■	-	■	■	-	6 / 2.1-60	
		30			-	■	-	■	■	-		
		40			-	■	-	■	■	-		
		50			-	■	-	■	■	-		
	80	5	M10x1,5	-	■	-	■	■	-			
vlnovec, okrúhly tvar, 1,5-násobný ESV-...-BT...		40	4	-	-	-	-	-	-	■	6 / 2.1-62	
		50			-	-	-	-	-	■		
		80	5	-	-	-	-	-	-	■		
vlnovec, okrúhly tvar, 3,5-násobný ESV-...-C...		20	4	M6x1	-	■	-	■	-	-	6 / 2.1-64	
		30			-	■	-	■	-	-		
		40			-	■	-	■	-	-		
		50	5	M10x1	-	■	-	■	-	-		
zvonovitý tvar ESV-...-GT...		30	4	-	-	-	-	-	-	■	6 / 2.1-68	
		40			-	-	-	-	-	■		
		50			-	-	-	-	-	■		
		60	5	-	-	-	-	-	-	■		
					80	-	-	-	-	-		■
					100	-	-	-	-	-		■

Prísavky ESS/kalíškové prísavky ESV

legenda k typovému značeniu

FESTO

ESS		10	S	N	M6
typ					
ESS	prísavka				
ESV	kalíšková prísavka				
prísavka Ø resp. veľkosť prísavky [mm]					
2...200	kruhový tvar				
4x10	oválny tvar				
4x20	oválny tvar				
6x10	oválny tvar				
6x20	oválny tvar				
8x20	oválny tvar				
8x30	oválny tvar				
10x30	oválny tvar				
15x45	oválny tvar				
20x60	oválny tvar				
25x75	oválny tvar				
30x90	oválny tvar				
typ prísavky					
S	Standard, okrúhly tvar				
E	extra hlboká				
B	vlnovec, kruhový tvar, 1,5-násobný				
C	vlnovec, kruhový tvar, 3,5-násobný				
O	oválny tvar				
G	zvonovitý tvar				
materiály					
F	fluórový kaučuk				
N	nitrilový kaučuk				
NA	nitrilový kaučuk antistatický				
S	silikón				
U	polyuretán				
T	polyuretán, odolné proti vysokým teplotám				
pripojovacie závit					
M6	závit M6				
M10	závit M10				
G $\frac{1}{8}$	závit G $\frac{1}{8}$				
G $\frac{1}{4}$	závit G $\frac{1}{4}$				
G $\frac{1}{8}$ -I	vnútorný závit G $\frac{1}{8}$ -I				
G $\frac{1}{4}$ -I	vnútorný závit G $\frac{1}{4}$ -I				

-  - upozornenie

Možné kombinácie nájdete
v údajoch pre objednávky.

Prísavky ESS/kalíškové přísavky ESV

technické údaje

FESTO

Všeobecné technické údaje						
typ	ESS/ESV-...					
	F	N	NA	S	U	T
prevádzkové médium	atmosférický vzduch					
montážna poloha	ľubovoľná					
materiál	fluórový kaučuk	nitrilový kaučuk	nitrilový kaučuk antistatický	silikón	polyuretán	polyuretán, odolnosť proti vysokým teplotám
tvrdosť Shore	60±5	50±5	50±5	50±5	60±5	72±5
farba	sivá	čierna	čierna s bielym bodom	priehľadná	modrá	červenohnedá
poznámka o materiále	bez obsahu LABS			Obsahuje LABS látky		bez obsahu LABS
	bez obsahu medi, PTFE a silikónu → typové označenie					

Podmienky okolia						
typ	ESS/ESV-...					
	F	N	NA	S	U	T
teplota okolia [°C]	-10 ... +200	-10 ... +70	-10 ... +70	-30 ... +180	-20 ... +60	-10 ... +80
odolnosť proti korózii KBK ¹⁾	1					2

- 1) Trieda odolnosti proti korózii 1 podľa normy Festo 940 070
 Konštrukčné diely s nízkymi nárokmi na odolnosť proti korózii. Ochrana pri preprave a skladovaní. Diely bez požiadaviek na vzhľad povrchu, určené napr. do skrytých vnútorných priestorov alebo zadné kryty.
 Trieda odolnosti proti korózii 2 podľa normy Festo 940 070
 Konštrukčné diely s miernymi nárokmi na odolnosť proti korózii. Vonkajšie viditeľné časti s požiadavkami predovšetkým na vzhľad povrchu, ktorý je vystavený priamemu kontaktu s okolitou pre priemysel bežnou atmosférou prípadne kontaktu s médiami, ako sú chladiace látky a mazivá.

Prísavky ESS/kalíškové prísavky ESV, Standard, okrúhly tvar

FESTO

technické údaje

ESS-...-S...
ESV-...-S...

• - teplotný rozsah
-30 ... +200 °C

Funkcia

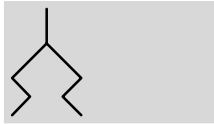

• - priemer
2 ... 200 mm

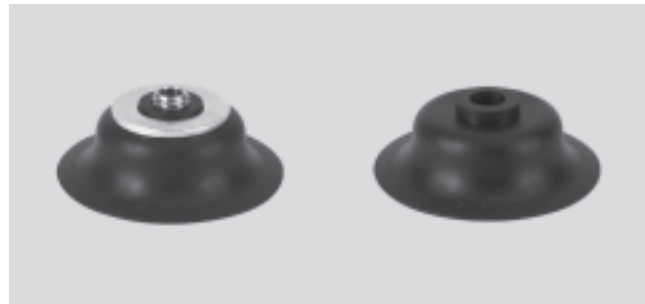

Všeobecné technické údaje								
prísavka Ø [mm]	držiak prísavky vhodný pre	upevňovací závit	prísavka, účinný Ø [mm]	odtrhávacia sila pri -0,7 bar [N]	objem prísavky ³⁾ [cm ³]	min. polomer R ²⁾ opracovávaného dielu [mm]	hmotnosť	
							ESS [g]	ESV [g]
2	vel'kost' 1	Ø 3 ¹⁾	1,4	0,1	0,002	10	0,1	-
4			3,3	0,4	0,008	10	0,1	-
6	vel'kost' 2	Ø 4 ¹⁾	5,2	1,1	0,015	15	0,2	-
8			7,2	2,3	0,030	20	0,2	-
10	vel'kost' 3	M4x0,7	8,3	3,9	0,050	30	1,5	-
15			13,5	8,5	0,208	35	1,9	-
20	vel'kost' 4	M6x1	17,6	16,3	0,318	60	6,4	1,6
30			18,4	40,8	0,867	110	9	2,7
40			26,5	69,6	1,566	230	16,3	7,4
50			33,3	105,8	2,387	330	22	11,2
60	vel'kost' 5	M10x1,5	42,0	166,1	3,953	350	49	22
80			57,8	309,7	19,312	400	133	33
100			75,2	503,6	29,779	460	222	59
150	vel'kost' 6	M20x2	114,3	900	173,826	480	719	361
200			151,7	1 610	245,454	680	1 198	840

- 1) do držiacu prísavky sa nasúva resp. nasadzujú
- 2) minimálny polomer zaoblenia uchopovaného dielu
- 3) objem pre odsávanie

Pričná sila F [N] pri pu = -0,7 bar; Ra = 7 µm					
prísavka Ø [mm]	ESS-...-SN	ESS-...-SS	ESS-...-SU	ESS-...-SF	ESS-...-SNA
2	0,5	0,5	0,5	0,5	0,5
4	0,5	0,5	0,5	0,5	0,5
6	3,5	2,5	3	1,5	2
8	9,5	3,5	5	3,5	4
10	3,5	4	7	4,5	7,5
15	10,5	6,5	9	10,5	13,5
20	11,5	10,5	23	15,5	14,5
30	19,5	23,5	19	22	20
40	60	25	83	25	49
50	135	84	130	69,5	81,5
60	136	85	151	117,5	-
80	315	104	295	139,5	-
100	600	130	482,5	299	-
150	675	400	1 000	480	-
200	850	425	1 000	500	-

Prísavky ESS/kališkové prísavek ESV, Standard, okrúhly tvar

technické údaje



Rozmery

ESS-2/4-S

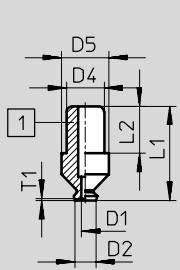

ESS-6/8-S

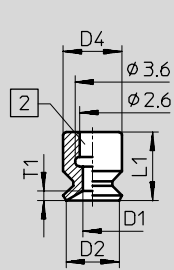

ESS-10/15-S

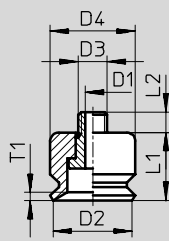

ESS-20/30-S

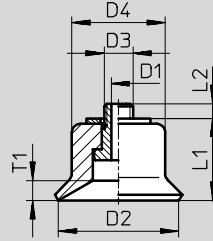

ESS-40/50/60-S

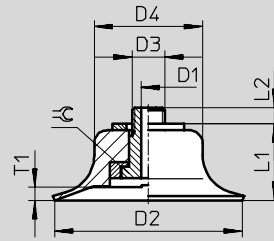

ESS-80/100-S

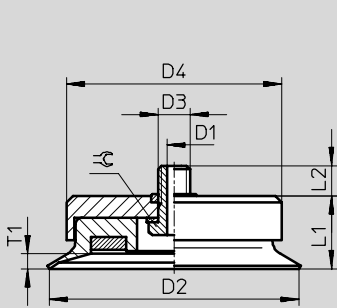

ESS-150/200-S

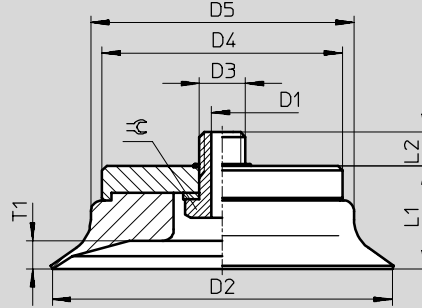

- 1 čap pre zasunutie do držiaka
- 2 otvor pre nasadenie na držiak

Prísavky

2.1

typ prísavek	pre držiak	D1 Ø NW	D2 Ø	D3	D4 Ø	D5 Ø	L1	L2	T1	☞
ESS-2-S...	ESG-2-S...	0,6	2	-	3,2	4	8	4	0,2	-
ESS-4-S...	ESG-4-S...	1,2	4	-	3,2	4	8	4	0,6	-
ESS-6-S...	ESG-6-S...	2	6	-	6	-	7	-	1	-
ESS-8-S...	ESG-8-S...	2	8	-	6	-	5,5	-	1,1	-
ESS-10-S...	ESG-10-S...	2	10	M4x0,7	10	-	8	3	1	-
ESS-15-S...	ESG-15-S...	2	15	M4x0,7	11	-	9	3	2,4	-
ESS-20-S...	ESG-20-S...	3	20	M6x1	15	-	11,6	2,4	1,8	-
ESS-30-S...	ESG-30-S...	3	30	M6x1	17	-	12,6	3,4	2	-
ESS-40-S...	ESG-40-S...	3	40	M6x1	25	-	15,6	3,2	1,9	-
ESS-50-S...	ESG-50-S...	3	50	M6x1	30	-	16,6	3,2	1,6	-
ESS-60-S...	ESG-60-S...	6	60	M10x1,5	40	-	20,6	4,5	2,6	14
ESS-80-S...	ESG-80-S...	6	80	M10x1,5	68	-	23	9,4	4,7	14
ESS-100-S...	ESG-100-S...	6	100	M10x1,5	85	-	25	8,4	5,5	14
ESS-150-S...	ESG-150-S...	10	150	M20x2	105	115	45	13	12	27
ESS-200-S...	ESG-200-S...	10	200	M20x2	105	160	50	13	15	27

Prísavky ESS/kalíškové prísavek ESV, Standard, okrúhly tvar

FESTO

technické údaje

Typové označenie			
prísavka Ø [mm]	ESS		ESV
	č. dielu	typ	č. dielu typ
fluórový kaučuk F			
2	189 267	ESS-2-SF ¹⁾	–
4	189 272	ESS-4-SF ¹⁾	–
6	189 277	ESS-6-SF ¹⁾	–
8	189 282	ESS-8-SF ¹⁾	–
10	189 287	ESS-10-SF ¹⁾	–
15	189 292	ESS-15-SF ¹⁾	–
20	189 297	ESS-20-SF ¹⁾	190 982 ESV-20-SF
30	189 302	ESS-30-SF ¹⁾	190 987 ESV-30-SF
40	189 307	ESS-40-SF ¹⁾	190 992 ESV-40-SF
50	189 312	ESS-50-SF ¹⁾	190 997 ESV-50-SF
60	189 317	ESS-60-SF ¹⁾	191 002 ESV-60-SF
80	189 321	ESS-80-SF ¹⁾	191 006 ESV-80-SF
100	189 325	ESS-100-SF ¹⁾	191 010 ESV-100-SF
150	189 329	ESS-150-SF ¹⁾	191 014 ESV-150-SF
200	189 333	ESS-200-SF ¹⁾	191 018 ESV-200-SF
nitrilový kaučuk N			
2	189 264	ESS-2-SN ¹⁾	–
4	189 269	ESS-4-SN ¹⁾	–
6	189 274	ESS-6-SN ¹⁾	–
8	189 279	ESS-8-SN ¹⁾	–
10	189 284	ESS-10-SN ¹⁾	–
15	189 289	ESS-15-SN ¹⁾	–
20	189 294	ESS-20-SN ¹⁾	190 979 ESS-20-SN
30	189 299	ESS-30-SN ¹⁾	190 984 ESV-30-SN
40	189 304	ESS-40-SN ¹⁾	190 989 ESV-40-SN
50	189 309	ESS-50-SN ¹⁾	190 994 ESV-50-SN
60	189 314	ESS-60-SN ¹⁾	190 999 ESV-60-SN
80	189 318	ESS-80-SN ¹⁾	191 003 ESV-80-SN
100	189 322	ESS-100-SN ¹⁾	191 007 ESV-100-SN
150	189 326	ESS-150-SN ¹⁾	191 011 ESV-150-SN
200	189 330	ESS-200-SN ¹⁾	191 015 ESV-200-SN
nitrilový kaučuk, antistatický NA			
2	189 268	ESS-2-SNA ¹⁾	–
4	189 273	ESS-4-SNA ¹⁾	–
6	189 278	ESS-6-SNA ¹⁾	–
8	189 283	ESS-8-SNA ¹⁾	–
10	189 288	ESS-10-SNA ¹⁾	–
15	189 293	ESS-15-SNA ¹⁾	–
20	189 298	ESS-20-SNA ¹⁾	190 983 ESV-20-SNA
30	189 303	ESS-30-SNA ¹⁾	190 988 ESV-30-SNA
40	189 308	ESS-40-SNA ¹⁾	190 993 ESV-40-SNA
50	189 313	ESS-50-SNA ¹⁾	190 998 ESV-50-SNA

1) bez obsahu medi, PTFE a silikónu

Prísavky ESS/kalíškové prísavky ESV, Standard, okrúhly tvar

technické údaje

FESTO

Typové označenie				
prísavka Ø [mm]	ESS		ESV	
	č. dielu	typ	č. dielu	typ
silikón S				
2	189 266	ESS-2-SS	-	
4	189 271	ESS-4-SS	-	
6	189 276	ESS-6-SS	-	
8	189 281	ESS-8-SS	-	
10	189 286	ESS-10-SS	-	
15	189 291	ESS-15-SS	-	
20	189 296	ESS-20-SS	190 981	ESV-20-SS
30	189 301	ESS-30-SS	190 986	ESV-30-SS
40	189 306	ESS-40-SS	190 991	ESV-40-SS
50	189 311	ESS-50-SS	190 996	ESV-50-SS
60	189 316	ESS-60-SS	191 001	ESV-60-SS
80	189 320	ESS-80-SS	191 005	ESV-80-SS
100	189 324	ESS-100-SS	191 009	ESV-100-SS
150	189 328	ESS-150-SS	191 013	ESV-150-SS
200	189 332	ESS-200-SS	191 017	ESV-200-SS
polyuretán U				
2	189 265	ESS-2-SU	-	
4	189 270	ESS-4-SU	-	
6	189 275	ESS-6-SU	-	
8	189 280	ESS-8-SU	-	
10	189 285	ESS-10-SU	-	
15	189 290	ESS-15-SU	-	
20	189 295	ESS-20-SU	190 980	ESV-20-SU
30	189 300	ESS-30-SU	190 985	ESV-30-SU
40	189 305	ESS-40-SU	190 990	ESV-40-SU
50	189 310	ESS-50-SU	190 995	ESV-50-SU
60	189 315	ESS-60-SU	191 000	ESV-60-SU
80	189 319	ESS-80-SU	191 004	ESV-80-SU
100	189 323	ESS-100-SU	191 008	ESV-100-SU
150	189 327	ESS-150-SU	191 012	ESV-150-SU
200	189 331	ESS-200-SU	191 016	ESV-200-SU

Prísavky ESS/prísavky ESV, okrúhly tvar, extra hlboké

FESTO

technické údaje

ESS-...-E...
ESV-...-E...

—  — teplotný rozsah
-30 ... +200 °C

Funkcia

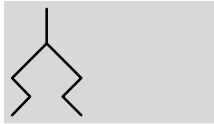

—  — priemer
15 ... 100 mm



Všeobecné technické údaje								
prísavka Ø [mm]	držiak prísavky vhodný pre	upevňovací závit	prísavka, účinný Ø [mm]	odtrhávacia sila pri -0,7 bar [N]	objem prísavky ²⁾ [cm ³]	min. polomer R ¹⁾ opracovávaného dielu [mm]	hmotnosť	
							ESS [g]	ESV [g]
15	vel'kosť 3	M4x0,7	13,8	9,8	0,350	20	1,9	–
20	vel'kosť 4	M6x1	17,2	17	0,840	30	6,4	1,6
30			20,9	37,2	2,120	50	9,2	2,9
40			28,1	67,6	4,040	80	16,9	8
50			36,9	103,6	7,900	100	23,4	12,6
60	vel'kosť 5	M10x1,5	40,5	162,5	19,770	120	48	21
80			62,7	275	51,610	160	141	41
100			78,5	440,8	84,660	200	228	65

- 1) minimálny polomer zaoblenia uchopovaného dielu
2) objem pre odsávanie

Pričná sila F [N] pri pu = -0,7 bar; Ra = 7 µm				
prísavka Ø [mm]	ESS-...-EN	ESS-...-ES	ESS-...-EU	ESS-...-EF
15	9	10	15	14,5
20	14	13	16	15,5
30	24,5	21,5	41,5	18,5
40	53	28,5	46,5	22
50	115	42,5	62	60
60	130	63,5	134	62,5
80	216	107,5	136,5	148,5
100	351	150	352,5	254,5

Prísavky ESS/prísavky ESV, okrúhly tvar, extra hlboké

technické údaje

FESTO

Rozmery

ESS-15-E

ESS-20/30-E

ESS-40/50/60-E

ESS-80/100-E

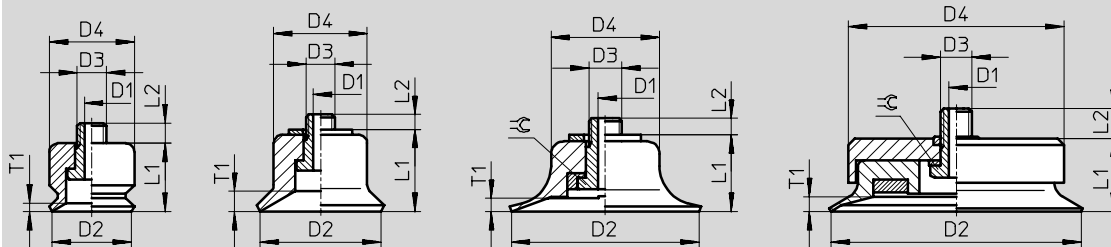

typ prísavka	pre držiak	D1 Ø NW	D2 Ø	D3	D4 Ø	L1	L2	T1	⊖
ESS-15-E...	ESG-15-E...	2	15	M4x0,7	11	10	3	2,8	-
ESS-20-E...	ESG-20-E...	3	20	M6x1	15	12,6	2,4	3	-
ESS-30-E...	ESG-30-E...	3	30	M6x1	17	15,6	3,4	4,5	-
ESS-40-E...	ESG-40-E...	3	40	M6x1	25	19,1	3,2	4,5	-
ESS-50-E...	ESG-50-E...	3	50	M6x1	30	21,1	3,7	6,5	-
ESS-60-E...	ESG-60-E...	6	60	M10x1,5	40	27,6	5,4	9,5	14
ESS-80-E...	ESG-80-E...	6	80	M10x1,5	68	33	9,4	8,6	14
ESS-100-E...	ESG-100-E...	6	100	M10x1,5	85	33	8,4	10,7	14

Prísavky ESS/prísavky ESV, okrúhly tvar, extra hlboké

technické údaje

FESTO

Typové označenie			
prísavka Ø [mm]	ESS		ESV
	č. dielu	typ	č. dielu typ
fluórový kaučuk F			
15	189 337	ESS-15-EF ¹⁾	–
20	189 341	ESS-20-EF ¹⁾	191 026 ESV-20-EF
30	189 345	ESS-30-EF ¹⁾	191 030 ESV-30-EF
40	189 349	ESS-40-EF ¹⁾	191 034 ESV-40-EF
50	189 353	ESS-50-EF ¹⁾	191 038 ESV-50-EF
60	189 357	ESS-60-EF ¹⁾	191 042 ESV-60-EF
80	189 361	ESS-80-EF ¹⁾	191 046 ESV-80-EF
100	189 365	ESS-100-EF ¹⁾	191 050 ESV-100-EF
nitrilový kaučuk N			
15	189 334	ESS-15-EN ¹⁾	–
20	189 338	ESS-20-EN ¹⁾	191 023 ESV-20-EN
30	189 342	ESS-30-EN ¹⁾	191 027 ESV-30-EN
40	189 346	ESS-40-EN ¹⁾	191 031 ESV-40-EN
50	189 350	ESS-50-EN ¹⁾	191 035 ESV-50-EN
60	189 354	ESS-60-EN ¹⁾	191 039 ESV-60-EN
80	189 358	ESS-80-EN ¹⁾	191 043 ESV-80-EN
100	189 362	ESS-100-EN ¹⁾	191 047 ESV-100-EN
silikón S			
15	189 336	ESS-15-ES	–
20	189 340	ESS-20-ES	191 025 ESV-20-ES
30	189 344	ESS-30-ES	191 029 ESV-30-ES
40	189 348	ESS-40-ES	191 033 ESV-40-ES
50	189 352	ESS-50-ES	191 037 ESV-50-ES
60	189 356	ESS-60-ES	191 041 ESV-60-ES
80	189 360	ESS-80-ES	191 045 ESV-80-ES
100	189 364	ESS-100-ES	191 049 ESV-100-ES
polyuretán U			
15	189 335	ESS-15-EU	–
20	189 339	ESS-20-EU	191 024 ESV-20-EU
30	189 343	ESS-30-EU	191 028 ESV-30-EU
40	189 347	ESS-40-EU	191 032 ESV-40-EU
50	189 351	ESS-50-EU	191 036 ESV-50-EU
60	189 355	ESS-60-EU	191 040 ESV-60-EU
80	189 359	ESS-80-EU	191 044 ESV-80-EU
100	189 363	ESS-100-EU	191 048 ESV-100-EU

1) bez obsahu medi, silikónu

Prísavky ESS/prísavky ESV, vlnovec, okrúhly tvar, 1,5-násobný

technické údaje

FESTO

ESS-...-B...
ESV-...-B...

-  - teplotný rozsah
-30 ... +180 °C

Funkcia



-  - priemer
10 ... 80 mm



Všeobecné technické údaje									
prísavka Ø [mm]	držiak prísavky vhodný pre	upevňovací závit	prísavka, účinný Ø [mm]	odtrhávacia sila pri -0,7 bar [N]	objem prísavky ²⁾ [cm ³]	min. polomer R ¹⁾ opracovávaného dielu [mm]	odpruženie H1 [mm]	hmotnosť	
								ESS [g]	ESV [g]
10	veľkosť 3	M4x0,7	7,4	4,7	0,380	20	4	1,8	-
20	veľkosť 4	M6x1	14,3	12,9	1,600	40	6	6,7	1,9
30			20,3	26,2	4,070	80	8	9,9	3,6
40			25,2	52,3	8,870	90	9,5	18,7	9,8
50	veľkosť 5	M10x1,5	31,8	72,6	14,230	150	11	24,7	13,9
80			55	213,6	63,900	430	10	139	39

- 1) minimálny polomer zaoblenia uchopovaného dielu
2) objem pre odsávanie

odpruženie H1

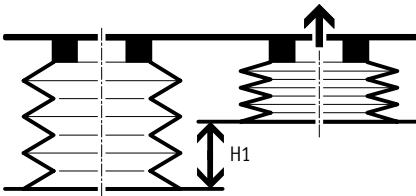

Pričná sila F [N] pri pu = -0,7 bar; Ra = 7 µm			
prísavka Ø [mm]	ESS-...-BN	ESS-...-BS	ESS-...-BU
10	4,5	2,5	3
20	9,5	8	9,5
30	24,5	16	21,5
40	32,5	32,5	33
50	55,5	38	47
80	199,5	93	132,5

Prísavky ESS/prísavky ESV, vlnovec, okrúhly tvar, 1,5-násobný

technické údaje

FESTO

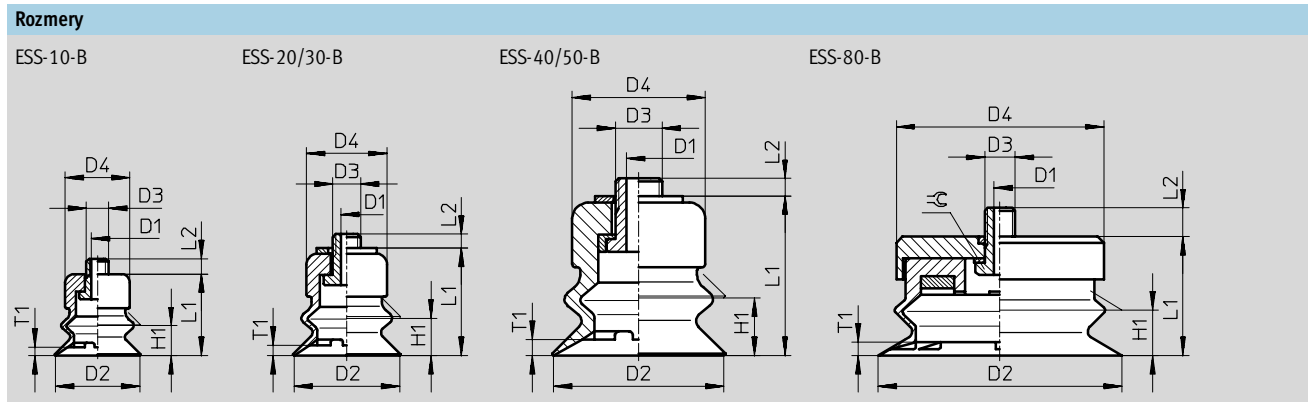

typ prísavek	pre držiak	D1 Ø NW	D2 Ø	D3	D4 Ø	H1	L1	L2	T1	⊕
ESS-10-B...	ESG-10-B...	2	10	M4x0,7	10	4	16	3	1	-
ESS-20-B...	ESG-20-B...	3	20	M6x1	15	6	20,6	2,4	2	-
ESS-30-B...	ESG-30-B...	3	30	M6x1	17	8	24,6	3,4	2,5	-
ESS-40-B...	ESG-40-B...	3	40	M6x1	25	9,5	31,6	3,2	4	-
ESS-50-B...	ESG-50-B...	3	50	M6x1	30	11	33,6	3,2	4	-
ESS-80-B...	ESG-80-B...	6	80	M10x1,5	68	10	39	9,4	2	14

Typové označenie

prísavka Ø [mm]	ESS		ESV	
	č. dielu	typ	č. dielu	typ
nitrilový kaučuk N				
10	189 374	ESS-10-BN ¹⁾	-	-
20	189 378	ESS-20-BN ¹⁾	191 054	ESV-20-BN
30	189 382	ESS-30-BN ¹⁾	191 057	ESV-30-BN
40	189 386	ESS-40-BN ¹⁾	191 060	ESV-40-BN
50	189 390	ESS-50-BN ¹⁾	191 063	ESV-50-BN
80	189 394	ESS-80-BN ¹⁾	191 066	ESV-80-BN
silikón S				
10	189 376	ESS-10-BS	-	-
20	189 380	ESS-20-BS	191 056	ESV-20-BS
30	189 384	ESS-30-BS	191 059	ESV-30-BS
40	189 388	ESS-40-BS	191 062	ESV-40-BS
50	189 392	ESS-50-BS	191 065	ESV-50-BS
80	189 396	ESS-80-BS	191 068	ESV-80-BS
polyuretán U				
10	189 375	ESS-10-BU	-	-
20	189 379	ESS-20-BU	191 055	ESV-20-BU
30	189 383	ESS-30-BU	191 058	ESV-30-BU
40	189 387	ESS-40-BU	191 061	ESV-40-BU
50	189 391	ESS-50-BU	191 064	ESV-50-BU
80	189 395	ESS-80-BU	191 067	ESV-80-BU

1) bez obsahu medi, silikónu

Prísavky ESS/prísavky ESV, vlnovec, okrúhly tvar, 1,5-násobný

technické údaje

FESTO

ESS-...-BT-...
ESV-...-BT

—  — teplotný rozsah
-10 ... +80 °C

Funkcia

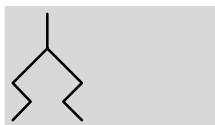

—  — priemer
40 ... 80 mm



Všeobecné technické údaje

prísavka Ø [mm]	držiak prísavky vhodný pre	upevňovací závit	odtrhávacia sila pri -0,7 bar [N]	min. polomer R ¹⁾ opracovaného dielu [mm]	objem [cm ³]	hmotnosť*	
						ESS [g]	ESV [g]
40	veľkosť 4	M6x1	59	35	9,70	18	10,5
	veľkosť 5	M10x1,5			9,71	19	
	—	G ³ / ₄ -I vnútorný závit			10,00	19	
	—	G ³ / ₄ vonkajší závit			9,73	20,5	
50	veľkosť 4	M6x1	100	40	17,50	24	16,2
	veľkosť 5	M10x1,5			17,51	25	
	—	G ³ / ₄ -I vnútorný závit			17,80	25	
	—	G ³ / ₄ vonkajší závit			17,53	26	
80	veľkosť 5	M10x1,5	237	100	58,50	84,5	57,2
	—	G ³ / ₄ -I vnútorný závit			58,50	87,5	
	—	G ³ / ₄ vonkajší závit			58,50	85,5	

1) minimálny polomer zaoblenia uchopovaného dielu

Prísavky ESS/prísavky ESV, vlnovec, okrúhly tvar, 1,5-násobný

technické údaje

FESTO

Rožmery

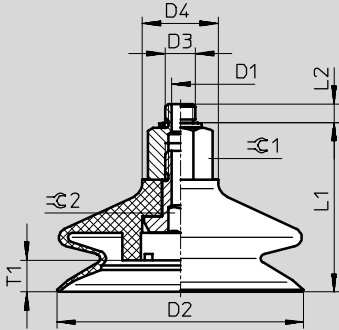

typ	D1 Ø NW	D2 Ø	D3	D4 Ø	L1	L2	T1	R1	R2
ESS-40-BT	2,5	40	M6	20	36	3,45	9	15	4
ESS-40-BT-I			M10		36,3	6,2		17	
ESS-50-BT			G¼		48,3	-		17	
ESS-50-BT-I	2,5	50	M6	20	38,05	3,45	8	15	4
ESS-50-BT			M10		38,3	6,2		17	
ESS-80-BT			G¼		50,3	-		17	
ESS-80-BT-I	2,5	80	M10	20	53,3	6,2	10,5	17	8
ESS-80-BT			G¼		60,8	5,8		17	
ESS-80-BT-I			G¼		60,8	-		17	

Typové označenie

prísavka Ø [mm]	prípoj	ESS		ESV	
		č. dielu	typ	č. dielu	typ
40	M6	525 989	ESS-40-BT-M6 ¹⁾	-	-
	M10	525 990	ESS-40-BT-M10 ¹⁾	-	-
	G¼ vnútorný závit	525 991	ESS-40-BT-G¼-I ¹⁾	-	-
	G¼	525 992	ESS-40-BT-G¼ ¹⁾	-	-
	-	-	-	526 006	ESV-40-BT ¹⁾
50	M6	525 993	ESS-50-BT-M6 ¹⁾	-	-
	M10	525 994	ESS-50-BT-M10 ¹⁾	-	-
	G¼ vnútorný závit	525 995	ESS-50-BT-G¼-I ¹⁾	-	-
	G¼	525 996	ESS-50-BT-G¼ ¹⁾	-	-
	-	-	-	526 007	ESV-50-BT ¹⁾
80	M10	525 997	ESS-80-BT-M10 ¹⁾	-	-
	G¼ vnútorný závit	525 998	ESS-80-BT-G¼-I ¹⁾	-	-
	G¼	525 999	ESS-80-BT-G¼ ¹⁾	-	-
	-	-	-	526 008	ESV-80-BT ¹⁾

1) bez obsahu medi, silikónu

Prísavky ESS/prísavky ESV, vlnovec, okrúhly tvar, 3,5-násobný

technické údaje

FESTO

ESS-...-C...
ESV-...-C...

-  - teplotný rozsah
-30 ... +180 °C

Funkcia

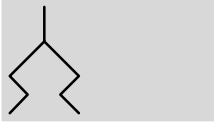

-  - priemer
10 ... 50 mm



Všeobecné technické údaje

prísavka Ø [mm]	držiak prísavky vhodný pre	upevňovací závit	prísavka, účinný Ø [mm]	odtrhávacia sila pri -0,7 bar [N]	objem prísavky ²⁾ [cm ³]	min. polomer R ¹⁾ opracovaného dielu [mm]	odpruženie H1 [mm]	hmotnosť	
								ESS [g]	ESV [g]
10	veľkosť 3	M4x0,7	6,9	3,9	0,290	25	3,3	1,6	-
20	veľkosť 4	M6x1	14,5	8,2	2,750	50	7	6,9	2,1
30			20,9	20,8	9,470	80	10,5	12,2	5,8
40			28,2	42,4	19,720	100	12,8	21,9	13
50			32,8	63,4	38,920	180	17,5	32,1	21,3

- 1) minimálny polomer zaoblenia uchopovaného dielu
2) objem pre odsávanie

Prísavky

2.1

odpruženie H1

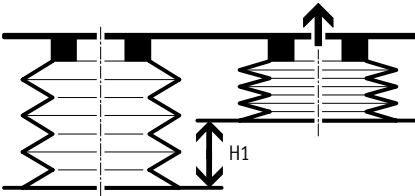

Priečna sila F [N] pri pu = -0,7 bar; Ra = 7 µm

prísavka Ø [mm]	ESS-...-CN	ESS-...-CS
10	1,5	1
20	6,5	7
30	11,5	11
40	47,5	13
50	49	45,5

Prísavky ESS/prísavky ESV, vlnovec, okrúhly tvar, 3,5-násobný

technické údaje

FESTO

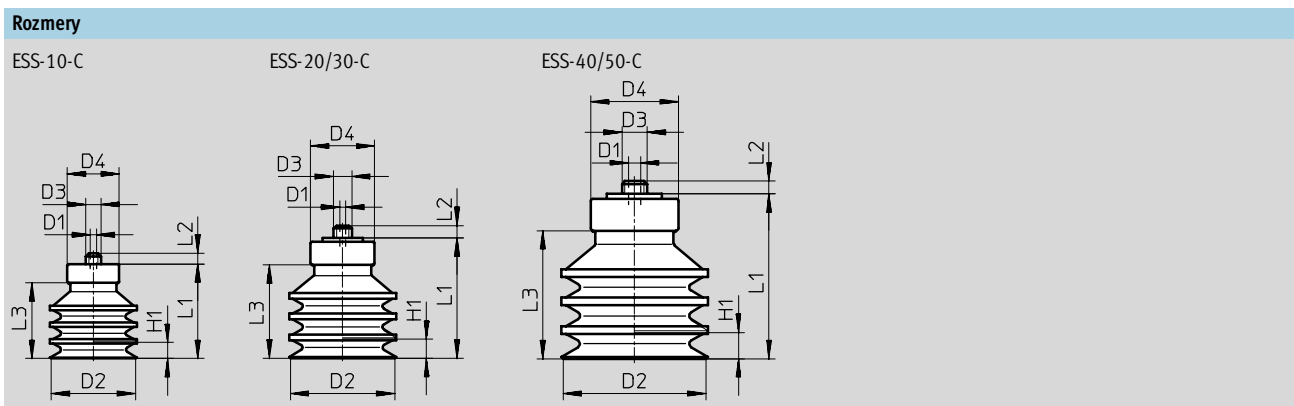

typ prísavek	pre držiak	D1 Ø NW	D2 Ø	D3	D4 Ø	H1	L1	L2	L3
ESS-10-C...	ESG-10-C...	2	10	M4x0,7	10	3,3	12,7	3	8,7
ESS-20-C...	ESG-20-C...	3	20	M6x1	15	7	23	2,4	16,4
ESS-30-C...	ESG-30-C...	3	30	M6x1	18	10,5	34,3	3,4	26,2
ESS-40-C...	ESG-40-C...	3	40	M6x1	25	12,8	39,6	3,2	31
ESS-50-C...	ESG-50-C...	3	50	M6x1	30	17,5	48	3,2	39,4

Typové označenie

prísavka Ø [mm]	ESS		ESV	
	č. dielu	typ	č. dielu	typ
nitrilový kaučuk N				
10	189 398	ESS-10-CN ¹⁾	-	-
20	189 400	ESS-20-CN ¹⁾	191 071	ESV-20-CN
30	189 402	ESS-30-CN ¹⁾	191 073	ESV-30-CN
40	189 404	ESS-40-CN ¹⁾	191 075	ESV-40-CN
50	189 406	ESS-50-CN ¹⁾	191 077	ESV-50-CN
silikón S				
10	189 399	ESS-10-CS	-	-
20	189 401	ESS-20-CS	191 072	ESV-20-CS
30	189 403	ESS-30-CS	191 074	ESV-30-CS
40	189 405	ESS-40-CS	191 076	ESV-40-CS
50	189 407	ESS-50-CS	191 078	ESV-50-CS

1) bez obsahu meďi, silikónu

Prísavka ESS, oválny tvar

technické údaje

FESTO

ESS-...-0...

— | —
teplotný rozsah
-10 ... +70 °C

Funkcia

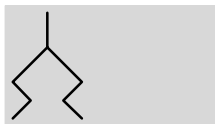

Všeobecné technické údaje						
veľkosť prísavky [mm]	držák prísavky vhodný pre	upevňovací závit	prísavka, účinný Ø [mm]	odtrhávacia sila pri -0,7 bar [N]	objem prísavky ¹⁾ [cm ³]	hmotnosť [g]
4x10	veľkosť 4	M6x1	0,29	2	0,064	2
4x20			0,57	3,4	0,112	2,5
6x10			0,35	2,9	0,106	2
6x20			0,74	5,9	0,196	2,5
8x20			0,89	8	0,256	2,5
8x30			1,36	10,9	0,376	3
10x30			2,23	15,2	0,350	2,9
15x45	veľkosť 5:	M10x1,5	4,84	32	1,570	23,8
20x60			9,12	62,8	3,690	30,8
25x75			14,67	92,5	6,700	46,8
30x90			21,83	134,4	10,170	55,3

1) objem pre odsávanie

Pričná sila F [N] pri pu = -0,7 bar; Ra = 7 µm		
veľkosť prísavky [mm]	horizontálne	vertikálne
4x10	3,5	5
4x20	4,5	11
6x10	8,5	12
6x20	9	12,5
8x20	11	13
8x30	17	13,5
10x30	23	16
15x45	43	35
20x60	116	63
25x75	125,5	115
30x90	201	134,5

Prísavka ESS, oválny tvar

technické údaje

FESTO

Rozmery

ESS-4x10 ... 10x30-0

ESS-15x45 ... 30x90-0

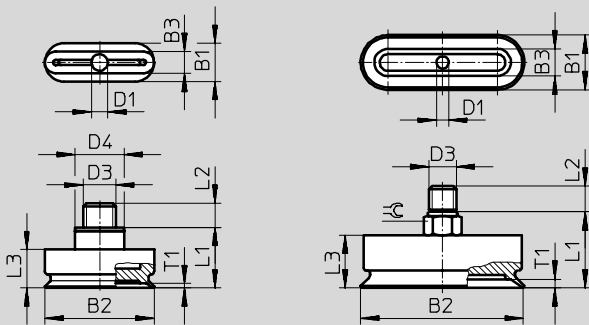

typ	pre prísavky	B1	B2	B3	D1 ∅ NW	D3	D4 ∅	L1	L2	L3	T1	☞
ESS-4x10-0...	ESG-4x10-0...	7	10	4	2,5	M6x1	9	11,1	4,4	7	0,8	-
ESS-4x20-0...	ESG-4x20-0...	7	20	4	2,5	M6x1	9	11,1	4,4	7	0,8	-
ESS-6x10-0...	ESG-6x10-0...	7	10	6	2,5	M6x1	9	11,1	4,4	7	1	-
ESS-6x20-0...	ESG-6x20-0...	7	20	6	2,5	M6x1	9	11,1	4,4	7	1	-
ESS-8x20-0...	ESG-8x20-0...	7	20	8	2,5	M6x1	9	11,1	4,4	7	1	-
ESS-8x30-0...	ESG-8x30-0...	7	30	8	2,5	M6x1	9	11,1	4,4	7	1	-
ESS-10x30-0...	ESG-10x30-0...	10	30	7	2,5	M6x1	9	11,1	4,4	7	1,1	-
ESS-15x45-0...	ESG-15x45-0...	15	45	15	6	M10x1,5	-	25,5	8,5	18,5	2,5	12
ESS-20x60-0...	ESG-20x60-0...	20	60	20	6	M10x1,5	-	26,3	8,5	19,3	3,2	12
ESS-25x75-0...	ESG-25x75-0...	25	75	25	6	M10x1,5	-	28	8,5	21	3,7	12
ESS-30x90-0...	ESG-30x90-0...	30	90	30	6	M10x1,5	-	28,5	8,5	21,5	3,7	12

Typové označenie

veľkosť prísavky [mm]	ESS	
	č. dielu	typ
nitrilový kaučuk N		
4x10	189 408	ESS-4X10-ON ¹⁾
4x20	189 409	ESS-4X20-ON ¹⁾
6x10	189 410	ESS-6X10-ON ¹⁾
6x20	189 411	ESS-6X20-ON ¹⁾
8x20	189 412	ESS-8X20-ON ¹⁾
8x30	189 413	ESS-8X30-ON ¹⁾
10x30	189 414	ESS-10X30-ON ¹⁾
15x45	189 415	ESS-15X45-ON ¹⁾
20x60	189 416	ESS-20X60-ON ¹⁾
25x75	189 417	ESS-25X75-ON ¹⁾
30x90	189 418	ESS-30X90-ON ¹⁾

1) bez obsahu meďi, silikónu

Prísavky

2.1

Prísavky ESS/prísavky ESV, zvonovitý tvar

technické údaje

FESTO

ESS-...-GT-...
ESV-...-GT

-  - teplotný rozsah
-10 ... +80 °C

Funkcia

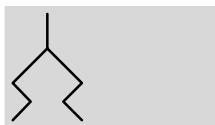

-  - priemer
30 ... 100 mm



Všeobecné technické údaje								
prísavka Ø [mm]	držiak prísavky vhodný pre	upevňovací závit	odtrhávacia sila pri -0,7 bar [N]	min. polomer R ¹⁾ opracovávaného dielu [mm]	objem [cm ³]	hmotnosť		
						ESS [g]	ESV [g]	
30	veľkosť 4	M6x1	36	26	2,3	12	4,2	
	veľkosť 5	M10x1,5				13		
	-	G ¹ / ₈ -I vnútorný závit				14		
	-	G ¹ / ₈ vonkajší závit				13		
40	veľkosť 4	M6x1	64	35	5,1	14	5,7	
	veľkosť 5	M10x1,5				15		
	-	G ¹ / ₄ -I vnútorný závit				5,4		14,5
	-	G ¹ / ₄ vonkajší závit				5,1		16
50	veľkosť 4	M6x1	97	40	11,2	17	9,2	
	veľkosť 5	M10x1,5				18		
	-	G ¹ / ₄ -I vnútorný závit				11,5		18
	-	G ¹ / ₄ vonkajší závit				11,2		21
60	veľkosť 5	M10x1,5	134	75	12,3	20	10,7	
	-	G ¹ / ₄ -I vnútorný závit				19,5		
	-	G ¹ / ₄ vonkajší závit				21		
80	veľkosť 5	M10x1,5	245	100	28,0	28	30,9	
	-	G ¹ / ₄ -I vnútorný závit				61		
	-	G ¹ / ₄ vonkajší závit				60		
100	veľkosť 5	M10x1,5	375	135	53,2	86,5	58,9	
	-	G ¹ / ₄ -I vnútorný závit				89,5		
	-	G ¹ / ₄ vonkajší závit				87,5		

1) minimálny polomer zaoblenia uchopovaného dielu

Prísavky ESS/prísavky ESV, zvonovitý tvar

technické údaje

FESTO

Rozmery

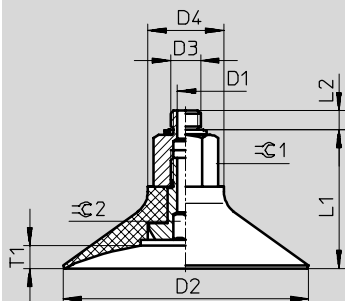

typ	D1 ∅ NW	D2 ∅	D3	D4 ∅	L1	L2	T1	⊘ 1	⊘ 2		
ESS-30-GT	2,5	30	M6	20	27,55	3,45	3,5	15	4		
ESS-30-GT-I			M10		27,8	6,2		17			
			G $\frac{1}{8}$		36,8	4,7		15			
ESS-40-GT	2,5	40	M6	20	29,55	3,45	5,5	15	4		
ESS-40-GT-I			M10		29,8	6,2		17			
			G $\frac{1}{4}$		30,2	5,8		42,2		-	
ESS-50-GT	2,5	50	M6	20	32,05	3,45	8	15	4		
ESS-50-GT-I			M10		32,3	6,2		17			
			G $\frac{1}{4}$		32,7	5,8		44,7		-	
ESS-60-GT	5,5	60	M10	20	34,3	6,2	6	17	4		
ESS-60-GT-I			G $\frac{1}{4}$		34,7	5,8				45,7	-
			G $\frac{1}{4}$		45,7	-					
ESS-80-GT	5,5	80	M10	25	43,3	6,2	7,5	22	8		
ESS-80-GT-I			G $\frac{1}{4}$			5,8					
			G $\frac{1}{4}$			54,7				-	
ESS-100-GT	5,5	100	M10	25	47,8	6,2	9	22	8		
ESS-100-GT-I			G $\frac{1}{4}$			5,8					
			G $\frac{1}{4}$			59,2				-	

Prísavky ESS/prísavky ESV, zvonovitý tvar

technické údaje

FESTO

Typové označenie					
prísavka Ø [mm]	prípoj	ESS		ESV	
		č. dielu	typ	č. dielu	typ
30	M6	525 968	ESS-30-GT-M6 ¹⁾	-	
	M10	525 969	ESS-30-GT-M10 ¹⁾	-	
	G $\frac{1}{8}$ vnútorný závit	525 970	ESS-30-GT-G $\frac{1}{8}$ -I ¹⁾	-	
	G $\frac{1}{8}$	525 971	ESS-30-GT-G $\frac{1}{8}$ ¹⁾	-	
	-	-	-	526 000	ESV-30-GT ¹⁾
40	M6	525 972	ESS-40-GT-M6 ¹⁾	-	
	M10	525 973	ESS-40-GT-M10 ¹⁾	-	
	G $\frac{1}{4}$ vnútorný závit	525 974	ESS-40-GT-G $\frac{1}{4}$ -I ¹⁾	-	
	G $\frac{1}{4}$	525 975	ESS-40-GT-G $\frac{1}{4}$ ¹⁾	-	
	-	-	-	526 001	ESV-40-GT ¹⁾
50	M6	525 976	ESS-50-GT-M6 ¹⁾	-	
	M10	525 977	ESS-50-GT-M10 ¹⁾	-	
	G $\frac{1}{4}$ vnútorný závit	525 978	ESS-50-GT-G $\frac{1}{4}$ -I ¹⁾	-	
	G $\frac{1}{4}$	525 979	ESS-50-GT-G $\frac{1}{4}$ ¹⁾	-	
	-	-	-	526 002	ESV-50-GT ¹⁾
60	M10	525 980	ESS-60-GT-M10 ¹⁾	-	
	G $\frac{1}{4}$ vnútorný závit	525 981	ESS-60-GT-G $\frac{1}{4}$ -I ¹⁾	-	
	G $\frac{1}{4}$	525 982	ESS-60-GT-G $\frac{1}{4}$ ¹⁾	-	
	-	-	-	526 003	ESV-60-GT ¹⁾
80	M10	525 983	ESS-80-GT-M10 ¹⁾	-	
	G $\frac{1}{4}$ vnútorný závit	525 984	ESS-80-GT-G $\frac{1}{4}$ -I ¹⁾	-	
	G $\frac{1}{4}$	525 985	ESS-80-GT-G $\frac{1}{4}$ ¹⁾	-	
	-	-	-	526 004	ESV-80-GT ¹⁾
100	M10	525 986	ESS-100-GT-M10 ¹⁾	-	
	G $\frac{1}{4}$ vnútorný závit	525 987	ESS-100-GT-G $\frac{1}{4}$ -I ¹⁾	-	
	G $\frac{1}{4}$	525 988	ESS-100-GT-G $\frac{1}{4}$ ¹⁾	-	
	-	-	-	526 005	ESV-100-GT ¹⁾

1) bez obsahu meďi, silikónu