

Single-axis systems

FESTO

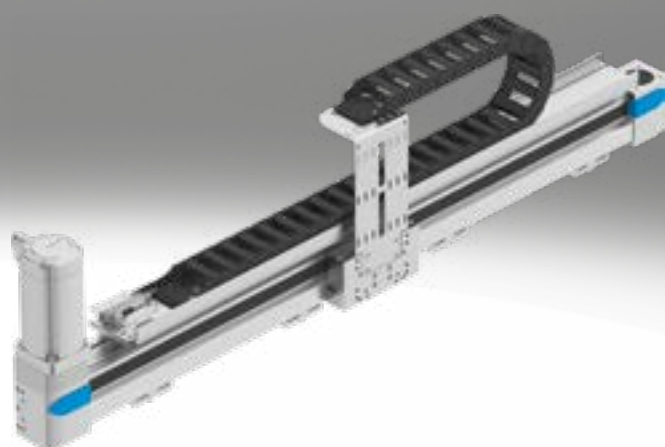

Key features

At a glance

A single-axis system (YXCS) is an axis module (EHM...) for any single-axis movement.

- Ideal for long gantry strokes and heavy loads
- High mechanical rigidity and sturdy design
- Use of tried-and-tested drives/axes from Festo

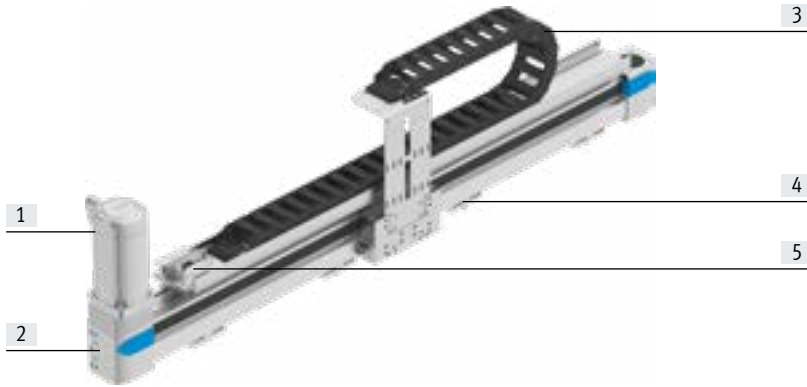

- [1] Servo motor for the Y-module
- [2] Y-axis
- [3] Energy chain for the Y-module
- [4] Profile mounting/adjusting kit
- [5] Electrical signals (such as for end-position sensing) are transferred collectively via the multi-pin plug distributor

Description of the modules

Single-axis system

Design:

The Y-module EHY comprises a linear axis which is powered by a servo motor. The following components are located on the motor side:

- Energy chain
- Multi-pin plug distributor for proximity switch (if a sensor package has been selected)

Sample image:

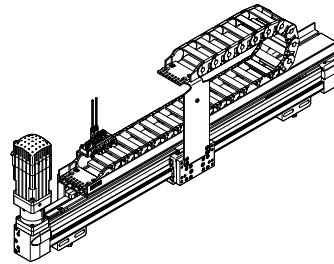

Dispatch options

Fully assembled:

The single-axis system is fully assembled. All cables are installed and connected.

System overview¹⁾

Size	YXCS
Max. working stroke	3000 mm
Max. payload	Dependent on the selected dynamic response
Mounting position	Horizontal

¹⁾ Drive package depends on the configuration selected.

Characteristics

Configurator: Handling Guide Online (HGO)

Selecting a handling system

Planning complex handling systems takes a lot of time. You can use the configurator "Handling Guide Online" (HGO) to design a customised handling system for your application in just a few steps.

You can choose from the following systems:

- Single-axis system
- 2D linear gantry
- 2D planar surface gantry
- 3D gantry
- 3D cantilever system

Advantages:

- Automatic selection of all relevant components
- Automatic design and calculation of the workload
- Quote created automatically
- CAD model available immediately
- Configuration-specific parameters for servo drives available immediately
- Complete Eplan project can be ordered according to the individual configuration
- Fully automated processing
- You can order fully or partially assembled systems through the Online Shop
- Lots of possible options

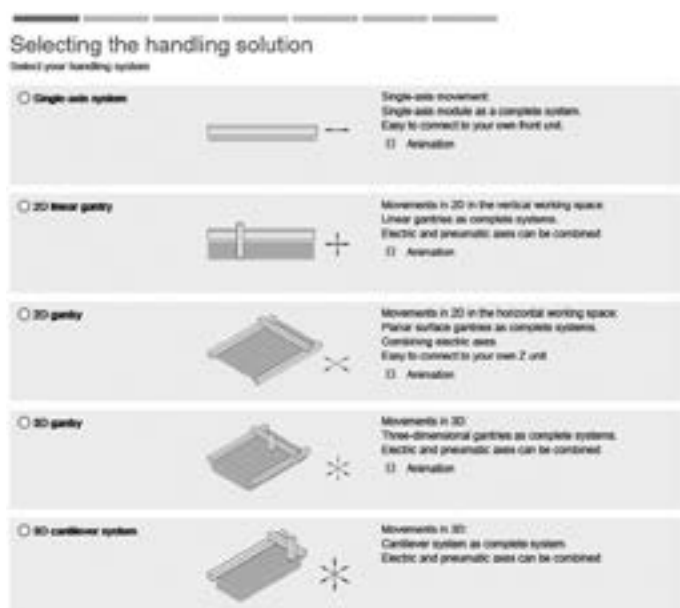

Entering the application data

- Payload
- Drive system of the axis
- Distance from the centre of the load
- Working stroke
- Reference cycle

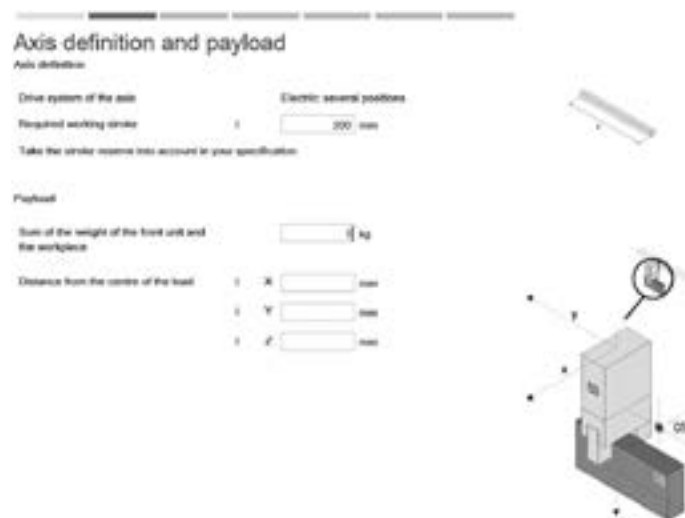

Characteristics

Result of calculation

You will be offered a selection of systems calculated based on the application data you entered.

The following are available immediately:

- CAD model
- Datasheet of the selected system
- Price information

Result of calculation
Select the appropriate system and continue with the configuration:

No.	System series	System workload i	Repetition accuracy (m)	Your price
<input checked="" type="checkbox"/>	1	YKCB	57 %	0.08 mm
<input type="checkbox"/>	2	YKCB	52 %	0.08 mm
<input type="checkbox"/>	3	YKCB	21 %	0.08 mm
<input type="checkbox"/>	7	YKCB	49 %	0.08 mm
<input type="checkbox"/>	8	YKCB	8 %	0.08 mm

Single-axis system YKCB 81

Drive module	Tapped ball axis CUC-50
Kinematics type	Serial kinematics
Stroke	200 mm
Repetition accuracy (m)	0.08 mm
Clearance	Without
Type of motor	Stepper motor CMMS-01
Motor position	Left
Motor controller	CMMS-01
Electrical voltage phases	DC voltage

Data protection Back Continue

System overview

You will be given an overview of the complete system.

You will also have the following options:

- Show price
- Send request
- Add to basket

Your handling solution
Your selected system overview

Exemplary representation



System CUC-50-200mm

Your system 81
C1371013

Your next steps:

- Show price
- Send request
- Add to basket

Features	Value
Handling type	Single-axis system
Payload	1 kg
Drive system of the axis	Electric motor position
Working stroke	200 mm
Motor position on the axis	Left

Characteristics

Standard components within the handling system

The handling system comprises a number of tried-and-tested standard components from Festo. Different components are used depending on the configuration. The single axes installed will be displayed in the configurator HGO on the "Result of calculation" page.

Drives/axes

Y-axis

Toothed belt axis EGC-TB-KF



- Electric
- Rigid, closed profile
- Recirculating ball bearing guide for high loads and torques
- High dynamic response and minimum vibration

Toothed belt axis EGC-HD-TB



- Electric
- Flat drive unit with rigid, closed profile
- Duo guide rail
- For maximum loads and torques, high feed forces and speeds and long service life

Possible axis combinations¹⁾

YXCS	<ul style="list-style-type: none"> • Toothed belt axis EGC-50-TB-KF • Toothed belt axis EGC-80-TB-KF • Toothed belt axis EGC-120-TB-KF • Toothed belt axis EGC-185-TB-KF • Toothed belt axis with heavy-duty guide EGC-HD-125-TB • Toothed belt axis with heavy-duty guide EGC-HD-160-TB • Toothed belt axis with heavy-duty guide EGC-HD-220-TB
------	---

1) Drive package depends on the configuration selected.

Characteristics

Standard components within the handling system

The handling system comprises a number of tried-and-tested standard components from Festo. Different components are used depending on the configuration. You can alter the scope and design of the drive package in the configurator HGO on the "System configuration" page.

Motors and controllers

Servo motors EMMT-AS



- Dynamic, brushless, permanently excited servo motor
- Digital absolute displacement encoder in single-turn or multi-turn version
- With optional brake

Stepper motors EMMS-ST



- Two-phase hybrid technology
- Step angle 1.8°
- With optional brake

Gear unit EMGA



- Low-backlash planetary gear
- Gear ratio
i = 3 and 5
- Life-time lubrication

Servo drive CMMT-AS, for servo motor



- Universal servo drive
- For synchronous servo motors
- Integrated EMC filters
- Integrated brake chopper
- Integrated braking resistor
- Position controller
- Speed controller
- Force controller
- Range of control functions

Options:

- Safety function: safe torque off (STO)/category 4, Performance Level e
- Safe stop 1 (SS1)
- Safe brake control (SBC) up to SIL3/ category 3, Performance Level e

- Bus protocols
 - EtherCAT
 - PROFINET RT/IRT
 - EtherNet/IP
 - Modbus TCP

Servo drive CMMT-ST, for stepper motor



- Servo drive for operating stepper motors and brushless direct current motors
- Options for point-to-point and interpolating motion and for precise positioning
- Primary voltage from 24 ... 48 V DC
- Position controller
- Speed controller
- Force controller
- Range of control functions

Options:

- Safety function: safe torque off (STO)/category 3, Performance Level e
- Safe stop 1 time controlled (SS1-t)

- Bus protocols
 - EtherCAT
 - PROFINET RT/IRT
 - EtherNet/IP
 - Modbus TCP

Ordering data – Accessories

Module/motor combinations

We recommend that the single-axis system is operated with the proposed motors from Festo. These precisely match the mechanical system. When using third-party motors, it is essential that the technical limits are observed.

Module	Motor Servo motor	Stepper motor
Y-module		
EHMY-...-EGC-50-TB-KF	–	EMMS-ST-57-M-...
EHMY-...-EGC-80-TB-KF	EMMT-AS-60-S-LS-...	EMMS-ST-57-S-...
EHMY-...-EGC-120-TB-KF	EMMT-AS-80-L-LS-...	EMMS-ST-87-S-...
	EMMT-AS-80-L-HS-...	–
EHMY-...-EGC-125-TB-HD	EMMT-AS-60-L-LS-...	EMMS-ST-57-S-...
EHMY-...-EGC-160-TB-HD	EMMT-AS-80-M-LS-...	EMMS-ST-87-S-...
	EMMT-AS-80-L-HS-...	–
EHMY-...-EGC-185-TB-KF	EMMT-AS-100-L-HS-...	–
	EMMT-AS-100-H-HS-...	–
	EMMT-AS-150-M-HV-R3...	–
EHMY-...-EGC-220-TB-HD	EMMT-AS-100-L-HS-...	–
	EMMT-AS-100-H-HS-...	–
	EMMT-AS-150-M-HV-R3...	–

Ordering data

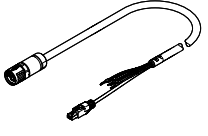
Ordering data	Description	Cable length [m]	Part no.	Type
For servo motor EMMT-AS				
Motor cable				
	• For EMMT-AS-60/80-...-R2... with CMMT-AS	2.5	5251374	NEBM-M23G15-EH-2.5-Q7N-R3LEG14
		5	5251375	NEBM-M23G15-EH-5-Q7N-R3LEG14
		7.5	5251376	NEBM-M23G15-EH-7.5-Q7N-R3LEG14
		10	5251377	NEBM-M23G15-EH-10-Q7N-R3LEG14
		15	5251378	NEBM-M23G15-EH-15-Q7N-R3LEG14
		20	5251379	NEBM-M23G15-EH-20-Q7N-R3LEG14
	• For EMMT-AS-100-...-R2... with CMMT-AS	2.5	5251381	NEBM-M23G15-EH-2.5-Q9N-R3LEG14
		5	5251382	NEBM-M23G15-EH-5-Q9N-R3LEG14
		7.5	5251383	NEBM-M23G15-EH-7.5-Q9N-R3LEG14
		10	5251384	NEBM-M23G15-EH-10-Q9N-R3LEG14
		15	5251385	NEBM-M23G15-EH-15-Q9N-R3LEG14
		20	5251386	NEBM-M23G15-EH-20-Q9N-R3LEG14
	• For EMMT-AS-150-...-R3... with CMMT-AS	2.5	5251395	NEBM-M40G15-EH-2.5-Q11N-R3LEG14
		5	5251396	NEBM-M40G15-EH-5-Q11N-R3LEG14
		7.5	5251397	NEBM-M40G15-EH-7.5-Q11N-R3LEG14
		10	5251398	NEBM-M40G15-EH-10-Q11N-R3LEG14
		15	5251399	NEBM-M40G15-EH-15-Q11N-R3LEG14
		20	5251400	NEBM-M40G15-EH-20-Q11N-R3LEG14

Ordering data – Accessories

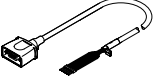
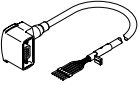
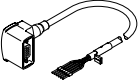
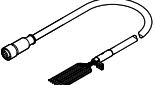
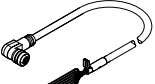
Designation	Description	Cable length [m]	Part no.	Type
For stepper motor EMMS-ST				
Motor cable¹⁾				
	<ul style="list-style-type: none"> For stepper motor EMMS-ST-57 with CMMT-ST Straight plug 	2.5	1450369	NEBM-S1G9-E-2.5-Q5-LE6
		5	1450370	NEBM-S1G9-E-5-Q5-LE6
		7	1450371	NEBM-S1G9-E-7-Q5-LE6
		10	1450372	NEBM-S1G9-E-10-Q5-LE6
		15	5085055	NEBM-S1G9-E-15-Q5-LE6
		20	5085056	NEBM-S1G9-E-20-Q5-LE6
	<ul style="list-style-type: none"> For stepper motor EMMS-ST-57 with CMMT-ST Angled plug 	2.5	1450737	NEBM-S1W9-E-2.5-Q5-LE6
		5	1450738	NEBM-S1W9-E-5-Q5-LE6
		7	1450739	NEBM-S1W9-E-7-Q5-LE6
		10	1450740	NEBM-S1W9-E-10-Q5-LE6
		15	610856	NEBM-S1W9-E-15-Q5-LE6
	<ul style="list-style-type: none"> For stepper motor EMMS-ST-87 with CMMT-ST Angled plug 	2.5	1450944	NEBM-S1W15-E-2.5-Q7-LE6
		5.0	1450945	NEBM-S1W15-E-5-Q7-LE6
		7.0	1450946	NEBM-S1W15-E-7-Q7-LE6
		10	1450947	NEBM-S1W15-E-10-Q7-LE6
		15	610857	NEBM-S1W15-E-15-Q7-LE6
Encoder cable¹⁾				
	<ul style="list-style-type: none"> For stepper motor EMMS-ST-57/87 with CMMT-ST Straight plug 	2.5	1451587	NEBM-M12G8-E-2.5-LE8
		5	1451588	NEBM-M12G8-E-5-LE8
		7	1451589	NEBM-M12G8-E-7-LE8
		10	1451590	NEBM-M12G8-E-10-LE8
		15	611110	NEBM-M12G8-E-15-LE8
		20	611111	NEBM-M12G8-E-20-LE8
	<ul style="list-style-type: none"> For stepper motor EMMS-ST-57/87 with CMMT-ST Angled plug 	2.5	1451675	NEBM-M12W8-E-2.5-LE8
		5	1451676	NEBM-M12W8-E-5-LE8
		7	1451677	NEBM-M12W8-E-7-LE8
		10	1451678	NEBM-M12W8-E-10-LE8
		15	610858	NEBM-M12W8-E-15-LE8

1) Cables especially suitable for the motor controller and motor.
Degree of protection to IP65 (in assembled state)

Possible cable lengths

- Cables are selected so that the length specified when ordering will be the minimum connection length from the energy chain output.
- Cables are only available in fixed lengths as stated in the table below. This can mean that the cable plugs of the different cables do not end at the same point.

Length	2 m	5 m	7 m	10 m
Motor cable	■	■	■	■
Encoder cable	■	■	■	■
Multi-pin plug connecting cable	■	■	■	■

Ordering data – Accessories

Standard components within the handling system

The handling system comprises a number of tried-and-tested standard components from Festo. Different components are used depending on the configuration. You can alter the scope and design of the accessories in the configurator HGO on the "System configuration" page.

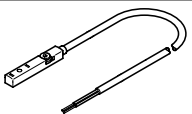
Designation	Description	Cable length	Part no.	Type	
Proximity switch (inductive) for sensing the position of the slide					
	Cable with open end				
	• For toothed belt axis EGC-TB, EGC-HD-TB	PNP, N/C contact	7.5 m	551391	SIES-8M-PO-24V-K-7.5-OE
	• For DC voltage	PNP, N/O contact	7.5 m	551386	SIES-8M-PS-24V-K-7.5-OE
	• Flush mounting	NPN, N/C contact	7.5 m	551401	SIES-8M-NO-24V-K-7.5-OE
	Included if the "Festo sensor package" is selected: • 2 pieces	NPN, N/O contact	7.5 m	551396	SIES-8M-NS-24V-K-7.5-OE

Designation	Description	Cable length	Part no.	Type
Plug socket with cable				
	• Connection between multi-pin plug distributor and control cabinet	5 m	525618	SIM-M12-8GD-5-PU
		10 m	570008	SIM-M12-8GD-10-PU

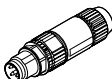
Designation	Description	Cable length	Part no.	Type
Plug				
	• For connection to the multi-pin plug distributor	–	562024	NECU-S-M8G3-HX

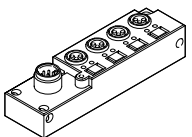
Designation	Description	Cable length	Part no.	Type
Multi-pin plug distributor				
	• With the help of the multi-pin plug distributor, electrical signals such as for end-position sensing can be transferred collectively Options: – 4 individual connections – 6 individual connections	–	574586	NEDU-L4R1-M8G3L-M12G8
			574587	NEDU-L6R1-M8G3L-M12G8

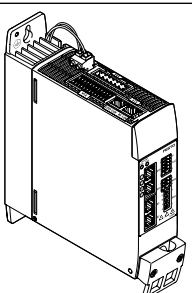
Designation	Description
Motor controller/servo drive	
	The accessories for the relevant motor controllers/servo drives can be found at: • www.festo.com/catalogue/cmmt

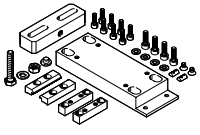
Designation	Description	Part no.	Type	
Adjusting kit				
	• Used to mount the handling system on a vertical surface • Once mounted, the axis can be aligned horizontally	EHMY-...-EGC-50-TB-KF	8047576	EADC-E16-50-E7
		EHMY-...-EGC-80-TB-KF	8047577	EADC-E16-80-E7
		EHMY-...-EGC-120-TB-KF	8047578	EADC-E16-120-E7
		EHMY-...-EGC-185-TB-KF	8047579	EADC-E16-185-E7
		EHMY-...-EGC-125-TB-HD	8047580	EADC-E16-125-E14
		EHMY-...-EGC-160-TB-HD	8047581	EADC-E16-160-E14
EHMY-...-EGC-220-TB-HD	8047582	EADC-E16-220-E14		

Programming aid

Festo Automation Suite

Parameterisation and programming software for electronic devices from Festo

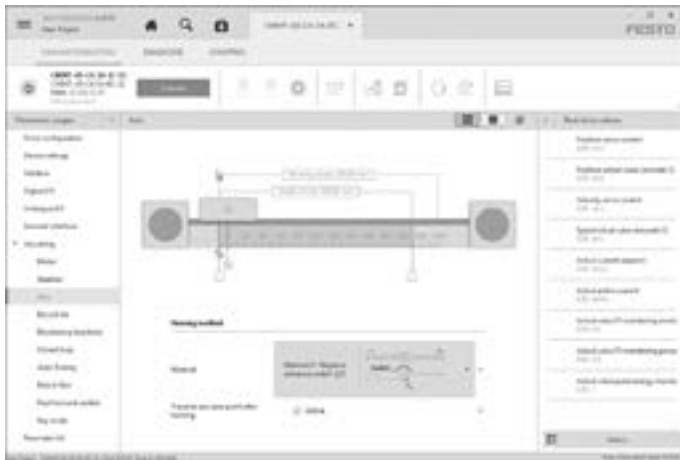

- Parameterisation, programming and commissioning in a clear and user-friendly interface
- Optimum support for complex processes thanks to guided wizards (e.g. for commissioning, drive configuration, etc.)
- Fast access to the required documents and additional information
- Easy integration of electric drives in the controller programming