

## Solenoid valves VUVG/valve manifold assembly VTUG-S

**FESTO**

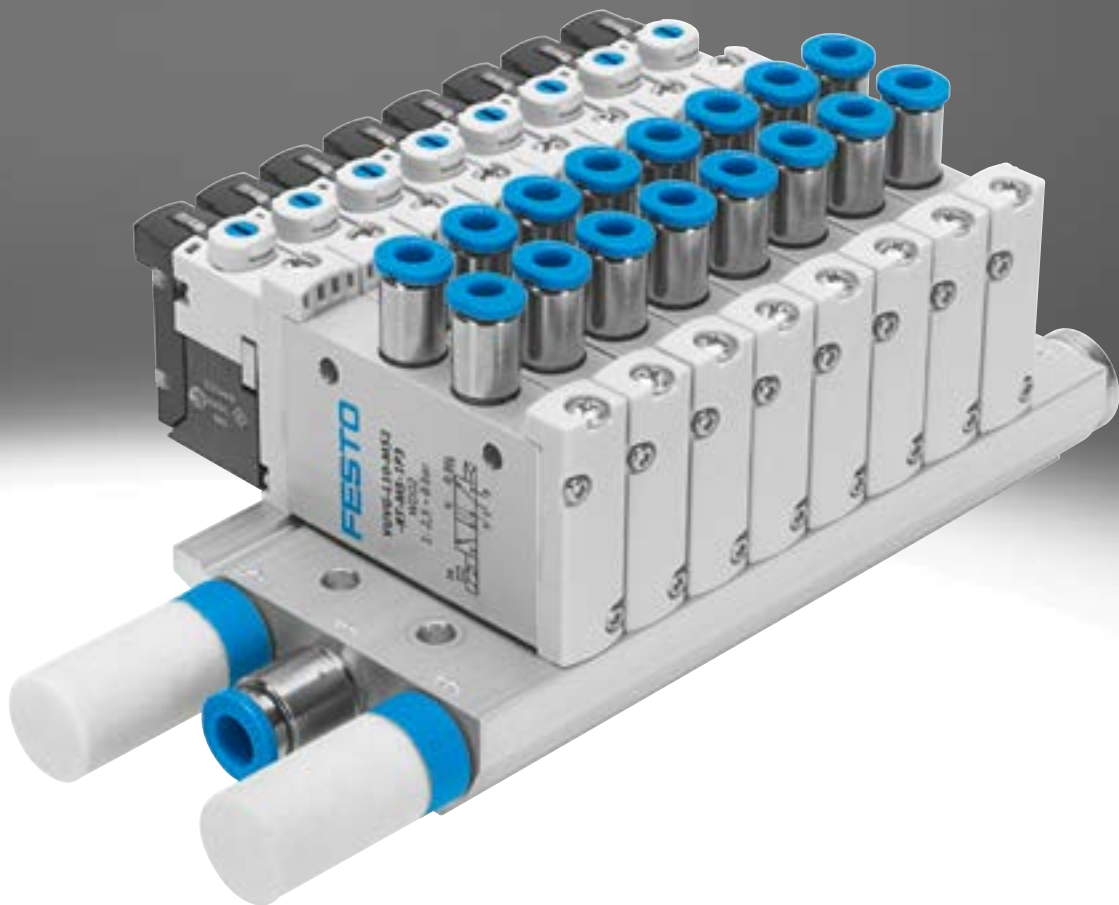

Festo Core Range  
Solves the majority of your automation tasks

Worldwide:  
Simply good:  
Fast:

Quickest delivery – wherever, whenever  
Expected high Festo quality  
Easy and fast to select

With the Festo Core Range, we have selected the most important products and functions from our broad product catalogue, and added the quickest delivery.

The Core Range offers you the best value for your automation tasks.

Just look  
for the  
star!

## Key features

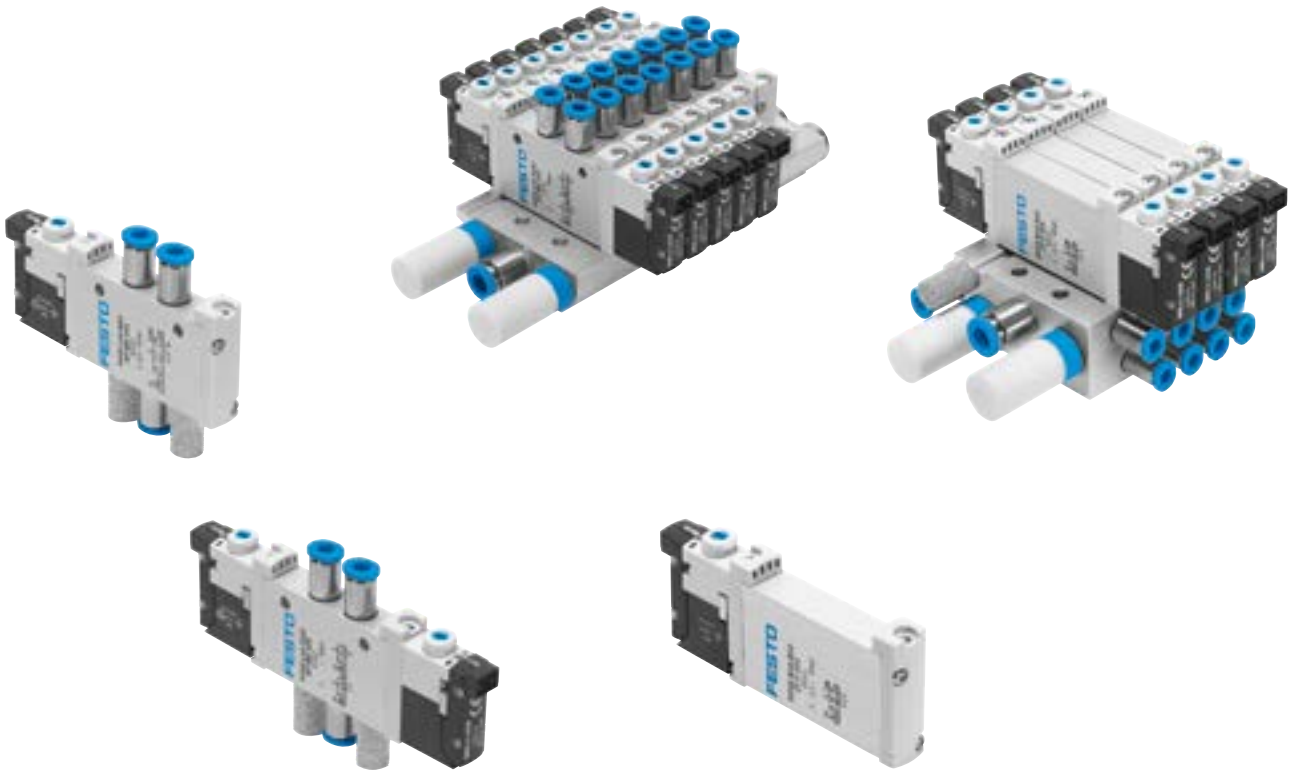

### Innovative

- Can be set to internal or external pilot air supply for manifold assemblies with sub-base valves
- Maximum pressure 10 bar
- Design principle:
  - Piston spool with sealing ring (VUVG-LK, VUVG-BK)
  - Piston spool with sealing cartridge (VUVG-L, VUVG-B)

### Flexible

- Wide range of valve functions
- Choice of quick push-in connectors
- In-line valves
- Semi in-line valves for manifold assembly
- M5 and M7 in-line valves can be combined on one manifold rail
- Valve manifold assembly with pressure zones
- IP40, IP65
- Connection technology via:
  - Electrical connection block (E-box)
  - Pneumatic interface CNOMO, to ISO 15218

### Reliable

- Sturdy and durable metal components
  - Valves
  - Manifold rails
- Fast troubleshooting thanks to 360° LED display
- Convenient servicing thanks to valves that can be replaced quickly and easily
- Choice of manual override: non-detenting, covered, non-detenting/detenting or detenting (without accessories)

### Easy to install

- Secure wall mounting or H-rail mounting
- Easy mounting, captive screws and seal
- Connection technology easy to change via the electrical sub-base
- Identification holder for labelling the valves

### Ordering data – Product options

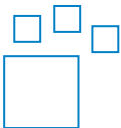

Configurable product  
This product and all its product options can be ordered using the configurator.

The configurator can be found at  
→ [www.festo.com/catalogue/...](http://www.festo.com/catalogue/...)  
Enter the part number or the type.

Part no.	Type
564212	VUVG
575203	VUVG-...T1
8163285	VUVG-...F1A

## Key features – Pneumatic components

### Individual valves and valve manifold assemblies

#### In-line valves as individual valve

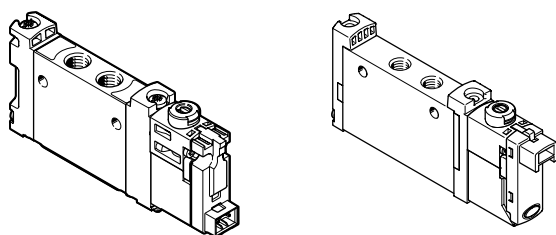

In-line valves are designed to be used without being linked pneumatically. All pneumatic connections are on the valve and can be equipped with fittings/tubing. The electrical connection is established via different E-boxes.

If a special seal set is used, in-line valves VUVG can also be mounted on a manifold rail (pneumatic linking) as semi in-line valves.

#### In-line valve VUVG-LK/VUVG-L

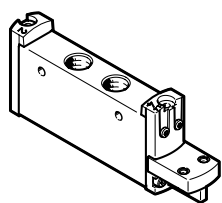

The in-line valve VTUG-L...-P1 to ISO15218 is a solenoid valve without electrical pilot control.

The basic valve with the CNOMO pneumatic interface to ISO15218 can be equipped with the following electrical pilot controls:

- Connection type C (DIN EN175301-803)
- Connection type C to industry standard
- Connection M12 (IEC61076-2-101)

#### In-line valve VUVG-L, to ISO15218 (CNOMO)

### Semi in-line valves for manifold assembly

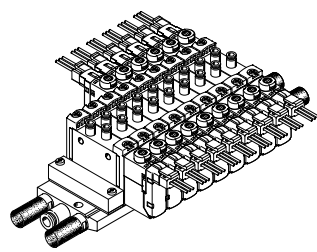
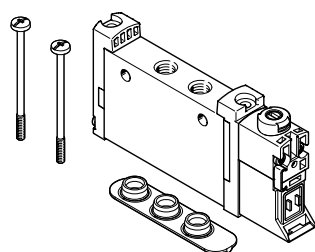

The supply ports (1, 3 and 5) for semi in-line valves are connected to the valve by common pneumatic links (e.g. sub-base).

The working ports (2, 4) are on the valve. The electrical connection is established via different E-boxes.

#### Semi in-line valve VUVG-S

Valve manifold assembly VTUG comprised of semi in-line valves VUVG-S

### Sub-base valves for manifold assembly

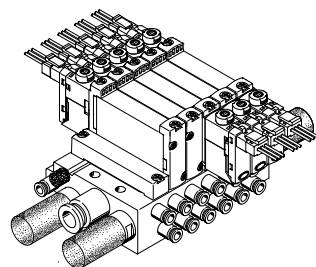
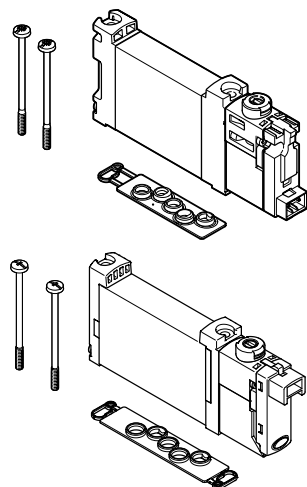

The supply ports (1, 3 and 5) and the working ports (2, 4) of sub-base valves are connected to the valve by a pneumatic link (e.g. sub-base)

. The electrical connection is established via different E-boxes.

#### Sub-base valve VUVG-BK/VUVG-B

Valve manifold assembly VTUG comprised of sub-base valves VUVG-BK/VUVG-B

## Key features – Pneumatic components

### Basic valves VUVG

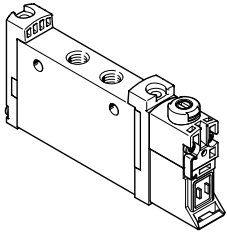

- Size 10, 14 and 18 mm
- In-line valves and semi in-line valves
- Sub-base valves
- 2x 3/2-way, 5/2-way and 5/3-way valves

### E-boxes

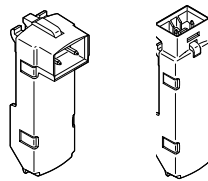

- 5, 12 and 24 V DC
- With or without holding current reduction
- LED

### Combinations of basic valve and E-boxes

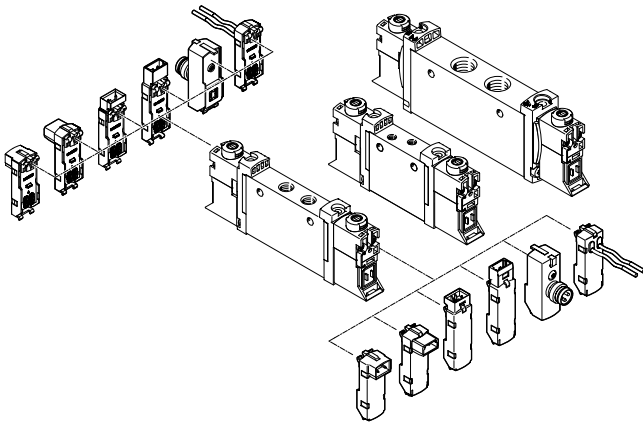

 **Note**  
More E-boxes → page 112

### Cover caps for manual override

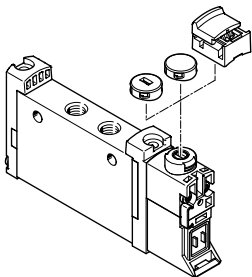

- Closed cover cap, concealed manual override
- Slotted cover cap, non-detenting manual override
- Cover, detenting manual override

### Identification holder

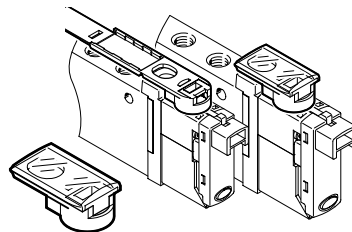

- The identification holder is mounted in the same way as a cover cap for manual override
- The hinged identification holder covers the retaining screw and the manual override

## Key features – Pneumatic components

## Manifold rail for in-line valves

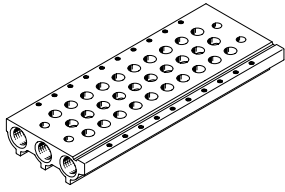

- For in-line valves M3, M5, M7, G1/8 and G1/4
- For 2x 3/2-way, 5/2-way and 5/3-way valves
- 2 to 10 and 12, 14, 16 valve positions

## Manifold rail for sub-base valves

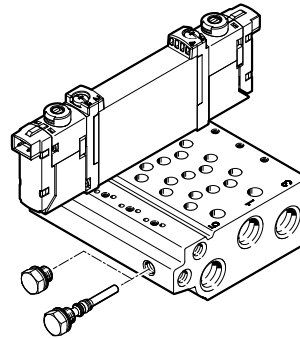

- For sub-base valves 10A, 10, 14 and 18
- Manifold rail with M5, M7, G1/8 and G1/4 working ports
- For 2x 3/2-way, 5/2-way and 5/3-way valves
- 2 to 10, 12, 14 and 16 valve positions
- The sub-base valves are always supplied with external pilot air. The pilot air is set via the manifold rail. A short and a long blanking plug are therefore included in the scope of delivery of the manifold rail.

 **Note**

Pressurisation and exhaust at both ends is recommended for an optimised flow rate in cases where multiple valves switch simultaneously.

## Cover plate for vacant position

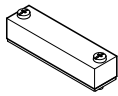

Vacant position cover

## Supply plate

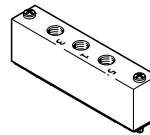

For additional air supply and exhaust via a valve position

## Separator for pressure zones



For creating multiple pressure zones in a valve manifold assembly

## Key features – Pneumatic components

### Vertical pressure supply plate

For in-line valves M5/M7 and G1/8

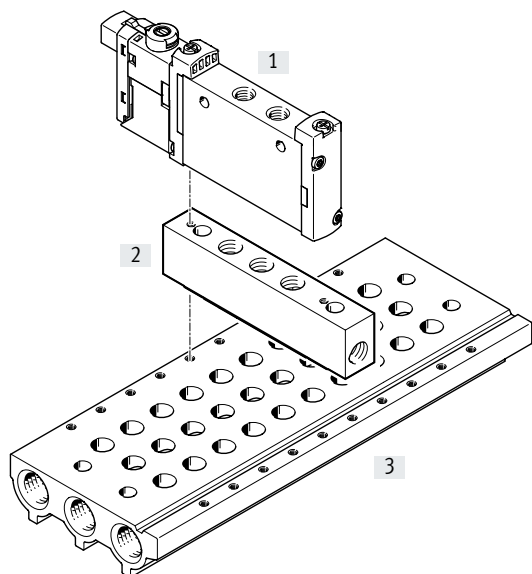

- [1] In-line valves VUVG
- [2] Vertical pressure supply plate
- [3] Manifold rail

The vertical pressure supply plate allows the valve mounted on it to be pressurised and exhausted separately. If two vertical pressure supply plates are mounted on top of each other, the valve can be supplied with compressed air and exhausted completely independently of the valve terminal (terminal code CS).

Code	Diagram	Type	For in-line valves		Description
			M5/M7	G1/8	
ZU		VABF-L1-P3A	■	■	Plate with port 1 for supplying an individual operating pressure or separate exhausting (reverse operation) for a valve position.
ZV		VABF-L1-P7A	■	■	Plate with ports 3 and 5 for exhausting the valve or supplying an individual operating pressure (reverse operation) for a valve position.

## Key features – Pneumatic components

## Exhaust functions

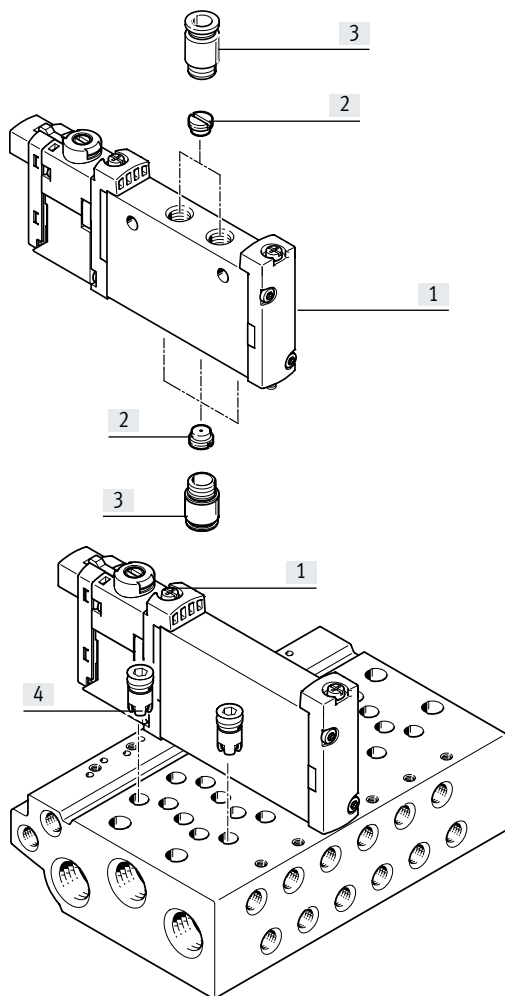

- [1] Valves VUVG with individual electrical connection
- [2] Flow restrictor for M5 thread
- [3] Fitting
- [4] Fixed flow restrictor, self-tapping/check valve

## Flow restrictor for M5 thread

In-line valve, individual electrical connection: flow restrictor can be fitted in port 1, 3, 5 and/or in port 2, 4.

Sub-base valve, individual electrical connection: flow restrictor can be fitted in port 2, 4.

## Fixed flow restrictor, self-tapping

The fixed flow restrictor can be used to permanently set the exhaust flow rate in ducts 3 and 5.

The fixed flow restrictors are screwed into ducts 3 and 5 in the manifold rail.

Please see the relevant assembly instructions:

→ [www.festo.com/sp](http://www.festo.com/sp)

## Check valve

Check valves block the flow towards the valves if back pressure develops in ducts 3 and 5 in the case of a high exhaust output, thereby preventing actuators from switching unexpectedly. The check valves are screwed into ducts 3 and 5 in the manifold rail. Please see the relevant assembly instructions:

→ [www.festo.com/sp](http://www.festo.com/sp)

- Note**
- It is not possible to use a check valve and a fixed flow restrictor (in the same duct) at the same time.
  - When screwing in again, use the threads already present.

## Key features – Pneumatic components

### Creating pressure zones and separating exhaust air

Compressed air is supplied and exhausted via the manifold rail and via supply plates.  
The position of the supply plates and duct separations can be freely selected with the VUVG.

Pressure zones are created by isolating the internal supply ducts between the manifold sub-bases by appropriate duct separation.

Pressure zone separation can be used for the following ducts:

- Duct 1
- Duct 3
- Duct 5



**Note**

- Use a separator if the exhaust air pressures are high
- Use at least one supply plate/air supply for each pressure zone
- Pressure zone separation is not possible in duct 12/14 (pilot air supply)

### Duct separation

#### Description

Pressure zones can be freely configured with the VUVG. The following duct separations are possible:

Duct 1 closed

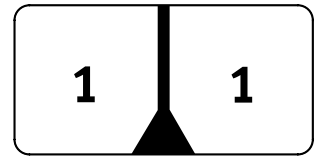

Duct 1, 3, 5 closed

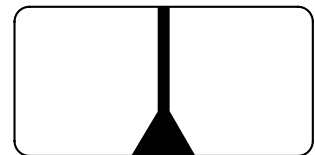

Duct 3, 5 closed

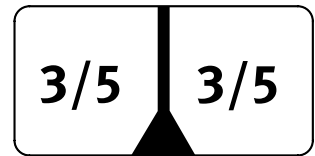

With the VUVG, the number of pressure zones is limited only by the number of valve positions on the manifold rail. Note that each supply plate occupies one valve position.

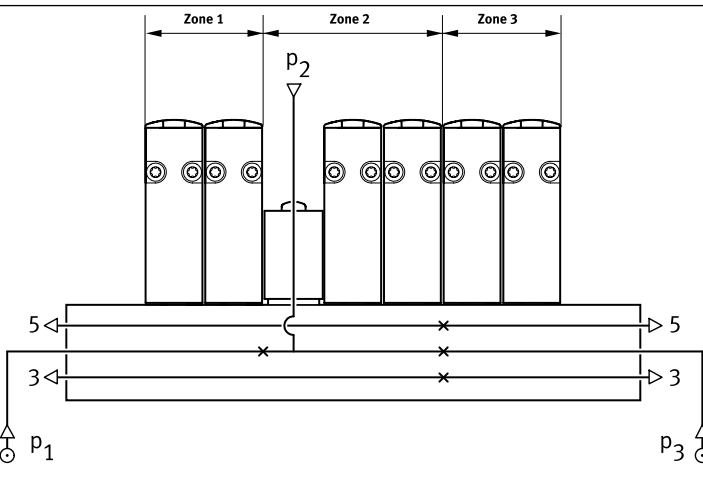
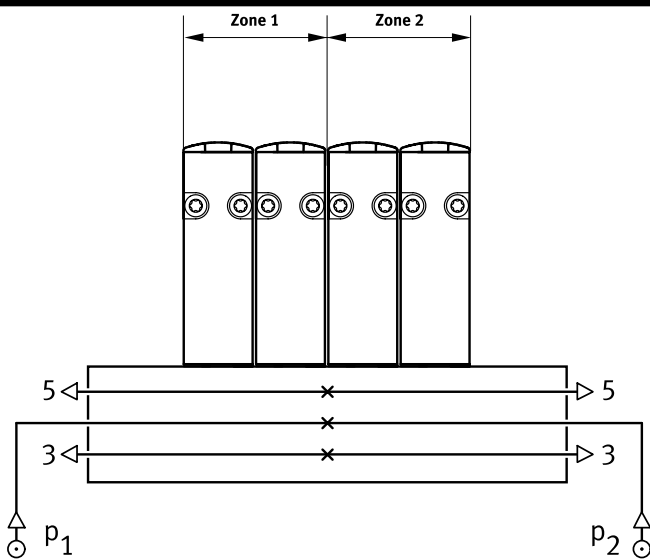

### Separator VABD

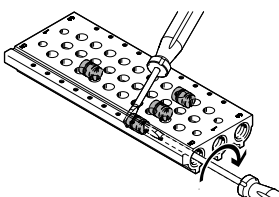

**Note**

As the separators are only fitted from one side using a slotted screwdriver, several pressure zones can be created in one profile.



## Key features – Pneumatic components

### Pilot air supply

#### Internal pilot air supply

Internal pilot air supply can be chosen with an operating pressure between 0.15 ... 0.8 MPa, 0.25 ... 0.8 MPa, or 0.3 ... 0.8 MPa (depending on the valve used).

The pilot air supply is branched from duct 1 (compressed air supply) using an internal connection.

#### External pilot air supply

External pilot air supply is required for vacuum operation. The port for external pilot air supply (port 12/14) is located on the valve in the case of in-line valves and on the manifold rail in the case of sub-base valves.

#### Pilot exhaust air

With in-line valves, the pilot exhaust air escapes via exhaust holes. With sub-base valves, the pilot air is exhausted via duct 82/84 of the manifold rail.

### Pilot air supply with in-line and semi in-line valves

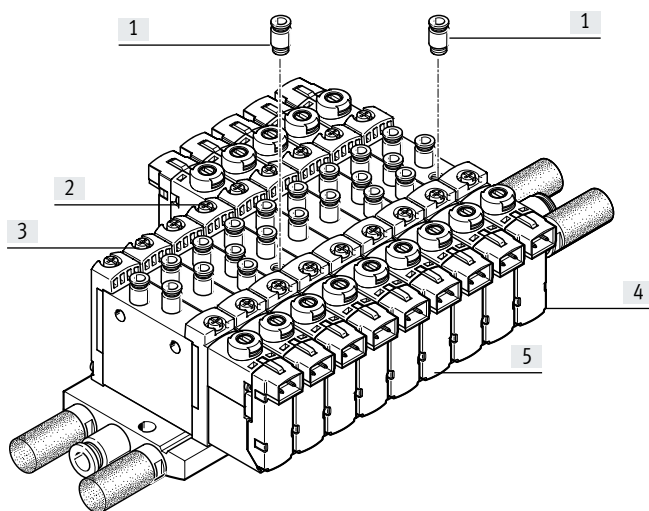

- [1] Push-in fitting for external pilot air supply at port 12/14
- [2] Single solenoid valve with external pilot air supply
- [3] Single solenoid valve with internal pilot air supply
- [4] Double solenoid valve with external pilot air supply
- [5] Double solenoid valve with internal pilot air supply

The internal pilot air is branched from port 1 in the valve body. The external pilot air (port 12/14) is supplied individually at each valve housing.

#### Note

Semi in-line valves cannot be supplied centrally with pilot air via the manifold rail.

### Pilot air supply with sub-base valves

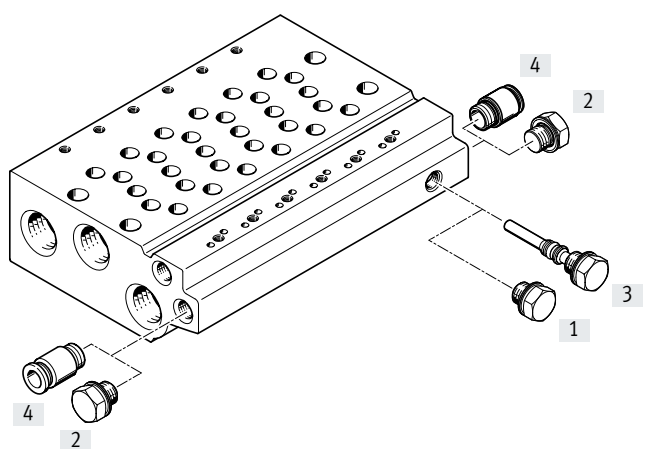

- [1] Blanking plug, short, with internal pilot air
- [2] Blanking plug for duct 12/14 with internal pilot air
- [3] Blanking plug, long, with external pilot air
- [4] Push-in fitting in duct 12/14 with external pilot air

The manifold rails for sub-base valves have an internal connection between duct 12/14 and duct 1. By inserting a blanking plug into this connection, it is possible to switch between internal and external pilot air.

## Key features – Pneumatic components

### Operation with different pressures

#### Vacuum operation

#### Points to note with 3/2-way valves

The 3/2-way valves are available in a design with two valves in one valve body and with pneumatic spring return. With these valves, the force for the return movement is obtained from port 1.

Vacuum operation is therefore only possible at port 3 and 5, not at port 1.

With external pilot air supply, vacuum can be connected at port 1, 3, 5 of the 5/2-way and 5/3-way valves.

#### Reverse operation

The 3/2-way valves with pneumatic spring are not suitable for reverse operation, since at least the minimum pilot pressure must be available at duct 1.

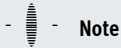

#### Note

Pressure must be available at port 1.

#### Pressure divider (internal pilot air)

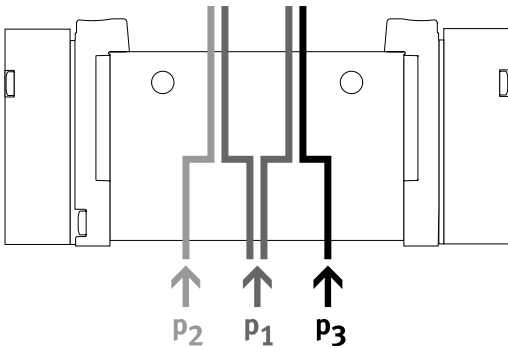

- If two different pressures are required.

- Different pressures can be supplied at duct 1, 3 and 5.



#### Note

- With internal pilot air supply, the minimum pilot pressure must be adhered to in duct 1
- With 2x 3/2-way valves without spring return, the minimum pilot pressure must always be adhered to in duct 1

#### Advantages

Any pressure or vacuum can be connected at ducts 3 and 5 both with external and internal pilot air.

#### Vacuum, ejector pulse and normal position

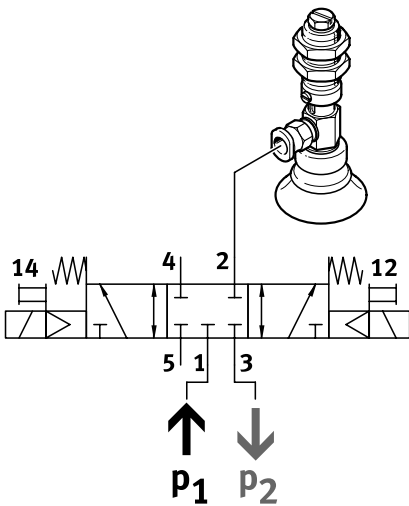

Vacuum, ejector pulse and normal position can be achieved as follows:

- Internal pilot air supply
- Vacuum in duct 3
- Pressure for the ejector pulse in duct 1

## Key features – Mounting

### Mounting – Individual valve VUVG

#### Cylinder mounting

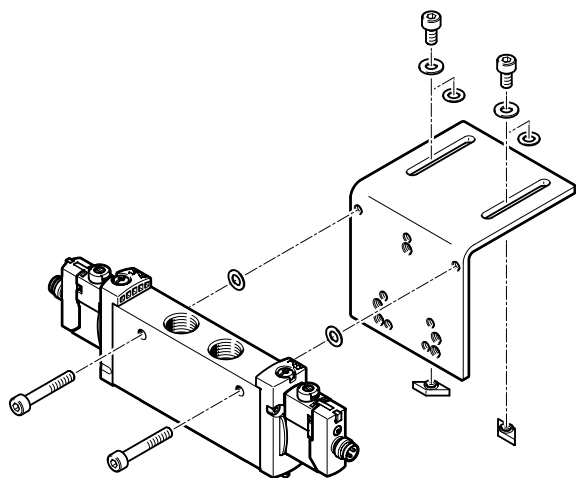

For mounting individual valves directly on a drive.

The solenoid valves are provided with two through-holes for attaching to the cylinder mounting DAVM-MW-V1...-V. Mounting is only possible on the side on which the pneumatic connections are located.

The relevant screw set is included when the cylinder mounting DAVM-MW-V1...-V is ordered.

Product range overview

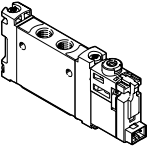
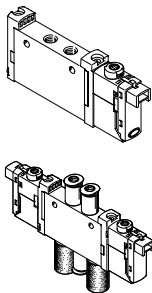
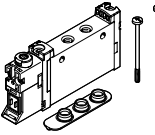
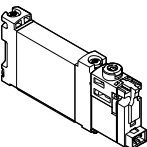
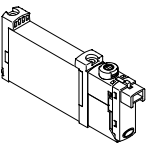
Design	Working port	Size	Functions and flow rate [l/min]												→ Page/ Internet		
			T32C	T32U	T32H	T32C/M	T32U/M	T32H/M	M52	M52/M	B52	P53C	P53U	P53E			
<b>In-line valve as individual valve, solenoid valve VUVG-LK</b>																	
	M5	10	■ 180	-	-	-	-	-	-	■ 195	-	■ 195	-	-	-	30	
	M7	10	■ 280	-	-	-	-	-	-	■ 340	-	■ 340	-	-	-		34
	G1/8	14	■ 570	-	-	-	-	-	-	■ 660	-	■ 660	-	-	-		
<b>In-line valve as individual valve, solenoid valve VUVG-L</b>																	
	M3	10A	-	-	-	-	-	-	-	■ 100	■ 80	■ 100	■ 90	■ 90	■ 90	24	
	M5	10	■ 150	■ 150	■ 150	■ 135	■ 125	■ 125	■ 220	■ 190	■ 220	■ 210	■ 210	■ 210	38		
	M7	10	■ 190	■ 190	■ 190	■ 150	■ 140	■ 140	■ 330	■ 220	■ 380	■ 320	■ 320	■ 320			44
	G1/8	14	■ 560	■ 600	■ 590	■ 550	■ 500	■ 500	■ 780	■ 780	■ 780	■ 650	■ 560	■ 560	57		
	G1/4	18	■ 880	■ 970	■ 950	■ 870	■ 990	■ 920	■ 1300	■ 1300	■ 1380	■ 1200	■ 1000	■ 910			68
<b>Semi in-line valve for manifold assembly, solenoid valve VUVG-S</b>																	
	M5	10	■ 150	■ 150	■ 150	■ 135	■ 125	■ 125	■ 220	■ 190	■ 220	■ 210	■ 210	■ 210	38		
	M7	10	■ 190	■ 190	■ 190	■ 150	■ 140	■ 140	■ 330	■ 220	■ 380	■ 320	■ 320	■ 320		44	
	G1/8	14	■ 560	■ 600	■ 590	■ 550	■ 500	■ 500	■ 780	■ 780	■ 780	■ 650	■ 560	■ 560			57
	G1/4	18	■ 880	■ 970	■ 950	■ 870	■ 990	■ 920	■ 1300	■ 1300	■ 1380	■ 1200	■ 1000	■ 910		68	
<b>Sub-base valve, solenoid valve VUVG-BK</b>																	
	M5	10	■ 160	-	-	-	-	-	-	■ 160	-	■ 160	-	-	-	83	
	M7	10	■ 160	-	-	-	-	-	-	■ 160	-	■ 160	-	-	-		83
	G1/8	14	■ 350	-	-	-	-	-	-	■ 380	-	■ 380	-	-	-		
<b>Sub-base valve, solenoid valve VUVG-B</b>																	
	M3	10A	-	-	-	-	-	-	-	■ 100	■ 80	■ 100	■ 90	■ 90	■ 90	78	
	M5	10	■ 150	■ 150	■ 150	■ 130	■ 120	■ 120	■ 210	■ 180	■ 210	■ 200	■ 200	■ 200	86		
	M7	10	■ 160	■ 160	■ 160	■ 140	■ 130	■ 130	■ 270	■ 230	■ 270	■ 250	■ 250	■ 250			86
	G1/8	14	■ 510	■ 510	■ 510	■ 430	■ 410	■ 410	■ 520	■ 570	■ 570	■ 520	■ 500	■ 460	92		
	G1/4	18	■ 800	■ 800	■ 800	■ 800	■ 800	■ 800	■ 1000	■ 1000	■ 1000	■ 950	■ 950	■ 950			102

## Product range overview

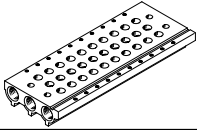
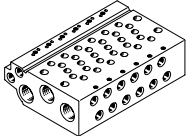
Design	Size	Description	→ Page/ Internet
<b>Manifold rail VABM- ... -S- ... for in-line valves (manifold assembly)</b>			
	10AS	Size M3	29, 51, 66, 76
	10S	Size M5, M7	
	14S	Size G1/8	
	18S	Size G1/4	
<b>Manifold rail VABM, for sub-base valves (manifold assembly)</b>			
	10AW	Size M3	82, 91, 101, 108
	10W	Size M5	
	10HW	Size M7	
	14W	Size G1/8	
	18W	Size G1/4	

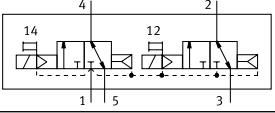
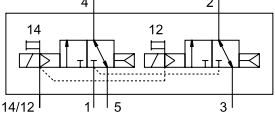
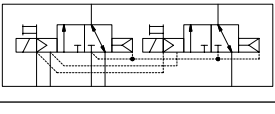
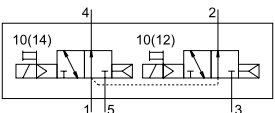
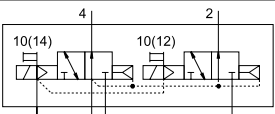
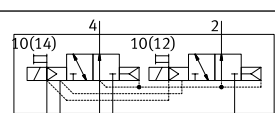
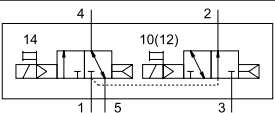
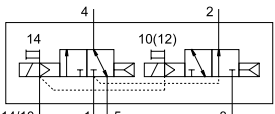
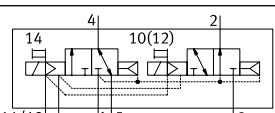

Overview of valve functions

Valve	Valve code	Description	VUVG-LK, VUVG-BK		VUVG-L, VUVG-B			
			Size		Size			
			M5/M7	G1/8	M3	M5/M7	G1/8	G1/4
<b>2x 3/2-way valve, normally closed, pneumatic spring</b>								
	T32C-A	In-line valve, pilot air supply Internal	■	■	-	■	■	■
		In-line valve, pilot air supply External	-	-	-	■	■	-
		Sub-base valve, external pilot air supply	-	-	-	■	■	■
<b>2x 3/2-way valve, normally open, pneumatic spring</b>								
	T32U-A	In-line valve, pilot air supply Internal	-	-	-	■	■	■
		In-line valve, pilot air supply External	-	-	-	■	■	-
		Sub-base valve, external pilot air supply	-	-	-	■	■	■
<b>2x 3/2-way valve, 1x normally open, 1x normally closed, pneumatic spring</b>								
	T32H-A	In-line valve, pilot air supply Internal	-	-	-	■	■	■
		In-line valve, pilot air supply External	-	-	-	■	■	-
		Sub-base valve, external pilot air supply	-	-	-	■	■	■

### Overview of valve functions

Valve	Valve code	Description	VUVG-LK, VUVG-BK		VUVG-L, VUVG-B			
			Size		Size			
			M5/M7	G1/8	M3	M5/M7	G1/8	G1/4
<b>2x 3/2-way valve, normally closed, mechanical spring</b>								
	T32C-M	In-line valve, pilot air supply Internal	-	-	-	■	■	■
		In-line valve, pilot air supply External	-	-	-	■	■	■
		Sub-base valve, external pilot air supply	-	-	-	■	■	■
<b>2x 3/2-way valve, normally open, mechanical spring</b>								
	T32U-M	In-line valve, pilot air supply Internal	-	-	-	■	■	■
		In-line valve, pilot air supply External	-	-	-	■	■	■
		Sub-base valve, external pilot air supply	-	-	-	■	■	■
<b>2x 3/2-way valve, 1x normally open, 1x normally closed, mechanical spring</b>								
	T32H-M	In-line valve, pilot air supply Internal	-	-	-	■	■	■
		In-line valve, pilot air supply External	-	-	-	■	■	■
		Sub-base valve, external pilot air supply	-	-	-	■	■	■

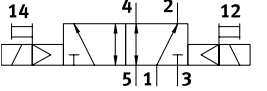
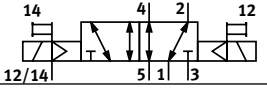
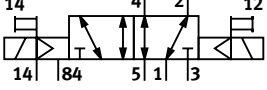
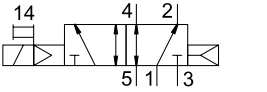
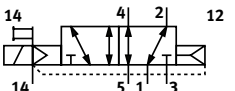
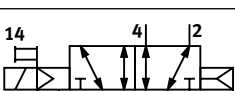
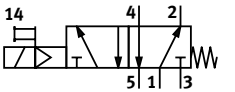
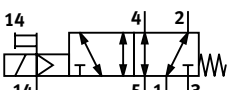
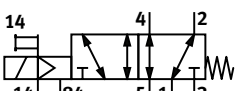
Overview of valve functions

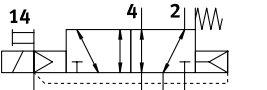
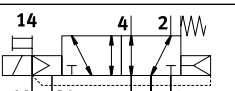
Valve	Valve code	Description	VUVG-LK, VUVG-BK		VUVG-L, VUVG-B			
			Size		Size			
			M5/M7	G1/8	M3	M5/M7	G1/8	G1/4
<b>5/2-way valve, double solenoid</b>								
	B52	In-line valve, pilot air supply Internal	■	■	■	■	■	■
		In-line valve, pilot air supply External	-	-	■	■	■	■
		Sub-base valve, external pilot air supply	-	-	■	■	■	■
<b>5/2-way valve, single solenoid, pneumatic spring</b>								
	M52-A	In-line valve, pilot air supply Internal	■	■	-	-	■	-
		In-line valve, pilot air supply External	-	-	-	-	■	-
		Sub-base valve, external pilot air supply	-	-	-	-	■	-
<b>5/2-way single solenoid valve, mechanical spring</b>								
	M52-M	In-line valve, pilot air supply Internal	-	-	■	■	■	■
		In-line valve, pilot air supply External	-	-	■	■	■	■
		Sub-base valve, external pilot air supply	-	-	■	■	■	■
<b>5/2-way valve, single solenoid, pneumatic/mechanical spring</b>								
	M52-R	In-line valve, pilot air supply Internal	-	-	■	■	-	■
		In-line valve, pilot air supply External	-	-	■	■	-	■
		Sub-base valve, external pilot air supply	-	-	■	■	-	■

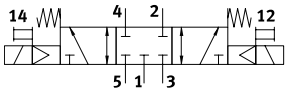
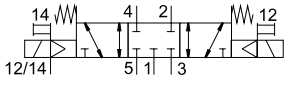
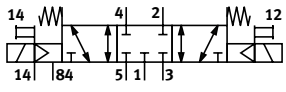
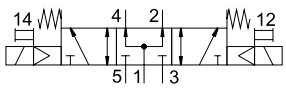
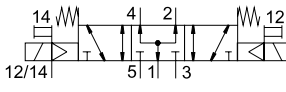
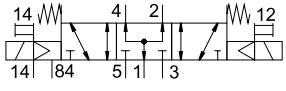
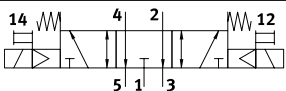
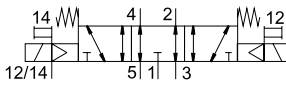
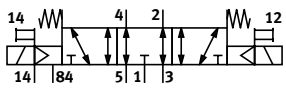

### Overview of valve functions

Valve	Valve code	Description	VUVG-LK, VUVG-BK		VUVG-L, VUVG-B			
			Size		Size			
			M5/M7	G1/8	M3	M5/M7	G1/8	G1/4
<b>5/3-way valve, mid-position closed</b>								
	P53C	In-line valve, pilot air supply Internal	-	-	■	■	■	■
		In-line valve, pilot air supply External	-	-	■	■	■	■
		Sub-base valve, external pilot air supply	-	-	■	■	■	■
<b>5/3-way valve, mid-position pressurised</b>								
	P53U	In-line valve, pilot air supply Internal	-	-	■	■	■	■
		In-line valve, pilot air supply External	-	-	■	■	■	■
		Sub-base valve, external pilot air supply	-	-	■	■	■	■
<b>5/3-way valve, mid-position exhausted</b>								
	P53E	In-line valve, pilot air supply Internal	-	-	■	■	■	■
		In-line valve, pilot air supply External	-	-	■	■	■	■
		Sub-base valve, external pilot air supply	-	-	■	■	■	■

Peripherals overview example – In-line valves

Manifold assembly

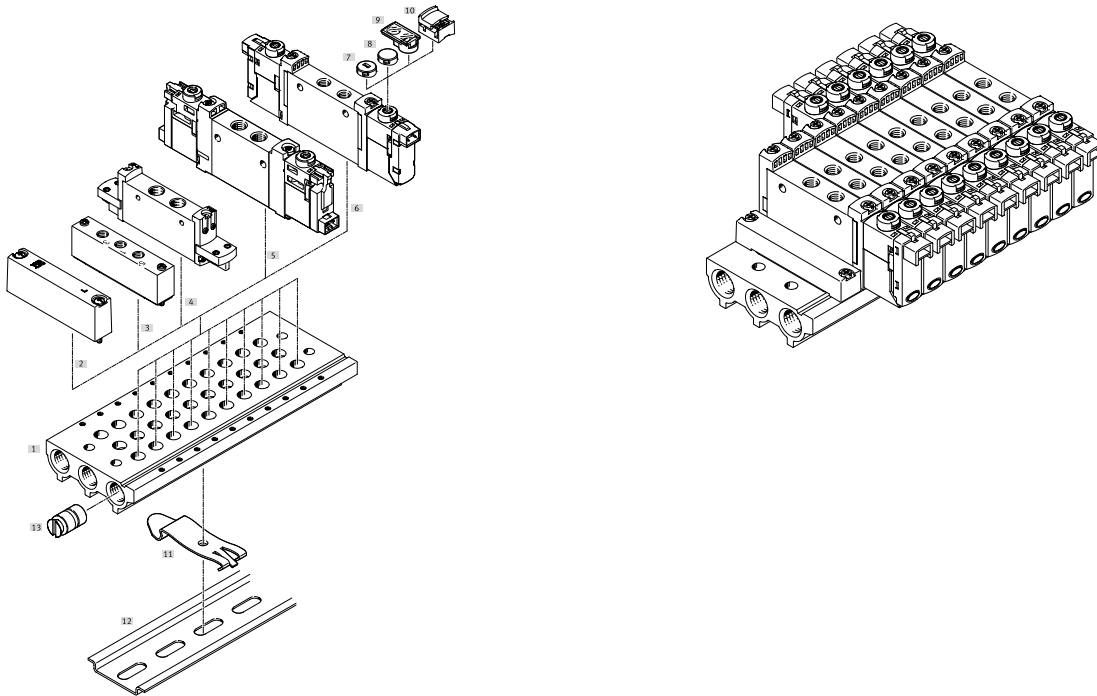

Manifold assembly and accessories				
	Type	Description	→ Page/Internet	
[1]	Manifold rail	VABM-L1-...	For 2 to 10, 12, 14 and 16 valve positions	90
[2]	Cover plate	VABB-L1-...	For covering a vacant position	29
[3]	Supply plate	VABF-L1-...	For air supply at duct 1 and duct 3 and 5	29
[4]	Solenoid valve	VUVG-....P1	In-line valve 2x 3/2-way, 5/2-way and 5/3-way	64
[5]	Solenoid valve	VUVG-LK...	In-line valve 2x 3/2-way, 5/2-way and 5/3-way	30
[6]	Solenoid valve	VUVG-L...	In-line valve 2x 3/2-way, 5/2-way and 5/3-way	30
[7]	Cover cap (non-detenting)	VMPA-HB...-B	For manual override	117
[8]	Cover cap (concealed)	VMPA-HB...-B	For manual override	117
[9]	Identification holder	ASLR-D	For labelling the valves, covering the retaining screw and the manual override	117
[10]	Cover cap (detenting)	VAMC-L1-...	For manual override	117
[11]	H-rail mounting	VAME-T-M4	2 pieces for fitting the valve manifold assembly on an H-rail	117
[12]	H-rail	NRH-35-2000	For mounting the valve manifold assembly	117
[13]	Separator	VABD-...	For creating pressure zones	29

## Peripherals overview example – In-line valves

### Manifold assembly

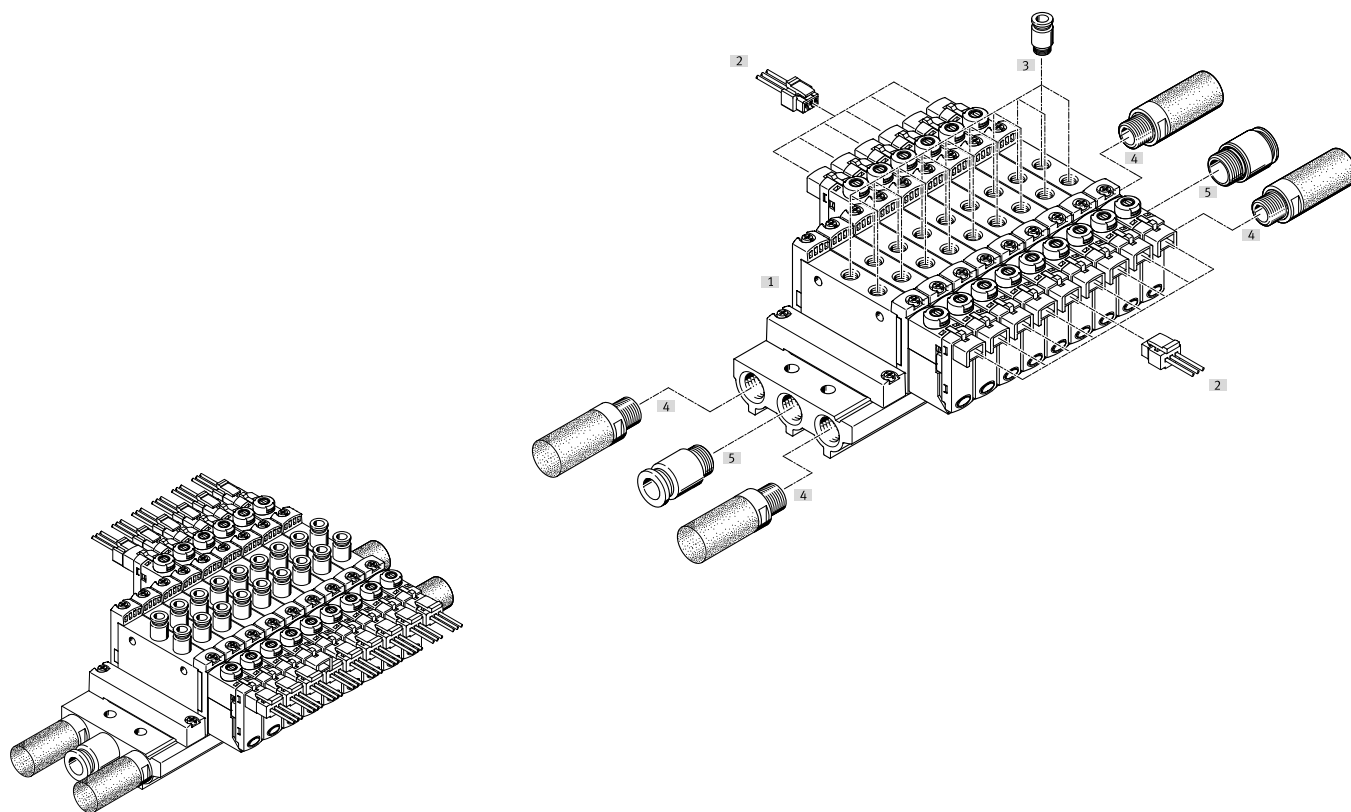

#### Manifold assembly and accessories

	Type	Description	→ Page/Internet
[1] Manifold rail	VABM-L1-...	For 2 to 10, 12, 14 and 16 valve positions	90
[2] Plug socket with cable	NEBV-H1G2-...-LE2	For E-box H2 and H3	115
[3] Push-in fitting	QS...	Push-in fitting for duct 2 and 4	116
[4] Silencers	U...	For duct 3 and 5	117
[5] Push-in fitting	QS...	Push-in fitting for air supply at duct 1	116

Peripherals overview example – Sub-base valves

**Manifold assembly**

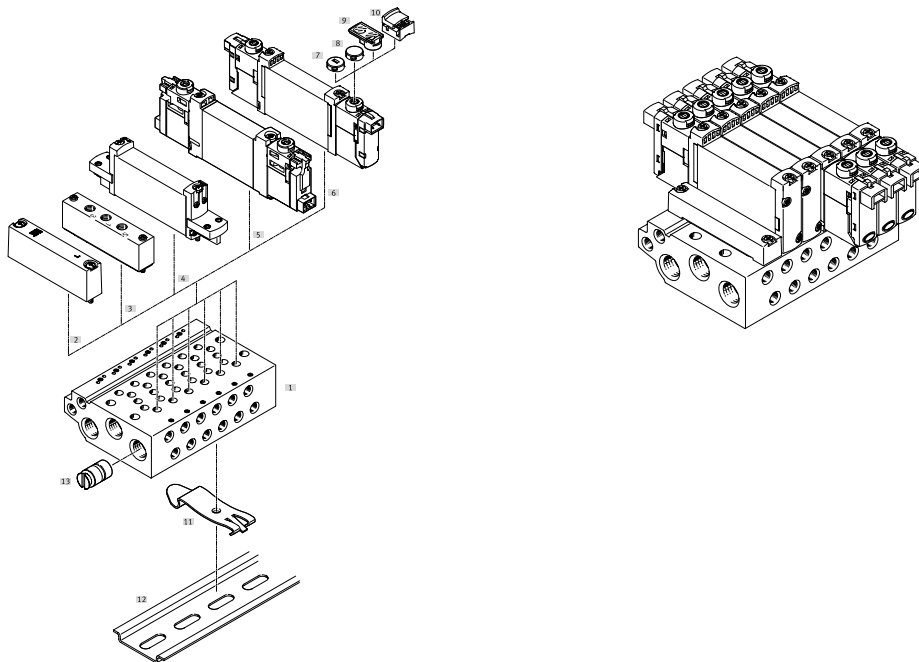

Manifold assembly and accessories				
	Type	Description	→ Page/Internet	
[1]	Manifold rail	VABM-L1-...	For 2 to 10, 12, 14 and 16 valve positions	90
[2]	Cover plate	VABB-L1-...	For covering a vacant position	91
[3]	Supply plate	VABF-L1-...	For air supply at duct 1 and duct 3 and 5	91
[4]	Solenoid valve	VUVG-...-P1	In-line valve 2x 3/2-way, 5/2-way and 5/3-way	99
[5]	Solenoid valve	VUVG-BK...	Sub-base valve 2x 3/2-way, 5/2-way and 5/3-way	83
[6]	Solenoid valve	VUVG-B...	Sub-base valve 2x 3/2-way, 5/2-way and 5/3-way	83
[7]	Cover cap (non-detenting)	VMPA-HB...-B	For manual override	117
[8]	Cover cap (concealed)	VMPA-HB...-B	For manual override	117
[9]	Identification holder	ASLR-D	For labelling the valves, covering the retaining screw and the manual override	117
[10]	Cover cap (detenting)	VAMC-L1-...	For manual override	117
[11]	H-rail mounting	VAME-T-M4	2 pieces for fitting the valve manifold assembly on an H-rail	117
[12]	H-rail	NRH-35-2000	For mounting the valve manifold assembly	117
[13]	Separator	VABD- ...	For creating pressure zones	91

## Peripherals overview example – Sub-base valves

## Manifold assembly

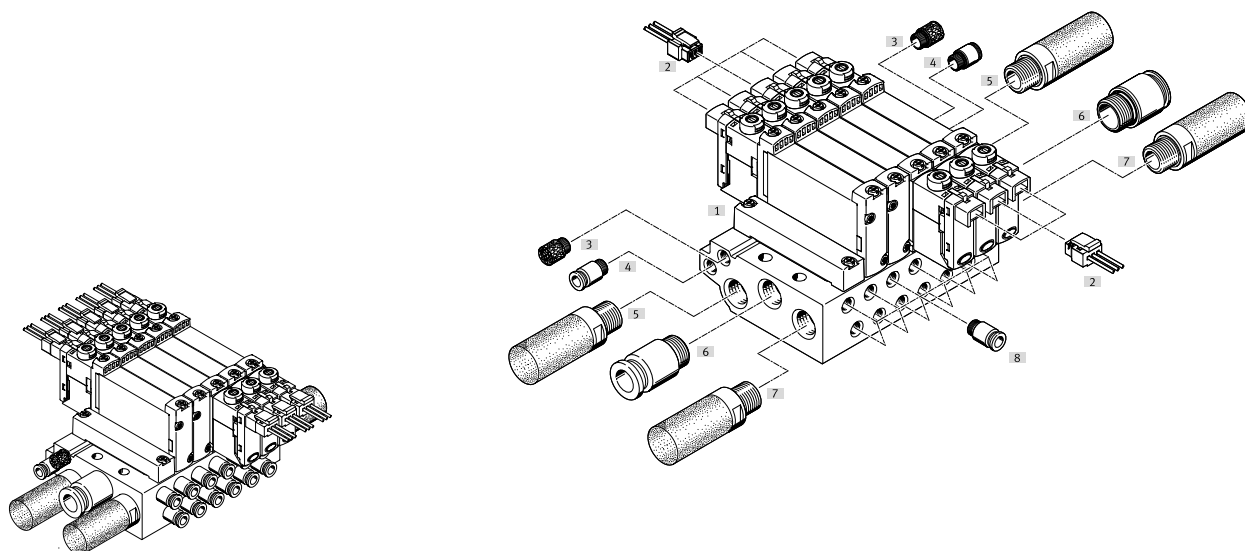

## Manifold assembly and accessories

	Type	Description	→ Page/Internet	
[1]	Manifold rail	VABM-L1-...	For 2 to 10, 12, 14 and 16 valve positions	90
[2]	Plug socket with cable	NEBV-H1G2-KN-...-LE2	For E-box H2 and H3	115
[3]	Silencers	U...	Silencer for pilot air exhaust at duct 82/84	117
[4]	Push-in fitting	QS...	Push-in fitting for pilot air supply at duct 12/14	116
[5]	Silencers	U...	For duct 3 and 5	117
[6]	Push-in fitting	QS...	Push-in fitting for air supply at duct 1	116
[7]	Silencers	U...	For duct 3 and 5	117
[8]	Push-in fitting	QS...	Push-in fitting for duct 2 and 4	116

## Type codes

001	Series
VUVG	Solenoid valve

002	Directional control valve type
L	In-line valve
S	Semi-inline valve
B	Sub-base valve

003	Design principle
	Piston spool
K	Piston spool with sealing ring

004	Size
10A	Size 10, deviating flow
10	Size 10
14	Size 14
18	Size 18

005	Valve function
T32U	2x3/2-way valve, normally open
T32C	2x3/2-way valve, normally closed
T32H	2x3/2-way valve, 1x normally closed, 1x normally open
B52	5/2-way valve, double solenoid/bistable
M52	5/2-way valve, single solenoid/monostable
P53U	5/3-way valve, mid-position pressurised
P53E	5/3-way valve, mid-position exhausted
P53C	5/3-way valve, mid-position closed

006	Reset method for monostable/single solenoid valves
	None
A	Pneumatic spring
M	Mechanical spring
R	Mixed, pneumatic/mechanical spring

007	Pilot air
	Internal
Z	External

008	Manual override
	None
H	Non-detenting
S	Covered
Y	Detenting
T	Non-detenting, detenting with accessories

009	Pneumatic connection
M3	M3
G18	G1/8
G14	G1/4
M5	M5
M7	M7
Q4H	Push-in connector 4 mm, with connecting thread M7
Q6H	Push-in connector 6 mm, with connecting thread M7
Q3	Push-in connector 3 mm
Q4	Push-in connector 4 mm
Q6	Push-in connector 6 mm
Q8	Push-in connector 8 mm
Q10	Push-in connector 10 mm
T18	Push-in connector 1/8"
T532	Push-in connector 5/32"
T316	Push-in connector 3/16"
T316H	Push-in connector for 3/16", M7
T14	Push-in connector 1/4"
T14H	Push-in connector for 1/4", M7
T38	Push-in connector 3/8"
T516	Push-in connector 5/16"
T516H	Push-in connector 5/16", M7
F	Flange/sub-base

010	Exhaust
QN	With fitting
	No fitting
U	Silencer

011	Nominal operating voltage
	None
1	24 V DC
1A	24 V AC/50-60 Hz
4	5 V DC
5	12 V DC

012	Electrical connection
	None
P3	Without electrical sub-base
C1	Plug pattern type C, to EN 175301-803
E1	Individual connection with plug base
H2	Connection pattern H, horizontal plug
H3	Connection pattern H, vertical plug
S2	Connection pattern S, horizontal plug
S3	Connection pattern S, vertical connector
L1	Leads 0.5 m
L2	Leads 1 m
L3	Leads 2.5 m
L4	Leads 5 m
K6	Cable 0.5 m
K7	Cable 1 m
K8	Cable 2.5 m
K9	Cable 5 m
R8	Individual connector M8, 3-pin
R1	Individual connector M8, 4-pin
R3	Individual plug M12, to EN 61076-2-101
P1	Interface for pilot valve (CNOMO small)

013	Circuitry
	None
R	Holding current reduction with integrated protective circuit

## Type codes

014	Display
	None
L	LED



015	Electrical valve accessories
	None
C1	Connecting cable, 0.5 m
C2	Connecting cable 1 m
C3	Connecting cable 2.5 m
C4	Connecting cable, 5 m
D	Connector socket type C
D3	Connecting cable 2.5 m, with plug socket type C
D4	Connecting cable 5 m, with plug socket type C
D6	
D7	
D8	
DL3	Connecting cable 2.5 m, with plug socket type C, LED
DL4	Connecting cable 5 m, with plug socket type C, LED
DL5	Connecting cable 10 m, with plug socket type C, LED
E	
E3	Connecting cable 2.5 m, straight plug socket M12
E4	Connecting cable 5 m, straight plug socket M12
E6	Connecting cable 2.5 m, angled plug socket M12
E7	Connecting cable 5 m, angled plug socket M12
EL	
N1	Connecting cable 2.5 m, straight plug socket M8, 3-pin
N2	Connecting cable 5 m, straight plug socket M8, 3-pin
N3	Connecting cable 2.5 m, angled plug socket M8, 3-pin
N4	Connecting cable 5 m, angled plug socket M8, 3-pin
N5	Connecting cable 2.5 m, straight plug socket M8, 4-pin
N6	Connecting cable 5 m, straight plug socket M8, 4-pin
N7	Connecting cable 2.5 m, angled plug socket M8, 4-pin
N8	Connecting cable 5 m, angled plug socket M8, 4-pin
S1	Connecting cable, 0.5 m, S-connector
S2	Connecting cable 1 m, S-connector
S3	Connecting cable 2.5 m, S-connector
S4	Connecting cable, 5 m, S-plug
W1	Connecting cable, flying leads, 0.5 m
W2	Connecting cable, flying leads, 1 m
W3	Connecting cable, flying leads, 2.5 m
W4	Connecting cable, flying leads, 5 m
WS1	Connecting cable, S-plug with flying leads, 0.5 m
WS2	Connecting cable, S-plug with flying leads, 1 m
WS3	Connecting cable, S-plug with flying leads, 2.5 m
WS4	Connecting cable, S-plug with flying leads, 5 m

016	Version
	Expanded properties
S	Focused properties

017	Special material properties
	None
F1A	Recommended for production facilities for the manufacture of lithium-ion batteries

## Datasheet

Function  
5/2-way, single solenoid  
5/2-way, double solenoid valve  
5/3C, 5/3U, 5/3E

-  - Size 10 mm
-  - Flow rate  
80 ... 100 l/min
-  - Voltage  
5, 12 and 24 V DC



Circuit symbols → page 14

### General technical data VUVG-L

Valve function	M52-R	B52	M52-M	P53
Normal position	–	–	–	C <sup>1)</sup> U <sup>2)</sup> E <sup>3)</sup>
Stable position	Monostable	Bistable	Monostable	Monostable
Pneumatic spring return	Yes <sup>4)</sup>	–	No	–
Mechanical spring return	Yes <sup>4)</sup>	–	Yes	Yes
Vacuum operation at port 1	Only with external pilot air supply			
Design	Piston spool			
Sealing principle	Soft			
Actuation type	Electrical			
Type of control	Piloted			
Pilot air supply	Internal or external			
Exhaust function	Can be throttled			
Manual override	Choice of non-detenting, covered, non-detenting/detenting or detenting			
Type of mounting	Optionally via through-holes <sup>5)</sup> or on manifold rail			
Mounting position	Any			
Nominal width [mm]	2		1.4	2
Standard nominal flow rate [l/min]	100		80	90
Flow rate on manifold rail [l/min]	100		80	90
Switching time on/off [ms]	7/15	–	7/21	8/25
Changeover time [ms]	–	5	–	14
Size [mm]	10			
Connection	1, 2, 3, 4, 5, 12/14 M3			
Product weight [g]	38	49	37	
Certification	c UL us - Recognized (OL) RCM			
CE marking (see declaration of conformity) <sup>6)</sup>	To EU EMC Directive			
Corrosion resistance class CRC <sup>7)</sup>	2			

1) C=Normally closed/mid-position closed

2) U=Normally open/mid-position pressurised

3) E=Mid-position exhausted

4) Combined reset method

5) If several valves are to be screwed together via the through-holes to form a block, a minimum distance of 0.3 mm must be ensured by inserting spacers.

6) For information about the area of use, see the EC declaration of conformity at: [www.festo.com/catalogue/...](http://www.festo.com/catalogue/...) → Support/Downloads.

If the devices are subject to usage restrictions in residential, commercial or light-industrial environments, further measures for the reduction of the emitted interference may be necessary.

7) More information: [www.festo.com/x/topic/kbk](http://www.festo.com/x/topic/kbk)



## Datasheet

Operating and environmental conditions			M52-R <sup>1)</sup>	B52	M52-M <sup>2)</sup>	P53
Valve function			Compressed air to ISO 8573-1:2010 [7:4:4]			
Operating pressure	Internal	[MPa]	0.25 ... 0.8	0.15 ... 0.8	0.3 ... 0.8	0.3 ... 0.8
		[bar]	2.5 ... 8	1.5 ... 8	3 ... 8	3 ... 8
	External	[MPa]	-0.09 ... 1			-0.09 ... 0.8
		[bar]	-0.9 ... 10			-0.9 ... 8
Pilot pressure	[MPa]	0.25 ... 0.8	0.15 ... 0.8	0.3 ... 0.8		
	[bar]	2.5 ... 8	1.5 ... 8	3 ... 8		
Ambient temperature		[°C]	-5 ... +50, with holding current reduction -5 ... +60			
Temperature of medium		[°C]	-5 ... +50, with holding current reduction -5 ... +60			

1) Mixed, pneumatic/mechanical spring

2) Mechanical spring

Electrical data		
Electrical connection		Via E-box → page 110
Operating voltage	[V DC]	5, 12 and 24 ±10%
Power	[W]	1, reduced to 0.35 with holding current reduction
Duty cycle	[%]	100
Degree of protection to EN 60529		IP40 (with plug socket), IP65 (with M8)

Information on materials		
Housing		Wrought aluminium alloy
Seals		HNBR, NBR
Note on materials		RoHS-compliant
PWIS conformity		VDMA24364-B1/B2-L

Datasheet

Dimensions

Download CAD data → [www.festo.com](http://www.festo.com)

5/2-way and 5/3-way valve

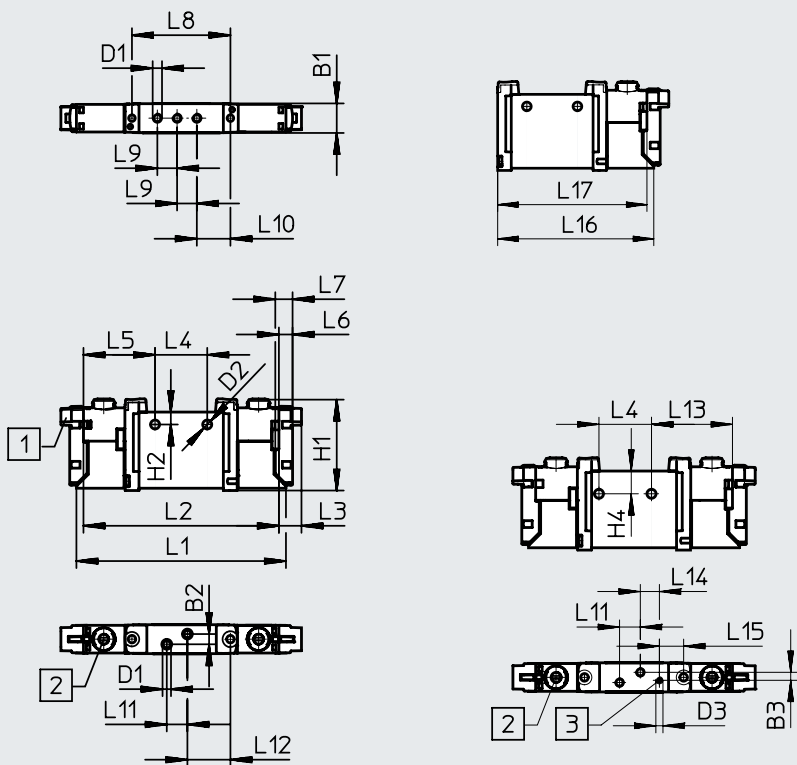

**Note**  
 More dimensions  
 E-boxes  
 → Page 112

[1] Electrical connection for solenoid valve, horizontal

[2] Manual override

[3] Port for external pilot air supply

Type	B1	B2	B3	D1	D2	D3	H1	H2	L1	L2	L3	L4	L5
VUVG-L10A...-M3...	10.2	3.6	2.83	M3	3.2	M3	32.5	4.4	74.3	69.3	8	18.5	25.4
VUVG-S10A...-M3...													

Type	L6	L7	L8	L9	L10	L11	L12	L13	L14	L15	L16	L17
VUVG-L10A...-M3...	4.85	6.15	34.9	7	11.9	7.3	15.25	28.5	6.7	8.54	57.06	54.56
VUVG-S10A...-M3...												

## Ordering data

Ordering data	Description	Part no.	Type	
<b>In-line valve M3, without E-box</b>				
	<b>5/2-way valve, single solenoid</b>			
	Internal pilot air supply	Pneumatic/mechanical spring return	566437	VUVG-L10A-M52-RT-M3-1P3
		Mechanical spring return	574345	VUVG-L10A-M52-MT-M3-1P3
	External pilot air supply	Pneumatic/mechanical spring return	566443	VUVG-L10A-M52-RZT-M3-1P3
		Mechanical spring return	574346	VUVG-L10A-M52-MZT-M3-1P3
	<b>5/2-way valve, double solenoid</b>			
	Internal pilot air supply		566438	VUVG-L10A-B52-T-M3-1P3
	External pilot air supply		566444	VUVG-L10A-B52-ZT-M3-1P3
	<b>5/3-way valve</b>			
	Internal pilot air supply	Mid-position closed, mechanical spring return	566439	VUVG-L10A-P53C-T-M3-1P3
		Mid-position exhausted, mechanical spring return	566440	VUVG-L10A-P53E-T-M3-1P3
		Mid-position pressurised, mechanical spring return	566441	VUVG-L10A-P53U-T-M3-1P3
External pilot air supply	Mid-position closed, mechanical spring return	566445	VUVG-L10A-P53C-ZT-M3-1P3	
	Mid-position exhausted, mechanical spring return	566446	VUVG-L10A-P53E-ZT-M3-1P3	
	Mid-position pressurised, mechanical spring return	566447	VUVG-L10A-P53U-ZT-M3-1P3	

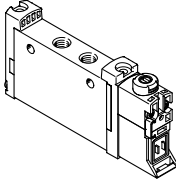
## Manifold assembly

### In-line valves for manifold assembly



#### Dimensions

Download CAD data → [www.festo.com](http://www.festo.com)

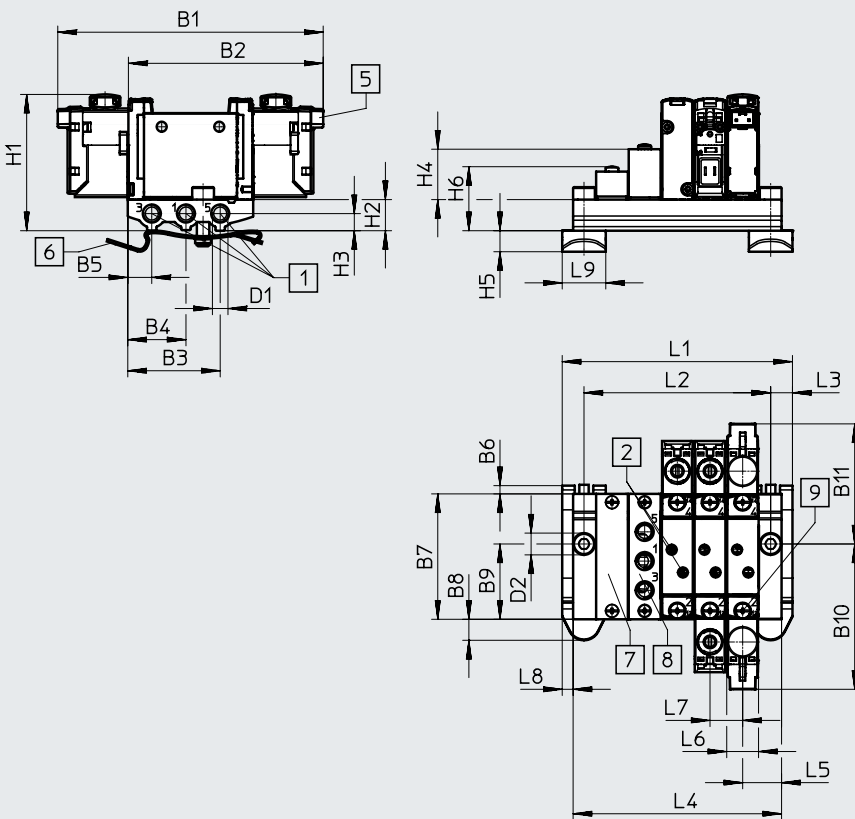

-  - **Note**

More dimensions

E-boxes

→ Page 112

[1] Ports 1, 3 and 5: M5 (at both ends)

[2] Ports 2 and 4: M3

[5] Electrical connection for E-boxes and accessories

[6] H-rail mounting (two M4x16 screws are required for mounting)

[7] Cover plate

[8] Supply plate, ports 1, 3 and 5: M5

[9] Valves/cover plate mounting on manifold rail: M2 thread

Type	B1	B2	B3	B4	B5	B6	B7	B8	B9	B10	B11	D1
VABM-L1-10AS-M5	85.3	62.6	29.7	18.7	7.7	3	40.3	6.8	24.2	46.7	38.6	M5

Type	D2 ∅	H1	H2	H3	H4	H5	H6	L3	L5	L6	L7	L8	L9
VABM-L1-10AS-M5	4.5	43.8	10	5.5	16.2	6.8	20.3	7	12.5	10.3	10.5	3.5	14

Valve positions	2	3	4	5	6	7	8	9	10	12	14	16
L1	42.5	53	63.5	74	84.5	95	105.5	116	126.5	147.5	168.5	189.5
L2	28.5	39	49.5	60	70.5	81	91.5	102	112.5	133.5	154.5	175.5
L4	35.5	46	56.5	67	77.5	88	98.5	109	119.5	140.5	161.5	182.5
Weight of VABM [g]	26	34	42	50	58	66	74	82	90	106	122	138

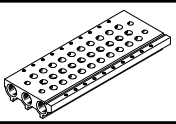

## Ordering data

Technical data – Manifold rails								
	Connection	KBK	Material <sup>2)</sup>	Operating pressure		Max. tightening torque for assembly [Nm]		
	1, 3, 5			[MPa]	[bar]	Valve	H-rail	Wall
	M5	2 <sup>1)</sup>	Wrought aluminium alloy	-0.09 ... 1	-0.9 ... 10	0.45	1.5	3

1) Corrosion resistance class CRC 2 to Festo standard FN 940070

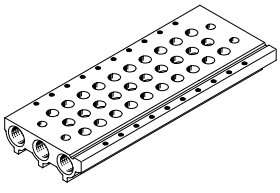
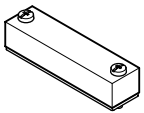

Moderate corrosion stress. Indoor applications in which condensation can occur. External visible parts with primarily decorative surface requirements which are in direct contact with a normal industrial environment.

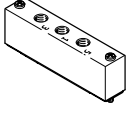
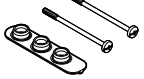
2) Information on materials: RoHS-compliant.

Ordering data – Manifold rail				
	Description		Part no.	Type
<b>Manifold rail for in-line valves (manifold assembly)</b>				
	For size M3	2 valve positions	566522	VABM-L1-10AS-M5-2
		3 valve positions	566523	VABM-L1-10AS-M5-3
		4 valve positions	566524	VABM-L1-10AS-M5-4
		5 valve positions	566525	VABM-L1-10AS-M5-5
		6 valve positions	566526	VABM-L1-10AS-M5-6
		7 valve positions	566527	VABM-L1-10AS-M5-7
		8 valve positions	566528	VABM-L1-10AS-M5-8
		9 valve positions	566529	VABM-L1-10AS-M5-9
		10 valve positions	566530	VABM-L1-10AS-M5-10
		12 valve positions	566531	VABM-L1-10AS-M5-12
		14 valve positions	566532	VABM-L1-10AS-M5-14
16 valve positions	566533	VABM-L1-10AS-M5-16		
<b>Cover plate</b> <span style="float: right;">Datasheets → Internet: vabb</span>				
	For valve position on manifold rail, including screws and seal		569986	VABB-L1-10A
<b>Separator</b> <span style="float: right;">Datasheets → Internet: vabd</span>				
	For creating pressure zones		570872	VABD-4.2-B
<b>Supply plate</b> <span style="float: right;">Datasheets → Internet: vabf</span>				
	For valve position on manifold rail, including screws and seal		569990	VABF-L1-10A-P3A4-M5
<b>Seals for in-line valves</b> <span style="float: right;">Datasheets → Internet: vabd</span>				
	For in-line valves M3	Delivery quantity: 10 sets (each with 2 screws and 1 seal)	566670	VABD-L1-10AX-S-M3

## Datasheet

Function  
2x 3/2C  
5/2-way, single solenoid  
5/2-way, double solenoid valve

-  - Size 10 mm
-  - Flow rate  
180 ... 195 l/min
-  - Voltage  
24 V DC



Circuit symbols → page 14

### General technical data VUVG-LK

Valve function	T32-A	M52-A	B52
Normal position	C <sup>1)</sup>	-	-
Stable position	Monostable		Bistable
Pneumatic spring return	Yes	Yes	-
Design	Piston spool		
Sealing principle	Soft		
Actuation type	Electrical		
Type of control	Piloted		
Pilot air supply	Internal		
Exhaust function	Can be throttled		
Manual override	Detenting, non-detenting		
Type of mounting	Optionally via through-holes <sup>2)</sup> or on manifold rail		
Mounting position	Any		
Standard nominal flow rate	[l/min]	180	195
Switching time on/off	[ms]	12/14	14/17
Changeover time	[ms]	-	7
Size	[mm]	10	
Connection	2, 4	M5	
Product weight	[g]	55	57
Corrosion resistance class CRC <sup>3)</sup>	0		
Certificate-issuing authority	UL MH19482		
Certification	c UL us - Recognized (OL)		

1) C = normally closed

2) If several valves are to be screwed together via the through-holes to form a block, a minimum distance of 0.3 mm must be ensured by inserting spacers

3) More information: [www.festo.com/x/topic/kbk](http://www.festo.com/x/topic/kbk)

### Safety characteristics

Max. positive test pulse with 0 signal	[μs]	1600
Max. negative test pulse with 1 signal	[μs]	3000
Shock resistance	Shock test with severity level 1 to FN 942017-5 and EN 60068-2-27	
Vibration resistance	Transport application test with severity level 1 to FN 942017-4 and EN 60068-2-6	

## Datasheet

Operating and environmental conditions				
Valve function		T32-A <sup>1)</sup>	M52-A <sup>1)</sup>	B52
Operating medium	Compressed air to ISO 8573-1:2010 [7:4:4]			
Note on the operating/pilot medium	Lubricated operation possible (in which case lubricated operation will always be required)			
Operating pressure	[MPa]	0.15 ... 0.7	0.25 ... 0.7	0.15 ... 0.7
	[bar]	1.5 ... 7	2.5 ... 7	1.5 ... 7
Ambient temperature	[°C]	-5 ... +50		
Temperature of medium	[°C]	-5 ... +50		

1) Pneumatic spring

Electrical data	
Electrical connection	Via E-box → page 112
Operating voltage	[V DC] 24 ±10%
Power	[W] 0.7
Duty cycle	[%] 100
Degree of protection to EN 60529	IP40 (with plug socket), IP65 (with M8)
Signal status indication	LED
Maximum switching frequency	[Hz] 2

Information on materials	
Housing	Wrought aluminium alloy
Seals	HNBR, NBR
Note on materials	RoHS-compliant
PWIS conformity	VDMA24364 zone III

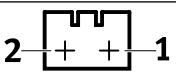
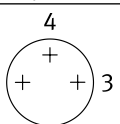
Pin allocation for E-box			
	Pin		Description
<b>Rectangular plug, connection pattern H</b>			
	1	+ or -	Protective circuit without holding current reduction
	2	+ or -	
<b>Round plug, M8, 3-pin</b>			
	1	Not used	Protective circuit without holding current reduction
	3	+ or -	
	4	+ or -	

### Protective circuit without holding current reduction

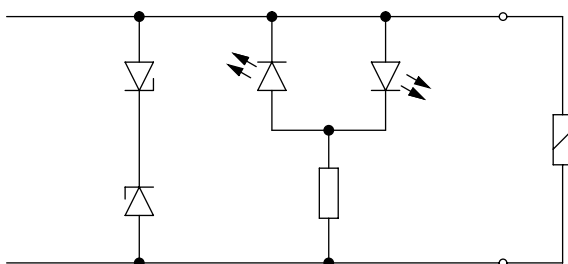

The solenoid coils have a protective circuit to arrest sparks and protect against polarity reversal.

Datasheet

Dimensions

Download CAD data → [www.festo.com](http://www.festo.com)

2x 3/2-way, 5/2-way valve, double solenoid

5/2-way valve, single solenoid

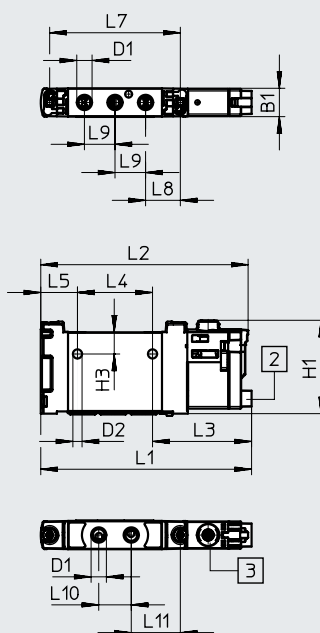
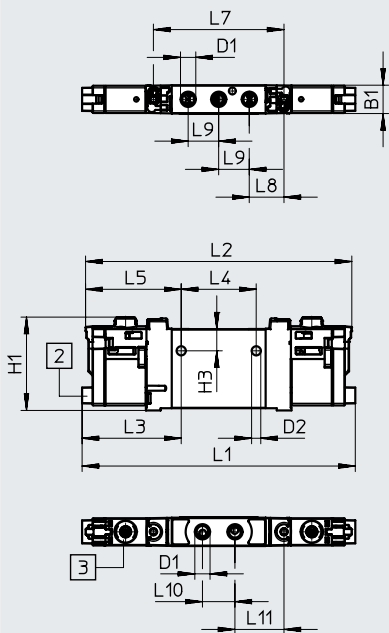

**Note**  
 More dimensions  
 E-boxes  
 → Page 112

[2] Horizontal electrical connection    [3] Manual override

Type	B1	D1	D2	H1	H3	L1	L2	L3
VUVG-LK10-T32C-...-M5...	10.2	M5	3.3	33.6	7.8	98.3	95.8	35.7
VUVG-LK10-B52-...-M5...								
VUVG-LK10-M52-...-M5...						75.9	74.6	

Type	L4	L5	L7	L8	L9	L10	L11
VUVG-LK10-T32C-...-M5...	27	34.4	47	12.5	11	11.7	17.7
VUVG-LK10-B52-...-M5...							
VUVG-LK10-M52-...-M5...		13.2					



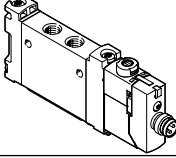
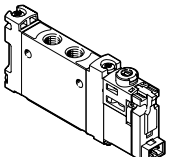
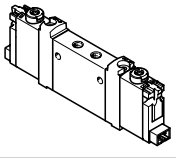

## Ordering data

## ★ Core Range

Ordering data	Description	Part no.	Type
<b>In-line valve M5, with E-box R8</b>			
	<b>2x 3/2-way valve</b>		
	Internal pilot air supply	Normally closed, pneumatic spring return	★ 8042542 VUVG-LK10-T32C-AT-M5-1R8L-S
	<b>5/2-way valve, single solenoid</b>		
	Internal pilot air supply	Pneumatic spring return	★ 8042543 VUVG-LK10-M52-AT-M5-1R8L-S
	<b>5/2-way valve, double solenoid</b>		
	Internal pilot air supply	★ 8042544 VUVG-LK10-B52-T-M5-1R8L-S	
<b>In-line valve M5, with E-box H2</b>			
	<b>2x 3/2-way valve</b>		
	Internal pilot air supply	Normally closed, pneumatic spring return	★ 8042538 VUVG-LK10-T32C-AT-M5-1H2L-S
	<b>5/2-way valve, single solenoid</b>		
	Internal pilot air supply	Pneumatic spring return	★ 8042539 VUVG-LK10-M52-AT-M5-1H2L-S
	<b>5/2-way valve, double solenoid</b>		
	Internal pilot air supply	★ 8042540 VUVG-LK10-B52-T-M5-1H2L-S	
<b>Ordering data</b>			
Ordering data	Description	Part no.	Type
<b>In-line valve M5, for battery manufacturing</b>			
	<b>2x 3/2-way valve</b>		
	Internal pilot air supply	Normally closed, pneumatic spring return	8173199 VUVG-LK10-T32C-AT-M5-1H2L-F1A
	<b>5/2-way valve, single solenoid</b>		
	Internal pilot air supply	Pneumatic spring return	8173200 VUVG-LK10-M52-AT-M5-1H2L-F1A
	<b>5/2-way valve, double solenoid</b>		
	Internal pilot air supply	8173201 VUVG-LK10-B52-T-M5-1H2L-F1A	

## Datasheet

Function  
2x 3/2C  
5/2-way, single solenoid  
5/2-way, double solenoid valve

-  - Size 10 mm
-  - Flow rate  
280 ... 340 l/min
-  - Voltage  
24 V DC

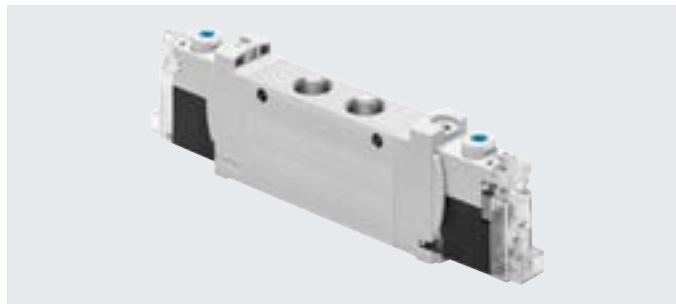

Circuit symbols → page 14

### General technical data VUVG-LK

Valve function	T32-A	M52-A	B52
Normal position	C <sup>1)</sup>	-	-
Stable position	Monostable		Bistable
Pneumatic spring return	Yes	Yes	-
Design	Piston spool		
Sealing principle	Soft		
Actuation type	Electrical		
Type of control	Piloted		
Pilot air supply	Internal		
Exhaust function	Can be throttled		
Manual override	Detenting, non-detenting		
Type of mounting	Optionally via through-holes <sup>2)</sup> or on manifold rail		
Mounting position	Any		
Standard nominal flow rate	[l/min]	280	340
Switching time on/off	[ms]	12/14	14/17
Changeover time	[ms]	-	7
Size	[mm]	10	
Connection	2, 4	M7	
Product weight	[g]	55	45
Corrosion resistance class CRC <sup>3)</sup>	0		
Certificate-issuing authority	UL MH19482		
Certification	c UL us - Recognized (OL)		

1) C = normally closed

2) If several valves are to be screwed together via the through-holes to form a block, a minimum distance of 0.3 mm must be ensured by inserting spacers

3) More information: [www.festo.com/x/topic/kbk](http://www.festo.com/x/topic/kbk)

### Safety characteristics

Max. positive test pulse with 0 signal	[μs]	1600
Max. negative test pulse with 1 signal	[μs]	3000
Shock resistance	Shock test with severity level 1 to FN 942017-5 and EN 60068-2-27	
Vibration resistance	Transport application test with severity level 1 to FN 942017-4 and EN 60068-2-6	

## Datasheet

Operating and environmental conditions				
Valve function		T32-A <sup>1)</sup>	M52-A <sup>1)</sup>	B52
Operating medium		Compressed air to ISO 8573-1:2010 [7:4:4]		
Note on the operating/pilot medium		Lubricated operation possible (in which case lubricated operation will always be required)		
Operating pressure	[MPa]	0.15 ... 0.7	0.25 ... 0.7	0.15 ... 0.7
	[bar]	1.5 ... 7	2.5 ... 7	1.5 ... 7
Ambient temperature	[°C]	-5 ... +50		
Temperature of medium	[°C]	-5 ... +50		

1) Pneumatic spring

Electrical data	
Electrical connection	Via E-box → page 110
Operating voltage	[V DC] 24 ±10%
Power	[W] 0.7
Duty cycle	[%] 100
Degree of protection to EN 60529	IP40 (with plug socket), IP65 (with M8)
Signal status indication	LED
Maximum switching frequency	[Hz] 2

Information on materials	
Housing	Wrought aluminium alloy
Seals	HNBR, NBR
Note on materials	RoHS-compliant
PWIS conformity	VDMA24364 zone III

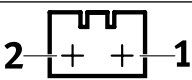
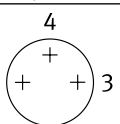
Pin allocation for E-box			
	Pin		Description
<b>Rectangular plug, connection pattern H</b>			
	1	+ or -	Protective circuit without holding current reduction
	2	+ or -	
<b>Round plug, M8, 3-pin</b>			
	1	Not used	Protective circuit without holding current reduction
	3	+ or -	
	4	+ or -	

### Protective circuit without holding current reduction

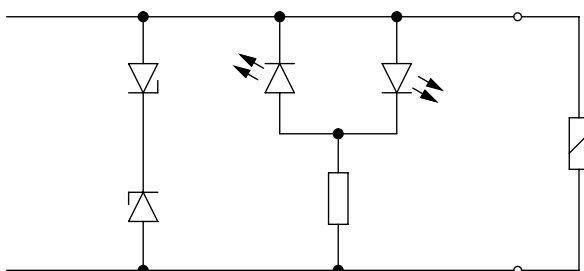

The solenoid coils have a protective circuit to arrest sparks and protect against polarity reversal.

## Datasheet

### Dimensions

Download CAD data → [www.festo.com](http://www.festo.com)

2x 3/2-way, 5/2-way valve, double solenoid

5/2-way valve, single solenoid

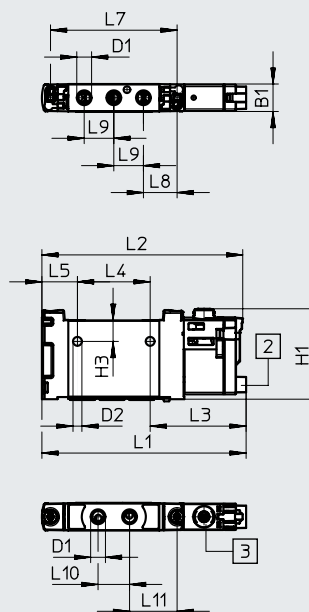
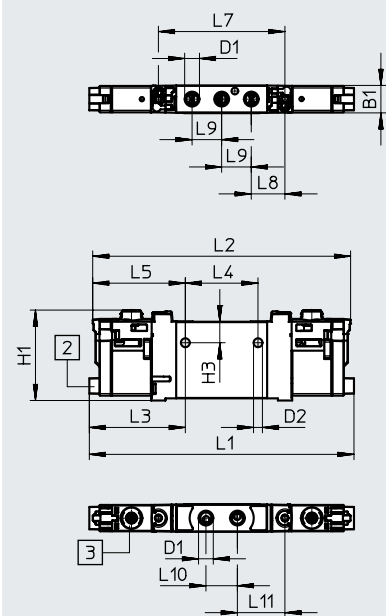

 **Note**  
More dimensions  
E-boxes  
→ Page 112

[2] Horizontal electrical connection

[3] Manual override

Type	B1	D1	D2	H1	H3	L1	L2	L3
VUVG-LK10-T32C-...-M7...	10.2	M7	3.3	33.6	7.8	98.3	95.8	35.7
VUVG-LK10-B52-...-M7...						75.9	74.6	35.7
VUVG-LK10-M52-...-M7...								

Type	L4	L5	L7	L8	L9	L10	L11
VUVG-LK10-T32C-...-M7...	27	34.4	47	12.5	11	11.7	17.7
VUVG-LK10-B52-...-M7...		13.2					
VUVG-LK10-M52-...-M7...							

## Ordering data

## ★ Core Range

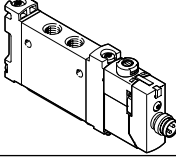
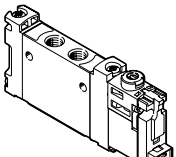
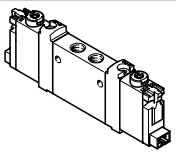

Ordering data		Description	Part no.	Type
<b>In-line valve M7, with E-box R8</b>				
	<b>2x 3/2-way valve</b>			
	Internal pilot air supply	Normally closed, pneumatic spring return	★ 8042550	VUVG-LK10-T32C-AT-M7-1R8L-S
	<b>5/2-way valve, single solenoid</b>			
	Internal pilot air supply	Pneumatic spring return	★ 8042551	VUVG-LK10-M52-AT-M7-1R8L-S
	<b>5/2-way valve, double solenoid</b>			
	Internal pilot air supply		★ 8042552	VUVG-LK10-B52-T-M7-1R8L-S
<b>In-line valve M7, with E-box H2</b>				
	<b>2x 3/2-way valve</b>			
	Internal pilot air supply	Normally closed, pneumatic spring return	★ 8042546	VUVG-LK10-T32C-AT-M7-1H2L-S
	<b>5/2-way valve, single solenoid</b>			
	Internal pilot air supply	Pneumatic spring return	★ 8042547	VUVG-LK10-M52-AT-M7-1H2L-S
	<b>5/2-way valve, double solenoid</b>			
	Internal pilot air supply		★ 8042548	VUVG-LK10-B52-T-M7-1H2L-S
<b>In-line valve M7, for battery manufacturing</b>				
	<b>2x 3/2-way valve</b>			
	Internal pilot air supply	Normally closed, pneumatic spring return	8173202	VUVG-LK10-T32C-AT-M7-1H2L-F1A
	<b>5/2-way valve, single solenoid</b>			
	Internal pilot air supply	Pneumatic spring return	8173203	VUVG-LK10-M52-AT-M7-1H2L-F1A
	<b>5/2-way valve, double solenoid</b>			
	Internal pilot air supply		8173204	VUVG-LK10-B52-T-M7-1H2L-F1A

## Datasheet

### Function

2x 3/2C, 2x 3/2U, 2x 3/2H  
 5/2-way, single solenoid  
 5/2-way, double solenoid valve  
 5/3C, 5/3U, 5/3E

Circuit symbols → page 14

-  - Size 10 mm
-  - Flow rate  
125 ... 220 l/min
-  - Voltage  
5, 12 and 24 V DC



### General technical data VUVG-L M5

Valve function	T32-A			T32-M			M52-R	B52	M52-M	P53		
Normal position	C <sup>1)</sup>	U <sup>2)</sup>	H <sup>4)</sup>	C <sup>1)</sup>	U <sup>2)</sup>	H <sup>4)</sup>	-	-	-	C <sup>1)</sup>	U <sup>2)</sup>	E <sup>3)</sup>
Stable position	Monostable							Bistable	Monostable	Monostable		
Pneumatic spring return	Yes			No			Yes <sup>5)</sup>	-	No	-		
Mechanical spring return	No			Yes			Yes <sup>5)</sup>	-	Yes	Yes		
Vacuum operation at port 1	No			Only with external pilot air supply								
Design	Piston spool											
Sealing principle	Soft											
Actuation type	Electrical											
Type of control	Piloted											
Pilot air supply	Internal or external											
Exhaust function	Can be throttled											
Manual override	Choice of non-detenting, covered, non-detenting/detenting or detenting											
Type of mounting	Optionally via through-holes <sup>6)</sup> or on manifold rail											
Mounting position	Any											
Nominal width	[mm]	2.7	1.9	1.8			3.2		2.2		3.2	
Standard nominal flow rate	[l/min]	150	135	135	135		220		220		210	
Flow rate on manifold rail	[l/min]	150	135	125	125		220		190		210	
Switching time on/off	[ms]	6/15	8/11				7/17	-	8/24		11/30	
Changeover time	[ms]	-						7	-	14		
Size	[mm]	10										
Connection	1, 2, 3, 4, 5 12/14	M5 M3										
Product weight	[g]	55	54				45	55	44	55		
Certificate-issuing authority	VUVG-...-F1A	UL MH19482										
Certification		c UL us - Recognized (OL) RCM										
CE marking (see declaration of conformity) <sup>7)</sup>		To EU EMC Directive										
Corrosion resistance class CRC <sup>8)</sup>		2										

- 1) C=Normally closed/mid-position closed
- 2) U=Normally open/mid-position pressurised
- 3) E=Mid-position exhausted
- 4) H=2x 3/2-way valve in one housing with 1x normally closed and 1x normally open
- 5) Combined reset method
- 6) If several valves are to be screwed together via the through-holes to form a block, a minimum distance of 0.3 mm must be ensured by inserting spacers.
- 7) For information about the area of use, see the EC declaration of conformity at: [www.festo.com/catalogue/...](http://www.festo.com/catalogue/...) → Support/Downloads.  
If the devices are subject to usage restrictions in residential, commercial or light-industrial environments, further measures for the reduction of the emitted interference may be necessary.
- 8) More information: [www.festo.com/x/topic/kbk](http://www.festo.com/x/topic/kbk)

## Datasheet

Operating and environmental conditions			T32-A <sup>1)</sup>	T32-M <sup>3)</sup>	M52-R <sup>2)</sup>	B52	M52-M <sup>3)</sup>	P53
Valve function			Compressed air to ISO 8573-1:2010 [7:4:4]					
Operating pressure	Internal	[MPa]	0.15 ... 0.8	0.25 ... 0.8	0.25 ... 0.8	0.15 ... 0.8	0.3 ... 0.8	0.3 ... 0.8
		[bar]	1.5 ... 8	2.5 ... 8	2.5 ... 8	1.5 ... 8	3 ... 8	3 ... 8
	External	[MPa]	0.15 ... 1	-0.09 ... 1			-0.09 ... 0.8	-0.09 ... 1
		[bar]	1.5 ... 10	-0.9 ... 10			-0.9 ... 8	-0.9 ... 10
Pilot pressure	[MPa]	0.15 ... 0.8	0.2 ... 0.8	0.25 ... 0.8	0.15 ... 0.8	0.3 ... 0.8		
	[bar]	1.5 ... 8	2 ... 8	2.5 ... 8	1.5 ... 8	3 ... 8		
Ambient temperature		[°C]	-5 ... +50, with holding current reduction -5 ... +60					
Temperature of medium		[°C]	-5 ... +50, with holding current reduction -5 ... +60					

- 1) Pneumatic spring  
2) Mixed, pneumatic/mechanical spring  
3) Mechanical spring

Electrical data		
Electrical connection		Via E-box → page 110
Operating voltage	[V DC]	5, 12 and 24 ±10%
Power	[W]	1, reduced to 0.35 with holding current reduction
Duty cycle	[%]	100
Degree of protection to EN 60529		IP40 (with plug socket), IP65 (with M8)

Information on materials	
Housing	Wrought aluminium alloy
Seals	HNBR, NBR
Note on materials	RoHS-compliant
PWIS conformity	VDMA24364-B1/B2-L

Datasheet

Dimensions

Download CAD data → [www.festo.com](http://www.festo.com)

2x 3/2-way, 5/2-way and 5/3-way valve

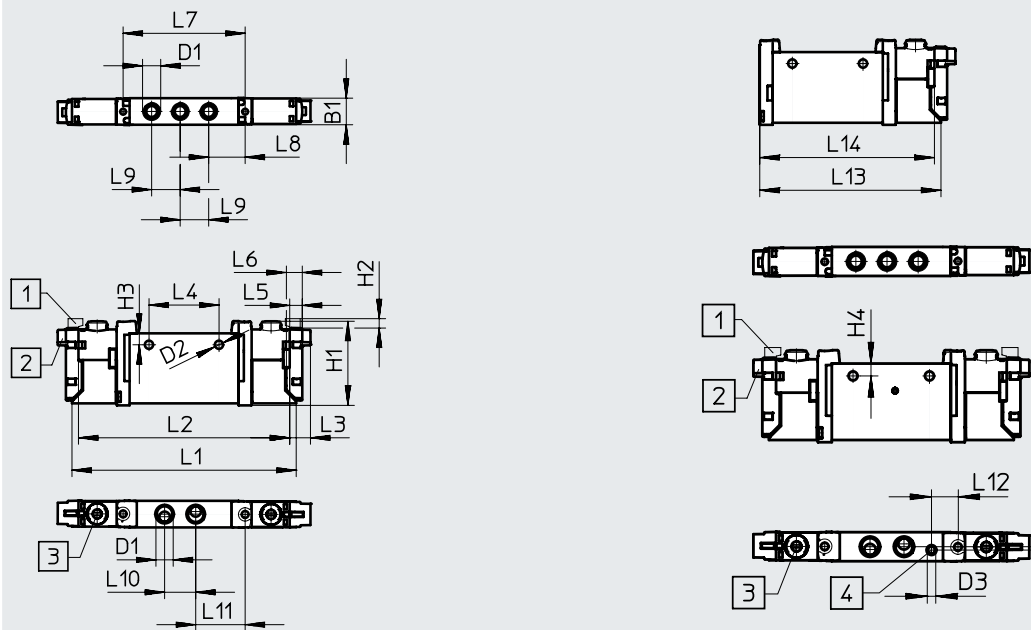

**Note**  
 More dimensions  
 E-boxes  
 → Page 112

[1] Vertical electrical connection      [2] Horizontal electrical connection      [3] Manual override      [4] Port for external pilot air supply

Type	B1	B2	D1	D2	D3	H1	H2	H3	L1	L2	L3	L4
VUVG-L-10 ...-M5...	10.2	-	M5	3.2	M3	32.5	3.6	4.4	86.5	81.5	8	27
VUVG-S-10 ...-M5...												

Type	L5	L6	L7	L8	L9	L10	L11	L12	L13	L14
VUVG-L-10 ...-M5...	4.85	6.15	47	14	11	12	19	-	69.2	66.7
VUVG-S-10 ...-M5...										



## Ordering data

## ★ Core Range

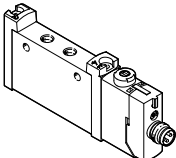
Ordering data	Description	Part no.	Type
<b>In-line valve M5, with E-box R8</b>			
	<b>5/3-way valve</b>		
	Internal pilot air supply	Mid-position closed, mechanical spring return	★ 577346

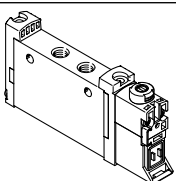
Ordering data	Description	Part no.	Type	
<b>In-line valve M5, without E-box</b>				
	<b>2x 3/2-way valve</b>			
	Internal pilot air supply	Normally closed, pneumatic spring return	566454	VUVG-L10-T32C-AT-M5-1P3
		Normally open, pneumatic spring return	566455	VUVG-L10-T32U-AT-M5-1P3
		1x normally open, 1x normally closed, pneumatic spring return	566456	VUVG-L10-T32H-AT-M5-1P3
		Normally closed, mechanical spring return	574348	VUVG-L10-T32C-MT-M5-1P3
		Normally open, mechanical spring return	574349	VUVG-L10-T32U-MT-M5-1P3
		1x normally open, 1x normally closed, mechanical spring return	574350	VUVG-L10-T32H-MT-M5-1P3
	External pilot air supply	Normally closed, pneumatic spring return	566463	VUVG-L10-T32C-AZT-M5-1P3
		Normally open, pneumatic spring return	566464	VUVG-L10-T32U-AZT-M5-1P3
		1x normally open, 1x normally closed, pneumatic spring return	566465	VUVG-L10-T32H-AZT-M5-1P3
		Normally closed, mechanical spring return	574352	VUVG-L10-T32C-MZT-M5-1P3
		Normally open, mechanical spring return	574353	VUVG-L10-T32U-MZT-M5-1P3
		1x normally open, 1x normally closed, mechanical spring return	574354	VUVG-L10-T32H-MZT-M5-1P3
	<b>5/2-way valve, single solenoid</b>			
	Internal pilot air supply	Pneumatic/mechanical spring return	566457	VUVG-L10-M52-RT-M5-1P3
		Mechanical spring return	574351	VUVG-L10-M52-MT-M5-1P3
External pilot air supply	Pneumatic/mechanical spring return	566466	VUVG-L10-M52-RZT-M5-1P3	
	Mechanical spring return	574355	VUVG-L10-M52-MZT-M5-1P3	

## Ordering data

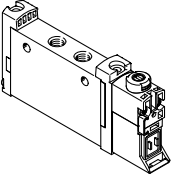
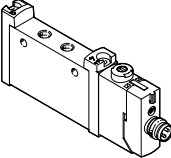
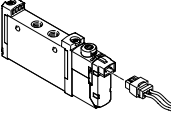
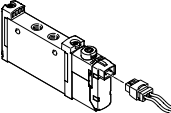
Ordering data	Description	Part no.	Type	
<b>In-line valve M5, without E-box</b>				
	<b>5/2-way valve, double solenoid</b>			
	Internal pilot air supply	566458	VUVG-L10-B52-T-M5-1P3	
	External pilot air supply	566467	VUVG-L10-B52-ZT-M5-1P3	
	<b>5/3-way valve</b>			
	Internal pilot air supply	Mid-position closed, mechanical spring return	566459	VUVG-L10-P53C-T-M5-1P3
		Mid-position exhausted, mechanical spring return	566460	VUVG-L10-P53E-T-M5-1P3
		Mid-position pressurised, mechanical spring return	566461	VUVG-L10-P53U-T-M5-1P3
	External pilot air supply	Mid-position closed, mechanical spring return	566468	VUVG-L10-P53C-ZT-M5-1P3
		Mid-position exhausted, mechanical spring return	566469	VUVG-L10-P53E-ZT-M5-1P3
Mid-position pressurised, mechanical spring return		566470	VUVG-L10-P53U-ZT-M5-1P3	
<b>In-line valve M5, with E-box R8</b>				
	<b>2x 3/2-way valve</b>			
	Internal pilot air supply	Normally closed, pneumatic spring return	577347	VUVG-L10-T32C-AT-M5-1R8L
		Normally open, pneumatic spring return	8031466	VUVG-L10-T32U-AT-M5-1R8L
		1x normally open, 1x normally closed, pneumatic spring return	8031467	VUVG-L10-T32H-AT-M5-1R8L
		Normally closed, mechanical spring return	8031468	VUVG-L10-T32C-MT-M5-1R8L
		Normally open, mechanical spring return	8031469	VUVG-L10-T32U-MT-M5-1R8L
		1x normally open, 1x normally closed, mechanical spring return	8031470	VUVG-L10-T32H-MT-M5-1R8L
	<b>5/2-way valve, single solenoid</b>			
	Internal pilot air supply	Pneumatic/mechanical spring return	572634	VUVG-L10-M52-RT-M5-1R8L
		Mechanical spring return	8031472	VUVG-L10-M52-MT-M5-1R8L
	<b>5/2-way valve, double solenoid</b>			
	Internal pilot air supply	576664	VUVG-L10-B52-T-M5-1R8L	
	<b>5/3-way valve</b>			
	Internal pilot air supply	Mid-position exhausted, mechanical spring return	8031475	VUVG-L10-P53E-T-M5-1R8L
		Mid-position pressurised, mechanical spring return	8031476	VUVG-L10-P53U-T-M5-1R8L
<b>In-line valve M5, with E-box H2</b>				
	<b>5/2-way valve, single solenoid</b>			
	Internal pilot air supply	Pneumatic/mechanical spring return	577316	VUVG-L10-M52-RT-M5-1H2L-W1
		Mechanical spring return	578162	VUVG-L10-M52-MT-M5-1H2L-W1
	<b>5/2-way valve, double solenoid</b>			
Internal pilot air supply	577317	VUVG-L10-B52-T-M5-1H2L-W1		
<b>Semi in-line valve M5, with E-box H2</b>				
	<b>5/2-way valve, single solenoid</b>			
	Internal pilot air supply	Pneumatic/mechanical spring return	577324	VUVG-S10-M52-RT-M5-1H2L-W1

## Ordering data

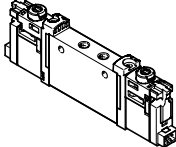

Ordering data	Description	Part no.	Type	
<b>In-line valve M5, suited for battery manufacturing</b>				
	<b>2x 3/2-way valve</b>			
	Internal pilot air supply	Normally closed, mechanical spring return	8164322	VUVG-L10-T32C-MT-M5-1H2L-F1A
		Normally open, pneumatic spring return	8164323	VUVG-L10-T32U-AT-M5-1H2L-F1A
		Normally open, mechanical spring return	8164324	VUVG-L10-T32U-MT-M5-1H2L-F1A
		1x normally open, 1x normally closed, pneumatic spring return	8164325	VUVG-L10-T32H-AT-M5-1H2L-F1A
		1x normally open, 1x normally closed, mechanical spring return	8164326	VUVG-L10-T32H-MT-M5-1H2L-F1A
	External pilot air supply	Normally closed, pneumatic spring return	8164331	VUVG-L10-T32C-AZT-M5-1H2L-F1A
		Normally closed, mechanical spring return	8164332	VUVG-L10-T32C-MZT-M5-1H2L-F1A
		Normally open, pneumatic spring return	8164333	VUVG-L10-T32U-AZT-M5-1H2L-F1A
		Normally open, mechanical spring return	8164334	VUVG-L10-T32U-MZT-M5-1H2L-F1A
		1x normally open, 1x normally closed, pneumatic spring return	8164335	VUVG-L10-T32H-AZT-M5-1H2L-F1A
	1x normally open, 1x normally closed, mechanical spring return	8164336	VUVG-L10-T32H-MZT-M5-1H2L-F1A	
	<b>5/2-way valve, single solenoid</b>			
	Internal pilot air supply	Mechanical spring return	8164327	VUVG-L10-M52-MT-M5-1H2L-F1A
	External pilot air supply	Pneumatic/mechanical spring return	8164337	VUVG-L10-M52-RZT-M5-1H2L-F1A
		Mechanical spring return	8164338	VUVG-L10-M52-MZT-M5-1H2L-F1A
	<b>5/2-way valve, double solenoid</b>			
	External pilot air supply		8164339	VUVG-L10-B52-ZT-M5-1H2L-F1A
<b>5/3-way valve</b>				
Internal pilot air supply	Mid-position closed	8164328	VUVG-L10-P53C-T-M5-1H2L-F1A	
	Mid-position exhausted	8164329	VUVG-L10-P53E-T-M5-1H2L-F1A	
	Mid-position pressurised	8164330	VUVG-L10-P53U-T-M5-1H2L-F1A	
External pilot air supply	Mid-position closed	8164340	VUVG-L10-P53C-ZT-M5-1H2L-F1A	
	Mid-position exhausted	8164341	VUVG-L10-P53E-ZT-M5-1H2L-F1A	
	Mid-position pressurised	8164342	VUVG-L10-P53U-ZT-M5-1H2L-F1A	

## Datasheet

### Function

2x 3/2C, 2x 3/2U, 2x 3/2H  
 5/2-way, single solenoid  
 5/2-way, double solenoid valve  
 5/3C, 5/3U, 5/3E

Circuit symbols → page 14

-  - Size 10 mm
-  - Flow rate  
130 ... 380 l/min
-  - Voltage  
5, 12 and 24 V DC

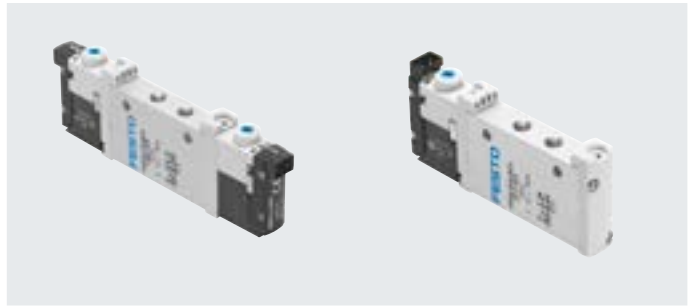

### General technical data VUVG-L M7

Valve function	T32-A			T32-M			M52-R	B52	M52-M	P53			
Normal position	C <sup>1)</sup>	U <sup>2)</sup>	H <sup>4)</sup>	C <sup>1)</sup>	U <sup>2)</sup>	H <sup>4)</sup>	–	–	–	C <sup>1)</sup>	U <sup>2)</sup>	E <sup>3)</sup>	
Stable position	Monostable							Bistable	Monostable	Monostable			
Pneumatic spring return	Yes			No			Yes <sup>5)</sup>	–	No	–			
Mechanical spring return	No			Yes			Yes <sup>5)</sup>	–	Yes	Yes			
Vacuum operation at port 1	No			Only with external pilot air supply									
Design	Piston spool												
Sealing principle	Soft												
Actuation type	Electrical												
Type of control	Piloted												
Pilot air supply	Internal or external												
Exhaust function	Can be throttled												
Manual override	Choice of non-detenting, covered, non-detenting/detenting or detenting												
Type of mounting	Optional via through-holes <sup>6)</sup> or on manifold rail												
Mounting position	Any												
Nominal width	[mm]	2.7		2.0	1.9	1.9	4.0		2.8		3.5		
Standard nominal flow rate	[l/min]	190		155	155	155	330	380	320		320		
Flow rate on manifold rail	[l/min]	170		140	130	130	320	340	290		300		
Switching time on/off	[ms]	6/15		8/11			7/17		–		8/24		
Changeover time	[ms]	–							7		14		
Size	[mm]	10											
Connection	1, 2, 3, 4, 5	M7											
	12/14	M3											
Product weight	[g]	55			54			45	55	44		55	
Certificate-issuing authority	VUVG-...-F1A	UL MH19482											
Certification		c UL us - Recognized (OL)											
		RCM											
CE marking (see declaration of conformity) <sup>7)</sup>		To EU EMC Directive											
Corrosion resistance class CRC <sup>8)</sup>		2											

1) C=Normally closed/mid-position closed

2) U=Normally open/mid-position pressurised

3) E=Mid-position exhausted

4) H=2x 3/2-way valve in one housing with 1x normally closed and 1x normally open

5) Combined reset method

6) If several valves are to be screwed together via the through-holes to form a block, a minimum distance of 0.3 mm must be ensured by inserting spacers.

7) For information about the area of use, see the EC declaration of conformity at: [www.festo.com/catalogue/...](http://www.festo.com/catalogue/...) → Support/Downloads.

If the devices are subject to usage restrictions in residential, commercial or light-industrial environments, further measures for the reduction of the emitted interference may be necessary.

8)

More information: [www.festo.com/x/topic/kbk](http://www.festo.com/x/topic/kbk)

## Datasheet

Operating and environmental conditions			T32-A <sup>1)</sup>	T32-M <sup>3)</sup>	M52-R <sup>2)</sup>	B52	M52-M <sup>3)</sup>	P53
Valve function			Compressed air to ISO 8573-1:2010 [7:4:4]					
Operating pressure	Internal	[MPa]	0.15 ... 0.8	0.25 ... 0.8	0.25 ... 0.8	0.15 ... 0.8	0.3 ... 0.8	
		[bar]	1.5 ... 8	2.5 ... 8	2.5 ... 8	1.5 ... 8	3 ... 8	
	External	[MPa]	0.15 ... 1	-0.09 ... 1			-0.09 ... 0.8	-0.09 ... 1
		[bar]	1.5 ... 10	-0.9 ... 10			-0.9 ... 8	-0.9 ... 10
Pilot pressure		[MPa]	0.15 ... 0.8	0.2 ... 0.8	0.25 ... 0.8	0.15 ... 0.8	0.3 ... 0.8	0.3 ... 0.8
		[bar]	1.5 ... 8	2 ... 8	2.5 ... 8	1.5 ... 8	3 ... 8	3 ... 8
Ambient temperature		[°C]	-5 ... +50, with holding current reduction -5 ... +60					
Temperature of medium		[°C]	-5 ... +50, with holding current reduction -5 ... +60					

1) Pneumatic spring

2) Mixed, pneumatic/mechanical spring

3) Mechanical spring

## Electrical data

Electrical connection		Via E-box → page 110
Operating voltage	[V DC]	5, 12, 24 ±10%
Power	[W]	1, reduced to 0.35 with holding current reduction
Duty cycle	[%]	100
Degree of protection to EN 60529		IP40 (with plug socket), IP65 (with M8)

## Information on materials

Housing	Wrought aluminium alloy
Seals	HNBR, NBR
Note on materials	RoHS-compliant
PWIS conformity	VDMA24364-B1/B2-L

Datasheet

Dimensions

Download CAD data → [www.festo.com](http://www.festo.com)

2x 3/2-way, 5/2-way and 5/3-way valve

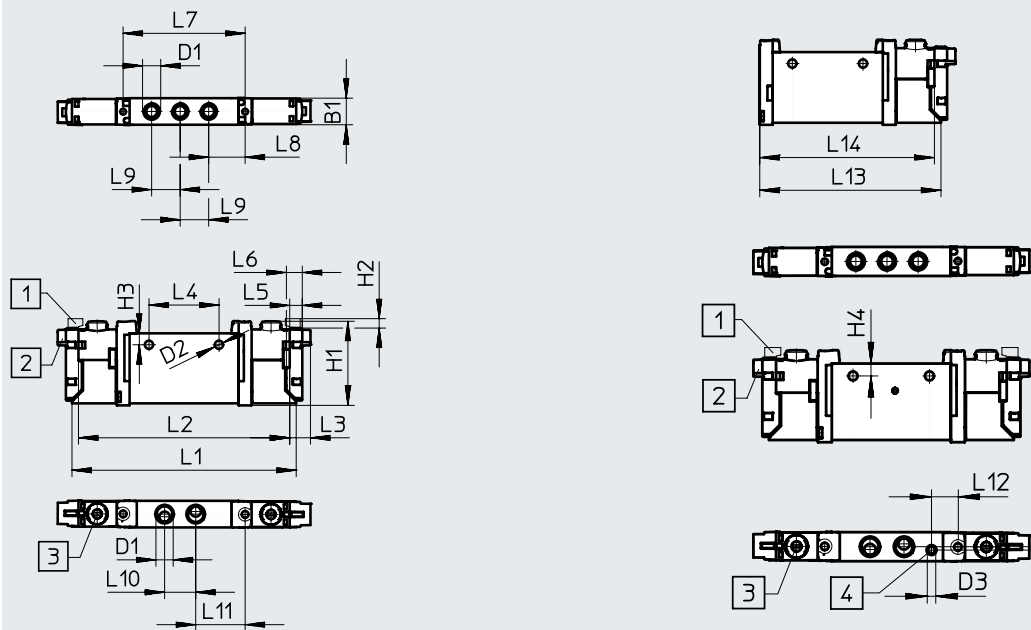

**Note**  
 More dimensions  
 E-boxes  
 → Page 112

[1] Vertical electrical connection      [2] Horizontal electrical connection      [3] Manual override      [4] Port for external pilot air supply

Type	B1	B2	D1	D2	D3	H1	H2	H3	L1	L2	L3	L4
VUVG-L-10 ....M7...	10.2	-	M7	3.2	M3	32.5	3.6	4.4	86.5	81.5	8	27
VUVG-S-10 ....M7...												

Type	L5	L6	L7	L8	L9	L10	L11	L12	L13	L14
VUVG-L-10 ....M7...	4.85	6.15	47	14	11	12	19	-	69.2	66.7
VUVG-S-10 ....M7...										

## Ordering data

## ★ Core Range

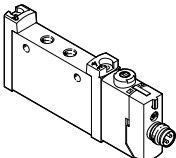
Ordering data	Description	Part no.	Type
<b>In-line valve M7, with E-box R8</b>			
	<b>5/3-way valve</b>		
	Internal pilot air supply	Mid-position closed, mechanical spring return	★ 574223

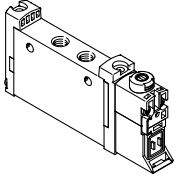
Ordering data	Description	Part no.	Type	
<b>In-line valve M7, without E-box</b>				
	<b>2x 3/2-way valve</b>			
	Internal pilot air supply	Normally closed, pneumatic spring return	566471	VUVG-L10-T32C-AT-M7-1P3
		Normally open, pneumatic spring return	566472	VUVG-L10-T32U-AT-M7-1P3
		1x normally open, 1x normally closed, pneumatic spring return	566473	VUVG-L10-T32H-AT-M7-1P3
		Normally closed, mechanical spring return	574356	VUVG-L10-T32C-MT-M7-1P3
		Normally open, mechanical spring return	574357	VUVG-L10-T32U-MT-M7-1P3
		1x normally open, 1x normally closed, mechanical spring return	574358	VUVG-L10-T32H-MT-M7-1P3
	External pilot air supply	Normally closed, pneumatic spring return	566479	VUVG-L10-T32C-AZT-M7-1P3
		Normally open, pneumatic spring return	566480	VUVG-L10-T32U-AZT-M7-1P3
		1x normally open, 1x normally closed, pneumatic spring return	566481	VUVG-L10-T32H-AZT-M7-1P3
		Normally closed, mechanical spring return	574360	VUVG-L10-T32C-MZT-M7-1P3
		Normally open, mechanical spring return	574361	VUVG-L10-T32U-MZT-M7-1P3
		Normally closed, mechanical spring return	574362	VUVG-L10-T32H-MZT-M7-1P3

Ordering data

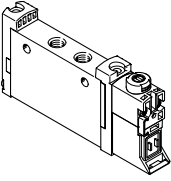
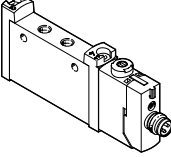
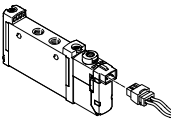
Ordering data	Description	Part no.	Type	
<b>In-line valve M7, without E-box</b>				
	<b>5/2-way valve, single solenoid</b>			
	Internal pilot air supply	Mechanical spring return	574359	VUVG-L10-M52-MT-M7-1P3
		Pneumatic/mechanical spring return	566474	VUVG-L10-M52-RT-M7-1P3
	External pilot air supply	Mechanical spring return	574363	VUVG-L10-M52-MZT-M7-1P3
		Pneumatic/mechanical spring return	566482	VUVG-L10-M52-RZT-M7-1P3
	<b>5/2-way valve, double solenoid</b>			
	Internal pilot air supply		566475	VUVG-L10-B52-T-M7-1P3
	External pilot air supply		566483	VUVG-L10-B52-ZT-M7-1P3
	<b>5/3-way valve</b>			
	Internal pilot air supply	Mid-position closed, mechanical spring return	566476	VUVG-L10-P53C-T-M7-1P3
		Mid-position exhausted, mechanical spring return	566477	VUVG-L10-P53E-T-M7-1P3
		Mid-position pressurised, mechanical spring return	566478	VUVG-L10-P53U-T-M7-1P3
External pilot air supply	Mid-position closed, mechanical spring return	566484	VUVG-L10-P53C-ZT-M7-1P3	
	Mid-position exhausted, mechanical spring return	566485	VUVG-L10-P53E-ZT-M7-1P3	
	Mid-position pressurised, mechanical spring return	566486	VUVG-L10-P53U-ZT-M7-1P3	
<b>In-line valve M7, with E-box R8</b>				
	<b>2x 3/2-way valve</b>			
	Internal pilot air supply	Normally closed, pneumatic spring return	574218	VUVG-L10-T32C-AT-M7-1R8L
		Normally open, pneumatic spring return	574219	VUVG-L10-T32U-AT-M7-1R8L
		1x normally open, 1x normally closed, pneumatic spring return	574220	VUVG-L10-T32H-AT-M7-1R8L
		Normally closed, mechanical spring return	8031480	VUVG-L10-T32C-MT-M7-1R8L
		Normally open, mechanical spring return	8031481	VUVG-L10-T32U-MT-M7-1R8L
		1x normally open, 1x normally closed, mechanical spring return	8031482	VUVG-L10-T32H-MT-M7-1R8L
	<b>5/2-way valve, single solenoid</b>			
	Internal pilot air supply	Pneumatic/mechanical spring return	574221	VUVG-L10-M52-RT-M7-1R8L
		Mechanical spring return	8031485	VUVG-L10-M52-MT-M7-1R8L
	<b>5/2-way valve, double solenoid</b>			
	Internal pilot air supply		574222	VUVG-L10-B52-T-M7-1R8L
	<b>5/3-way valve</b>			
	Internal pilot air supply	Mid-position exhausted, mechanical spring return	574225	VUVG-L10-P53E-T-M7-1R8L
		Mid-position pressurised, mechanical spring return	574224	VUVG-L10-P53U-T-M7-1R8L
<b>In-line valve M7, with E-box H2</b>				
	<b>5/2-way valve, single solenoid</b>			
	Internal pilot air supply	Pneumatic/mechanical spring return	577333	VUVG-L10-M52-RT-M7-1H2L-W1
		Mechanical spring return	578163	VUVG-L10-M52-MT-M7-1H2L-W1
	<b>5/2-way valve, double solenoid</b>			
Internal pilot air supply		577332	VUVG-L10-B52-T-M7-1H2L-W1	

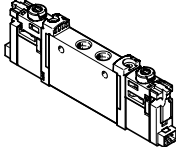

## Ordering data

Ordering data	Description	Part no.	Type	
<b>In-line valve M7, suited for battery manufacturing</b>				
	<b>2x 3/2-way valve</b>			
	Internal pilot air supply	Normally closed, mechanical spring return	8164343	VUVG-L10-T32C-MT-M7-1H2L-F1A
		Normally open, pneumatic spring return	8164344	VUVG-L10-T32U-AT-M7-1H2L-F1A
		Normally open, mechanical spring return	8164345	VUVG-L10-T32U-MT-M7-1H2L-F1A
		1x normally open, 1x normally closed, pneumatic spring return	8154346	VUVG-L10-T32H-AT-M7-1H2L-F1A
		1x normally open, 1x normally closed, mechanical spring return	8164347	VUVG-L10-T32H-MT-M7-1H2L-F1A
	External pilot air supply	Normally closed, pneumatic spring return	8164352	VUVG-L10-T32C-AZT-M7-1H2L-F1A
		Normally closed, mechanical spring return	8164353	VUVG-L10-T32C-MZT-M7-1H2L-F1A
		Normally open, pneumatic spring return	8164354	VUVG-L10-T32U-AZT-M7-1H2L-F1A
		Normally open, mechanical spring return	8164355	VUVG-L10-T32U-MZT-M7-1H2L-F1A
		1x normally open, 1x normally closed, pneumatic spring return	8164356	VUVG-L10-T32H-AZT-M7-1H2L-F1A
	1x normally open, 1x normally closed, mechanical spring return	8164357	VUVG-L10-T32H-MZT-M7-1H2L-F1A	
	<b>5/2-way valve, single solenoid</b>			
	Internal pilot air supply	Mechanical spring return	8164348	VUVG-L10-M52-MT-M7-1H2L-F1A
	External pilot air supply	Pneumatic/mechanical spring return	8164358	VUVG-L10-M52-RZT-M7-1H2L-F1A
		Mechanical spring return	8164359	VUVG-L10-M52-MZT-M7-1H2L-F1A
	<b>5/2-way valve, double solenoid</b>			
	External pilot air supply		8164360	VUVG-L10-B52-ZT-M7-1H2L-F1A
<b>5/3-way valve</b>				
Internal pilot air supply	Mid-position closed	8164349	VUVG-L10-P53C-T-M7-1H2L-F1A	
	Mid-position exhausted	8164350	VUVG-L10-P53E-T-M7-1H2L-F1A	
	Mid-position pressurised	8164351	VUVG-L10-P53U-T-M7-1H2L-F1A	
External pilot air supply	Mid-position closed	8164361	VUVG-L10-P53C-ZT-M7-1H2L-F1A	
	Mid-position exhausted	8164362	VUVG-L10-P53E-ZT-M7-1H2L-F1A	
	Mid-position pressurised	8164363	VUVG-L10-P53U-ZT-M7-1H2L-F1A	

## Manifold assembly

### In-line valves for manifold assembly



### Dimensions

Download CAD data → [www.festo.com](http://www.festo.com)

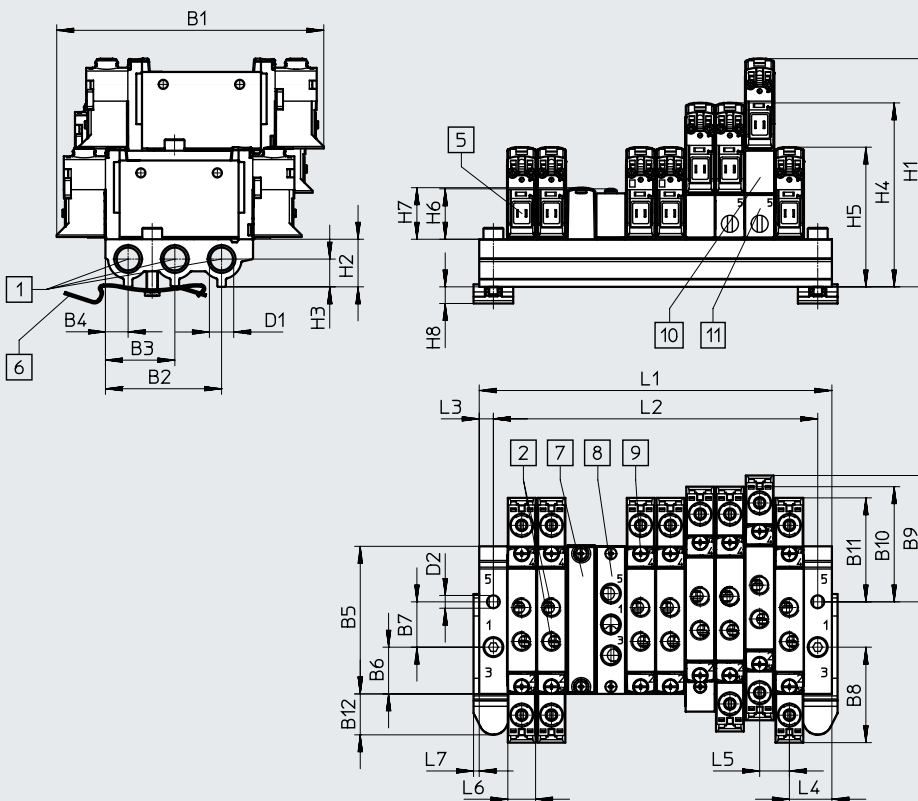

- - **Note**

More dimensions

E-boxes

→ Page 112

- |   |  |   |                                      |
|---|--|---|--------------------------------------|
| [1] Ports 1, 3 and 5: G1/8                            | [6] H-rail mounting (two M4x20 screws are required for mounting) | [8] Supply plate  | [10] Vertical pressure supply plate  |
| [2] Ports 1, 2, 3, 4 and 5 on the valve: M7 or M5     | [7] Cover plate  | [9] Valves/cover plate mounting on manifold rail: M2 thread | [11] Vertical pressure exhaust plate |
| [5] Electrical connection for E-boxes and accessories |  |   |                                      |

Type	B1	B2	B3	B4	B5	B6	B7	B8	B9	B10	B11	B12	D1	D2
VABML-L1-10S-G18	94.3	41	24.5	8	52.1	16.5	16	33.7	44.6	40.7	36.7	14.4	G1/8	4.5

  

Type	D5	H1	H2	H3	H4	H5	H6	H7	H8	L3	L4	L5	L6	L7
VABML-L1-10S-G18	8	80.6	16.8	9.8	64.9	49.3	17.8	18	5.9	5	15	10.5	10.3	2

Valve positions	2	3	4	5	6	7	8	9	10	12	14	16	22
L1	40.5	51	61.5	72	82.5	93	103.5	114	124.5	145.5	166.5	187.5	250.5
L2	30.5	41	51.5	62	72.5	83	93.5	104	114.5	135.5	156.5	177.5	240.5
Weight of VABM [g]	63	78	93	108	123	138	153	168	183	213	243	273	363

## Ordering data

Technical data – Manifold rails								
	Connection	KBK	Material <sup>2)</sup>	Operating pressure		Max. tightening torque for assembly [Nm]		
	1, 3, 5			[MPa]	[bar]	Valve	H-rail	Wall
	G1/8	2 <sup>1)</sup>	Wrought aluminium alloy	0.15 ... 0.8	1.5 ... 8	0.45	1.5	3

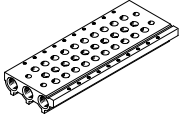

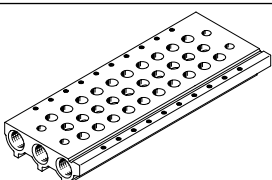

1) Corrosion resistance class CRC 2 to Festo standard FN 940070

Moderate corrosion stress. Indoor applications in which condensation can occur. External visible parts with primarily decorative surface requirements which are in direct contact with a normal industrial environment.

2) Information on materials: RoHS-compliant.

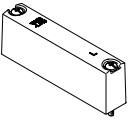
Ordering data – Manifold rail				
	Description		Part no.	Type
<b>Manifold rail for in-line valve (manifold assembly)</b>				
	For size M5/M7	2 valve positions	★ 566558	VABM-L1-10S-G18-2
		3 valve positions	★ 566559	VABM-L1-10S-G18-3
		4 valve positions	★ 566560	VABM-L1-10S-G18-4
		5 valve positions	566561	VABM-L1-10S-G18-5
		6 valve positions	★ 566562	VABM-L1-10S-G18-6
		7 valve positions	566563	VABM-L1-10S-G18-7
		8 valve positions	★ 566564	VABM-L1-10S-G18-8
		9 valve positions	566565	VABM-L1-10S-G18-9
		10 valve positions	★ 566566	VABM-L1-10S-G18-10
		12 valve positions	566567	VABM-L1-10S-G18-12
		14 valve positions	566568	VABM-L1-10S-G18-14
		16 valve positions	566569	VABM-L1-10S-G18-16

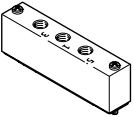
## Ordering data

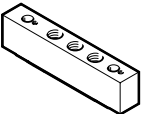
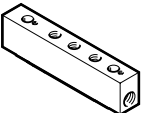
Ordering data – Accessories		Description	Part no.	Type	
<b>Cover plate</b> <span style="float: right;">Datasheets → Internet: vabb</span>					
	For valve position on manifold rail, including screws and seal	–	★ 566462	VABB-L1-10-S	
		Suitable for battery production	8168538	VABB-L1-10-F1A	
<b>Separator</b> <span style="float: right;">Datasheets → Internet: vabd</span>					
	For creating pressure zones		569995	VABD-8-B	
<b>Supply plate</b> <span style="float: right;">Datasheets → Internet: vabf</span>					
	For valve position (in-line valves M5) on manifold rail, including screws and seal	–	569991	VABF-L1-10-P3A4-M5	
		Suitable for battery production	8163542	VABF-L1-10-P3A4-M5-F1A	
	For valve position (in-line valves M7) on manifold rail, including screws and seal	–	569992	VABF-L1-10-P3A4-M7	
		Suitable for battery production	8163543	VABF-L1-10-P3A4-M7-F1A	
<b>Seals</b> <span style="float: right;">Datasheets → Internet: vabd</span>					
	<b>In-line valves VUVG-LK</b>				
	For in-line valves M5	Delivery quantity: 10 sets (each with 2 screws and 1 seal)	–	★ 8043718	VABD-L1-10XK-S-M5-S
			Suitable for battery production	8168885	VABD-L1-10XK-S-M5-F1A
	For in-line valves M7	2 screws and 1 seal)	–	★ 8043719	VABD-L1-10XK-S-M7-S
			Suitable for battery production	8168884	VABD-L1-10XK-S-M7-F1A
	<b>In-line valves VUVG-L</b>				
For in-line valves M5	Delivery quantity: 10 sets (each with 2 screws and 1 seal)	–	★ 566672	VABD-L1-10X-S-M5	
		Suitable for battery production	8168587	VABD-L1-10X-S-M5-F1A	
For in-line valves M7	2 screws and 1 seal)	–	★ 566673	VABD-L1-10X-S-M7	
		Suitable for battery production	8168588	VABD-L1-10X-S-M7-F1A	
<b>Vertical pressure supply plate</b>					
	Pneumatic connection 1: M7	Terminal code CP	574592	VABF-L1-P3A3-M7	
<b>Vertical pressure exhaust plate</b>					
	Pneumatic connection 3, 5: M7	Terminal code CR	574594	VABF-L1-P7A13-M7	

## Datasheet

### Function

2x 3/2C

5/2-way, single solenoid

5/2-way, double solenoid valve

Circuit symbols → page 14

-  - Size 14 mm

-  - Flow rate  
570 ... 660 l/min

-  - Voltage  
24 V DC



General technical data VUVG-LK			
Valve function	T32-A	M52-A	B52
Normal position	C <sup>1)</sup>	-	-
Stable position	Monostable		Bistable
Pneumatic spring return	Yes	Yes	-
Design	Piston spool		
Sealing principle	Soft		
Actuation type	Electrical		
Type of control	Piloted		
Pilot air supply	Internal		
Exhaust function	Can be throttled		
Manual override	Non-detenting, detenting		
Type of mounting	Optionally via through-holes <sup>2)</sup> or on manifold rail		
Mounting position	Any		
Standard nominal flow rate	[l/min]	570	660
Switching time on/off	[ms]	13/20	14/24
Changeover time	[ms]	-	8
Size	[mm]	14	
Connection	2, 4	G1/8	
Product weight	[g]	75	85
Corrosion resistance class CRC <sup>3)</sup>	0		
Certificate-issuing authority	UL MH19482		
Certification	c UL us - Recognized (OL)		

1) C = normally closed

2) If several valves are to be screwed together via the through-holes to form a block, a minimum distance of 0.3 mm must be ensured by inserting spacers

3) More information: [www.festo.com/x/topic/kbk](http://www.festo.com/x/topic/kbk)

Safety characteristics		
Max. positive test pulse with 0 signal	[μs]	1600
Max. negative test pulse with 1 signal	[μs]	3000
Shock resistance	Shock test with severity level 1 to FN 942017-5 and EN 60068-2-27	
Vibration resistance	Transport application test with severity level 1 to FN 942017-4 and EN 60068-2-6	

## Datasheet

Operating and environmental conditions			
Valve function		T32-A <sup>1)</sup>	M52-A <sup>1)</sup>   B52
Operating medium	Compressed air to ISO 8573-1:2010 [7:4:4]		
Note on the operating/pilot medium	Lubricated operation possible (in which case lubricated operation will always be required)		
Operating pressure	[MPa]	0.15 ... 0.7	0.25 ... 0.7   0.15 ... 0.7
	[bar]	1.5 ... 7	2.5 ... 7   1.5 ... 7
Ambient temperature	[°C]	-5 ... +50	
Temperature of medium	[°C]	-5 ... +50	

1) Pneumatic spring

Electrical data	
Electrical connection	Via E-box → page 110
Operating voltage	[V DC] 5, 12, 24 ±10%
Power	[W] 1, reduced to 0.35 with holding current reduction
Duty cycle	[%] 100
Degree of protection to EN 60529	IP40 (with plug socket), IP65 (with M8)

Information on materials	
Housing	Wrought aluminium alloy
Seals	HNBR, NBR
Note on materials	RoHS-compliant
PWIS conformity	VDMA24364 zone III

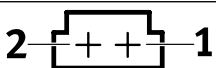
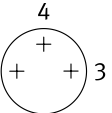
Pin allocation for E-box			
	Pin		Description
<b>Rectangular plug, connection pattern H</b>			
	1	+ or -	Protective circuit without holding current reduction
	2	+ or -	
<b>Round plug, M8, 3-pin</b>			
	1	Not used	Protective circuit without holding current reduction
	3	+ or -	
	4	+ or -	

### Protective circuit without holding current reduction

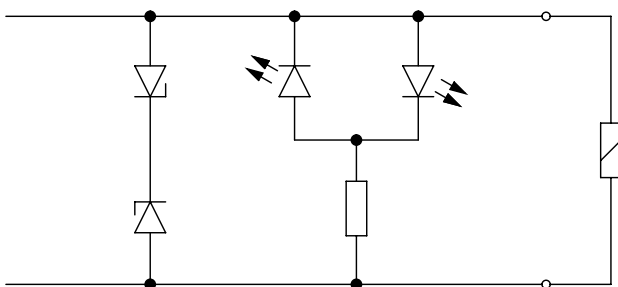

The solenoid coils have a protective circuit to arrest sparks and protect against polarity reversal.

Datasheet

Dimensions

Download CAD data → [www.festo.com](http://www.festo.com)

2x 3/2-way, 5/2-way valve, double solenoid

5/2-way valve, single solenoid

 **Note**  
More dimensions  
E-boxes  
→ Page 112

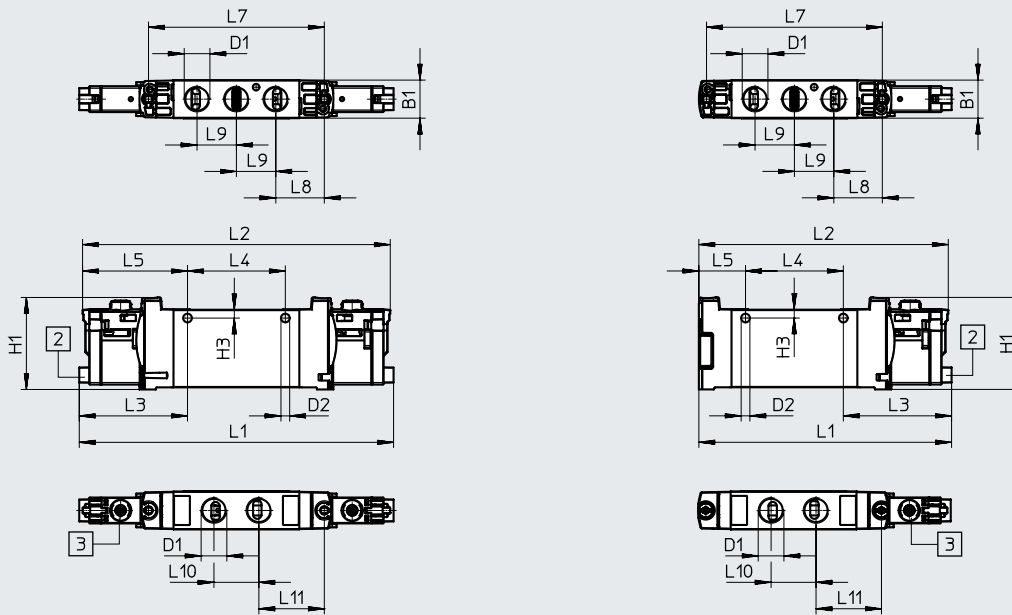

[2] Horizontal electrical connection    [3] Manual override

Type	B1	D1	D2	H1	H3	L1	L2	L3	L4	L5
VUVG-LK14-T32C...-G18...	14.4	G1/8	3.3	34.8	3.2	118.9	116.4	41	37	39.7
VUVG-LK14-B52...-G18...						95.6	94.4			17.7
VUVG-LK14-M52...-G18...										

Type	L7	L8	L9	L10	L11
VUVG-LK14-T32C...-G18...	66.5	18.4	14.9	17	24.8
VUVG-LK14-B52...-G18...					
VUVG-LK14-M52...-G18...					

## Ordering data

## ★ Core Range

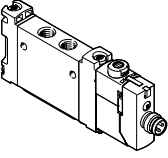
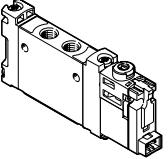
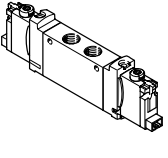
Ordering data		Description	Part no.	Type
<b>In-line valve G1/8, with E-box R8</b>				
	<b>2x 3/2-way valve</b>			
	Internal pilot air supply	Normally closed, pneumatic spring return	★ 8042566	VUVG-LK14-T32C-AT-G18-1R8L-S
	<b>5/2-way valve, single solenoid</b>			
	Internal pilot air supply	Pneumatic spring return	★ 8042567	VUVG-LK14-M52-AT-G18-1R8L-S
	<b>5/2-way valve, double solenoid</b>			
	Internal pilot air supply		★ 8042568	VUVG-LK14-B52-T-G18-1R8L-S
<b>In-line valve G1/8, with E-box H2</b>				
	<b>2x 3/2-way valve</b>			
	Internal pilot air supply	Normally closed, pneumatic spring return	★ 8042562	VUVG-LK14-T32C-AT-G18-1H2L-S
	<b>5/2-way valve, single solenoid</b>			
	Internal pilot air supply	Pneumatic spring return	★ 8042563	VUVG-LK14-M52-AT-G18-1H2L-S
	<b>5/2-way valve, double solenoid</b>			
	Internal pilot air supply		★ 8042564	VUVG-LK14-B52-T-G18-1H2L-S
<b>In-line valve G1/8, for battery manufacturing</b>				
	<b>2x 3/2-way valve</b>			
	Internal pilot air supply	Normally closed, pneumatic spring return	8173205	VUVG-LK14-T32C-AT-G18-1H2L-F1A
	<b>5/2-way valve, single solenoid</b>			
	Internal pilot air supply	Pneumatic spring return	8173206	VUVG-LK14-M52-AT-G18-1H2L-F1A
	<b>5/2-way valve, double solenoid</b>			
	Internal pilot air supply		8173207	VUVG-LK14-B52-T-G18-1H2L-F1A







## Datasheet

### Function

2x 3/2C, 2x 3/2U, 2x 3/2H  
 5/2-way, single solenoid  
 5/2-way, double solenoid valve  
 5/3C, 5/3U, 5/3E

Circuit symbols → page 14

-  - Size 14 mm
-  - Flow rate  
480 ... 780 l/min
-  - Voltage VUVG-...  
5, 12 and 24 V DC  
24, 110 and 230 V AC
-  - Voltage VUVG-...-P1  
12 and 24 V DC  
24, 110 and 230 V AC



General technical data VUVG-L														
Valve function	T32-A			T32-M			M52-A	B52	M52-M	P53				
Normal position	C <sup>1)</sup>	U <sup>2)</sup>	H <sup>4)</sup>	C <sup>1)</sup>	U <sup>2)</sup>	H <sup>4)</sup>	–	–	–	C <sup>1)</sup>	U <sup>2)</sup>	E <sup>3)</sup>		
Stable position	Monostable						Bistable		Monostable					
Pneumatic spring return	Yes			No			Yes	–	No	–				
Mechanical spring return	No			Yes			No	–	Yes	Yes				
Vacuum operation at port 1	No			Only with external pilot air supply										
Size	[mm]			14										
Design	Piston spool													
Sealing principle	Soft													
Actuation type	Electrical													
Type of control	Piloted													
Pilot air supply	Internal or external													
Exhaust function	Can be throttled													
Manual override	VUVG-...			Choice of non-detenting, covered, non-detenting/detenting or detenting										
	VUVG-...-P1			Non-detenting, non-detenting/detenting										
Type of mounting	Optionally via through-holes <sup>5)</sup> or on manifold rail													
Mounting position	Any													
Nominal width	[mm]			4.6			4.3	5.6	5.6	5.6	5.6			
Standard nominal flow rate	[l/min]			560	600	590	550	500	500	780	780	780	650	560
Flow rate on manifold rail	[l/min]			560	580		520	480	480	680	700	700	620	560
<b>Switching time</b>														
VUVG-...	On/off	[ms]		9/25			12/18			14/22		–	13/37	12/40
	Changeover	[ms]		–			–			8		–	20	
VUVG-...-P1	On/off	[ms]		11/18			14/13			16/16		–	12/26	14/24
	Changeover	[ms]		–			–			12		–	19	
Pneumatic connection	1, 2, 3, 4, 5			G1/8										
	12/14			M5										
Certificate-issuing authority	VUVG-...-P1			UL MH19482										
Certification	VUVG-...			RCM mark										
	VUVG-...			c UL us - Recognized (OL)										
	VUVG-...-P1													

1) C=Normally closed/mid-position closed

2) U=Normally open/mid-position pressurised

3) E=Mid-position exhausted

4) H=2x 3/2-way valve in one housing with 1x normally closed and 1x normally open

5) If several valves are to be screwed together via the through-holes to form a block, a minimum distance of 0.3 mm must be ensured by inserting spacers.

## Datasheet

General technical data VUVG-L			T32-A	T32-M	M52-A	B52	M52-M	P53
Valve function								
Product weight	VUVG-... [g]		89	80	78	89	70	89
	VUVG-...-P1 [g]		65	56	66	65	58	65
Certification VUVG-...			c UL us - Recognized (OL) RCM					
<b>CE marking (see declaration of conformity)<sup>1)</sup></b>								
	VUVG-...		To EU EMC Directive					
	VUVG-...-P1		To EU Low Voltage Directive					
Corrosion resistance class CRC <sup>2)</sup>			2					
Certificate- issuing authority	VUVG-...-F1A		UL MH19482					

1) For information about the area of use, see the EC declaration of conformity at: [www.festo.com/catalogue/...](http://www.festo.com/catalogue/...) → Support/Downloads.

If the devices are subject to usage restrictions in residential, commercial or light-industrial environments, further measures for the reduction of the emitted interference may be necessary.

2) More information: [www.festo.com/x/topic/kbk](http://www.festo.com/x/topic/kbk)

Operating and environmental conditions			T32-A <sup>1)</sup>	T32-M <sup>2)</sup>	M52-A <sup>1)</sup>	B52	M52-M <sup>2)</sup>	P53	
Valve function									
Operating medium			Compressed air to ISO 8573-1:2010 [7:4:4]						
Operating pressure	Internal	[MPa]	0.15 ... 0.8	0.3 ... 0.8	0.25 ... 0.8	0.15 ... 0.8	0.3 ... 0.8	0.3 ... 0.8	
		[bar]	1.5 ... 8	3 ... 8	2.5 ... 8	1.5 ... 8	3 ... 8	3 ... 8	
	External VUVG-...	[MPa]	0.15 ... 1	-0.09 ... 1				-0.09 ... 0.8	-0.09 ... 1
		[bar]	1.5 ... 10	-0.9 ... 10				-0.9 ... 8	-0.9 ... 10
Pilot pressure <sup>3)</sup>	Internal	[MPa]	0.15 ... 0.8	0.35 ... 0.8	0.25 ... 0.8	0.15 ... 0.8	0.3 ... 0.8	0.3 ... 0.8	
		[bar]	1.5 ... 8	3.5 ... 8	2.5 ... 8	1.5 ... 8	3 ... 8	3 ... 8	
	External VUVG-...	[MPa]	0.15 ... 0.8	0.3 ... 0.8	0.25 ... 0.8	0.15 ... 0.8	0.3 ... 0.8	0.3 ... 0.8	
		[bar]	1.5 ... 8	3 ... 8	2.5 ... 8	1.5 ... 8	3 ... 8	3 ... 8	
Ambient temperature	VUVG-...	[°C]	-5 ... +50, with holding current reduction -5 ... +60						
	VUVG-...-P1	[°C]	-5 ... +50, for mounting on manifold rail -5 ... +60						
Temperature of medium	VUVG-...	[°C]	-5 ... +50, with holding current reduction -5 ... +60						
	VUVG-...-P1	[°C]	-5 ... +50, for mounting on manifold rail -5 ... +60						

1) Pneumatic spring

2) Mechanical spring

3) Minimum pilot pressure 50% of operating pressure

Electrical data			
Electrical connection	VUVG-...		Via E-box → page 110
	VUVG-...-P1		Via electric pilot valve
Pilot interface	VUVG-...-P1		To ISO 15218
Operating voltage	VUVG-...	[V DC]	5, 12 and 24 ±10%
		[V DC]	12 and 24 ±10%
		[V AC]	24, 110 and 230 ±10%
Power	VUVG-...	[W]	1, reduced to 0.35 with holding current reduction
	VUVG-...-P1	[W]	1.3
Duty cycle		[%]	100
Degree of protection to EN 60529	VUVG-...		IP40 (with plug socket), IP65 (with M8)
	VUVG-...-P1		IP65, with electric pilot valve and plug socket

Safety characteristics		
Max. positive test pulse with 0 signal	[µs]	700
Max. negative test pulse with 1 signal	[µs]	900
Shock resistance		Shock test with severity level 2 to FN 942017-5 and EN 60068-2-27
Vibration resistance		Transport application test with severity level 2 to FN 942017-4 and EN 60068-2-6

Information on materials	
Housing	Wrought aluminium alloy
Seals	HNBR, NBR
Note on materials	RoHS-compliant
PWIS conformity	VDMA24364-B1/B2-L

Datasheet

Dimensions VUVG

2x 3/2-way, 5/2-way and 5/3-way valve

Download CAD data → [www.festo.com](http://www.festo.com)

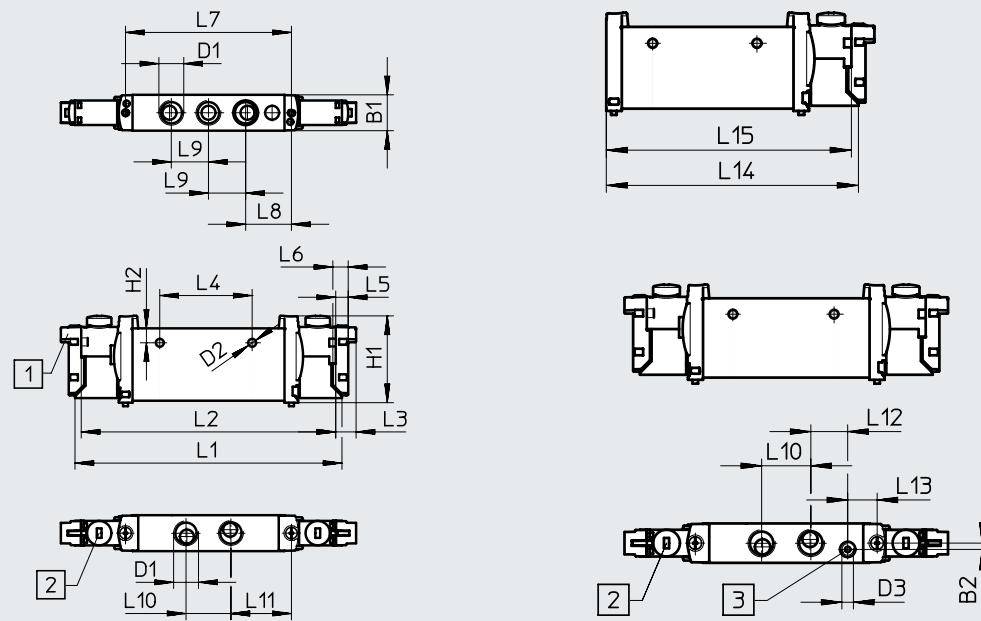

**Note**  
 More dimensions  
 E-boxes  
 → Page 112

[1] Horizontal electrical connection    [2] Manual override    [3] Port for external pilot air supply

Type	B1	B2	D1	D2 ∅	D3	H1	H2	L1	L2	L3	L4
VUVG-L14 -...-G18...	14.4	2.3	G1/8	3.2	M5	34.8	5.8	107	102	8	37
VUVG-S14 -...-G18...											

Type	L5	L6	L7	L8	L9	L10	L11	L12	L13	L14	L15
VUVG-L14 -...-G18...	4.85	6.2	66.5	18.35	14.9	18	24.3	13.5	10.8	89.4	87
VUVG-S14 -...-G18...											

## Datasheet

### Dimensions VUVG-...-P1

Download CAD data → [www.festo.com](http://www.festo.com)

2x 3/2-way, 5/2-way and 5/3-way valve

5/2-way valve, single solenoid

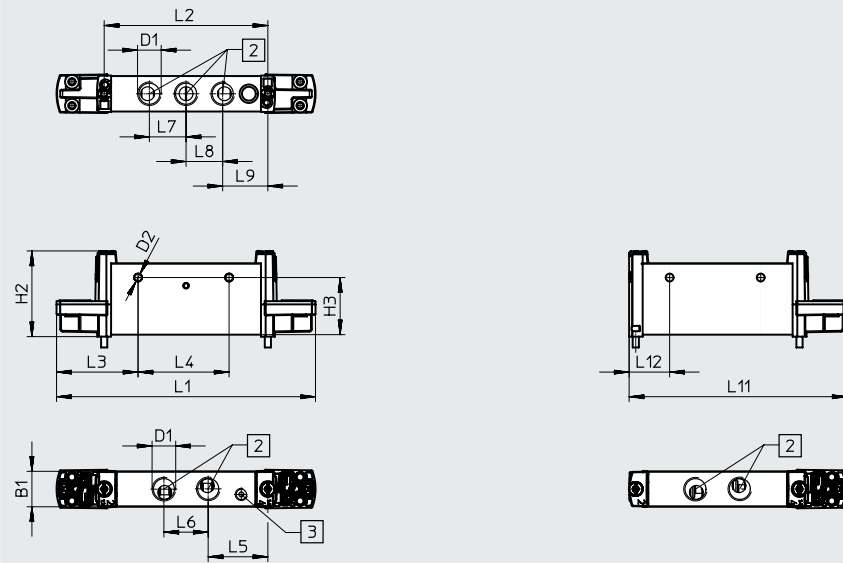

[2] Connections 1...5

[3] Port for external pilot air supply

Type	B1	D1	D2 Ø	H2	H3	L1	L2	L3	L4	L5	L6	L7	L8	L9	L11	L12
VUVG-L14 -...-P1	14.4	G1/8	3.2	34.8	23.2	105.2	66.5	33.1	37	24.3	18	14.9	14.9	18.4	88.6	16.5

## Ordering data

## ★ Core Range

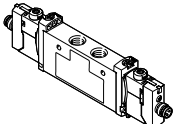
Ordering data		Description	Part no.	Type
<b>In-line valve G1/8, with E-box R8</b>				
	<b>5/3-way valve</b>			
	Internal pilot air supply	Mid-position closed, mechanical spring return	★ 574231	VUVG-L14-P53C-T-G18-1R8L

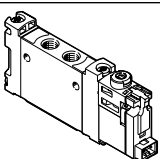
Ordering data		Description	Part no.	Type	
<b>In-line valve G1/8, without E-box</b>					
	<b>2x 3/2-way valve</b>				
	Internal pilot air supply	Normally closed, pneumatic spring return	566496	VUVG-L14-T32-AT-G18-1P3	
		Normally open, pneumatic spring return	566497	VUVG-L14-32U-AT-G18-1P3	
		1x normally open, 1x normally closed, pneumatic spring return	566498	VUVG-L14-T32H-AT-G18-1P3	
		Normally closed, mechanical spring return	574368	VUVG-L14-T32C-MT-G18-1P3	
		Normally open, mechanical spring return	574369	VUVG-L14-T32U-MT-G18-1P3	
		1x normally open, 1x normally closed, mechanical spring return	574370	VUVG-L14-T32H-MT-G18-1P3	
	External pilot air supply	Normally closed, pneumatic spring return	566505	VUVG-L14-T32C-AZT-G18-1P3	
		Normally open, pneumatic spring return	566506	VUVG-L14-T32U-AZT-G18-1P3	
		1x normally open, 1x normally closed, pneumatic spring return	566507	VUVG-L14-T32H-AZTG18-1P3	
		Normally closed, mechanical spring return	574372	VUVG-L14-T32C-MZT-G18-1P3	
		Normally open, mechanical spring return	574373	VUVG-L14-T32U-MZT-G18-1P3	
		Normally closed, mechanical spring return	574374	VUVG-L14-T32H-MZT-G18-1P3	
	<b>5/2-way valve, single solenoid</b>				
	Internal pilot air supply	Pneumatic spring return	566499	VUVG-L14-M52-AT-G18-1P3	
		Mechanical spring return	574371	VUVG-L14-M52-MT-G18-1P3	
	External pilot air supply	Pneumatic spring return	566508	VUVG-L14-M52-AZT-G18-1P3	
		Mechanical spring return	574375	VUVG-L14-M52-MZT-G18-1P3	
	<b>5/2-way valve, double solenoid</b>				
	Internal pilot air supply		566500	VUVG-L14-B52-T-G18-1P3	
External pilot air supply		566509	VUVG-L14-B52-ZT-G18-1P3		

## Ordering data

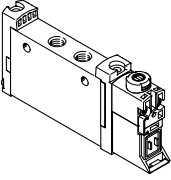
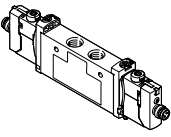
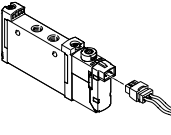
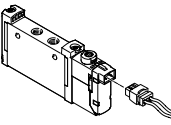
Ordering data		Description	Part no.	Type	
<b>In-line valve G1/8, without E-box</b>					
	<b>5/3-way valve</b>				
	Internal pilot air supply	Mid-position closed, mechanical spring return	566501	VUVG-L14-P53C-T-G18-1P3	
		Mid-position exhausted, mechanical spring return	566502	VUVG-L14-P53E-T-G18-1P3	
		Mid-position pressurised, mechanical spring return	566503	VUVG-L14-P53U-T-G18-1P3	
	External pilot air supply	Mid-position closed, mechanical spring return	566510	VUVG-L14-P53C-ZT-G18-1P3	
		Mid-position exhausted, mechanical spring return	566511	VUVG-L14-P53E-ZT-G18-1P3	
Mid-position pressurised, mechanical spring return		566512	VUVG-L14-P53U-ZT-G18-1P3		
<b>In-line valve G1/8, with E-box R8</b>					
	<b>2x 3/2-way valve</b>				
	Internal pilot air supply	Normally closed, pneumatic spring return	574226	VUVG-L14-T32C-AT-G18-1R8L	
		Normally open, pneumatic spring return	574227	VUVG-L14-T32U-AT-G18-1R8L	
		1x normally open, 1x normally closed, pneumatic spring return	574228	VUVG-L14-T32H-AT-G18-1R8L	
		Normally closed, mechanical spring return	8031504	VUVG-L14-T32C-MT-G18-1R8L	
		Normally open, mechanical spring return	8031505	VUVG-L14-T32U-MT-G18-1R8L	
		1x normally open, 1x normally closed, mechanical spring return	8031506	VUVG-L14-T32H-MT-G18-1R8L	
	<b>5/2-way valve, single solenoid</b>				
	Internal pilot air supply	Pneumatic spring return	574229	VUVG-L14-M52-AT-G18-1R8L	
		Mechanical spring return	8031508	VUVG-L14-M52-MT-G18-1R8L	
	<b>5/2-way valve, double solenoid</b>				
	Internal pilot air supply		574230	VUVG-L14-B52-T-G18-1R8L	
	<b>5/3-way valve</b>				
	Internal pilot air supply	Mid-position exhausted, mechanical spring return	574233	VUVG-L14-P53E-T-G18-1R8L	
		Mid-position pressurised, mechanical spring return	574232	VUVG-L14-P53U-T-G18-1R8L	
<b>In-line valve G1/8, with E-box H2</b>					
	<b>2x 3/2-way valve</b>				
	Internal pilot air supply	Normally closed, pneumatic spring return	577321	VUVG-L14-T32C-AT-G18-1H2L-W1	
	<b>5/2-way valve, single solenoid</b>				
	Internal pilot air supply	Pneumatic spring return	576256	VUVG-L14-M52-AT-G18-1H2L-W1	
		Mechanical spring return	578164	VUVG-L14-M52-MT-G18-1H2L-W1	
<b>5/2-way valve, double solenoid</b>					
Internal pilot air supply		577319	VUVG-L14-B52-T-G18-1H2L-W1		
<b>Semi in-line valve G1/8, with E-box H2</b>					
<b>5/2-way valve, single solenoid</b>					
	Internal pilot air supply	Pneumatic spring return	577325	VUVG-S14-M52-AT-G18-1H2L-W1	

## Ordering data

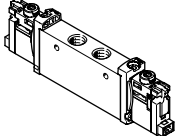
Ordering data	Description	Part no.	Type	
<b>In-line valve G1/8, suited for battery manufacturing</b>				
	<b>2x 3/2-way valve</b>			
	Internal pilot air supply	Normally closed, mechanical spring return	8164552	VUVG-L14-T32C-MT-G18-1H2L-F1A
		Normally open, pneumatic spring return	8164553	VUVG-L14-T32U-AT-G18-1H2L-F1A
		Normally open, mechanical spring return	8164554	VUVG-L14-T32U-MT-G18-1H2L-F1A
		1x normally open, 1x normally closed, pneumatic spring return	8164555	VUVG-L14-T32H-AT-G18-1H2L-F1A
		1x normally open, 1x normally closed, mechanical spring return	8164556	VUVG-L14-T32H-MT-G18-1H2L-F1A
	External pilot air supply	Normally closed, pneumatic spring return	8164561	VUVG-L14-T32C-AZT-G18-1H2L-F1A
		Normally closed, mechanical spring return	8164562	VUVG-L14-T32C-MZT-G18-1H2L-F1A
		Normally open, pneumatic spring return	8164563	VUVG-L14-T32U-AZT-G18-1H2L-F1A
		Normally open, mechanical spring return	8164564	VUVG-L14-T32U-MZT-G18-1H2L-F1A
		1x normally open, 1x normally closed, pneumatic spring return	8164565	VUVG-L14-T32H-AZT-G18-1H2L-F1A
		1x normally open, 1x normally closed, mechanical spring return	8164566	VUVG-L14-T32H-MZT-G18-1H2L-F1A
	<b>5/2-way valve, single solenoid</b>			
	Internal pilot air supply	Mechanical spring return	8164557	VUVG-L14-M52-MT-G18-1H2L-F1A
	External pilot air supply	Pneumatic/mechanical spring return	8164567	VUVG-L14-M52-AZT-G18-1H2L-F1A
		Mechanical spring return	8164568	VUVG-L14-M52-MZT-G18-1H2L-F1A
	<b>5/2-way valve, double solenoid</b>			
	External pilot air supply		8164569	VUVG-L14-B52-ZT-G18-1H2L-F1A
<b>5/3-way valve</b>				
Internal pilot air supply	Mid-position closed	8164558	VUVG-L14-P53C-T-G18-1H2L-F1A	
	Mid-position exhausted	8164559	VUVG-L14-P53E-T-G18-1H2L-F1A	
	Mid-position pressurised	8164560	VUVG-L14-P53U-T-G18-1H2L-F1A	
External pilot air supply	Mid-position closed	8164570	VUVG-L14-P53C-ZT-G18-1H2L-F1A	
	Mid-position exhausted	8164571	VUVG-L14-P53E-ZT-G18-1H2L-F1A	
	Mid-position pressurised	8164572	VUVG-L14-P53U-ZT-G18-1H2L-F1A	

## Ordering data

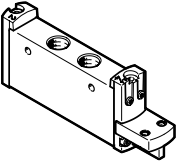
Ordering data				
	Description	Part no.	Type	
<b>In-line valve G1/8, to ISO15218</b>				
	<b>2x 3/2-way valve</b>			
	Internal pilot air supply	Normally closed, pneumatic spring return	8033523	VUVG-L14-T32C-A-G18-P1
		Normally open, pneumatic spring return	8033524	VUVG-L14-T32U-A-G18-P1
		1x normally open, 1x normally closed, pneumatic spring return	8033525	VUVG-L14-T32H-A-G18-P1
		Normally closed, mechanical spring return	8033526	VUVG-L14-T32C-M-G18-P1
		Normally open, mechanical spring return	8033527	VUVG-L14-T32U-M-G18-P1
		1x normally open, 1x normally closed, mechanical spring return	8033528	VUVG-L14-T32H-M-G18-P1
	<b>5/2-way valve, single solenoid</b>			
	Internal pilot air supply	Pneumatic spring return	8033529	VUVG-L14-M52-A-G18-P1
		Mechanical spring return	8033530	VUVG-L14-M52-M-G18-P1
	<b>5/2-way valve, double solenoid</b>			
	Internal pilot air supply	–	8033531	VUVG-L14-B52-G18-P1
	<b>5/3-way valve</b>			
Internal pilot air supply	Mid-position closed, mechanical spring return	8033532	VUVG-L14-P53C-G18-P1	
	Mid-position exhausted, mechanical spring return	8033533	VUVG-L14-P53E-G18-P1	
	Mid-position pressurised, mechanical spring return	8033534	VUVG-L14-P53U-G18-P1	



## Manifold assembly

### In-line valves for manifold assembly



### Dimensions

Download CAD data → [www.festo.com](http://www.festo.com)

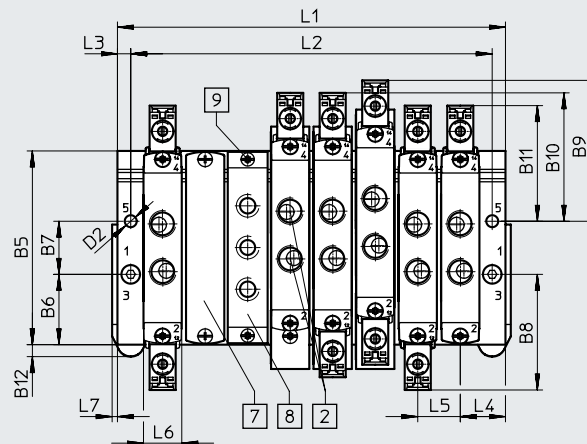
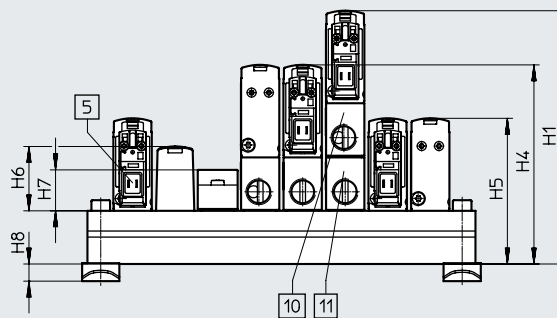
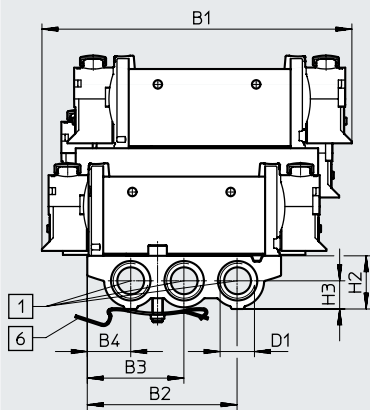

 **Note**  
More dimensions  
E-boxes  
→ Page 112

- [1] Ports 1, 3 and 5: G1/4 (at both ends)
- [2] Ports 1, 2, 3, 4 and 5 on the valve: G1/8
- [5] Electrical connection for E-boxes and accessories

- [6] H-rail mounting (two M4x25 screws are required for mounting)
- [7] Cover plate

- [8] Supply plate, ports 1, 3 and 5: G1/8
- [9] Valves/cover plate mounting on manifold rail: M2.5 thread

- [10] Vertical pressure supply plate
- [11] Vertical pressure exhaust plate

Type	B1	B2	B3	B4	B5	B6	B7	B8	B9	B10	B11	B12	D1	D2
VABM-L1-14S-G14	116.6	56.6	36.5	16.4	72.9	26.5	20	43.5	53.1	48.3	43.5	4.5	G1/4	4.5

Type	H1	H2	H3	H4	H5	H6	H7	H8	L3	L4	L5	L6	L7
VABM-L1-14S-G14	95.3	20	10.6	74.9	54.8	23.9	15.4	6.5	5	17	16	14.5	2

Valve positions	2	3	4	5	6	7	8	9	10	12	14	16	22
L1	50	66	82	98	114	130	146	162	178	210	242	274	306
L2	40	56	72	88	104	120	136	152	168	200	232	264	296
Weight of VABM [g]	118	159	200	241	282	323	364	405	446	528	610	692	938

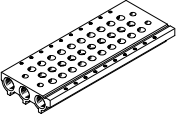

## Ordering data

Technical data – Manifold rails								
	Connection 1, 3, 5	KBK	Material <sup>2)</sup>	Operating pressure		Max. tightening torque for assembly [Nm]		
				[MPa]	[bar]	Valve	H-rail	Wall
	G1/4	2 <sup>1)</sup>	Wrought aluminium alloy	0.15 ... 0.8	1.5 ... 8	0.65	1.5	3

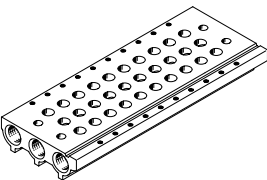
- 1) More information: [www.festo.com/x/topic/kbk](http://www.festo.com/x/topic/kbk)  
 2) Information on materials: RoHS-compliant.

Ordering data – Manifold rail				
		Description	Part no.	Type
<b>Manifold rail for in-line valves (manifold assembly)</b>				
	For size G1/8	2 valve positions	★ 566618	VABM-L1-14S-G14-2
		3 valve positions	★ 566619	VABM-L1-14S-G14-3
		4 valve positions	★ 566620	VABM-L1-14S-G14-4
		5 valve positions	566621	VABM-L1-14S-G14-5
		6 valve positions	★ 566622	VABM-L1-14S-G14-6
		7 valve positions	566623	VABM-L1-14S-G14-7
		8 valve positions	★ 566624	VABM-L1-14S-G14-8
		9 valve positions	566625	VABM-L1-14S-G14-9
		10 valve positions	★ 566626	VABM-L1-14S-G14-10
		12 valve positions	566627	VABM-L1-14S-G14-12
		14 valve positions	566628	VABM-L1-14S-G14-14
		16 valve positions	566629	VABM-L1-14S-G14-16

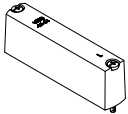

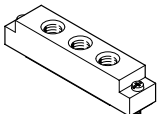
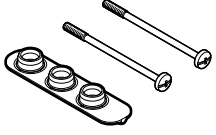
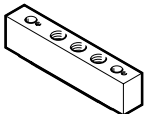
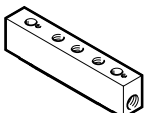

## Ordering data

Ordering data – Accessories		Description	Part no.	Type
<b>Cover plate</b> <span style="float: right;">Datasheets → Internet: vabb</span>				
	For valve position on manifold rail, including screws and seal		★ 569989	VABB-L1-14
<b>Separator</b> <span style="float: right;">Datasheets → Internet: vabd</span>				
	For creating pressure zones		569996	VABD-10-B
<b>Supply plate</b> <span style="float: right;">Datasheets → Internet: vabf</span>				
	For valve position on manifold rail, including screws and seal		569993	VABF-L1-14-P3A4-G18
<b>Seals for in-line valves</b> <span style="float: right;">Datasheets → Internet: vabd</span>				
	<b>In-line valves VUVG-LK</b>			
	For G1/8 in-line valves	Delivery quantity: 10 sets (each with 2 screws and 1 seal)	– Suitable for battery production	★ 8043720 8168886
				VABD-L1-14XK-S-G18-S VABD-L1-14XK-S-G18-F1A
	<b>In-line valves VUVG-L</b>			
For G1/8 in-line valves	Delivery quantity: 10 sets (each with 2 screws and 1 seal)	– Suitable for battery production	★ 566675 8168589	
			VABD-L1-14X-S-G18 VABD-L1-14X-S-G18-F1A	
<b>Vertical pressure supply plate</b>				
	Pneumatic connection 1: G1/8	Terminal code CP	574593	VABF-L1-P3A3-G18
<b>Vertical pressure exhaust plate</b>				
	Pneumatic connection 3, 5: G1/8	Terminal code CR	574595	VABF-L1-P7A13-G18

## Datasheet

### Function

2x 3/2C, 2x 3/2U, 2x 3/2H  
 5/2-way, single solenoid  
 5/2-way, double solenoid valve  
 5/3C, 5/3U, 5/3E

-  - Size 18 mm
-  - Flow rate  
780 ... 1380 l/min
-  - Voltage  
5, 12 and 24 V DC  
24, 110 and 230 V AC
-  - Voltage VUVG-...-P1  
12 and 24 V DC  
24, 110 and 230 V AC

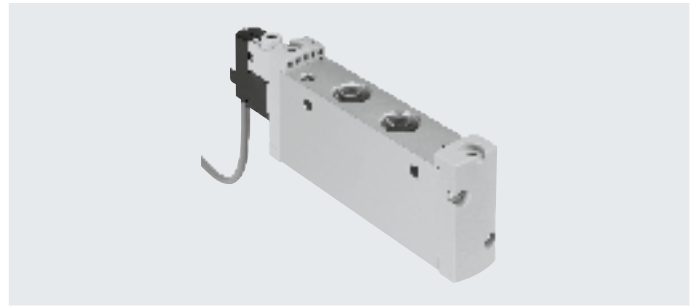

Circuit symbols → page 14

General technical data VUVG-L												
Valve function	T32-A			T32-M			M52-R	B52	M52-M	P53		
Normal position	C <sup>1)</sup>	U <sup>2)</sup>	H <sup>4)</sup>	C <sup>1)</sup>	U <sup>2)</sup>	H <sup>4)</sup>	–	–	–	C <sup>1)</sup>	U <sup>2)</sup>	E <sup>3)</sup>
Stable position	Monostable							Bistable		Monostable		
Pneumatic spring return	Yes			No			Yes <sup>5)</sup>	–	No	–		
Mechanical spring return	No			Yes			Yes <sup>5)</sup>	–	Yes	Yes		
Vacuum operation at port 1	No			Only with external pilot air supply								
Size [mm]	18											
Design	Piston spool											
Sealing principle	Soft											
Actuation type	Electrical											
Type of control	Piloted											
Pilot air supply	Internal/external											
Exhaust function	Can be throttled											
Manual override	VUVG-...		Choice of non-detenting, covered, non-detenting/detenting or detenting									
	VUVG-...-P1		Non-detenting, non-detenting/detenting									
Type of mounting	Optionally via through-holes <sup>6)</sup> or on manifold rail											
Mounting position	Any											
Nominal width [mm]	5.7						6.9	7.3	6.9	6.5	6.3	
Standard nominal flow rate [l/min]	880	970	950	870	990	920	1300	1380	1300	1200	1000	910
Flow rate on manifold rail	780	980	820	780	960	820	1300	1370	1300	1180	1220	1050
<b>Switching time</b>												
VUVG-...	On/off [ms]	13/27			15/22			15/31	–	10/45	15/48	
	Changeover [ms]	–			–			–	11	–	29	
VUVG-...P1	On/off [ms]	13/18			16/15			16/22	–	14/26	15/32	
	Changeover [ms]	–			–			–	12	–	21	
Pneumatic connection	1, 2, 3, 4, 5		G1/4									
	12/14		M5									
Product weight [g]	VUVG-...		164			154			164	154	160	
	VUVG-...-P1		140			142			140	142	136	
Certificate-issuing authority	VUVG-...-P1		UL MH19482									
Certification	VUVG-...		RCM mark									
	VUVG-...		c UL us - Recognized (OL)									
	VUVG-...-P1											
<b>CE marking (see declaration of conformity)<sup>7)</sup></b>												
VUVG-...		To EU EMC Directive										
VUVG-...-P1		To EU Low Voltage Directive										
Corrosion resistance class CRC <sup>8)</sup>	2											

1) C=Normally closed/mid-position closed

2) U=Normally open/mid-position pressurised

3) E=Mid-position exhausted

4) H=2x 3/2-way valve in one housing with 1x normally closed and 1x normally open

5) Combined reset method

6) If several valves are to be screwed together via the through-holes to form a block, a minimum distance of 0.3 mm must be ensured by inserting spacers.

7) For information about the area of use, see the EC declaration of conformity at: [www.festo.com/catalogue/...](http://www.festo.com/catalogue/...) → Support/Downloads.

If the devices are subject to usage restrictions in residential, commercial or light-industrial environments, further measures for the reduction of the emitted interference may be necessary.

8)

More information: [www.festo.com/x/topic/kbk](http://www.festo.com/x/topic/kbk)

## Datasheet

Operating and environmental conditions			T32-A <sup>1)</sup>	T32-M <sup>3)</sup>	M52-R <sup>2)</sup>	B52	M52-M <sup>3)</sup>	P53
Valve function								
Operating medium			Compressed air to ISO 8573-1:2010 [7:4:4]					
Note on the operating/pilot medium			Lubricated operation possible (in which case lubricated operation will always be required)					
Operating pressure	Internal	[MPa]	0.15 ... 0.8	0.3 ... 0.8	0.25 ... 0.8	0.15 ... 0.8	0.3 ... 0.8	
		[bar]	1.5 ... 8	3 ... 8	2.5 ... 8	1.5 ... 8	3 ... 8	
	External VUVG-...	[MPa]	0.15 ... 1	-0.09 ... 1				
		[bar]	1.5 ... 10	-0.9 ... 10				
Pilot pressure <sup>4)</sup>		[MPa]	0.15 ... 0.8	0.2 ... 0.8	0.25 ... 0.8	0.15 ... 0.8	0.3 ... 0.8	
		[bar]	1.5 ... 8	2 ... 8	2.5 ... 8	1.5 ... 8	3 ... 8	
Ambient temperature	VUVG-...	[°C]	-5 ... +50, with holding current reduction -5 ... +60					
	VUVG-...-P1	[°C]	-5 ... +50 for mounting on manifold rail, -5 ... +60					
Temperature of medium	VUVG-...	[°C]	-5 ... +50, with holding current reduction -5 ... +60					
	VUVG-...-P1	[°C]	-5 ... +50 for mounting on manifold rail, -5 ... +60					

- 1) Pneumatic spring  
2) Mixed, pneumatic/mechanical spring  
3) Mechanical spring  
4) Minimum pilot pressure 50% of operating pressure

Electrical data			
Electrical connection	VUVG-...		Via E-box → page 110
	VUVG-...-P1		Via electric pilot valve
Pilot interface	VUVG-...-P1		To ISO 15218
Operating voltage	VUVG-...	[V DC]	5, 12 and 24 ±10%
		[V DC]	12 and 24 ±10%
	VUVG-...-P1	[V AC]	24, 110 and 230 ±10%
Power	VUVG-...	[W]	1, reduced to 0.35 with holding current reduction
	VUVG-...-P1	[W]	1.3
Duty cycle		[%]	100
<b>Degree of protection to EN 60529</b>			
	VUVG-...		IP40 (with plug socket), IP65 (with M8)
	VUVG-...-P1		IP65, with electric pilot valve and plug socket

Safety characteristics		
Max. positive test pulse with 0 signal	[µs]	700
Max. negative test pulse with 1 signal	[µs]	900
Shock resistance		Shock test with severity level 2 to FN 942017-5 and EN 60068-2-27
Vibration resistance		Transport application test with severity level 2 to FN 942017-4 and EN 60068-2-6

Information on materials	
Housing	Wrought aluminium alloy
Seals	HNBR, NBR
Note on materials	RoHS-compliant
PWIS conformity	VDMA24364-B1/B2-L

Datasheet

Dimensions VUVG-...

Download CAD data → [www.festo.com](http://www.festo.com)

2x 3/2-way, 5/2-way and 5/3-way valve

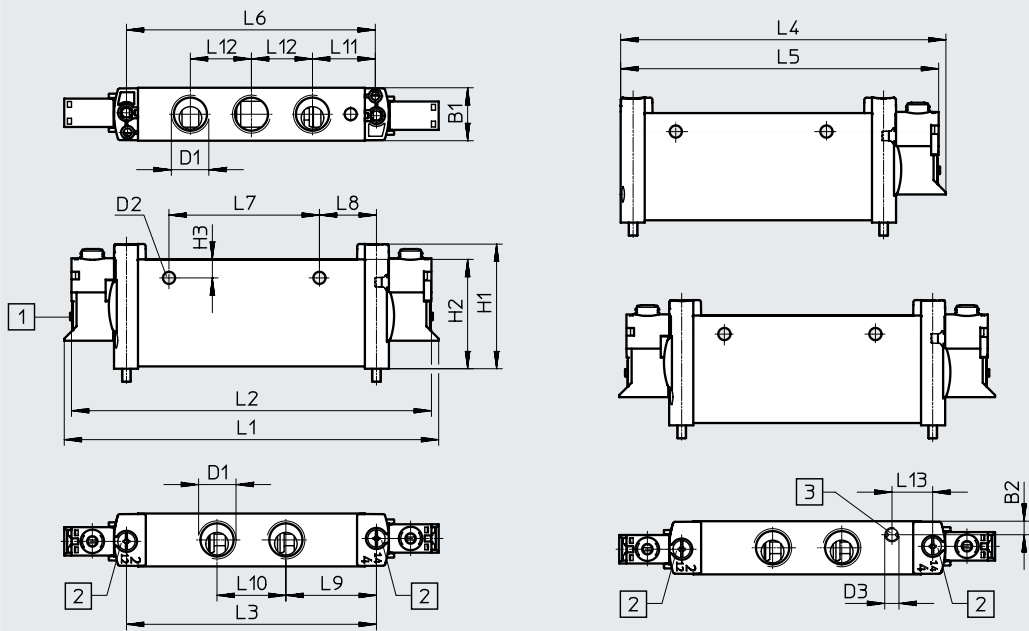

- - **Note**  
 More dimensions  
 E-boxes  
 → Page 112

- [1] Electrical connection without E-box
- [2] Retaining screw
- [3] Port for external pilot air supply

Type	B1	B2	D1	D2 ∅	D3	H1	H2	H3	L1	L2	L3
VUVG-L18-...	18.3	4.5	G1/4	4.2	M5	43.1	37.8	6.4	129.4	124.4	86.4
VUVG-S18-...											

Type	L4	L5	L6	L7	L8	L9	L10	L11	L12	L13
VUVG-L18-...	112.2	109.7	86	52	19.7	31.3	23.8	21.7	21.1	14
VUVG-S18-...										

Datasheet

Dimensions VUVG-...-P1

Download CAD data → [www.festo.com](http://www.festo.com)

2x 3/2-way, 5/2-way and 5/3-way valve

5/2-way valve, single solenoid

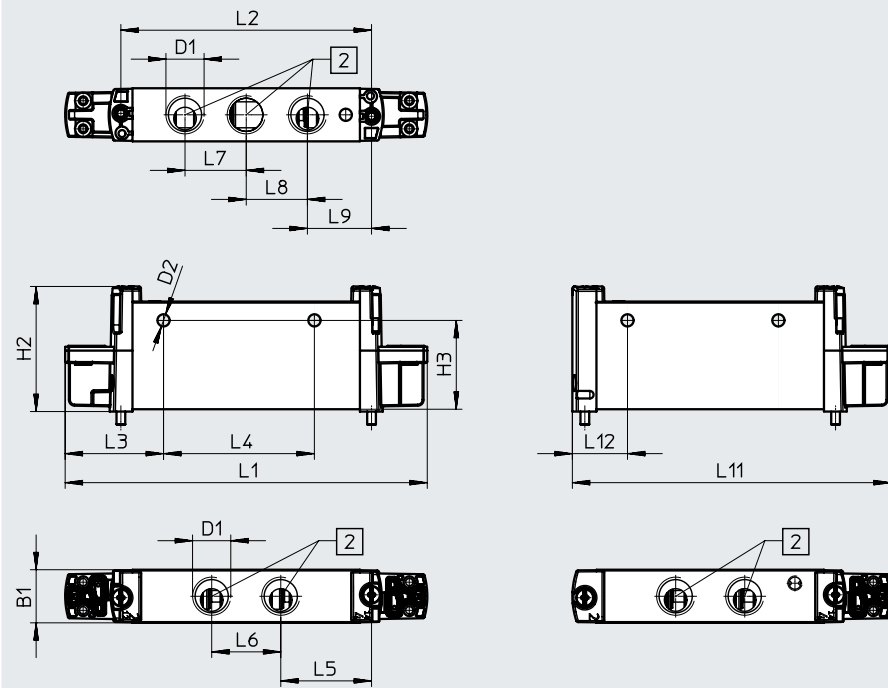

[2] Ports 1... 5

Type	B1	D1	D2	H2	H3	L1	L2	L3
VUVG-L18-...-P1	18.3	G1/4	∅ 4.2	43.1	30.6	124.8	86.4	33.9

  

Type	L4	L5	L6	L7	L8	L9	L11	L12
VUVG-L18-...-P1	52	31.3	23.8	21.1	21.1	22.1	109.9	19

## Ordering data

### ★ Core Range

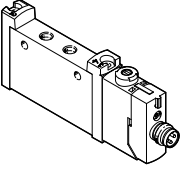
Ordering data		Description	Part no.	Type
<b>In-line valve G1/4, with E-box R8</b>				
	<b>2x 3/2-way valve</b>			
	Internal pilot air supply	Normally closed, pneumatic spring return	★ 8031525	VUVG-L18-T32C-AT-G14-1R8L
	<b>5/2-way valve, single solenoid</b>			
	Internal pilot air supply	Pneumatic/mechanical spring return	★ 8031531	VUVG-L18-M52-RT-G14-1R8L
		Mechanical spring return	★ 8031532	VUVG-L18-M52-MT-G14-1R8L
	<b>5/3-way valve</b>			
Internal pilot air supply	Mid-position closed, mechanical spring return	★ 8031534	VUVG-L18-P53C-T-G14-1R8L	

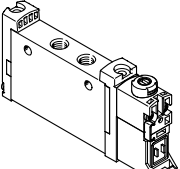
Ordering data		Description	Part no.	Type
<b>In-line valve G1/4, without E-box</b>				
	<b>2x 3/2-way valve</b>			
	Internal pilot air supply	Normally closed, pneumatic spring return	574422	VUVG-L18-T32C-AT-G14-1P3
		Normally open, pneumatic spring return	574423	VUVG-L18-T32U-AT-G14-1P3
		1x normally open, 1x normally closed, pneumatic spring return	574424	VUVG-L18-T32H-AT-G14-1P3
		Normally closed, mechanical spring return	574425	VUVG-L18-T32C-MT-G14-1P3
		Normally open, mechanical spring return	574426	VUVG-L18-T32U-MT-G14-1P3
		1x normally open, 1x normally closed, mechanical spring return	574427	VUVG-L18-T32H-MT-G14-1P3
	External pilot air supply	Normally closed, mechanical spring return	574434	VUVG-L18-T32C-MZT-G14-1P3
		Normally open, mechanical spring return	574435	VUVG-L18-T32U-MZT-G14-1P3
		1x normally open, 1x normally closed, mechanical spring return	574436	VUVG-L18-T32H-MZT-G14-1P3
	<b>5/2-way valve, single solenoid</b>			
	Internal pilot air supply	Pneumatic/mechanical spring return	574428	VUVG-L18-M52-RT-G14-1P3
		Mechanical spring return	574429	VUVG-L18-M52-MT-G14-1P3
	External pilot air supply	Mechanical spring return	574438	VUVG-L18-M52-MZT-G14-1P3
		Pneumatic/mechanical spring return	574437	VUVG-L18-M52-RZT-G14-1P3
	<b>5/2-way valve, double solenoid</b>			
Internal pilot air supply		574430	VUVG-L18-B52-T-G14-1P3	
External pilot air supply		574439	VUVG-L18-B52-ZT-G14-1P3	

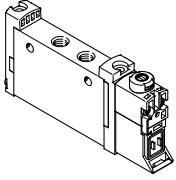
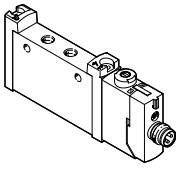
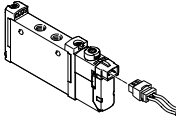

## Ordering data

Ordering data		Description	Part no.	Type	
<b>In-line valve G1/4, without E-box</b>					
	<b>5/3-way valve</b>				
	Internal pilot air supply	Mid-position closed, mechanical spring return	574431	VUVG-L18-P53C-T-G14-1P3	
		Mid-position exhausted, mechanical spring return	574432	VUVG-L18-P53E-T-G14-1P3	
		Mid-position pressurised, mechanical spring return	574433	VUVG-L18-P53U-T-G14-1P3	
	External pilot air supply	Mid-position closed, mechanical spring return	574440	VUVG-L18-P53C-ZT-G14-1P3	
		Mid-position exhausted, mechanical spring return	574441	VUVG-L18-P53E-ZT-G14-1P3	
Mid-position pressurised, mechanical spring return		574442	VUVG-L18-P53U-ZT-G14-1P3		
<b>In-line valve G1/4, with E-box R8</b>					
	<b>2x 3/2-way valve</b>				
	Internal pilot air supply	Normally open, pneumatic spring return	8031526	VUVG-L18-T32U-AT-G14-1R8L	
		1x normally open, 1x normally closed, pneumatic spring return	8031527	VUVG-L18-T32H-AT-G14-1R8L	
		Normally closed, mechanical spring return	8031528	VUVG-L18-T32C-MT-G14-1R8L	
		Normally open, mechanical spring return	8031529	VUVG-L18-T32U-MT-G14-1R8L	
		1x normally open, 1x normally closed, mechanical spring return	8031530	VUVG-L18-T32H-MT-G14-1R8L	
	<b>5/2-way valve, double solenoid</b>				
	Internal pilot air supply		8031533	VUVG-L18-B52-T-G14-1R8L	
	<b>5/3-way valve</b>				
	Internal pilot air supply	Mid-position exhausted, mechanical spring return	8031535	VUVG-L18-P53E-T-G14-1R8L	
Mid-position pressurised, mechanical spring return		8031536	VUVG-L18-P53U-T-G14-1R8L		
<b>In-line valve G1/4, with E-box H2</b>					
	<b>5/2-way valve, single solenoid</b>				
	Internal pilot air supply	Pneumatic/mechanical spring return	578823	VUVG-L18-M52-RT-G14-1H2L-W1	

## Ordering data

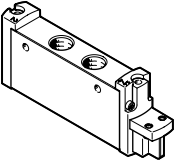
Ordering data	Description	Part no.	Type	
<b>In-line valve G1/4, to ISO 15218</b>				
	<b>2x 3/2-way valve</b>			
	Internal pilot air supply	Normally closed, pneumatic spring return	8033547	VUVG-L18-T32C-A-G14-P1
		Normally open, pneumatic spring return	8033548	VUVG-L18-T32U-A-G14-P1
		1x normally open, 1x normally closed, pneumatic spring return	8033549	VUVG-L18-T32H-A-G14-P1
		Normally closed, mechanical spring return	8033550	VUVG-L18-T32C-M-G14-P1
		Normally open, mechanical spring return	8033551	VUVG-L18-T32U-M-G14-P1
		1x normally open, 1x normally closed, mechanical spring return	8033552	VUVG-L18-T32H-M-G14-P1
	<b>5/2-way valve, single solenoid</b>			
	Internal pilot air supply	Pneumatic/mechanical spring return	8033553	VUVG-L18-M52-R-G14-P1
		Mechanical spring return	8033554	VUVG-L18-M52-M-G14-P1
<b>5/2-way valve, double solenoid</b>				
Internal pilot air supply		8033555	VUVG-L18-B52-G14-P1	
<b>5/3-way valve</b>				
Internal pilot air supply	Mid-position closed, mechanical spring return	8033556	VUVG-L18-P53C-G14-P1	
	Mid-position exhausted, mechanical spring return	8033557	VUVG-L18-P53E-G14-P1	
	Mid-position pressurised, mechanical spring return	8033558	VUVG-L18-P53U-G14-P1	

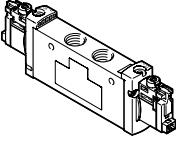
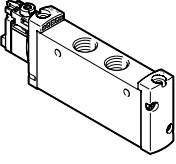
Ordering data	Description	Part no.	Type	
<b>In-line valve G1/4, for battery manufacturing</b>				
	<b>2x 3/2-way valve</b>			
	Internal pilot air supply	Normally closed, pneumatic spring return	8172829	VUVG-L18-T32C-AT-G14-1H2L-F1A
		Normally closed, mechanical spring return	8172830	VUVG-L18-T32C-MT-G14-1H2L-F1A
		Normally open, pneumatic spring return	8172831	VUVG-L18-T32U-AT-G14-1H2L-F1A
		Normally open, mechanical spring return	8172832	VUVG-L18-T32U-MT-G14-1H2L-F1A
		1x normally open, 1x normally closed, pneumatic spring return	8172833	VUVG-L18-T32H-AT-G14-1H2L-F1A
		1x normally open, 1x normally closed, mechanical spring return	8172834	VUVG-L18-T32H-MT-G14-1H2L-F1A
	External pilot air supply	Normally closed, mechanical spring return	8172841	VUVG-L18-T32C-MZT-G14-1H2L-F1A
		Normally open, pneumatic spring return	8172842	VUVG-L18-T32U-MZT-G14-1H2L-F1A
		1x normally open, 1x normally closed, mechanical spring return	8172843	VUVG-L18-T32H-MZT-G14-1H2L-F1A
	<b>5/2-way valve, single solenoid</b>			
	Internal pilot air supply	Pneumatic/mechanical spring return	8172835	VUVG-L18-M52-RT-G14-1H2L-F1A
		Mechanical spring return	8172836	VUVG-L18-M52-MT-G14-1H2L-F1A
	External pilot air supply	Pneumatic/mechanical spring return	8172844	VUVG-L18-M52-RZT-G14-1H2L-F1A
		Mechanical spring return	8172845	VUVG-L18-M52-MZT-G14-1H2L-F1A
	<b>5/2-way valve, double solenoid</b>			
Internal pilot air supply		8172837	VUVG-L18-B52-T-G14-1H2L-F1A	
External pilot air supply		8172846	VUVG-L18-B52-ZT-G14-1H2L-F1A	
<b>5/3-way valve</b>				
Internal pilot air supply	Mid-position closed	8172838	VUVG-L18-P53C-T-G14-1H2L-F1A	
	Mid-position exhausted	8172839	VUVG-L18-P53E-T-G14-1H2L-F1A	
		8172840	VUVG-L18-P53U-T-G14-1H2L-F1A	
External pilot air supply	Mid-position closed	8172847	VUVG-L18-P53C-ZT-G14-1H2L-F1A	
	Mid-position exhausted	8172848	VUVG-L18-P53E-ZT-G14-1H2L-F1A	
	Mid-position pressurised	8172849	VUVG-L18-P53U-ZT-G14-1H2L-F1A	

## Manifold assembly

In-line valves for  
Manifold assembly



### Dimensions

Download CAD data → [www.festo.com](http://www.festo.com)

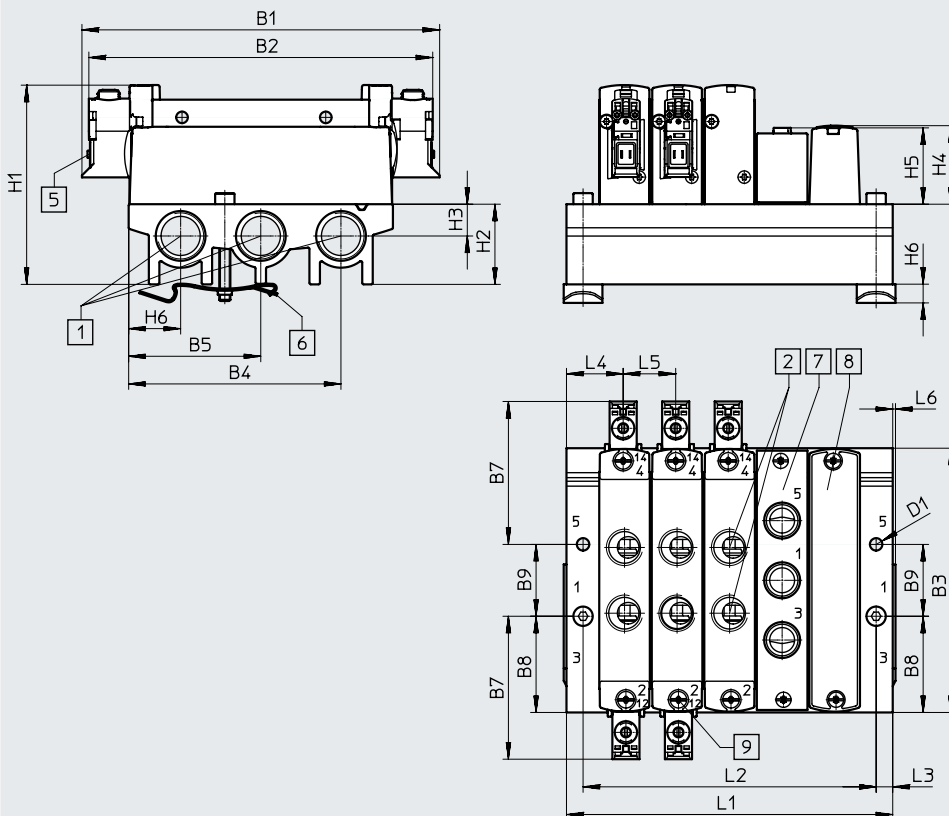

-  - **Note**

More dimensions

E-boxes

→ Page 112

- [1] Ports 1, 3 and 5: G3/8 (at both ends)
- [2] Ports 2 and 4: G1/4
- [5] Electrical connection for E-boxes and accessories

- [6] H-rail mounting (two M4x35 screws are required for mounting)

- [7] Cover plate
- [8] Supply plate, ports 1, 3 and 5: G1/4

- [9] Valves/cover plate mounting on manifold rail: M3 thread

Type	B1	B2	B3	B4	B5	B6	B7	B8	B9	D1
VABM-L1-18S-G38	129.4	124.4	95.6	76.8	47.8	18.8	51.7	34.8	26	4.5

Type	H1	H2	H3	H4	H5	H6	L3	L4	L5	L6
VABM-L1-18S-G38	72.1	29	11.5	28.4	27.6	6.5	6	20.5	19	1

Valve positions	2	3	4	5	6	7	8	9	10	12	14	16
L1	61	80	99	118	137	156	175	194	213	251	289	327
L2	49	68	87	106	125	144	163	182	201	239	277	315
Weight of VABM [g]	118	159	200	241	282	323	364	405	446	528	610	692

## Ordering data

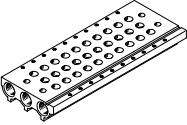

Technical data – Manifold rails								
	Connection	KBK	Material <sup>2)</sup>	Operating pressure		Max. tightening torque for assembly [Nm]		
	1, 3, 5			[MPa]	[bar]	Valve	H-rail	Wall
	G3/8	2 <sup>1)</sup>	Wrought aluminium alloy	-0.09 ... 1	-0.9 ... 10	1.18	1.5	3

1) More information: [www.festo.com/x/topic/kbk](http://www.festo.com/x/topic/kbk)

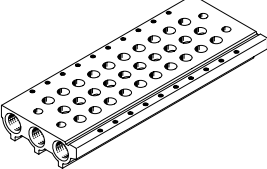
2) Information on materials: RoHS-compliant.

Ordering data – Manifold rail				
		Description	Part no.	Type
<b>Manifold rail for in-line valve</b>				
	For size G1/4	2 valve positions	★ 574455	VABM-L1-18S-G38-2
		3 valve positions	★ 574456	VABM-L1-18S-G38-3
		4 valve positions	★ 574457	VABM-L1-18S-G38-4
		5 valve positions	574458	VABM-L1-18S-G38-5
		6 valve positions	★ 574459	VABM-L1-18S-G38-6
		7 valve positions	574460	VABM-L1-18S-G38-7
		8 valve positions	★ 574461	VABM-L1-18S-G38-8
		9 valve positions	574462	VABM-L1-18S-G38-9
		10 valve positions	★ 574463	VABM-L1-18S-G38-10
		12 valve positions	574464	VABM-L1-18S-G38-12
		14 valve positions	574465	VABM-L1-18S-G38-14
		16 valve positions	574466	VABM-L1-18S-G38-16

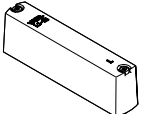
## Ordering data

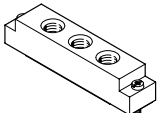
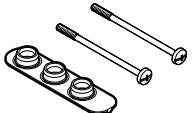
Ordering data – Accessories			
	Description	Part no.	Type
<b>Cover plate</b> <span style="float: right;">Datasheets → Internet: vabb</span>			
	For valve position on manifold rail, including screws and seal	★ 574482	VABB-L1-18
	For valve position on manifold rail, including screws and seal, suitable for battery production	8172852	VABB-L1-18-F1A
<b>Separator</b> <span style="float: right;">Datasheets → Internet: vabd</span>			
	For creating pressure zones	574483	VABD-14-B
	For creating pressure zones, suitable for battery production	8168590	VABD-14-B-F1A
<b>Supply plate</b> <span style="float: right;">Datasheets → Internet: vabf</span>			
	For valve position on manifold rail, including screws and seal	574481	VABF-L1-18-P3A4-G14
	For valve position on manifold rail, including screws and seal, suitable for battery production	8172851	VABF-L1-18-P3A4-G14-F1A
<b>Seals for in-line valves</b> <span style="float: right;">Datasheets → Internet: vabd</span>			
	For G1/4 in-line valves	Delivery quantity: 10 sets (each with 2 screws and 1 seal)	★ 574479
	For G1/4 in-line valves, suitable for battery production	Delivery quantity: 10 sets (each with 2 screws and 1 seal)	8172850
			VABD-L1-18X-S-G14
			VABD-L1-18X-S-G14-F1A

 **Note**



Connect supply plate at port 1 with compressed air.  
Reverse operation (pressure at port 3, 5) is not permissible.

## Datasheet

**Function**

5/2-way, single solenoid  
5/2-way, double solenoid valve  
5/3C, 5/3U, 5/3E

Circuit symbols → page 14

-  - Size 10 mm
-  - Flow rate  
80 ... 100 l/min
-  - Voltage  
5, 12 and 24 V DC



General technical data VUVG-B						
Valve function		M52-R	B52	M52-M	P53	
Normal position		–	–	–	C <sup>1)</sup>	U <sup>2)</sup> E <sup>3)</sup>
Stable position		Monostable	Bistable	Monostable	Monostable	
Pneumatic spring return		Yes <sup>4)</sup>	–	No	–	
Mechanical spring return		Yes <sup>4)</sup>	–	Yes	Yes	
Vacuum operation at port 1		Only with external pilot air supply				
Design		Piston spool				
Sealing principle		Soft				
Actuation type		Electrical				
Type of control		Piloted				
Pilot air supply		External, internal; can be selected via sub-base				
Exhaust function		Can be throttled				
Manual override		Choice of non-detenting, covered, non-detenting/detenting or detenting				
Type of mounting		On manifold rail				
Mounting position		Any				
Nominal width	[mm]	2		1.4	2	
Standard nominal flow rate	[l/min]	100		80	90	
Flow rate on manifold rail M3	[l/min]	100		80	90	
Switching time on/off	[ms]	7/15	–	7/21	8/25	
Changeover time	[ms]	–	5	–	14	
Size	[mm]	10				
Connection	1, 3, 5	M7 in manifold rail				
	2, 4	M5 in manifold rail				
	12/14, 82/84	M5 in manifold rail				
Product weight	[g]	38	49	37	49	
Certification		c UL us - Recognized (OL)				
		RCM				
CE marking (see declaration of conformity) <sup>5)</sup>		To EU EMC Directive				
Corrosion resistance class CRC <sup>6)</sup>		2				

1) C=Normally closed/mid-position closed

2) U=Normally open/mid-position pressurised

3) E=Mid-position exhausted

4) Combined reset method

5) For information about the area of use, see the EC declaration of conformity at: [www.festo.com/catalogue/...](http://www.festo.com/catalogue/...) → Support/Downloads.

If the devices are subject to usage restrictions in residential, commercial or light-industrial environments, further measures for the reduction of the emitted interference may be necessary.

6)

More information: [www.festo.com/x/topic/kbk](http://www.festo.com/x/topic/kbk)

## Datasheet

Operating and environmental conditions			M52-R <sup>1)</sup>	B52	M52-M <sup>2)</sup>	P53
Valve function						
Operating medium			Compressed air to ISO 8573-1:2010 [7:4:4]			
Operating pressure	Internal	[MPa]	0.25 ... 0.8	0.15 ... 0.8	0.3 ... 0.8	
		[bar]	2.5 ... 8	1.5 ... 8	3 ... 8	
	External	[MPa]	-0.09 ... 1		-0.09 ... 0.8	-0.09 ... 1
		[bar]	-0.9 ... 10		-0.9 ... 8	-0.9 ... 10
Pilot pressure		[MPa]	0.25 ... 0.8	0.15 ... 0.8	0.3 ... 0.8	
		[bar]	2.5 ... 8	1.5 ... 8	3 ... 8	
Ambient temperature		[°C]	-5 ... +50, with holding current reduction -5 ... +60			
Temperature of medium		[°C]	-5 ... +50, with holding current reduction -5 ... +60			

- 1) Mixed, pneumatic/mechanical spring  
2) Mechanical spring

Electrical data	
Electrical connection	Via E-box → page 110
Operating voltage	[V DC] 5, 12 and 24 ±10%
Power	[W] 1, reduced to 0.35 with holding current reduction
Duty cycle	[%] 100
Degree of protection to EN 60529	IP40 (with plug socket), IP65 (with M8)

Information on materials	
Housing	Wrought aluminium alloy
Seals	HNBR, NBR
Note on materials	RoHS-compliant
PWIS conformity	VDMA24364-B1/B2-L

## Dimensions

Download CAD data → [www.festo.com](http://www.festo.com)

5/2-way and 5/3-way valve

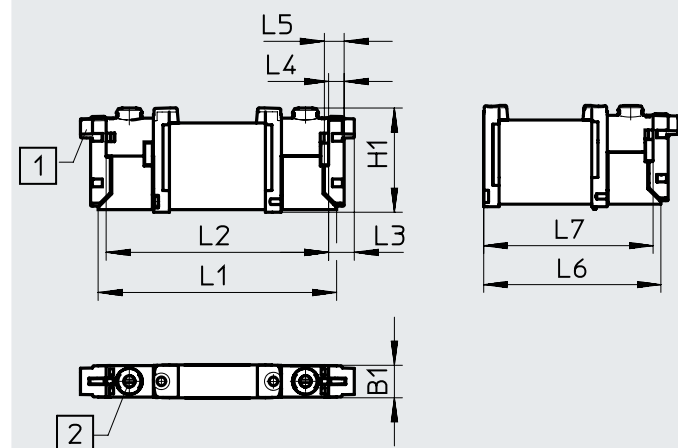

-  - **Note**  
More dimensions  
E-boxes  
→ Page 112

[1] Vertical electrical connection      [2] Manual override

Type	B1	H1	L1	L2	L3	L4	L5	L6	L7
VUVG-B10A-...F...	10.2	32.5	73.9	68.9	8	4.85	6.15	56.9	54.4

## Ordering data

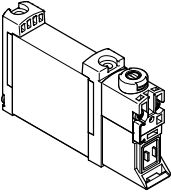
Ordering data	Description	Part no.	Type	
<b>Sub-base valve M3, without E-box</b>				
	<b>5/2-way valve, single solenoid</b>			
	External pilot air supply	Pneumatic/mechanical spring return	566448	VUVG-B10A-M52-RZT-F-1P3
		Mechanical spring return	574347	VUVG-B10A-M52-MZT-F-1P3
	<b>5/2-way valve, double solenoid</b>			
	External pilot air supply		566449	VUVG-B10A-B52-ZT-F-1P3
	<b>5/3-way valve</b>			
	External pilot air supply	Mid-position closed, mechanical spring return	566450	VUVG-B10A-P53C-ZT-F-1P3
		Mid-position exhausted, mechanical spring return	566451	VUVG-B10A-P53E-ZT-F-1P3
		Mid-position pressurised, mechanical spring return	566452	VUVG-B10A-P53U-ZT-F-1P3



## Manifold assembly

Sub-base valve for manifold assembly  
Connection M5



### Dimensions

Download CAD data → [www.festo.com](http://www.festo.com)

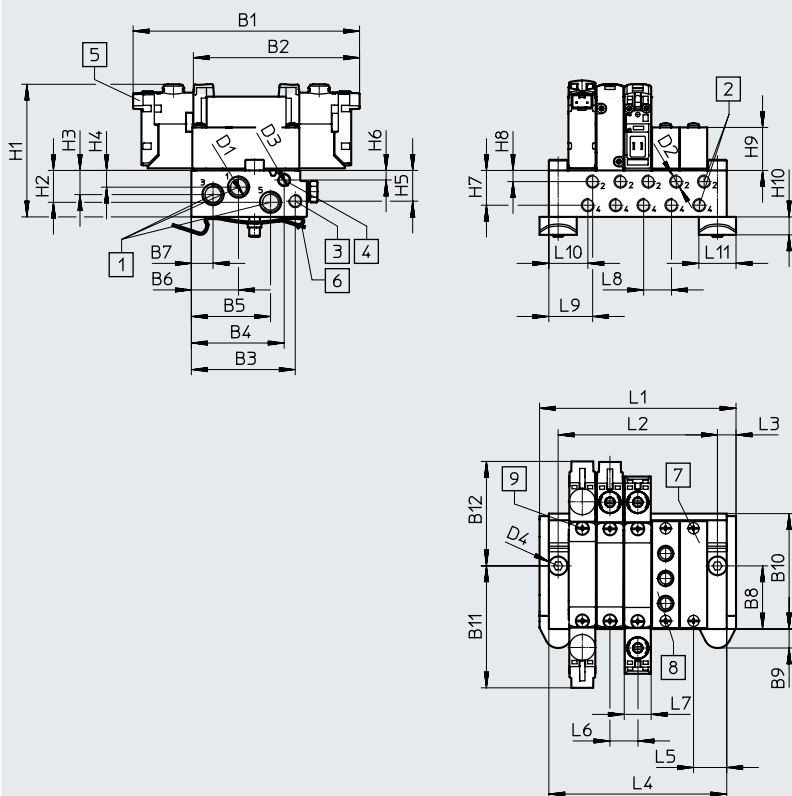

**Note**  
More dimensions  
E-boxes  
→ Page 112

- [1] Ports 1, 3 and 5: M7 (at both ends)
- [2] Ports 2, 4: M5
- [3] Ports 12, 14: M5
- [4] Ports 82, 84: M5
- [5] Electrical connection for E-boxes and accessories
- [6] H-rail mounting (two M4x25 screws are required for mounting)
- [7] Cover plate
- [8] Supply plate, ports 1, 3 and 5: M5
- [9] Valves/cover plate mounting on manifold rail: M2 thread

Type	B1	B2	B3	B4	B5	B6	B7	B8	B9	B10	B11	B12
VABM-L1-10AW-M7	84.9	62.4	39.1	35	29.8	17.8	8.2	24	7.2	43.5	45.8	39.2

Type	D1	D2	D3	D4	D5	H1	H2	H3	H4	H5	H6
VABM-L1-10AW-M7	M7	M5	M5	∅ 4.5	∅ 4	53.1	12	9.1	6.3	11.6	3.6

Type	H7	H8	H9	H10	H15	L3	L5	L6	L7	L8	L9	L10	L11
VABM-L1-10AW-M7	13.1	4.2	16.2	6.8	1.9	7.5	12.5	10.5	10.2	10.5	17	15.2	14

Valve positions	2	3	4	5	6	7	8	9	10	12	14	16
L1	43.5	54	64.5	75	85.5	97	107.5	117	127.5	148.5	169.5	190.5
L2	28.5	39	49.5	60	70.5	81	91.5	102	112.5	133.5	154.5	175.5
L4	36.5	47	57.5	68	78.5	89	99.5	110	120.5	141.5	162.5	183.5
Weight of VABM [g]	60	78	96	114	132	150	168	186	204	240	276	312

## Ordering data

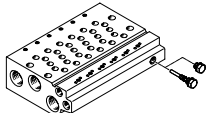

Technical data – Manifold rails <sup>1)</sup>	Connection			KBK	Material <sup>3)</sup>	Operating pressure		Max. tightening torque for assembly [Nm]		
	2, 4	1, 3, 5	12/14, 82/84			[MPa]	[bar]	Valve	H-rail	Wall
		M5	M7	M5	2 <sup>2)</sup>	Wrought aluminium alloy	-0.09 ... 1	-0.9 ... 10	0.45	1.5

1) Blanking plugs are included with the manifold rail.

2) More information: [www.festo.com/x/topic/kbk](http://www.festo.com/x/topic/kbk)

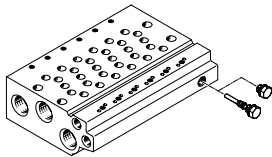
3) Information on materials: RoHS-compliant.

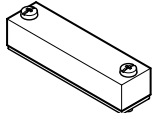
Ordering data – Manifold rails				
	Description		Part no.	Type
<b>Manifold rail for sub-base valve M3</b>				
	For size B10A (M3)	2 valve positions	566546	VABM-L1-10AW-M7-2
		3 valve positions	566547	VABM-L1-10AW-M7-3
		4 valve positions	566548	VABM-L1-10AW-M7-4
		5 valve positions	566549	VABM-L1-10AW-M7-5
		6 valve positions	566550	VABM-L1-10AW-M7-6
		7 valve positions	566551	VABM-L1-10AW-M7-7
		8 valve positions	566552	VABM-L1-10AW-M7-8
		9 valve positions	566553	VABM-L1-10AW-M7-9
		10 valve positions	566554	VABM-L1-10AW-M7-10
		12 valve positions	566555	VABM-L1-10AW-M7-12
		14 valve positions	566556	VABM-L1-10AW-M7-14
16 valve positions	566557	VABM-L1-10AW-M7-16		

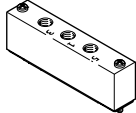
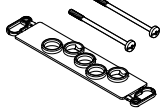
Ordering data – Accessories				
	Description		Part no.	Type
<b>Cover plate</b> <span style="float: right;">Datasheets → Internet: vabb</span>				
	For valve position on manifold rail, including screws and seal		569986	VABB-L1-10A
<b>Separator</b> <span style="float: right;">Datasheets → Internet: vabd</span>				
	For creating pressure zones		570872	VABD-4.2-B
<b>Supply plate</b> <span style="float: right;">Datasheets → Internet: vabf</span>				
	For valve position on manifold rail, including screws and seal		569990	VABF-L1-10A-P3A4-M5
<b>Seals</b> <span style="float: right;">Datasheets → Internet: vabd</span>				
	For sub-base valve M3	Delivery quantity: 10 sets (each with 2 screws and 1 seal)	566671	VABD-L1-10AB-S-M3

## Datasheet

### Function

2x 3/2C

5/2-way, single solenoid

5/2-way, double solenoid valve

Circuit symbols → page 14

-  - Size 10 mm

-  - Flow rate  
160 l/min

-  - Voltage  
24 V DC

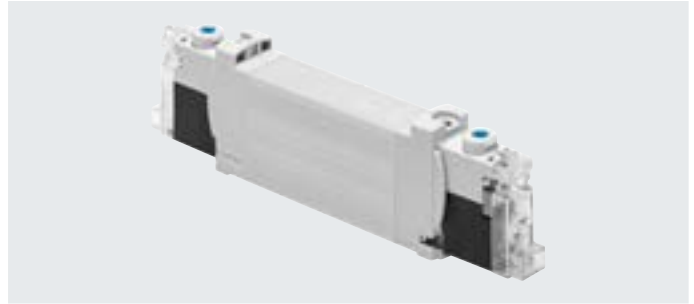

General technical data VUVG-BK				
Valve function		T32-A	M52-A	B52
Normal position		C <sup>1)</sup>	-	-
Stable position		Monostable		Bistable
Pneumatic spring return		Yes	Yes	-
Design		Piston spool		
Sealing principle		Soft		
Actuation type		Electrical		
Type of control		Piloted		
Pilot air supply		Internal		
Exhaust function		Can be throttled		
Manual override		Non-detenting, detenting		
Type of mounting		On manifold rail		
Mounting position		Any		
Standard nominal flow rate	[l/min]	160	160	160
Switching time on/off	[ms]	12/14	14/17	-
Changeover time	[ms]	-	-	7
Size	[mm]	10		
Connection	2, 4	M5/M7 in manifold rail		
Product weight	[g]	55	45	57
Corrosion resistance class CRC <sup>2)</sup>		0		
Certificate-issuing authority		UL MH19482		
Certification		c UL us - Recognized (OL)		

1) C = normally closed

2) More information: [www.festo.com/x/topic/kbk](http://www.festo.com/x/topic/kbk)

### Safety characteristics

Max. positive test pulse with 0 signal	[µs]	1600
Max. negative test pulse with 1 signal	[µs]	3000
Shock resistance		Shock test with severity level 1 to FN 942017-5 and EN 60068-2-27
Vibration resistance		Transport application test with severity level 1 to FN 942017-4 and EN 60068-2-6

## Datasheet

Operating and environmental conditions			
Valve function		T32-A <sup>1)</sup>	M52-A <sup>1)</sup>   B52
Operating medium	Compressed air to ISO 8573-1:2010 [7:4:4]		
Note on the operating/pilot medium	Lubricated operation possible (in which case lubricated operation will always be required)		
Operating pressure	[MPa]	0.15 ... 0.7	0.25 ... 0.7   0.15 ... 0.7
	[bar]	1.5 ... 7	2.5 ... 7   1.5 ... 7
Ambient temperature	[°C]	-5 ... +50	
Temperature of medium	[°C]	-5 ... +50	

1) Pneumatic spring

Electrical data	
Electrical connection	Via E-box → page 110
Operating voltage	[V DC] 24 ±10%
Nominal operating voltage	[V DC] 22
Power	[W] 0.7
Duty cycle	[%] 100
Degree of protection to EN 60529	IP40 (with plug socket), IP65 (with M8)
Signal status indication	LED
Maximum switching frequency	[Hz] 2

Information on materials	
Housing	Wrought aluminium alloy
Seals	HNBR, NBR
Note on materials	RoHS-compliant
PWIS conformity	VDMA24364 zone III

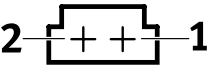
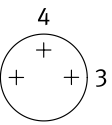
Pin allocation for E-box			Pin	Description
<b>Rectangular plug, connection pattern H</b>				
	1	+ or -		Protective circuit without holding current reduction
	2	+ or -		
<b>Round plug, M8, 3-pin</b>				
	1	Not used		Protective circuit without holding current reduction
	3	+ or -		
	4	+ or -		

### Protective circuit without holding current reduction

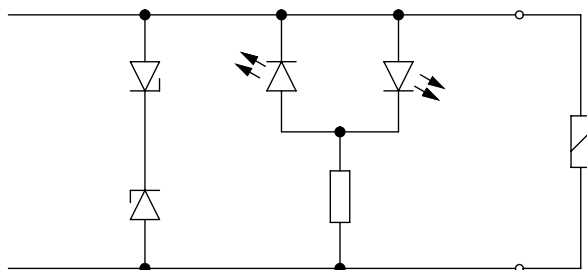

The solenoid coils have a protective circuit to arrest sparks and protect against polarity reversal.

Datasheet

Dimensions

2x 3/2-way, 5/2-way valve, double solenoid

5/2-way valve, single solenoid

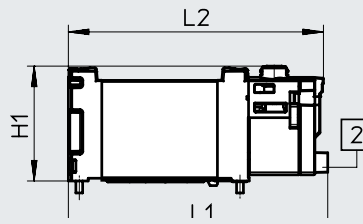
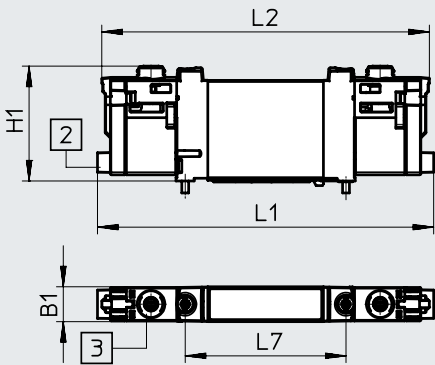

[2] Horizontal electrical connection    [3] Manual override

Download CAD data → [www.festo.com](http://www.festo.com)

**Note**  
 More dimensions  
 E-boxes  
 → Page 112

Type	B1	H1	L1	L2	L7
VUVG-BK10-T32C...	10.2	33.6	98.3	95.8	47
VUVG-BK10-B52...					
VUVG-BK10-M52...			75.9	74.6	

Ordering data



★ Core Range

Ordering data	Description	Part no.	Type	
<b>Sub-base valve M5/M7, with E-box R8</b>				
	<b>2x 3/2-way valve</b>			
	Internal pilot air supply	Normally closed, pneumatic spring return	★ 8042558	VUVG-BK10-T32C-AT-F-1R8L-S
	<b>5/2-way valve, single solenoid</b>			
	Internal pilot air supply	Pneumatic spring return	★ 8042559	VUVG-BK10-M52-AT-F-1R8L-S
	<b>5/2-way valve, double solenoid</b>			
	Internal pilot air supply		★ 8042560	VUVG-BK10-B52-T-F-1R8L-S
<b>Sub-base valve M5/M7, with E-box H2</b>				
	<b>2x 3/2-way valve</b>			
	Internal pilot air supply	Normally closed, pneumatic spring return	★ 8042554	VUVG-BK10-T32C-AT-F-1H2L-S
	<b>5/2-way valve, single solenoid</b>			
	Internal pilot air supply	Pneumatic spring return	★ 8042555	VUVG-BK10-M52-AT-F-1H2L-S
	<b>5/2-way valve, double solenoid</b>			
	Internal pilot air supply		★ 8042556	VUVG-BK10-B52-T-F-1H2L-S

## Datasheet

**Function**

2x 3/2C, 2x 3/2U, 2x 3/2H  
 5/2-way, single solenoid  
 5/2-way, double solenoid valve  
 5/3C, 5/3U, 5/3E

-  - Size 10 mm
-  - Flow rate  
120 ... 330 l/min
-  - Voltage  
5, 12 and 24 V DC



Circuit symbols → page 14

**General technical data VUVG-B**

Valve function	T32-A			T32-M			M52-R	B52	M52-M	P53			
Normal position	C <sup>1)</sup>	U <sup>2)</sup>	H <sup>4)</sup>	C <sup>1)</sup>	U <sup>2)</sup>	H <sup>4)</sup>	–	–	–	C <sup>1)</sup>	U <sup>2)</sup>	E <sup>3)</sup>	
Stable position	Monostable							Bistable	Monostable	Monostable			
Pneumatic spring return	Yes			No			Yes <sup>5)</sup>	–	No	–			
Mechanical spring return	No			Yes			Yes <sup>5)</sup>	–	Yes	Yes			
Vacuum operation at port 1	No			Only with external pilot air supply									
Design	Piston spool												
Sealing principle	Soft												
Actuation type	Electrical												
Type of control	Piloted												
Pilot air supply	External, internal; can be selected via sub-base												
Exhaust function	Can be throttled												
Manual override	Choice of non-detenting, covered, non-detenting/detenting or detenting												
Type of mounting	On manifold rail												
Mounting position	Any												
Nominal width	[mm]	2.7			1.8	1.7		4		2.3		3.5	
Standard nominal flow rate	[l/min]	170			150	140	140		330		285	300	
Flow rate on manifold rail M5	[l/min]	150			130	120	120		210		180	200	
Flow rate on manifold rail M7	[l/min]	160			140	130	130		270		230	250	
Switching time on/off	[ms]	6/15			8/11			7/17		–	8/24		11/30
Changeover time	[ms]	–							7		14		
Size	[mm]	10											
Connection	1, 3, 5	G1/8 in manifold rail											
	2, 4	M5 or M7 in manifold rail											
	12/14, 82/84	M5 in manifold rail											
Product weight	[g]	55			54		45	55	44	55			
Certification	c UL us - Recognized (OL)												
	RCM												
CE marking (see declaration of conformity) <sup>6)</sup>	To EU EMC Directive												
Corrosion resistance class CRC <sup>7)</sup>	2												

1) C=Normally closed/mid-position closed  
 2) U=Normally open/mid-position pressurised  
 3) E=Mid-position exhausted  
 4) H=2x 3/2-way valve in one housing with 1x normally closed and 1x normally open  
 5) Combined reset method  
 6) For information about the area of use, see the EC declaration of conformity at: [www.festo.com/catalogue/...](http://www.festo.com/catalogue/...) → Support/Downloads.  
 If the devices are subject to usage restrictions in residential, commercial or light-industrial environments, further measures for the reduction of the emitted interference may be necessary.  
 7) More information: [www.festo.com/x/topic/kbk](http://www.festo.com/x/topic/kbk)

## Datasheet

Operating and environmental conditions			T32-A <sup>1)</sup>	T32-M <sup>3)</sup>	M52-R <sup>2)</sup>	B52	M52-M <sup>3)</sup>	P53	
Valve function			Compressed air to ISO 8573-1:2010 [7:4:4]						
Operating pressure	Internal	[MPa]	0.15 ... 0.8	0.25 ... 0.8	0.25 ... 0.8	0.15 ... 0.8	0.3 ... 0.8		
		[bar]	1.5 ... 8	2.5 ... 8	2.5 ... 8	1.5 ... 8	3 ... 8		
	External	[MPa]	0.15 ... 1	-0.09 ... 1				-0.09 ... 0.8	-0.09 ... 1
		[bar]	1.5 ... 10	-0.9 ... 10				-0.9 ... 8	-0.9 ... 10
Pilot pressure	[MPa]	0.15 ... 0.8	0.2 ... 0.8	0.25 ... 0.8	0.15 ... 0.8	0.3 ... 0.8			
	[bar]	1.5 ... 8	2 ... 8	2.5 ... 8	1.5 ... 8	3 ... 8			
Ambient temperature		[°C]	-5 ... +50, with holding current reduction -5 ... +60						
Temperature of medium		[°C]	-5 ... +50, with holding current reduction -5 ... +60						

- 1) Pneumatic spring  
 2) Mixed, pneumatic/mechanical spring  
 3) Mechanical spring

Electrical data	
Electrical connection	Via E-box → page 110
Operating voltage	[V DC] 5, 12 and 24 ±10%
Power	[W] 1, reduced to 0.35 with holding current reduction
Duty cycle	[%] 100
Degree of protection to EN 60529	IP40 (with plug socket), IP65 (with M8)

Information on materials	
Housing	Wrought aluminium alloy
Seals	HNBR, NBR
Note on materials	RoHS-compliant
PWIS conformity	VDMA24364-B1/B2-L

### Dimensions

2x 3/2-way, 5/2-way and 5/3-way valve

Download CAD data → [www.festo.com](http://www.festo.com)

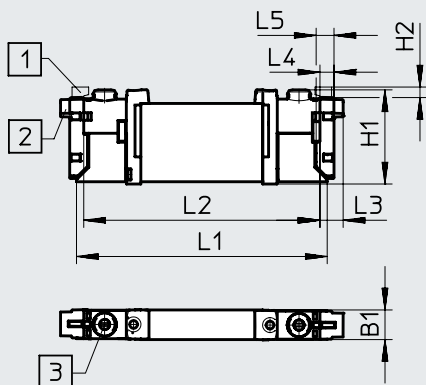

- [1] Vertical electrical connection    [2] Horizontal electrical connection    [3] Manual override

 **Note**  
 More dimensions  
 E-boxes  
 → Page 112

Type	B1	H1	H2	L1	L2	L3	L4	L5	L6	L7
VUVG-B10 -...-F...	10.2	32.5	3.6	86.5	81.5	8	4.85	6.15	69.2	66.7

## Ordering data

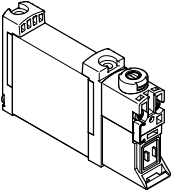
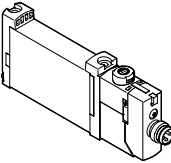
Ordering data	Description	Part no.	Type	
<b>Sub-base valve M5/M7, without E-box</b>				
	<b>2x 3/2-way valve</b>			
	External pilot air supply	Normally closed, pneumatic spring return	566487	VUVG-B10-T32C-AZT-F-1P3
		Normally open, pneumatic spring return	566488	VUVG-B10-T32U-AZT-F-1P3
		1x normally open, 1x normally closed, pneumatic spring return	566489	VUVG-B10-T32H-AZT-F-1P3
		Normally closed, mechanical spring return	574364	VUVG-B10-T32C-MZT-F-1P3
		Normally open, mechanical spring return	574365	VUVG-B10-T32U-MZT-F-1P3
		1x normally open, 1x normally closed, mechanical spring return	574366	VUVG-B10-T32H-MZT-F-1P3
	<b>5/2-way valve, single solenoid</b>			
	External pilot air supply	Pneumatic/mechanical spring return	566490	VUVG-B10-M52-RZT-F-1P3
		Mechanical spring return	574367	VUVG-B10-M52-MZT-F-1P3
	<b>5/2-way valve, double solenoid</b>			
	External pilot air supply		566491	VUVG-B10-B52-ZT-F-1P3
	<b>5/3-way valve</b>			
	External pilot air supply	Mid-position closed, mechanical spring return	566492	VUVG-B10-P53C-ZT-F-1P3
Mid-position exhausted, mechanical spring return		566493	VUVG-B10-P53E-ZT-F-1P3	
Mid-position pressurised, mechanical spring return		566494	VUVG-B10-P53U-ZT-F-1P3	
<b>Sub-base valve M5/M7, with E-box R8</b>				
	<b>2x 3/2-way valve</b>			
	External pilot air supply	Normally closed, pneumatic spring return	574234	VUVG-B10-T32C-AZT-F-1R8L
		Normally open, pneumatic spring return	574235	VUVG-B10-T32U-AZT-F-1R8L
		1x normally open, 1x normally closed, pneumatic spring return	574236	VUVG-B10-T32H-AZT-F-1R8L
		Normally closed, mechanical spring return	8031492	VUVG-B10-T32C-MZT-F-1R8L
		Normally open, mechanical spring return	8031493	VUVG-B10-T32U-MZT-F-1R8L
		1x normally open, 1x normally closed, mechanical spring return	8031494	VUVG-B10-T32H-MZT-F-1R8L
	<b>5/2-way valve, single solenoid</b>			
	External pilot air supply	Pneumatic/mechanical spring return	574237	VUVG-B10-M52-RZT-F-1R8L
		Mechanical spring return	578157	VUVG-B10-M52-MZT-F-1R8L
	<b>5/2-way valve, double solenoid</b>			
	External pilot air supply		574238	VUVG-B10-B52-ZT-F-1R8L
	<b>5/3-way valve</b>			
	External pilot air supply	Mid-position closed, mechanical spring return	574239	VUVG-B10-P53C-ZT-F-1R8L
Mid-position exhausted, mechanical spring return		574241	VUVG-B10-P53E-ZT-F-1R8L	
Mid-position pressurised, mechanical spring return		574240	VUVG-B10-P53U-ZT-F-1R8L	



## Manifold assembly

Sub-base valve for manifold assembly  
M5 or M7 connection



### Dimensions

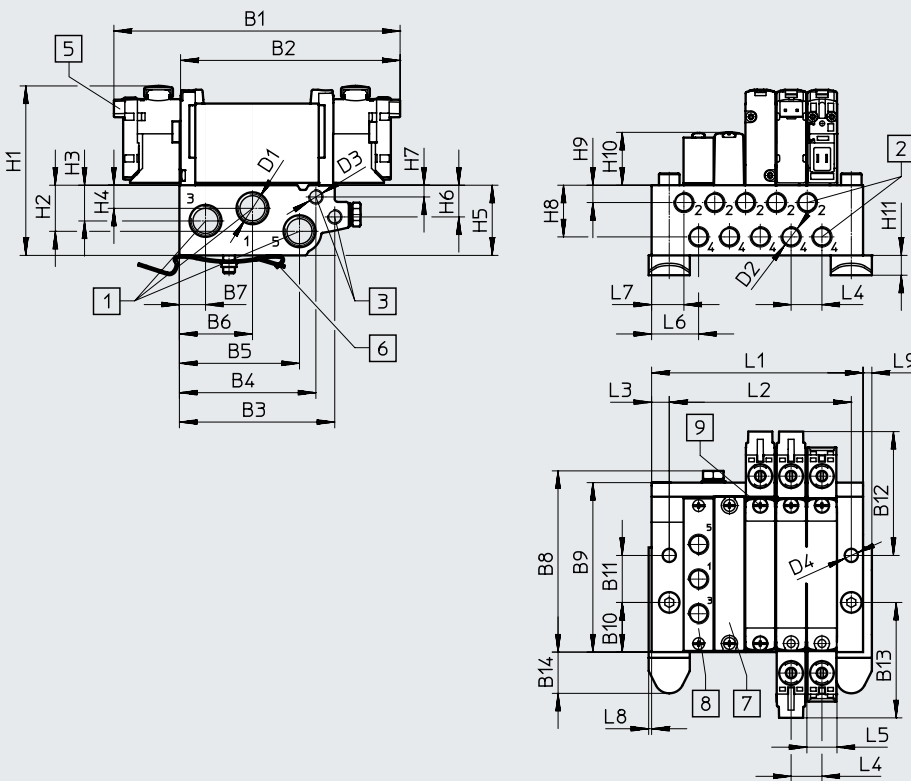

Download CAD data → [www.festo.com](http://www.festo.com)

**Note**  
More dimensions  
E-boxes  
→ Page 112

- [1] Ports 1, 3 and 5: G1/8 (at both ends)
- [2] Ports 2, 4: M7 or M5
- [3] Ports 12, 14: M5
- [5] Electrical connection for E-boxes and accessories
- [6] H-rail mounting (two M4x30 screws are required for mounting)
- [7] Cover plate
- [8] Supply plate, ports 1, 3 and 5: either M5 or M7
- [9] Valves/cover plate mounting on manifold rail: M2 thread

Type	B1	B2	B3	B4	B5	B6	B7	B8	B9	B10	B11	B12
VABM-L1 10....-G18	97.5	74.8	52.9	46.5	40.9	24.9	8.9	61.7	57.7	16.9	16	42.2

Type	B13	B14	D1	D2	D3	D4	D5	H1	H2	H3	H4
VABM-L1 10....-G18	39.3	14.1	G1/8	M5/M7	M5	4.5	∅6	56.4	15.7	12.2	7.9

Type	H5	H6	H7	H8	H9	H10	H11	L3	L4	L5	L6	L7	L8	L9
VABM-L1 10....-G18	23.9	10.8	4	17.6	5.9	18	6.8	6	10.5	10.3	16	11.9	1	3

Valve positions	2	3	4	5	6	7	8	9	10	12	14	16	22
L1	40.5	51	61.5	72	82.5	93	103.5	114	124.5	145.5	166.5	187.5	250.5
L2	30.5	41	51.5	62	72.5	83	93.5	104	114.5	135.5	156.5	177.5	240.5
Weight of VABM [g]	107	135	163	191	219	247	275	303	331	387	415	471	499

## Manifold assembly

### Technical data – Manifold rails<sup>1)</sup>

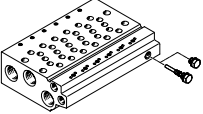
	Connection			KBK	Material <sup>3)</sup>	Operating pressure		Max. tightening torque for assembly [Nm]		
	2, 4	1, 3, 5	12/14, 82/84			[MPa]	[bar]	Valve	H-rail	Wall
	M5 or M7	G1/8	M5	2 <sup>2)</sup>	Wrought aluminium alloy	-0.09 ... 1	-0.9 ... 10	0.45	1.5	3

1) Blanking plugs are included with the manifold rail.



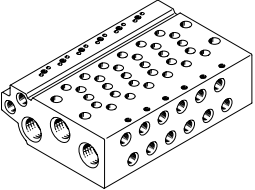

2) More information: [www.festo.com/x/topic/kbk](http://www.festo.com/x/topic/kbk)

3) Information on materials: RoHS-compliant.

### Ordering data – Manifold rails

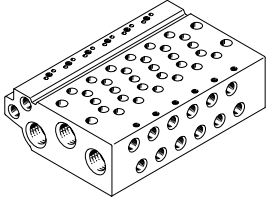
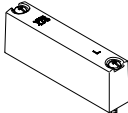

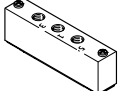
	Description	Part no.	Type
<b>Manifold rail for sub-base valve M5/M7</b>			
	For size B10 (M5)	2 valve positions	★ 566582 VABM-L1-10W-G18-2
		3 valve positions	★ 566583 VABM-L1-10W-G18-3
		4 valve positions	★ 566584 VABM-L1-10W-G18-4
		5 valve positions	566585 VABM-L1-10W-G18-5
		6 valve positions	★ 566586 VABM-L1-10W-G18-6
		7 valve positions	566587 VABM-L1-10W-G18-7
		8 valve positions	★ 566588 VABM-L1-10W-G18-8
		9 valve positions	566589 VABM-L1-10W-G18-9
		10 valve positions	★ 566590 VABM-L1-10W-G18-10
		12 valve positions	566591 VABM-L1-10W-G18-12
		14 valve positions	566592 VABM-L1-10W-G18-14
16 valve positions	566593 VABM-L1-10W-G18-16		

## Manifold assembly

Ordering data – Accessories		Description	Part no.	Type	
<b>Manifold rail for sub-base valve M5/M7</b>					
	For size B10 (M7)	2 valve positions	★ 566606	VABM-L1-10HW-G18-2	
		3 valve positions	★ 566607	VABM-L1-10HW-G18-3	
		4 valve positions	★ 566608	VABM-L1-10HW-G18-4	
		5 valve positions	566609	VABM-L1-10HW-G18-5	
		6 valve positions	★ 566610	VABM-L1-10HW-G18-6	
		7 valve positions	566611	VABM-L1-10HW-G18-7	
		8 valve positions	★ 566612	VABM-L1-10HW-G18-8	
		9 valve positions	566613	VABM-L1-10HW-G18-9	
		10 valve positions	★ 566614	VABM-L1-10HW-G18-10	
		12 valve positions	566615	VABM-L1-10HW-G18-12	
		14 valve positions	566616	VABM-L1-10HW-G18-14	
16 valve positions	566617	VABM-L1-10HW-G18-16			
<b>Cover plate</b> <span style="float: right;">Datasheets → Internet: vabb</span>					
	For valve position on manifold rail, including screws and seal		★ 566495	VABB-L1-10-W	
<b>Separator</b> <span style="float: right;">Datasheets → Internet: vabd</span>					
	For creating pressure zones		569994	VABD-6-B	
<b>Supply plate</b> <span style="float: right;">Datasheets → Internet: vabf</span>					
	For valve position (sub-base valves M5) on manifold rail, including screws and seal		569991	VABF-L1-10-P3A4-M5	
	For valve position (sub-base valves M7) on manifold rail, including screws and seal		569992	VABF-L1-10-P3A4-M7	
<b>Seals</b> <span style="float: right;">Datasheets → Internet: vabd</span>					
	Only suitable for VUVG-B10	For sub-base valves M5/M7	Delivery quantity: 10 sets (each with 2 screws and 1 seal)	566674	VABD-L1-10B-S-M7

## Datasheet

Function  
2x 3/2C  
5/2-way, single solenoid  
5/2-way, double solenoid valve

-  - Size 14 mm
-  - Flow rate  
350 ... 380 l/min
-  - Voltage  
24 V DC

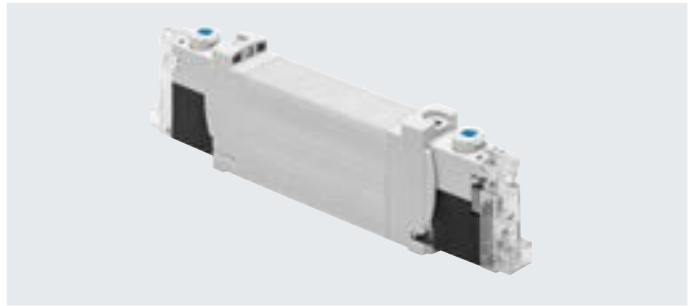

Circuit symbols → page 14

### General technical data VUVG-BK

Valve function	T32-A	M52-A	B52
Normal position	C <sup>1)</sup>	-	-
Stable position	Monostable		Bistable
Pneumatic spring return	Yes	Yes	-
Design	Piston spool		
Sealing principle	Soft		
Actuation type	Electrical		
Type of control	Piloted		
Pilot air supply	Internal		
Exhaust function	Can be throttled		
Manual override	Non-detenting, detenting		
Type of mounting	On manifold rail		
Mounting position	Any		
Standard nominal flow rate	[l/min]	350	380
Switching time on/off	[ms]	13/20	14/24
Changeover time	[ms]	-	8
Size	[mm]	14	
Connection	2, 4	G1/8 in manifold rail	
Product weight	[g]	75	85
Corrosion resistance class CRC <sup>2)</sup>	0		
Certificate-issuing authority	UL MH19482		
Certification	c UL us - Recognized (OL)		

1) C = normally closed

2)

More information: [www.festo.com/x/topic/kbk](http://www.festo.com/x/topic/kbk)

### Safety characteristics

Max. positive test pulse with 0 signal	[μs]	1600
Max. negative test pulse with 1 signal	[μs]	3000
Shock resistance	Shock test with severity level 1 to FN 942017-5 and EN 60068-2-27	
Vibration resistance	Transport application test with severity level 1 to FN 942017-4 and EN 60068-2-6	

## Datasheet

Operating and environmental conditions				
Valve function		T32-A <sup>1)</sup>	M52-A <sup>1)</sup>	B52
Operating medium	Compressed air to ISO 8573-1:2010 [7:4:4]			
Note on the operating/pilot medium	Lubricated operation possible (in which case lubricated operation will always be required)			
Operating pressure	[MPa]	0.15 ... 0.7	0.25 ... 0.7	0.15 ... 0.7
	[bar]	1.5 ... 7	2.5 ... 7	1.5 ... 7
Ambient temperature	[°C]	-5 ... +50		
Temperature of medium	[°C]	-5 ... +50		

1) Pneumatic spring

Electrical data	
Electrical connection	Via E-box → page 110
Operating voltage	[V DC] 24 ±10%
Nominal operating voltage	[V DC] 22
Power	[W] 0.7
Duty cycle	[%] 100
Degree of protection to EN 60529	IP40 (with plug socket), IP65 (with M8)
Signal status indication	LED
Maximum switching frequency	[Hz] 2

Information on materials	
Housing	Wrought aluminium alloy
Seals	HNBR, NBR
Note on materials	RoHS-compliant
PWIS conformity	VDMA24364 zone III

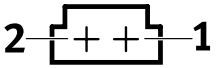
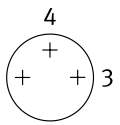
Pin allocation for E-box			
	Pin		Description
<b>Rectangular plug, connection pattern H</b>			
	1	+ or -	Protective circuit without holding current reduction
	2	+ or -	
<b>Round plug, M8, 3-pin</b>			
	1	Not used	Protective circuit without holding current reduction
	3	+ or -	
	4	+ or -	

### Protective circuit without holding current reduction

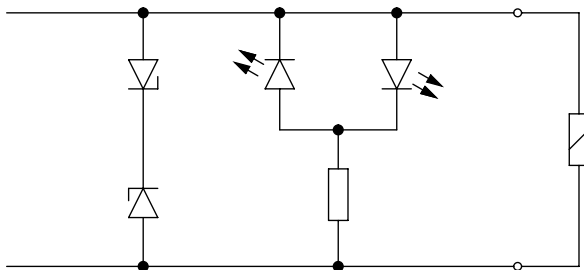

The solenoid coils have a protective circuit to arrest sparks and protect against polarity reversal.

## Datasheet

### Dimensions

Download CAD data → [www.festo.com](http://www.festo.com)

2x 3/2-way, 5/2-way valve, single solenoid

5/2-way valve, double solenoid

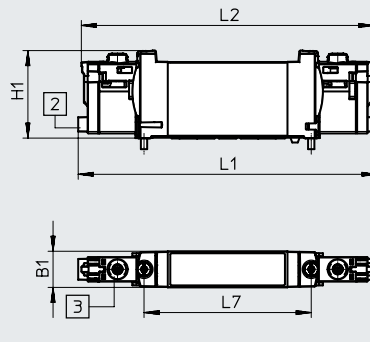
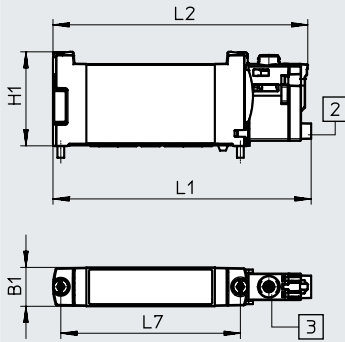

**Note**  
More dimensions  
E-boxes  
→ Page 112

[2] Horizontal electrical connection

[3] Manual override

Type	B1	H1	L1	L2	L7
VUVG-BK14-T32C...	14.4	34.8	118.9	116.4	66.5
VUVG-BK14-B52...					
VUVG-BK14-M52...			95.6	94.4	

## Ordering data

### ★ Core Range





Ordering data	Description	Part no.	Type
<b>Sub-base valve G1/8, with E-box R8</b>			
	<b>2x 3/2-way valve</b>		
	Internal pilot air supply	Normally closed, pneumatic spring return	★ 8042574 VUVG-BK14-T32C-AT-F-1R8L-S
	<b>5/2-way valve, single solenoid</b>		
	Internal pilot air supply	Pneumatic spring return	★ 8042575 VUVG-BK14-M52-AT-F-1R8L-S
	<b>5/2-way valve, double solenoid</b>		
	Internal pilot air supply		★ 8042576 VUVG-BK14-B52-T-F-1R8L-S
	<b>Sub-base valve G1/8, with E-box H2</b>		
	<b>2x 3/2-way valve</b>		
	Internal pilot air supply	Normally closed, pneumatic spring return	★ 8042570 VUVG-BK14-T32C-AT-F-1H2L-S
	<b>5/2-way valve, single solenoid</b>		
	Internal pilot air supply	Pneumatic spring return	★ 8042571 VUVG-BK14-M52-AT-F-1H2L-S
	<b>5/2-way valve, double solenoid</b>		
	Internal pilot air supply		★ 8042572 VUVG-BK14-B52-T-F-1H2L-S

## Datasheet

### Function

2x 3/2C, 2x 3/2U, 2x 3/2H  
 5/2-way, single solenoid  
 5/2-way, double solenoid valve  
 5/3C, 5/3U, 5/3E

Circuit symbols → page 14

-  - Size 14 mm
-  - Flow rate  
410 ... 680 l/min
-  - Voltage  
5, 12 and 24 V DC  
24, 110 and 230 V AC
-  - Voltage VUVG-...-P1  
12 and 24 V DC  
24, 110 and 230 V AC



General technical data VUVG-B																	
Valve function		T32-A			T32-M			M52-A	B52	M52-M	P53						
Normal position		C <sup>1)</sup>	U <sup>2)</sup>	H <sup>4)</sup>	C <sup>1)</sup>	U <sup>2)</sup>	H <sup>4)</sup>	–	–	–	C <sup>1)</sup>	U <sup>2)</sup>	E <sup>3)</sup>				
Stable position		Monostable							Bistable	Monostable	Monostable						
Pneumatic spring return		Yes			No			Yes	–	No	–						
Mechanical spring return		No			Yes			No	–	Yes	Yes						
Vacuum operation at port 1		No			Only with external pilot air supply												
Size [mm]		14															
Design		Piston spool															
Sealing principle		Soft															
Actuation type		Electrical															
Type of control		Piloted															
Pilot air supply		External, internal; can be selected via sub-base															
Exhaust function		Can be throttled															
Manual override		VUVG-...		Choice of non-detenting, covered, non-detenting/detenting or detenting													
		VUVG-...-P1		Non-detenting, non-detenting/detenting													
Type of mounting		On manifold rail															
Mounting position		Any															
Nominal width [mm]		4.6			4.3			5.6									
Standard nominal flow rate [l/min]		600   580			470   450			630		680		630		600   580   580			
Flow rate on manifold rail G1/8 [l/min]		510			430   410			520		570		520		500   460			
<b>Switching time</b>																	
VUVG-...		On/off [ms]		9/25			12/18			14/22		–		13/37		12/40	
		Changeover [ms]		–							8		20				
Pneumatic connection		1, 3, 5		G1/4 in manifold rail													
		2, 4		G1/8 in manifold rail													
		12/14, 82/84		M5 in manifold rail													
Product weight		VUVG-... [g]		89			80			78		89		70		89	
		VUVG-...-P1 [g]		65			56			66		65		58		65	
Certificate-issuing authority		VUVG-...-P1		UL MH19482													
Certification		VUVG-...		RCM mark													
		VUVG-...		c UL us - Recognized (OL)													
		VUVG-...-P1															
CE marking (see declaration of conformity) <sup>5)</sup>		To EU EMC Directive															
		To EU Low Voltage Directive															
Corrosion resistance class CRC <sup>6)</sup>		2															

1) C=Normally closed/mid-position closed

2) U=Normally open/mid-position pressurised

3) E=Mid-position exhausted

4) H=2x 3/2-way valve in one housing with 1x normally closed and 1x normally open

5) For information about the area of use, see the EC declaration of conformity at: [www.festo.com/catalogue/...](http://www.festo.com/catalogue/...) → Support/Downloads.

If the devices are subject to usage restrictions in residential, commercial or light-industrial environments, further measures for the reduction of the emitted interference may be necessary.

6)

More information: [www.festo.com/x/topic/kbk](http://www.festo.com/x/topic/kbk)

## Datasheet

Operating and environmental conditions			T32-A <sup>1)</sup>	T32-M <sup>2)</sup>	M52-A <sup>1)</sup>	B52	M52-M <sup>2)</sup>	P53	
Valve function			Compressed air to ISO 8573-1:2010 [7:4:4]						
Note on the operating/pilot medium			Lubricated operation possible (in which case lubricated operation will always be required)						
Operating pressure	Internal VUVG-...	[MPa]	0.15 ... 0.8	0.35 ... 0.8	0.25 ... 0.8	0.15 ... 0.8	0.3 ... 0.8		
		[bar]	1.5 ... 8	3.5 ... 8	2.5 ... 8	1.5 ... 8	3 ... 8		
	External	[MPa]	0.15 ... 1	-0.09 ... 1				-0.09 ... 0.8	-0.09 ... 1
		[bar]	1.5 ... 10	-0.9 ... 10				-0.9 ... 8	-0.9 ... 10
Pilot pressure <sup>3)</sup>		[MPa]	0.15 ... 0.8	0.3 ... 0.8	0.25 ... 0.8	0.15 ... 0.8	0.3 ... 0.8		
		[bar]	1.5 ... 8	3 ... 8	2.5 ... 8	1.5 ... 8	3 ... 8		
Ambient temperature	VUVG-...	[°C]	-5 ... +50, with holding current reduction -5 ... +60						
Temperature of medium	VUVG-...	[°C]	-5 ... +50, with holding current reduction -5 ... +60						

1) Pneumatic spring

2) Mechanical spring

3) Minimum pilot pressure 50% of operating pressure

## Electrical data

Electrical connection	VUVG-...		Via E-box → page 110					
Operating voltage	VUVG-...	[V DC]	5, 12 and 24 ±10%					
Power	VUVG-...	[W]	1, reduced to 0.35 with holding current reduction					
Duty cycle		[%]	100					
Degree of protection to EN 60529								
	VUVG-...		IP40 (with plug socket), IP65 (with M8)					

## Information on materials

Housing	Wrought aluminium alloy						
Seals	HNBR, NBR						
Note on materials	RoHS-compliant						
PWIS conformity	VDMA24364-B1/B2-L						



Datasheet

**Dimensions VUVG**

Download CAD data → [www.festo.com](http://www.festo.com)

2x 3/2-way, 5/2-way and 5/3-way valve

5/2-way valve, single solenoid

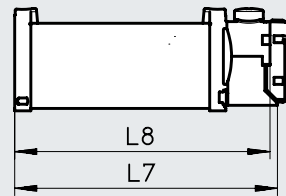
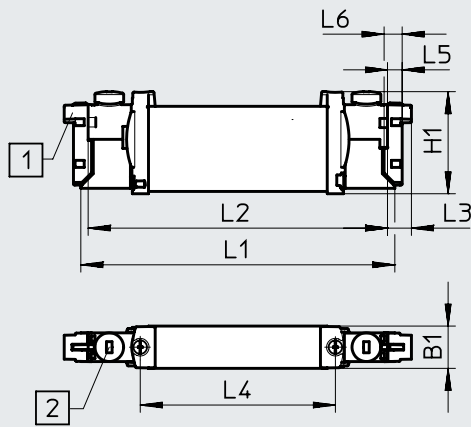

**Note**  
 More dimensions  
 E-boxes  
 → Page 112

[1] Horizontal electrical connection    [2] Manual override

Type	B1	H1	L1	L2	L3	L4	L5	L6	L7	L8
VUVG-B14-...-F...	14	34.8	107	102	8	66.5	4.9	6.2	89.5	87

**Dimensions VUVG-...-P1**

2x 3/2-way, 5/2-way and 5/3-way valve

5/2-way valve, single solenoid

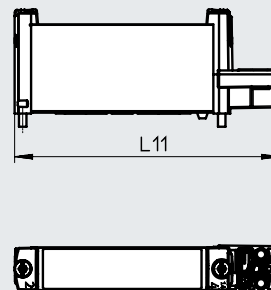
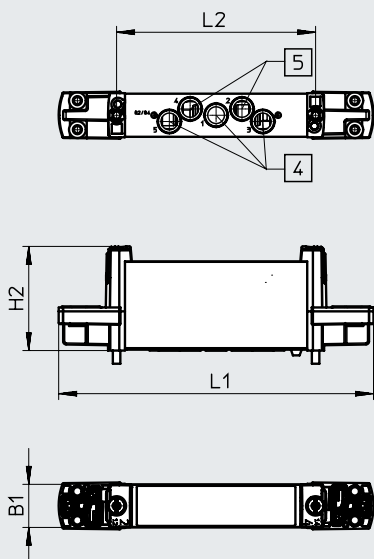

[4] Connections 1, 3 and 5

[5] Connections 2 and 4

Type	B1	H2	L1	L2	L11
VUVG-B14-...-P1	14.4	34.8	105.2	66.5	88.6

## Ordering data

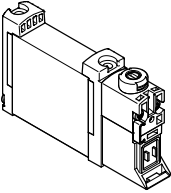
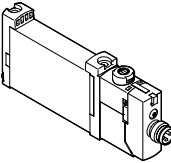
Ordering data	Description	Part no.	Type	
<b>Sub-base valve G1/8, without E-box</b>				
	<b>2x 3/2-way valve</b>			
	External pilot air supply	Normally closed, pneumatic spring return	566513	VUVG-B14-T32C-AZT-F-1P3
		Normally open, pneumatic spring return	566514	VUVG-B14-T32U-AZT-F-1P3
		1x normally open, 1x normally closed, pneumatic spring return	566515	VUVG-B14-T32H-AZT-F-1P3
		Normally closed, mechanical spring return	574376	VUVG-B14-T32C-MZT-F-1P3
		Normally open, mechanical spring return	574377	VUVG-B14-T32U-MZT-F-1P3
		1x normally open, 1x normally closed, mechanical spring return	574378	VUVG-B14-T32H-MZT-F-1P3
	<b>5/2-way valve, single solenoid</b>			
	External pilot air supply	Pneumatic spring return	566516	VUVG-B14-M52-AZT-F-1P3
		Mechanical spring return	574379	VUVG-B14-M52-MZT-F-1P3
	<b>5/2-way valve, double solenoid</b>			
	External pilot air supply		566517	VUVG-B14-B52-ZT-F-1P3
	<b>5/3-way valve</b>			
	External pilot air supply	Mid-position closed, mechanical spring return	566518	VUVG-B14-P53C-ZT-F-1P3
Mid-position exhausted, mechanical spring return		566519	VUVG-B14-P53E-ZT-F-1P3	
Mid-position pressurised, mechanical spring return		566520	VUVG-B14-P53U-ZT-F-1P3	
<b>Sub-base valve G1/8, with E-box R8</b>				
	<b>2x 3/2-way valve</b>			
	External pilot air supply	Normally closed, pneumatic spring return	574242	VUVG-B14-T32C-AZT-F-1R8L
		Normally open, pneumatic spring return	574243	VUVG-B14-T32U-AZT-F-1R8L
		1x normally open, 1x normally closed, pneumatic spring return	574244	VUVG-B14-T32H-AZT-F-1R8L
		Normally closed, mechanical spring return	578248	VUVG-B14-T32C-MZT-F-1R8L
		Normally open, mechanical spring return	8031517	VUVG-B14-T32U-MZT-F-1R8L
		1x normally open, 1x normally closed, mechanical spring return	8031518	VUVG-B14-T32H-MZT-F-1R8L
	<b>5/2-way valve, single solenoid</b>			
	External pilot air supply	Pneumatic spring return	574245	VUVG-B14-M52-AZT-F-1R8L
		Mechanical spring return	578158	VUVG-B14-M52-MZT-F-1R8L
	<b>5/2-way valve, double solenoid</b>			
	External pilot air supply		574246	VUVG-B14-B52-ZT-F-1R8L
	<b>5/3-way valve</b>			
	External pilot air supply	Mid-position closed, mechanical spring return	574247	VUVG-B14-P53C-ZT-F-1R8L
Mid-position exhausted, mechanical spring return		574249	VUVG-B14-P53E-ZT-F-1R8L	
Mid-position pressurised, mechanical spring return		574248	VUVG-B14-P53U-ZT-F-1R8L	

## Ordering data

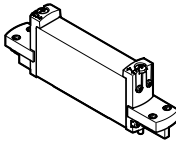
Ordering data				
	Description	Part no.	Type	
<b>Sub-base valve G1/8, to ISO15218</b>				
	<b>2x 3/2-way valve</b>			
	External pilot air supply	Normally closed, pneumatic spring return	8033535	VUVG-B14-T32C-AZ-F-P1
		Normally open, pneumatic spring return	8033536	VUVG-B14-T32U-AZ-F-P1
		1x normally open, 1x normally closed, pneumatic spring return	8033537	VUVG-B14-T32H-AZ-F-P1
		Normally closed, mechanical spring return	8033538	VUVG-B14-T32C-MZ-F-P1
		Normally open, mechanical spring return	8033539	VUVG-B14-T32U-MZ-F-P1
		1x normally open, 1x normally closed, mechanical spring return	8033540	VUVG-B14-T32H-MZ-F-P1
	<b>5/2-way valve, single solenoid</b>			
	External pilot air supply	Pneumatic spring return	8033541	VUVG-B14-M52-AZ-F-P1
		Mechanical spring return	8033542	VUVG-B14-M52-MZ-F-P1
	<b>5/2-way valve, double solenoid</b>			
	External pilot air supply	–	8033543	VUVG-B14-B52-Z-F-P1
	<b>5/3-way valve</b>			
	External pilot air supply	Mid-position closed, mechanical spring return	8033544	VUVG-B14-P53C-Z-F-P1
Mid-position exhausted, mechanical spring return		8033545	VUVG-B14-P53E-Z-F-P1	
Mid-position pressurised, mechanical spring return		8033546	VUVG-B14-P53U-Z-F-P1	

## Manifold assembly

Sub-base valve for manifold assembly  
Connection G1/8



### Dimensions

Download CAD data → [www.festo.com](http://www.festo.com)

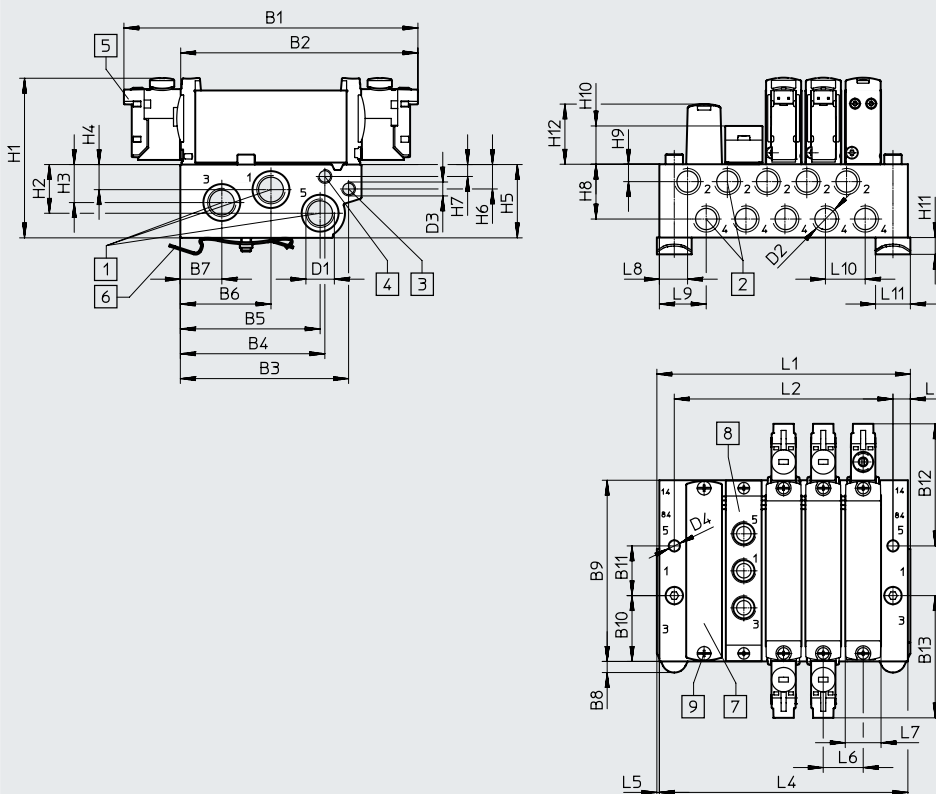

 **Note**  
More dimensions  
E-boxes  
→ Page 112

- |   |   |  |   |
|---|---|--|---|
| [1] Ports 1, 3 and 5: G1/4 (at both ends) | [5] Electrical connection for E-boxes and accessories | [6] H-rail mounting (two M4x35 screws are required for mounting) | [8] Supply plate: ports 1, 3 and 5: G1/8                      |
| [2] Ports 2, 4: G1/8                      |   | [7] Cover plate  | [9] Valves/cover plate mounting on manifold rail: M2.5 thread |
| [3] Ports 12, 14: M5                      |   |  |   |
| [4] Ports 82, 84: M5                      |   |  |   |

Type	B1	B2	B3	B4	B5	B6	B7	B8	B9	B10	B11	B12
VABM-L1-14W-G14	118.3	95.1	67.7	58.2	56.3	36.6	16.7	4.5	72.9	26.5	20	49.1

Type	B13	D1	D2	D3	D4	H1	H2	H3	H4	H5
VABM-L1-14W-G14	49.1	G1/4	G1/8	M5	∅ 4.5	64.3	19.6	15.3	10.1	29.5

Type	H6	H7	H8	H9	H10	H11	H12	L3	L5	L6	L7	L8	L9	L10	L11
VABM-L1-14W-G14	9.8	4.8	22.1	7	15.4	6.8	23.9	6	1	16	14.4	11.3	18.5	16	14

Valve positions	2	3	4	5	6	7	8	9	10	12	14	16
L1	56.3	72.3	88.3	104.3	120.3	136.3	152.3	168.3	184.3	216.3	248.3	280.3
L2	40	56	72	88	104	120	136	152	168	200	232	264
L4	54.3	70.3	86.3	102.3	118.3	134.3	150.3	166.3	182.3	214.3	246.6	278.3
Weight of VABM [g]	232	306	380	454	528	602	676	750	824	972	1120	1268

## Ordering data

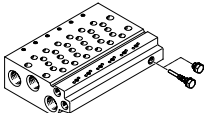

Technical data – Manifold rails <sup>1)</sup>	Connection			KBK	Material <sup>3)</sup>	Operating pressure		Max. tightening torque for assembly [Nm]		
	2, 4	1, 3, 5	12/14, 82/84			[MPa]	[bar]	Valve	H-rail	Wall
		G1/8	G1/4	M5	2 <sup>2)</sup>	Wrought aluminium alloy	-0.09 ... 1	-0.9 ... 10	0.65	1.5

1) Blanking plugs are included with the manifold rail.



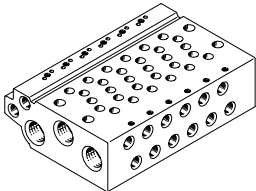

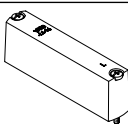
2) More information: [www.festo.com/x/topic/kbk](http://www.festo.com/x/topic/kbk)

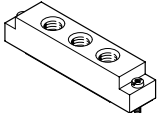
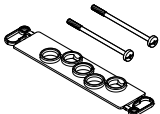
3) Information on materials: RoHS-compliant.

Ordering data – Manifold rail				
	Description	Part no.	Type	
<b>Manifold rail for sub-base valve G1/8</b>				
	For size B14 (G1/8)			
		2 valve positions	★ 566642	VABM-L1-14W-G14-2
		3 valve positions	★ 566643	VABM-L1-14W-G14-3
		4 valve positions	★ 566644	VABM-L1-14W-G14-4
		5 valve positions	566645	VABM-L1-14W-G14-5
		6 valve positions	★ 566646	VABM-L1-14W-G14-6
		7 valve positions	566647	VABM-L1-14W-G14-7
		8 valve positions	★ 566648	VABM-L1-14W-G14-8
		9 valve positions	566649	VABM-L1-14W-G14-9
		10 valve positions	★ 566650	VABM-L1-14W-G14-10
		12 valve positions	566651	VABM-L1-14W-G14-12
	14 valve positions	566652	VABM-L1-14W-G14-14	
	16 valve positions	566653	VABM-L1-14W-G14-16	

Ordering data – Accessories			
	Description	Part no.	Type
<b>Cover plate</b> <span style="float: right;">Datasheets → Internet: vabb</span>			
	For valve position on manifold rail, including screws and seal	–	★ 569989
	Suitable for battery production		8168539
			VABB-L1-14
			VABB-L1-14-F1A
<b>Separator</b> <span style="float: right;">Datasheets → Internet: vabd</span>			
	For creating pressure zones		569996
			VABD-10-B
<b>Supply plate</b> <span style="float: right;">Datasheets → Internet: vabf</span>			
	For valve position on manifold rail, including screws and seal	–	569993
	Suitable for battery production		8163544
			VABF-L1-14-P3A4-G18
			VABF-L1-14-P3A4-G18-F1A
<b>Seals</b> <span style="float: right;">Datasheets → Internet: vabd</span>			
	For sub-base valves G1/8	Delivery quantity: 10 sets (each with 2 screws and 1 seal)	566676
			VABD-L1-14B-S-G18

## Datasheet

Function	-  -	Size 18 mm
2x 3/2C, 2x 3/2U, 2x 3/2H	-  -	Flow rate
5/2-way, single solenoid		800 ... 1150 l/min
5/2-way, double solenoid valve	-  -	Voltage
5/3C, 5/3U, 5/3E		5, 12 and 24 V DC
Circuit symbols → page 14	-  -	Voltage VUVG-...-P1
		12 and 24 V DC
		24, 110 and 230 V AC



General technical data VUVG-B			T32-A			T32-M			M52-R	B52	M52-M	P53			
Valve function			C <sup>1)</sup>	U <sup>2)</sup>	H <sup>4)</sup>	C <sup>1)</sup>	U <sup>2)</sup>	H <sup>4)</sup>	-	-	-	C <sup>1)</sup>	U <sup>2)</sup>	E <sup>3)</sup>	
Normal position			Monostable									Bistable			
Stable position			Monostable									Monostable			
Pneumatic spring return			Yes			No			Yes <sup>5)</sup>	-	No	-			
Mechanical spring return			No			Yes			Yes <sup>5)</sup>	-	Yes	Yes			
Vacuum operation at port 1			No			Only with external pilot air supply									
Design			Piston spool												
Sealing principle			Soft												
Actuation type			Electrical												
Type of control			Piloted												
Pilot air supply			External, internal; can be selected via sub-base												
Exhaust function			Can be throttled												
Manual override	VUVG-...		Choice of non-detenting, covered, non-detenting/detenting or detenting												
	VUVG-...-P1		-												
Type of mounting			On manifold rail												
Mounting position			Any												
Nominal width		[mm]	5.7			6.9			7.3	6.9		6.5			
Standard nominal flow rate		[l/min]	900			1150						1080			
Flow rate on manifold rail			800			1000						950			
<b>Switching time</b>															
VUVG-...	on/off	[ms]	13/27			15/22			15/31	-	10/45		15/48		
	changeover	[ms]	-							11			29		
VUVG-...-P1	on/off	[ms]	13/18			13/27			16/22	-	14/26		15/32		
	changeover	[ms]	-							12	-		21		
Size		[mm]	18												
Connection	1, 3, 5		G3/8 in manifold rail												
	2, 4		G1/4 in manifold rail												
	12/14, 82/84		M5 in manifold rail												
Product weight	VUVG-...	[g]	164			154			160	154		160			
	VUVG-...-P1	[g]	140			142			140	142		136			
Certificate-issuing authority	VUVG-...-P1		UL MH19482												
Certification	VUVG-...		RCM mark												
	VUVG-...		c UL us - Recognized (OL)												
	VUVG-...-P1														
<b>CE marking (see declaration of conformity)<sup>6)</sup></b>															
	VUVG-...		To EU EMC Directive												
	VUVG-...-P1		To EU Low Voltage Directive												
Corrosion resistance class CRC <sup>7)</sup>			2												

1) C=Normally closed/mid-position closed

2) U=Normally open/mid-position pressurised

3) E=Mid-position exhausted

4) H=2x 3/2-way valve in one housing with 1x normally closed and 1x normally open

5) Combined reset method

6) For information about the area of use, see the EC declaration of conformity at: [www.festo.com/catalogue/...](http://www.festo.com/catalogue/...) → Support/Downloads.

If the devices are subject to usage restrictions in residential, commercial or light-industrial environments, further measures for the reduction of the emitted interference may be necessary.

7)

More information: [www.festo.com/x/topic/kbk](http://www.festo.com/x/topic/kbk)

## Datasheet

Operating and environmental conditions			T32-A <sup>1)</sup>	T32-M <sup>3)</sup>	M52-R <sup>2)</sup>	B52	M52-M <sup>3)</sup>	P53
Valve function			Compressed air to ISO 8573-1:2010 [7:4:4]					
Operating pressure	Internal	[MPa]	0.15 ... 0.8	0.3 ... 0.8	0.25 ... 0.8	0.15 ... 0.8	0.3 ... 0.8	
		[bar]	1.5 ... 8	3 ... 8	2.5 ... 8	1.5 ... 8	3 ... 8	
	External	[MPa]	0.15 ... 1	-0.09 ... 1				-0.09 ... 1
		[bar]	1.5 ... 10	-0.9 ... 10				-0.9 ... 10
Pilot pressure		[MPa]	0.15 ... 0.8	0.2 ... 0.8	0.25 ... 0.8	0.15 ... 0.8	0.3 ... 0.8	
		[bar]	1.5 ... 8	2 ... 8	2.5 ... 8	1.5 ... 8	3 ... 8	
Ambient temperature	VUVG-...	[°C]	-5 ... +50, with holding current reduction -5 ... +60					
	VUVG-...-P1	[°C]	-5 ... +60					
Temperature of medium	VUVG-...	[°C]	-5 ... +50, with holding current reduction -5 ... +60					
	VUVG-...-P1	[°C]	-5 ... +60					

- 1) Pneumatic spring  
2) Mixed, pneumatic/mechanical spring  
3) Mechanical spring

Electrical data			
Electrical connection	VUVG-...		Via E-box → page 110
	VUVG-...-P1		Via electric pilot valve
Pilot interface	VUVG-...-P1		To ISO 15218
Operating voltage	VUVG-...	[V DC]	5, 12 and 24 ±10%
		[V DC]	12 and 24 ±10%
		[V AC]	24, 110 and 230 ±10%
Power	VUVG-...	[W]	1, reduced to 0.35 with holding current reduction
	VUVG-...-P1	[W]	1.3
Duty cycle		[%]	100
Degree of protection to EN 60529			
	VUVG-...		IP40 (with plug socket), IP65 (with M8)
	VUVG-...-P1		IP65, with electric pilot valve and plug socket

Information on materials	
Housing	Wrought aluminium alloy
Seals	HNBR, NBR
Note on materials	RoHS-compliant
PWIS conformity	VDMA24364-B1/B2-L

## Dimensions VUVG-B18-...F-...

Download CAD data → [www.festo.com](http://www.festo.com)

2x 3/2-way, 5/2-way and 5/3-way valve

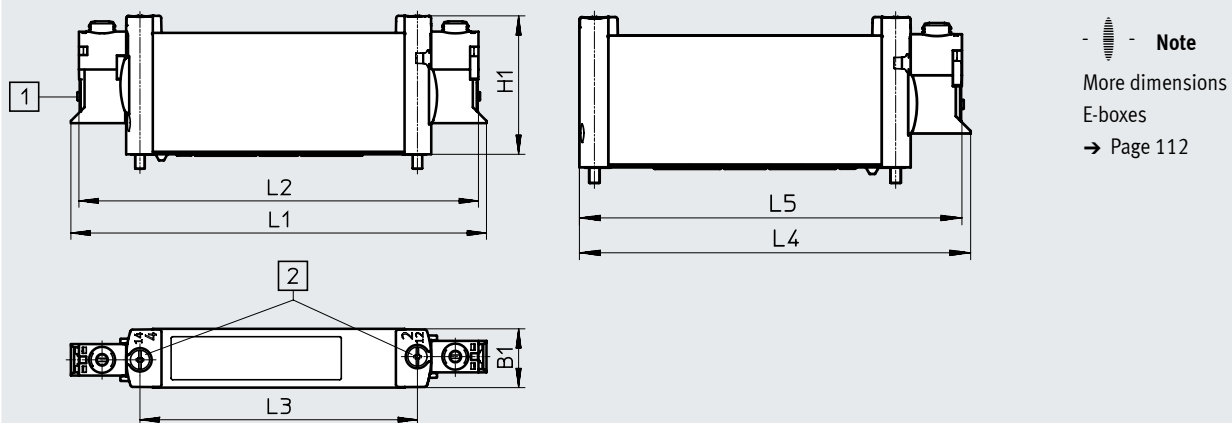

[1] Horizontal electrical connection [2] Manual override

Type	B1	H1	L1	L2	L3	L4	L5
VUVG-B18 -...-F-...	18.3	43.1	129.4	124.4	86.4	112.2	109.7

## Datasheet

### Dimensions VUVG-B18-...-F-P1

Download CAD data → [www.festo.com](http://www.festo.com)

2x 3/2-way, 5/2-way and 5/3-way valve

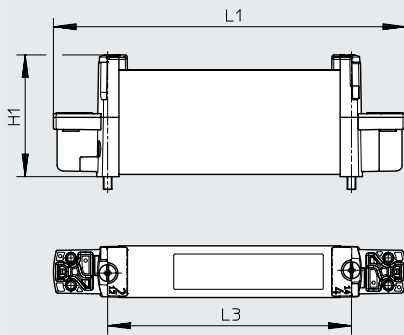

Type	H1	L1	L3
VUVG-B18-...-F-P1	43.1	124.8	86.4

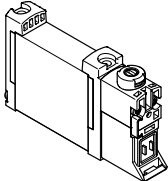
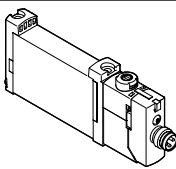

## Ordering data

Ordering data	Description	Part no.	Type	
<b>Sub-base valve G1/4, without E-box</b>				
	<b>2x 3/2-way valve</b>			
	External pilot air supply	Normally closed, pneumatic spring return	574443	VUVG-B18-T32C-AZT-F-1P3
		Normally open, pneumatic spring return	574444	VUVG-B18-T32U-AZT-F-1P3
		1x normally open, 1x normally closed, pneumatic spring return	574445	VUVG-B18-T32H-AZT-F-1P3
		Normally closed, mechanical spring return	574446	VUVG-B18-T32C-MZT-F-1P3
		Normally open, mechanical spring return	574447	VUVG-B18-T32U-MZT-F-1P3
		1x normally open, 1x normally closed, mechanical spring return	574448	VUVG-B18-T32H-MZT-F-1P3
	<b>5/2-way valve, single solenoid</b>			
	External pilot air supply	Pneumatic/mechanical spring return	574449	VUVG-B18-M52-RZT-F-1P3
		Mechanical spring return	574450	VUVG-B18-M52-MZT-F-1P3
	<b>5/2-way valve, double solenoid</b>			
	External pilot air supply		574451	VUVG-B18-B52-ZT-F-1P3
	<b>5/3-way valve</b>			
	External pilot air supply	Mid-position closed, mechanical spring return	574452	VUVG-B18-P53C-ZT-F-1P3
Mid-position exhausted, mechanical spring return		574453	VUVG-B18-P53E-ZT-F-1P3	
Mid-position pressurised, mechanical spring return		574454	VUVG-B18-P53U-ZT-F-1P3	
<b>Sub-base valve G1/4, with E-box R8</b>				
	<b>2x 3/2-way valve</b>			
	External pilot air supply	Normally closed, pneumatic spring return	8031537	VUVG-B18-T32C-AZT-F-1R8L
		Normally open, pneumatic spring return	8031538	VUVG-B18-T32U-AZT-F-1R8L
		1x normally open, 1x normally closed, pneumatic spring return	8031539	VUVG-B18-T32H-AZT-F-1R8L
		Normally closed, mechanical spring return	8031540	VUVG-B18-T32C-MZT-F-1R8L
		Normally open, mechanical spring return	8031541	VUVG-B18-T32U-MZT-F-1R8L
		1x normally open, 1x normally closed, mechanical spring return	8031542	VUVG-B18-T32H-MZT-F-1R8L
	<b>5/2-way valve, single solenoid</b>			
	External pilot air supply	Pneumatic/mechanical spring return	8031543	VUVG-B18-M52-RZT-F-1R8L
		Mechanical spring return	8031544	VUVG-B18-M52-MZT-F-1R8L
	<b>5/2-way valve, double solenoid</b>			
	External pilot air supply		8031545	VUVG-B18-B52-ZT-F-1R8L
	<b>5/3-way valve</b>			
	External pilot air supply	Mid-position closed, mechanical spring return	8031546	VUVG-B18-P53C-ZT-F-1R8L
Mid-position exhausted, mechanical spring return		8031547	VUVG-B18-P53E-ZT-F-1R8L	
Mid-position pressurised, mechanical spring return		8031548	VUVG-B18-P53U-ZT-F-1R8L	

## Ordering data

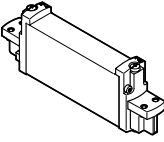
Ordering data		Description	Part no.	Type
<b>Sub-base valve G1/4, to ISO 15218</b>				
	<b>2x 3/2-way valve</b>			
	External pilot air supply	Normally closed, mechanical spring return	8033559	VUVG-B18-T32C-AZ-F-P1
		Normally open, mechanical spring return	8033560	VUVG-B18-T32U-AZ-F-P1
		1x normally open, 1x normally closed, mechanical spring return	8033561	VUVG-B18-T32H-AZ-F-P1
		Normally closed, monostable, mechanical spring return	8033562	VUVG-B18-T32C-MZ-F-P1
		Normally open, monostable, mechanical spring return	8033563	VUVG-B18-T32U-MZ-F-P1
		1x normally open, monostable, 1x normally closed, mechanical spring return	8033564	VUVG-B18-T32H-MZ-F-P1
	<b>5/2-way valve, single solenoid</b>			
	External pilot air supply	Mechanical spring return	8033565	VUVG-B18-M52-RZ-F-P1
			8033566	VUVG-B18-M52-MZ-F-P1
	<b>5/2-way valve, double solenoid</b>			
	External pilot air supply		8033567	VUVG-B18-B52-Z-F-P1
	<b>5/3-way valve</b>			
External pilot air supply	Normally closed, mechanical spring return	8033568	VUVG-B18-P53C-Z-F-P1	
	Mid-position exhausted, mechanical spring return	8033569	VUVG-B18-P53E-Z-F-P1	
	Mid-position pressurised, mechanical spring return	8033570	VUVG-B18-P53U-Z-F-P1	

## Manifold assembly

Sub-base valve for manifold assembly  
Connection G1/4



### Dimensions

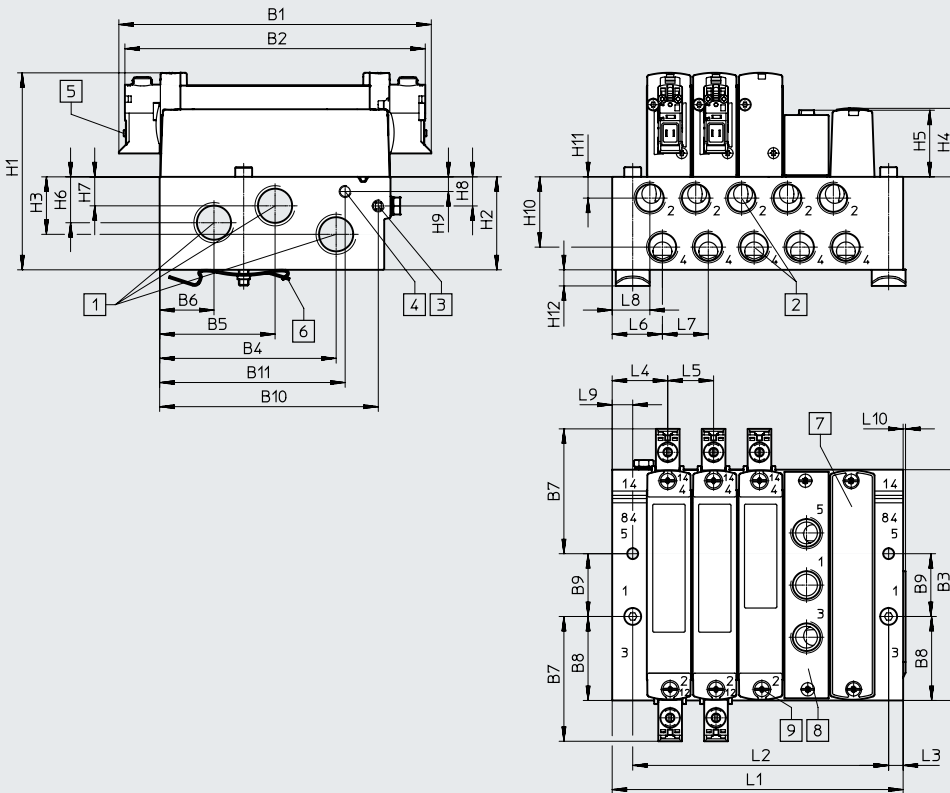

Download CAD data → [www.festo.com](http://www.festo.com)

 **Note**  
More dimensions  
E-boxes  
→ Page 112

- [1] Ports 1, 3 and 5: G3/8 (at both ends)
- [2] Ports 2, 4: G1/4
- [3] Ports 12, 14: M5
- [4] Ports 82, 84: M5
- [5] Electrical connection for E-boxes and accessories
- [6] H-rail mounting (two M4x40 screws are required for mounting)
- [7] Cover plate
- [8] Supply plate, ports 1, 3 and 5: G1/4
- [9] Valve/cover plate/supply plate mounting on manifold rail: M3 thread

Type	B1	B2	B3	B4	B5	B6	B7	B8	B9	B10	B11	D1
VABM-L1-18W-G38	129.4	124.4	95.6	73.1	47.8	22.5	51.7	34.8	26	90.6	76.8	4.5

Type	H1	H2	H3	H4	H5	H6	H7	H8	H9	H10	H11	H12
VABM-L1-18W-G38	81.6	38.5	11.5	28.4	27.6	19	12	12.1	6.1	29.1	8.8	6.5

Type	L3	L4	L5	L6	L7	L8	L9	L10
VABM-L1-18W-G38	6	23	19	20.8	19	15.6	8.5	1

Valve positions	2	3	4	5	6	7	8	9	10	12	14	16
L1	63.5	82.5	101.5	120.5	139.5	158.5	177.5	196.5	215.5	253.5	291.5	329.5
L2	49	68	87	106	125	144	163	182	201	239	277	315
Weight of VABM [g]	232	306	380	454	528	602	676	750	824	972	1120	1268

## Ordering data

### Technical data – Manifold rails<sup>1)</sup>

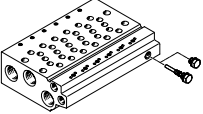
	Connection			KBK	Material <sup>3)</sup>	Operating pressure		Max. tightening torque for assembly [Nm]		
	2, 4	1, 3, 5	12/14, 82/84			[MPa]	[bar]	Valve	H-rail	Wall
	G1/4	G3/8	M5	2 <sup>2)</sup>	Wrought aluminium alloy	-0.09 ... 1	-0.9 ... 10	1.18	1.5	3

1) Blanking plugs are included with the manifold rail.



2) More information: [www.festo.com/x/topic/kbk](http://www.festo.com/x/topic/kbk)

3) Information on materials: RoHS-compliant.

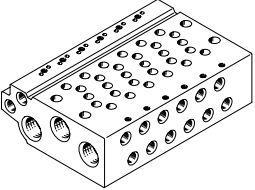
### Ordering data – Manifold rails

	Description	Part no.	Type	
<b>Manifold rail for sub-base valve G1/4</b>				
	For size B18 (G1/4)	2 valve positions	<b>574467</b>	<b>VABM-L1-18W-G38-2</b>
		3 valve positions	<b>574468</b>	<b>VABM-L1-18W-G38-3</b>
		4 valve positions	<b>574469</b>	<b>VABM-L1-18W-G38-4</b>
		5 valve positions	<b>574470</b>	<b>VABM-L1-18W-G38-5</b>
		6 valve positions	<b>574471</b>	<b>VABM-L1-18W-G38-6</b>
		7 valve positions	<b>574472</b>	<b>VABM-L1-18W-G38-7</b>
		8 valve positions	<b>574473</b>	<b>VABM-L1-18W-G38-8</b>
		9 valve positions	<b>574474</b>	<b>VABM-L1-18W-G38-9</b>
		10 valve positions	<b>574475</b>	<b>VABM-L1-18W-G38-10</b>
		12 valve positions	<b>574476</b>	<b>VABM-L1-18W-G38-12</b>
		14 valve positions	<b>574477</b>	<b>VABM-L1-18W-G38-14</b>
16 valve positions	<b>574478</b>	<b>VABM-L1-18W-G38-16</b>		

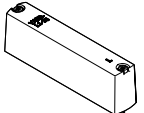
## Ordering data

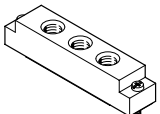
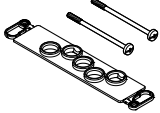
Ordering data – Accessories				
	Description	Part no.	Type	
Cover plate <span style="float: right;">Datasheets → Internet: vabb</span>				
	For valve position on manifold rail, including screws and seal	★ 574482	VABB-L1-18	
Separator <span style="float: right;">Datasheets → Internet: vabd</span>				
	For creating pressure zones	574483	VABD-14-B	
Supply plate <span style="float: right;">Datasheets → Internet: vabf</span>				
	For valve position on manifold rail, including screws and seal	574481	VABF-L1-18-P3A4-G14	
Seals <span style="float: right;">Datasheets → Internet: vabd</span>				
	For sub-base valves G1/4	Delivery quantity: 10 sets (each with 2 screws and 1 seal)	574480	VABD-L1-18B-S-G14

 - **Note**

Connect supply plate at port 1 with compressed air. Reverse operation (pressure at port 3, 5) is not permissible.

E-boxes

General technical data							
Variants	H2	H3	S2	S3	L-	R1	R8
Mounting position	Any						
Electrical connection	2-pin, socket				Flying leads	M8 individual plug, 4-pin	M8 individual plug, 3-pin
Degree of protection	IP40				IP65		
Signal status indication	LED						
Type of mounting	Clip				Self-tapping screw		
Note on materials	RoHS-compliant						
Housing colour	Black						
Information about housing materials	PA						
Certification	RCM						

Protective circuit without holding current reduction

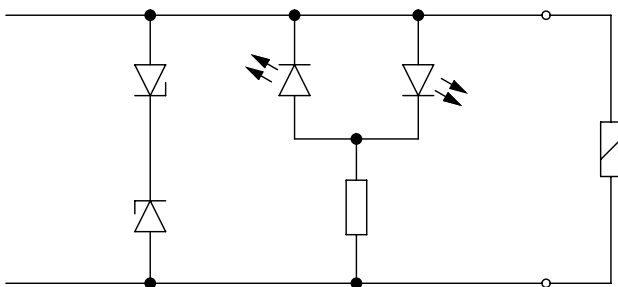

The solenoid coils (P type) of the 5, 12 and 24 V designs have a protective circuit to arrest sparks and protect against polarity reversal.

Protective circuit with holding current reduction

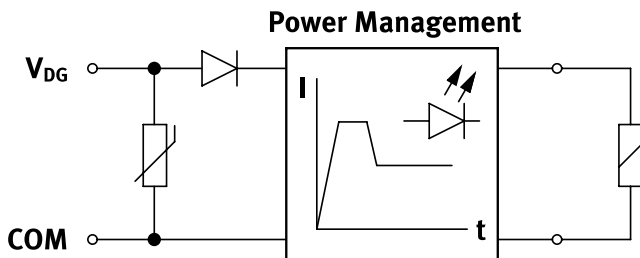



The 24 V DC design (R type) additionally features holding current reduction. This reduces the power from 1 W to 0.35 W.

Pin allocation for E-box

	Pin	Description	
<b>Rectangular plug, connection pattern H</b>			
	VAVE-L1-1VH2-LP, VAVE-L1-1VH3-LP		
	1	+ or -	Without holding current reduction
	2	+ or -	
	VAVE-L1-1H2-LR, VAVE-L1-1H3-LR		With holding current reduction
1	+		
	VAVE-L1-1VS2-LP, VAVE-L1-1VS3-LP		
	1	+ or -	Without holding current reduction
	2	+ or -	
	VAVE-L1-1S2-LR, VAVE-L1-1S3-LR		With holding current reduction
1	-		
	VAVE-L1-1VL1...4-LP		
	1	+ or -	Without holding current reduction
	2	+ or -	
	VAVE-L1-1L1...4-LR		With holding current reduction
1	-		
2	+		

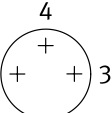
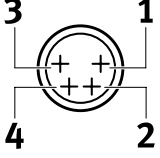
## E-boxes

Pin allocation for E-box		Pin	Description
<b>Round plug, M8, 3-pin</b>			
	<b>VAVE-L1-1VR8-LP</b>		
	1	Not used	Without holding current reduction
	3	+ or -	
	4	+ or -	
	<b>VAVE-L1-1R8-LR</b>		
	1	Not used	With holding current reduction
3	+ or -		
4	+ or -		
<b>Round plug, M8, 4-pin</b>			
	<b>VAVE-L1-1VR1-LP</b>		
	1	Not used	Without holding current reduction
	2	Not used	
	3	+ or -	
	4	+ or -	
	<b>VAVE-L1-1R1-LR</b>		
	1	Not used	With holding current reduction
	2	Not used	
3	+ or -		
4	+ or -		
<b>Open cable end</b>			
	<b>VAVE-L1-1VK...</b>		
	BK	+ or -	Without holding current reduction
	BK	+ or -	
	<b>VAVE-L1-1K...</b>		
BK	+ or -	With holding current reduction	
BK	+ or -		

E-boxes

Dimensions

Download CAD data → [www.festo.com](http://www.festo.com)

E-boxes, S2/H2

E-boxes, S3/H3

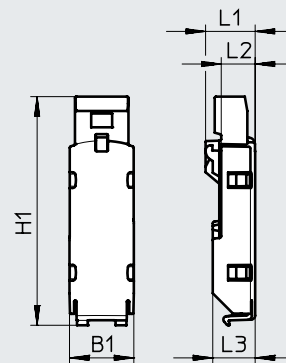
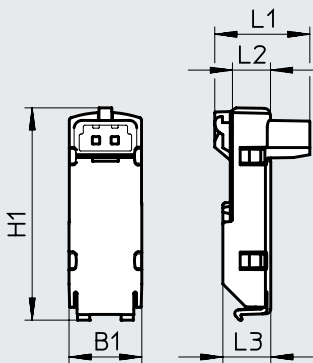

Type	B1	H1 ±0.5	L1	L2	L3
VAVE-L1-1VS2-LP	9.8	28.8	12.9	5.2	6.5
VAVE-L1-1S2-LR					
VAVE-L1-1VH2-LP			10.8		
VAVE-L1-H2-LR					

Type	B1	H1 ±0.5	L1	L2	L3
VAVE-L1-1VS3-LP	9.8	35	7.6	5.2	6.5
VAVE-L1-1S3-LR					
VAVE-L1-1VH3-LP		33.6	7.5		
VAVE-L1-1H3-LR					

Dimensions

Download CAD data → [www.festo.com](http://www.festo.com)

E-boxes, VL11 ...1 4

E-boxes, VK6 ... 9

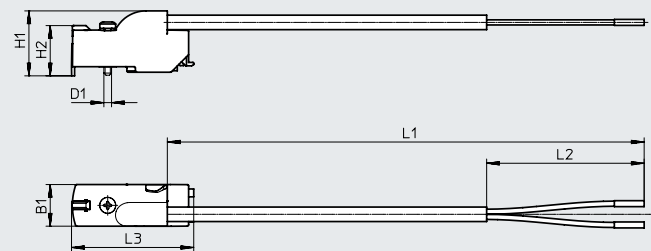
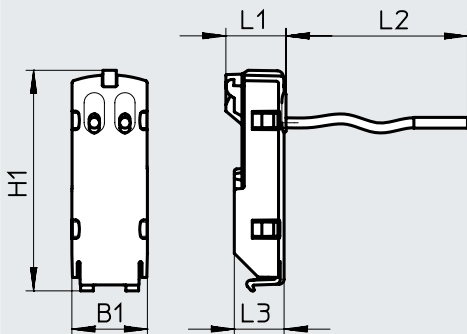

Type	B1	H1 ±0.5	L1	L2	L3
VAVE-L1-1VL1-LP	9.8	28.8	7.9	0.5	6.5
VAVE-L1-1L1-LR					
VAVE-L1-1VL2-LP				1	
VAVE-L1-1L2-LR					
VAVE-L1-1VL3-LP				2.5	
VAVE-L1-1L3-LR					
VAVE-L1-1VL4-LP				5	
VAVE-L1-1L4-LR					

Type	B1	H1	H2 ±0.3	L1	L2 ±5	L3 ±0.5	D1 Ø
VAVE-L1-1VK6-LP	9.8	15.3	11.8	0.5	50	28.7	1.8
VAVE-L1-1VK7-LP				1.0			
VAVE-L1-1VK8-LP				2.5			
VAVE-L1-1VK9-LP				5.0			
VAVE-L1-1K6-LR				0.5			
VAVE-L1-1K7-LR				1.0			
VAVE-L1-1K8-LR				2.5			
VAVE-L1-1K9-LR				5.0			



### E-boxes

#### Dimensions

Download CAD data → [www.festo.com](http://www.festo.com)

E-boxes, R8/R1

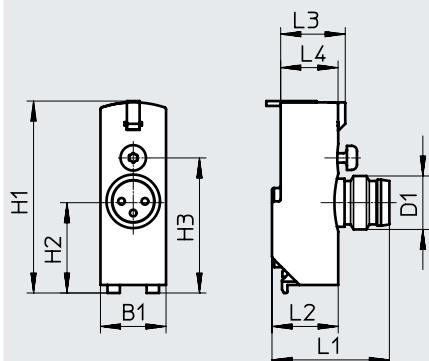



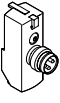

Type	B1	H1	H2	H3	L1	L2	L3	L4	D1 ∅
VAVE-L1-1VR8-LP	9.8	28.7	13.7	20.2	18.4	9.9	9.7	8.6	M8
VAVE-L1-1VR1-LP									

Ordering data – E-boxes								
Design	Plug	Additional functions	Ambient temperature [°C]	Code	Power [W]	Voltage [V DC]	Part no.	Type
	NEBV-H1 ...	Spark arresting, bipolar, IP40	-5 ... +50	H2	1	12/24	★ 566714	VAVE-L1-1VH2-LP
		Spark arresting, holding current reduction, IP40	-5 ... +60	H2R	0.35	24	★ 566716	VAVE-L1-1H2-LR
	NEBV-H1 ...	Spark arresting, bipolar, IP40	-5 ... +50	H3	1	12/24	566715	VAVE-L1-1VH3-LP
		Spark arresting, holding current reduction, IP40	-5 ... +60	H3R	0.35	24	566717	VAVE-L1-1H3-LR
	NEBV-HS ...	Spark arresting, bipolar, IP40	-5 ... +50	S2	1	12/24	566718	VAVE-L1-1VS2-LP
		Spark arresting, holding current reduction, IP40	-5 ... +60	S2R	0.35	24	566720	VAVE-L1-1S2-LR
	NEBV-HS ...	Spark arresting, bipolar, IP40	-5 ... +50	S3	1	12/24	566719	VAVE-L1-1VS3-LP
		Spark arresting, holding current reduction, IP40	-5 ... +60	S3R	0.35	24	566721	VAVE-L1-1S3-LR
	Open cable end	Spark arresting, bipolar, IP40	-5 ... +50	L1	1	12/24	566722	VAVE-L1-1VL1-LP
				L2			566723	VAVE-L1-1VL2-LP
				L3			566724	VAVE-L1-1VL3-LP
				L4			566725	VAVE-L1-1VL4-LP
		Spark arresting, holding current reduction, IP40	-5 ... +60	L1R	0.35	24	566726	VAVE-L1-1L1-LR
				L2R			566727	VAVE-L1-1L2-LR
				L3R			566728	VAVE-L1-1L3-LR
				L4R			566729	VAVE-L1-1L4-LR

E-boxes



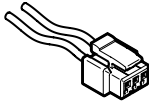
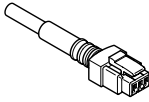
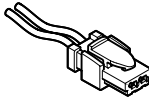
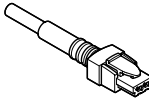
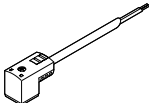
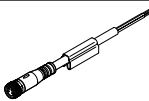
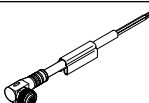
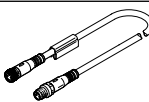
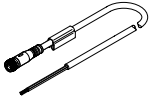
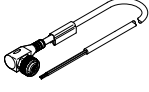

Ordering data – E-boxes									
Design	Plug	Additional functions	Ambient temperature [°C]	Code	Power	Voltage	Cable length	Part no.	Type
					[W]	[V DC]	[m]		
	Open cable end	Spark arresting, bipolar, IP65	-5 ... +60	K6	1	12/24	0.5	★ 573941	VAVE-L1-1VK6-LP
				K7			1	★ 573942	VAVE-L1-1VK7-LP
				K8			2.5	573943	VAVE-L1-1VK8-LP
				K9			5	573944	VAVE-L1-1VK9-LP
		Spark arresting, bipolar, holding current reduction, IP65	-5 ... +60	K6R	0.35	24	0.5	573945	VAVE-L1-1K6-LR
							1	573946	VAVE-L1-1K7-LR
							2.5	573947	VAVE-L1-1K8-LR
							5	573948	VAVE-L1-1K9-LR
	NEBU-M8 ...	Spark arresting, bipolar, IP65	-5 ... +60	R8	1	12/24	-	★ 573919	VAVE-L1-1VR8-LP
		Spark arresting, bipolar, holding current reduction, IP65		R8R	0.35	24	-	573920	VAVE-L1-1R8-LR
		Spark arresting, bipolar, IP65		R1	1	12/24	-	573921	VAVE-L1-1VR1-LP
		Spark arresting, bipolar, holding current reduction, IP65		R1R	0.35	24	-	573922	VAVE-L1-1R1-LR

Ordering data – Pilot controls							
Design	Electrical connection	Manual override	Ambient temperature [°C]	Voltage		Part no.	Type
				[V DC]	[V AC]		
	Type C to DIN EN 175301-803	Non-detenting	-5 ... +50	24	-	8040564	VSCS-B-M32-MH-WA-1C1-8
				12	-	8040565	VSCS-B-M32-MH-WA-5C1-8
				-	24	8040566	VSCS-B-M32-MH-WA-1AC1-8
				-	110	8040567	VSCS-B-M32-MH-WA-2AC1-8
				-	230	8040568	VSCS-B-M32-MH-WA-3AC1-8
	Connection type C to industry standard			24	-	8137327	VSCS-B-M32-MH-WA-1E1-8
				24	-	8040569	VSCS-B-M32-MH-WA-1R3-8
	Type C to DIN EN 175301-803	Non-detenting/detenting		24	-	8040570	VSCS-B-M32-MD-WA-1C1-8
				12	-	8040571	VSCS-B-M32-MD-WA-5C1-8
				-	24	8040572	VSCS-B-M32-MD-WA-1AC1-8
				-	110	8040573	VSCS-B-M32-MD-WA-2AC1-8
				-	230	8040574	VSCS-B-M32-MD-WA-3AC1-8
	Connection type C to industry standard			24	-	8137328	VSCS-B-M32-MD-WA-1E1-8
				24	-	8040575	VSCS-B-M32-MD-WA-1R3-8
	M12 to IEC 61076-2-101			24	-	8040575	VSCS-B-M32-MD-WA-1R3-8

## Accessories







Ordering data	Description	Cable length [m]	Part no.	Type
<b>Plug socket with cable, not sheathed, open end</b>				Datasheets → Internet: nebv
	For E-box code H2, H2R or H3, H3R, 2-pin socket	0.5	★ 566654	NEBV-H1G2-KN-0.5-N-LE2
		1	★ 566655	NEBV-H1G2-KN-1-N-LE2
		2.5	★ 566656	NEBV-H1G2-KN-2.5-N-LE2
		5	566657	NEBV-H1G2-KN-5-N-LE2
<b>Plug socket with cable, sheathed, open end</b>				Datasheets → Internet: nebv
	For E-box code H2, H2R or H3, H3R, 2-pin socket	0.5	★ 566658	NEBV-H1G2-P-0.5-N-LE2
		1	★ 566659	NEBV-H1G2-P-1-N-LE2
		2.5	★ 566660	NEBV-H1G2-P-2.5-N-LE2
		5	566661	NEBV-H1G2-P-5-N-LE2
<b>Plug socket with cable, not sheathed, open end</b>				Datasheets → Internet: nebv
	For E-box code S2, S2R or S3, S3R, 2-pin socket,	0.5	566662	NEBV-HSG2-KN-0.5-N-LE2
		1	566663	NEBV-HSG2-KN-1-N-LE2
		2.5	566664	NEBV-HSG2-KN-2.5-N-LE2
		5	566665	NEBV-HSG2-KN-5-N-LE2
<b>Plug socket with cable, sheathed, open end</b>				Datasheets → Internet: nebv
	For E-box code S2, S2R or S3, S3R, 2-pin socket	0.5	566666	NEBV-HSG2-P-0.5-N-LE2
		1	566667	NEBV-HSG2-P-1-N-LE2
		2.5	566668	NEBV-HSG2-P-2.5-N-LE2
		5	566669	NEBV-HSG2-P-5-N-LE2
<b>Connecting cable, open end</b>				
	For pilot valve VSCS to ISO 15218, narrow socket, type C to EN 175301-803	2.5	8032623	NEBV-C1SW2L-P-K-2.5-N-LE2-S9
		5	8032626	NEBV-C1SW2L-P-K-5-N-LE2-S9
		10	8032627	NEBV-C1SW2L-P-K-10-N-LE2-S9
		2.5	8032628	NEBV-C1SW3-K-2.5-N-LE3-S9
		5	8032629	NEBV-C1SW3-K-5-N-LE3-S9
<b>Connecting cable, open end</b>				Datasheets → Internet: nebu
	For E-box code R8 3-pin, straight socket, M8x1	2.5	★ 541333	NEBU-M8G3-K-2.5-LE3
		5	★ 541334	NEBU-M8G3-K-5-LE3
	For E-box code R1 4-pin, straight socket, M8x1	2.5	541342	NEBU-M8G4-K-2.5-LE4
		5	541343	NEBU-M8G4-K-5-LE4
<b>Connecting cable, open end</b>				Datasheets → Internet: nebu
	For E-box code R8 3-pin, angled socket, M8x1	2.5	★ 541338	NEBU-M8W3-K-2.5-LE3
		5	★ 541341	NEBU-M8W3-K-5-LE3
	For E-box code R1 4-pin, angled socket, M8x1	2.5	541344	NEBU-M8W4-K-2.5-LE4
		5	541345	NEBU-M8W4-K-5-LE4
<b>Connecting cable</b>				Datasheets → Internet: nebu
	For E-box code R8 3-pin, straight socket, M8x1	0.5	★ 541346	NEBU-M8G3-K-0.5-M8G3
		1	★ 541347	NEBU-M8G3-K-1-M8G3
		2.5	★ 541348	NEBU-M8G3-K-2.5-M8G3
		5	★ 541349	NEBU-M8G3-K-5-M8G3
	10	569844	NEBU-M8G3-K-10-M8G3	
For E-box code R1 4-pin, straight socket, M8x1	2.5	554035	NEBU-M8G4-K-2.5-M8G4	
<b>Connecting cable, open end</b>				Datasheets → Internet: nebu
	For pilot valve VSCS to ISO 15218, straight socket, M12x1, A-coded to EN 61076-2-101	2.5	541363	NEBU-M12G5-K-2.5-LE3
		5	541364	NEBU-M12G5-K-5-LE3
	For pilot valve VSCS to ISO 15218, angled socket, M12x1, A-coded to EN 61076-2-101	2.5	541367	NEBU-M12W5-K-2.5-LE3
		5	541370	NEBU-M12W5-K-5-LE3

Accessories

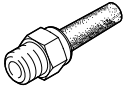
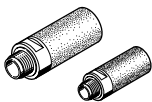
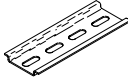
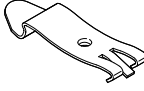
Ordering data		Description	Part no.	Type	PE <sup>1)</sup>		
<b>Blanking plug</b>		Datasheets → Internet: b					
	For manifold rail and valve	M5 thread	★ 3843	B-M5	10		
		M7 thread	★ 174309	B-M7	10		
	For manifold rail	G1/8 thread	★ 3568	B-1/8	10		
		G1/4 thread	★ 3569	B-1/4	10		
		G3/8 thread	★ 3570	B-3/8	10		
	For valve	G1/8 thread	578406	NPQH-BK-G18-P10	10		
		G1/4 thread	578407	NPQH-BK-G14-P10	10		
<b>Reducing nipple</b>							
	Male thread M7	Female thread M5	161359	D-M5I-M7A-ISK	10		
<b>Fittings</b>		Datasheets → Internet: qsm					
	M3 thread	For tubing Ø 3 mm	Round releasing ring	133001	QSM-M3-3-I-R	10	
		For tubing Ø 4 mm	Round releasing ring	133002	QSM-M3-4-I-R	10	
	M5 thread	For tubing Ø 3 mm	Round releasing ring	133003	QSM-M5-3-I-R	10	
			Oval releasing ring	153313	QSM-M5-3-I	10	
		For tubing Ø 4 mm	Round releasing ring	133004	QSM-M5-4-I-R	10	
			Oval releasing ring	★ 153315	QSM-M5-4-I	10	
		For tubing Ø 6 mm	Round releasing ring	133005	QSM-M5-6-I-R	10	
			Oval releasing ring	★ 153317	QSM-M5-6-I	10	
	M7 thread	For tubing Ø 4 mm	Oval releasing ring	★ 153319	QSM-M7-4-I	10	
		For tubing Ø 6 mm	Round releasing ring	133007	QSM-M7-6-I-R	10	
			Oval releasing ring	★ 153321	QSM-M7-6-I	10	
	G1/8 thread	For tubing Ø 4 mm	Oval releasing ring	★ 186106	QS-G1/8-4-I	10	
		For tubing Ø 6 mm	Oval releasing ring	★ 186107	QS-G1/8-6-I	10	
		For tubing Ø 8 mm	Oval releasing ring	★ 186109	QS-G1/8-8-I	10	
		For tubing Ø 10 mm	Oval releasing ring	★ 132999	QS-G1/8-10-I	10	
	G1/4 thread	For tubing Ø 6 mm	Oval releasing ring	★ 186108	QS-G1/4-6-I	10	
				130677	QS-1/4-6-100	100	
		For tubing Ø 8 mm	Oval releasing ring	★ 186110	QS-G1/4-8-I	10	
				★ 153016	QS-1/4-8-I	10	
		For tubing Ø 10 mm	Oval releasing ring	★ 186112	QS-G1/4-10-I	10	
				★ 153018	QS-1/4-10-I	10	
		3/8 thread	For tubing Ø 8 mm	Oval releasing ring	130681	QS-3/8-8-50	50
			For tubing Ø 10 mm	Oval releasing ring	130682	QS-3/8-10-50	50
	For tubing Ø 12 mm		Oval releasing ring	130683	QS-3/8-12-20	20	
For tubing Ø 16 mm	Oval releasing ring		164957	QS-3/8-16	1		





1) Packaging unit.

## Accessories

Ordering data		Description	Part no.	Type	PE <sup>1)</sup>	
<b>Silencers</b> <span style="float: right;">Datasheets → Internet: amte</span>						
	For M3 thread		1231120	AMTE-M-LH-M3	20	
	For M5 thread		★ 1205858	AMTE-M-LH-M5	20	
	For M7 thread		161418	UC-M7	1	
	For G1/8 thread	High flow rate	★ 2307	U-1/8	1	
		Lower flow rate	161419	UC-1/8	1	
	For G1/4 thread	High flow rate	★ 2316	U-1/4	1	
		Lower flow rate	165004	UC-1/4	1	
	For G3/8 thread	High flow rate	★ 2309	U-3/8	1	
		Lower flow rate	1707427	UC-3/8	1	
		Metal housing	★ 6843	U-3/8-B	1	
<b>H-rail</b> <span style="float: right;">Datasheets → Internet: nrh</span>						
	To EN 60715, 35 x 7.5 (WxH)	Length: 2 m	35430	NRH-35-2000	1	
<b>H-rail mounting</b> <span style="float: right;">Datasheets → Internet: vame</span>						
	-		★ 569998	VAME-T-M4	2	
<b>Cover cap for manual override</b>						
	Concealed		540898	VMPA-HBV-B	10	
	Non-detenting		540897	VMPA-HBT-B	10	
	Detenting (without accessories)		8002234	VAMC-L1-CD	10	
<b>Identification holder</b> <span style="float: right;">Datasheets → Internet: aslr</span>						
	Holder for an inscription label and covering for the retaining screw and manual override		570818	ASLR-D-L1	10	
<b>Mounting kit</b> <span style="float: right;">Datasheets → Internet: davm</span>						
	With mounting bracket for lateral valve mounting	For standards-based cylinder DSBC-32...40	For VUVG-L14	2568514	DAVM-MW-V1-32-V	1
		For standards-based cylinder DSBC-50...125	For VUVG-L18	2612128	DAVM-MW-V1-50-V	1

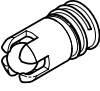
1) Packaging unit.

Accessories

Ordering data		Description	Part no.	Type	PE <sup>1)</sup>	
<b>Check valve</b>						
	For manifold rails VABM-L1-10...	For blocking the flow in the event of back pressure in duct 3 and 5	8047364	VABF-L1-10H-H2	10	
	For manifold rails VABM-L1-14...		8047365	VABF-L1-14-H2	10	
<b>Flow control valve</b>						
	For manifold rails VABM-L1-10...	For setting the flow rate during pressurisation and exhausting (for M5 threaded connection)	Nominal width: 0.5 mm	8025709	VFFG-T-M5-5	10
			Nominal width: 0.6 mm	8025710	VFFG-T-M5-6	10
			Nominal width: 0.7 mm	8025711	VFFG-T-M5-7	10
			Nominal width: 0.85 mm	8025712	VFFG-T-M5-8	10
			Nominal width: 1.05 mm	8025713	VFFG-T-M5-10	10
			Nominal width: 1.2 mm	8025714	VFFG-T-M5-12	10
		For setting the flow rate for pressurisation and exhausting (for $\varnothing$ 4 mm)	Nominal width: 0.5 mm	8047346	VFFG-T-F4-5	10
			Nominal width: 0.6 mm	8047347	VFFG-T-F4-6	10
			Nominal width: 0.7 mm	8047348	VFFG-T-F4-7	10
			Nominal width: 0.85 mm	8047349	VFFG-T-F4-8	10
			Nominal width: 1.05 mm	8047350	VFFG-T-F4-10	10
			Nominal width: 1.2 mm	8047351	VFFG-T-F4-12	10
	For manifold rails VABM-L1-14...	For setting the flow rate for pressurisation and exhausting (for $\varnothing$ 5.8 mm)	Nominal width: 1.55 mm	8025715	VFFG-T-M5-15	10
			Nominal width: 0.7 mm	8047353	VFFG-T-F6-7	10
			Nominal width: 0.85 mm	8047354	VFFG-T-F6-8	10
			Nominal width: 1.05 mm	8047355	VFFG-T-F6-10	10
			Nominal width: 1.15 mm	8047356	VFFG-T-F6-11	10
			Nominal width: 1.4 mm	8047357	VFFG-T-F6-14	10
			Nominal width: 1.6 mm	8047358	VFFG-T-F6-16	10
			Nominal width: 1.8 mm	8047359	VFFG-T-F6-18	10
<b>Flow control set</b>						
	For manifold rails VABM-L1-10...	Two of each size, for M5 threaded connection	8025716	VFFG-T-M5-A-V1	14	
		Two of each size, for $\varnothing$ 4 mm	8062200	VFFG-T-F4-A-V1	14	
	For manifold rails VABM-L1-14...	Two of each size, for $\varnothing$ 5.8 mm	8062201	VFFG-T-F6-A-V1	14	

1) Packaging unit.