

Solenoid/pneumatic valves, Tiger Classic

FESTO

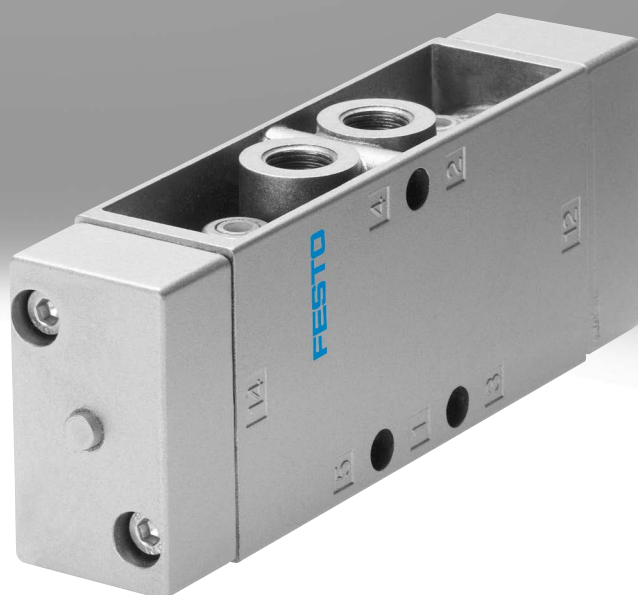

Key features

General

- Very sturdy poppet valve concept for all 3/2- and 5/2-way valves
- Pneumatically or electrically actuated with F solenoid coil
- With flow rates of up to 7500 l/min
- With internal or external pilot air
- Pipe thread in sizes G1/8, G1/4, G1/2 and G3/4
- Tried-and-tested mounting using hollow bolt on PAL or PRS rail (no ATEX category)
- Optimised switching times thanks to patented U-ring and servo control

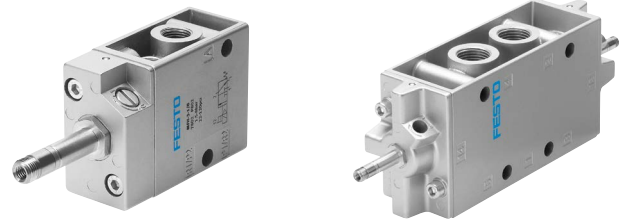

Note
Valves for potentially explosive atmospheres (ATEX category) are not suitable for mounting on manifold rails PAL or manifold blocks PRS.

Solenoid coils

F solenoid coils

- | | | | |
|--|--|--|--|
| <p>Voltage:</p> <ul style="list-style-type: none"> • 12 to 230 V DC • 12 to 240 V AC (50 to 60 Hz) | <p>Power consumption:</p> <ul style="list-style-type: none"> • 4.1 to 5.5 W DC • 3.85 to 9 VA AC | <ul style="list-style-type: none"> • Selected types conform to the ATEX directive for potentially explosive atmospheres | <ul style="list-style-type: none"> • Solenoid coil can be easily exchanged later • Solenoid coil not included in scope of delivery |
|--|--|--|--|

Variants

VL/O-3-...

Depending on selected connections:
Normally closed or normally open

MFH-3-..., MOFH-3-...

- MFH-3-...
Normally closed
- MOFH-3-...
Normally open

These valves can be converted from one function to the other by rotating the seal under the cover.

MFH-3-...-S

Between 0 and 0.8 bar this valve can also be used as MOFH (normally open) with a separate pilot line.

MFH-5-...-S

The external pilot air connection means that these valves can also be used with low operating pressures.

Key features

Manifold assembly

With manifold rail PAL



With manifold block PRS



The Tiger Classic valves can be mounted on manifold rails PAL with common supply port or on manifold blocks PRS with common supply port and common exhausts. The valves are mounted on the rails and blocks using hollow bolts. The manifold rail and manifold block have 2 to 6 valve positions. Vacant positions can be sealed on manifold rails PAL with cap nuts, or with cover plates on manifold blocks PRS.

A separate pressure level can be supplied to individual valves via hollow bolts with threaded connection.

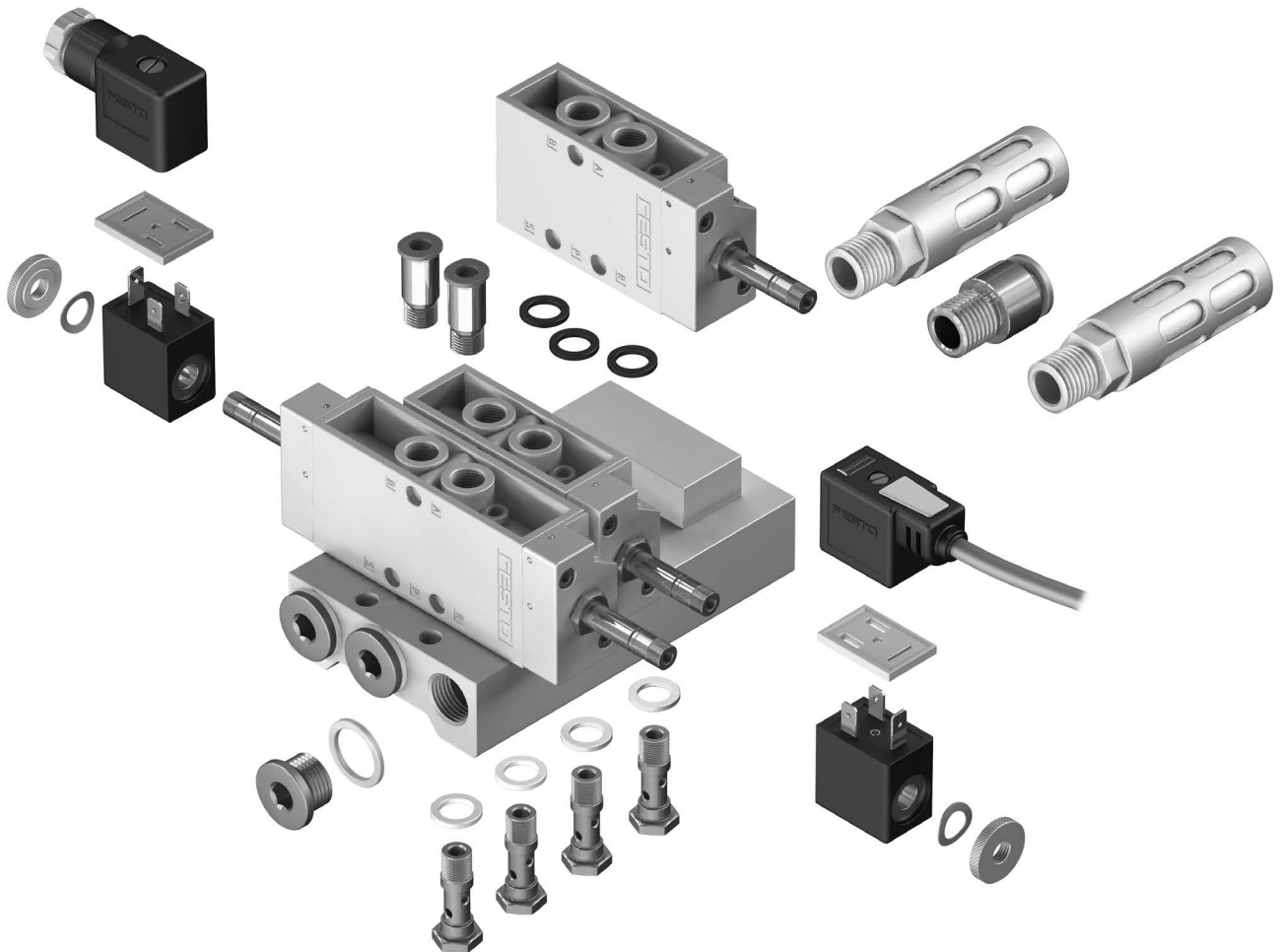

Product range overview

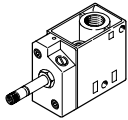
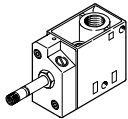
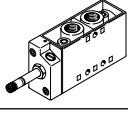
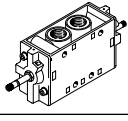
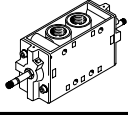
Function	Version	Type	Pneumatic connection	Operating voltage	
				[V DC]	[V AC]
3/2-way valves	Solenoid valve				
		MFH	G1/8	12, 24, 42, 48	24, 42, 48, 110, 230, 240
			G1/4		
			G1/2		
			G3/4		
		MOFH	G1/8	12, 24, 42, 48	24, 42, 48, 110, 230, 240
			G1/4		
			G1/2		
G3/4					
5/2-way valves	Solenoid valve				
		MFH	G1/8	12, 24, 42, 48	24, 42, 48, 110, 230, 240
			G1/4		
			G1/2		
	Double solenoid valve				
		JMFH	G1/8	12, 24, 42, 48	24, 42, 48, 110, 230, 240
			G1/4		
			G1/2		
	Double solenoid valve with dominant signal				
		JMFHDH	G1/8	12, 24, 42, 48	24, 42, 48, 110, 230, 240
G1/4					

Product range overview

Type	Initial position		Pilot air supply		Reset method		→ Page
	Closed	Open	Internal	External	Pneumatic spring	Mechanical spring	
Solenoid valve							
MFH	■	–	■	■	–	■	12
	■	–	■	■	–	■	
	■	–	■	■	–	■	
	■	–	■	■	–	■	
MOFH	–	■	■	–	–	■	12
	–	■	■	–	–	■	
	–	■	■	–	–	■	
	–	■	■	–	–	■	

Type	Pilot air supply		Reset method		→ Page
	Internal	External	Pneumatic spring	Mechanical spring	
Solenoid valve					
MFH	■	■	–	■	18
	■	■	–	■	
	■	■	–	■	
Double solenoid valve					
JMFH	■	■	–	–	24
	■	■	–	–	
	■	■	–	–	
Double solenoid valve with dominant signal					
JMFDH	–	■	–	–	24
	–	■	–	–	

Product range overview

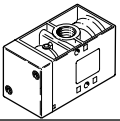
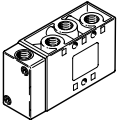
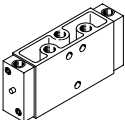
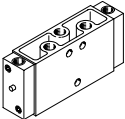
Function	Version	Type	Pneumatic connection	Reset method		→ Page/Internet
				Pneumatic spring	Mechanical spring	
3/2-way valves	Pneumatic valve					
		VL/O	G1/8	–	■	31
			G1/4	–	■	
			G1/2	–	■	
G3/4			–	■		
5/2-way valves	Pneumatic valve					
		VL	G1/8	–	■	37
			G1/4	–	■	
			G1/2	–	■	
	Pneumatic double pilot valve					
		JH	G1/8	–	–	41
			G1/4	–	–	
			G1/2	–	–	
	Pneumatic bistable valve with dominant signal					
		JDH	G1/8	–	–	41
G1/4			–	–		

Type codes

001	Series
MCH	Solenoid valve, with armature tube for C solenoid coil, single solenoid, normally closed
MFH	Solenoid valve, with armature tube for F solenoid coil, single solenoid, normally closed
MOCH	Solenoid valve, with armature tube for C solenoid coil, single solenoid, normally open
MOFH	Solenoid valve, with armature tube for F solenoid coil, single solenoid, normally open
JMFH	Solenoid valve, with armature tube for F solenoid coil, double solenoid
JMFDH	Solenoid valve, with armature tube for F solenoid coil, with dominant signal, double solenoid
JH	Pneumatic double pilot valve
JDH	Pneumatic double pilot valve with dominant signal
VL/O	Pneumatic valve, monostable, normally open or closed
VL	Pneumatic valve, monostable

002	Valve function
3	3/2-way valve
5	5/2-way valve

003	Pneumatic connection
G18	G1/8
G14	G1/4
G12	G1/2
G34	G3/4

004	EU certification
	None
EX4	II 2GD

005	Pilot air
S	External
	Internal

Peripherals overview: Solenoid valves

Mounting on manifold block

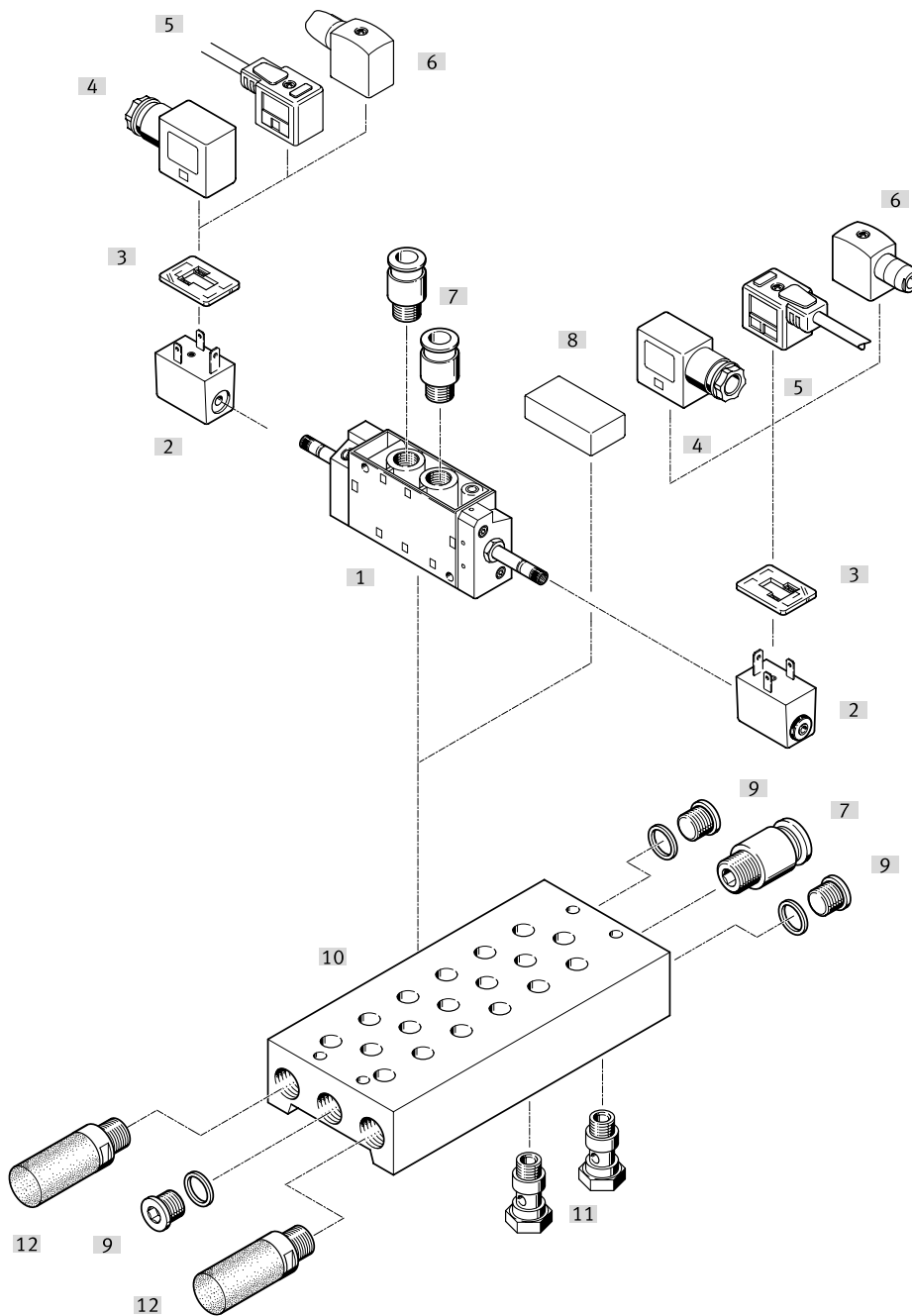

Variants

MFH-5-...

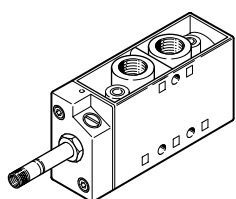

JMFH-5-...

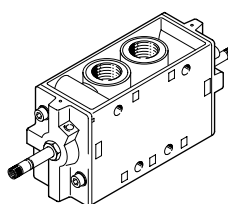

Peripherals overview: Solenoid valves

Accessories		Brief description	→ Page/Internet
[1]	Solenoid valve JMFH	For F solenoid coil	–
[2]	F solenoid coil MSFG, MSFW	–	50
[3]	Illuminating seal M...-LD	For indicating the switching status	51
[4]	Plug socket MSSD-F	For valves MFH, JMFH	50
[5]	Connecting cable KMF	For valves MFH, JMFH	50
[6]	Plug socket MSSD-F-S	For valves MFH, JMFH	50
[7]	Push-in fitting QS	For connecting tubing with standard O.D.	q5
[8]	Cover plate PRSB	For covering a vacant position	49
[9]	Blanking plug B	3 included in the scope of delivery of the manifold block PRS	blanking plug
[10]	Manifold block PRS	–	48
[11]	Hollow bolt VT	For distributing compressed air or for separate compressed air supply	47
[12]	Silencer	For mounting in exhaust ports	–

Peripherals overview: Solenoid valves

Mounting on manifold rail

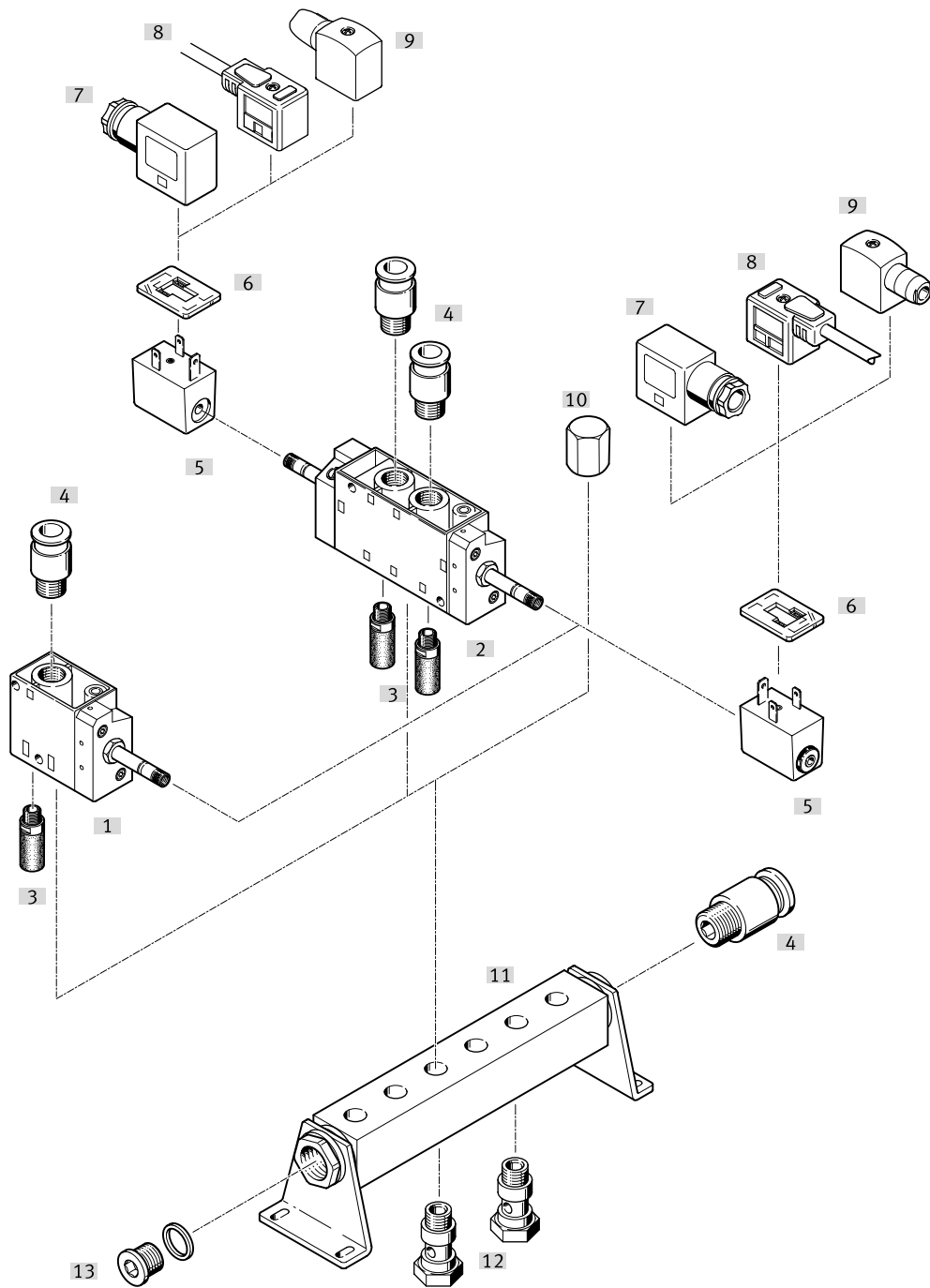

Variants

MFH-5-...

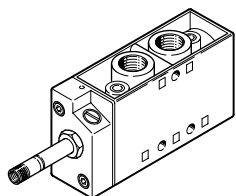

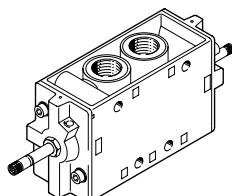

JMFH-5-...



Peripherals overview: Solenoid valves

Accessories		Brief description	→ Page/Internet
[1]	Solenoid valve MFH	For F solenoid coil	4
[2]	Solenoid valve JMFH	For F solenoid coil	4
[3]	Silencer	For mounting in exhaust ports	–
[4]	Push-in fitting QS	For connecting tubing with standard O.D.	qs
[5]	F solenoid coil MSFG, MSFW	–	50
[6]	Illuminating seal M...-LD	For indicating the switching status	51
[7]	Plug socket MSSD-F	For valves MFH, JMFH	50
[8]	Connecting cable KMF	For valves MFH, JMFH	50
[9]	Plug socket MSSD-F-S	For valves MFH, JMFH	50
[10]	Cap nut VTM	For blanking a vacant position	47
[11]	Manifold rail PAL	–	46
[12]	Hollow bolt VT	For distributing compressed air or for separate compressed air supply	47
[13]	Blanking plug B	1 included in the scope of delivery of the manifold rail PAL	blanking plug

Datasheet – 3/2-way valves

-  Flow rate
500 ... 7500 l/min
-  Voltage
12, 24, 42, 48 V DC
24, 42, 48, 110, 230,
240 V AC

Sets of wearing parts → page 17



General technical data		G1/8	G1/4	G1/2	G3/4
Pneumatic connection		G1/8	G1/4	G1/2	G3/4
Valve function		3/2-way, single solenoid			
Design		Poppet seat			
Overlap		Negative overlap			
Sealing principle		Soft			
Actuation type		Electrical			
Reset method		Mechanical spring			
Type of control		Piloted			
Pilot air supply		Internal or external			
Flow direction		Non-reversible (reversible/reversible with restrictions with external pilot air supply)			
Exhaust air function		Can be throttled			
Manual override		Detenting			
Type of mounting		Via through-hole or on manifold rail/manifold block ¹⁾			
Mounting position		Any			
Electrical connection		Via F solenoid coil, to be ordered separately			
Connection for venting hole		M5 (only ATEX types)			
Pilot exhaust air port 82/84		M5			
Pilot air port 12		M5	M5	G1/8	G1/8
b value		–	–	0.3	–
Nominal width [mm]		5	7	14	19
Standard nominal flow rate [l/min]		500	800	3700	7500
Product weight [g]		240	320	1100	1260

1) Types MFH-3-3/4- and MOFH-3-3/4- can only be mounted via through-hole

Safety characteristics		MFH- ... -EX	MOFH- ... -EX	JMFH- ... -EX	JMFDH- ... -EX
Type					
Max. switching frequency [Hz]		3	–	25	16
Max. positive test pulse with 0 signal [µs]		2200			
Max. negative test pulse with 1 signal [µs]		3700 ¹⁾			

1) Not valid for types MFH-3-3/4- and MOFH-3-3/4-

ATEX		MFH- ... -EX, JMFH- ... -EX
Type		
ATEX category for gas		II 2G
Type of ignition protection for gas		Ex h IIC T4 Gb
ATEX category for dust		II 2D
Type of ignition protection for dust		Ex h IIIC T130°C Db
Explosion-proof ambient temperature [°C]		–5 ≤ Ta ≤ +40
CE marking (see declaration of conformity)		To EU Explosion Protection Directive (ATEX)
UKCA marking (see declaration of conformity)		According to UK explosion regulations
Explosion protection certification outside the EU		EPL Db (GB) EPL Gb (GB)
Degree of protection		IP65 (when mounted)

Datasheet – 3/2-way valves

Operating and environmental conditions			G1/8	G1/4	G1/2	G3/4	G1/8-EX	G1/4-EX	G1/2-EX	G3/4-EX
Operating medium			Compressed air to ISO 8573-1:2010 [7:4:4]							
Pilot medium			Compressed air to ISO 8573-1:2010 [7:4:4] (with external pilot air supply)							
Note on the operating/pilot medium			Lubricated operation possible (in which case lubricated operation will always be required)							
Operating pressure	Internal pilot air supply	[MPa]	0.15 ... 0.8		0.2 ... 0.8		0.15 ... 0.8		0.2 ... 0.8	
		[bar]	1.5 ... 8		2 ... 8		1.5 ... 8		2 ... 8	
	External pilot air supply	[MPa]	-0.095 ... 1							
		[bar]	-0.95 ... 10							
Pilot pressure (external pilot air supply)		[MPa]	0.1 ... 0.8							
		[bar]	1 ... 8							
Ambient temperature	[°C]	[°C]	-5 ... +40							
Temperature of medium	[°C]	[°C]	-10 ... +60				-5 ... +40			
Storage temperature		[°C]	-20 ... +60							
Certification			c UL us - Recognized (OL)				-			
Note on materials			RoHS-compliant							
Corrosion resistance class CRC ¹⁾			1							
LABS (PWIS) conformity			VDMA24364-B1/B2-L							

1) More information: www.festo.com/x/topic/crc

Electrical data			
F solenoid coil			
Electrical connection		Plug pins for plug sockets MSSD-F, KMF	
Operating voltage	DC voltage	[V DC]	12, 24, 42, 48
	Alternating voltage	[V AC]	24, 42, 48, 110, 230, 240 (50 ... 60 Hz)
Characteristic coil data	DC voltage	[W]	4.5
	Alternating voltage	[VA]	Pull: 7.5 Hold: 6
Degree of protection to EN 60529		IP65 (in combination with plug socket)	

Valve switching times [ms]								
Pneumatic connection	G1/8		G1/4		G1/2		G3/4	
	Closed	Open	Closed	Open	Closed	Open	Closed	Open
internal pilot air supply								
On	9	9	10	14	18	18	36	40
Off	29	29	29	41	90	90	32	29
external pilot air supply								
On	9	-	10	-	18	-	36	-
Off	29	-	29	-	90	-	32	-

Datasheet – 3/2-way valves

Minimum pilot pressure p_{12}/p_{14} as a function of operating pressure p_1 (external pilot air supply)

MFH-3-1/8-S

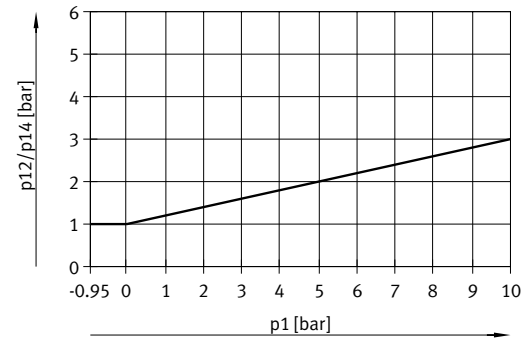

MFH-3-1/4-S

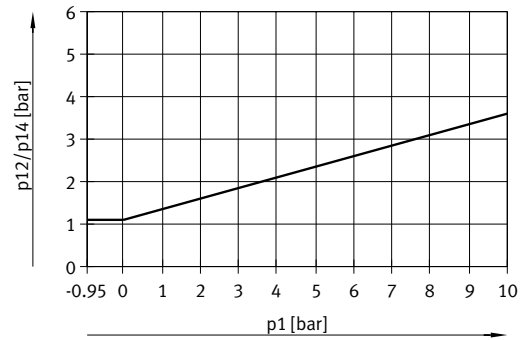

MFH-3-1/2-S

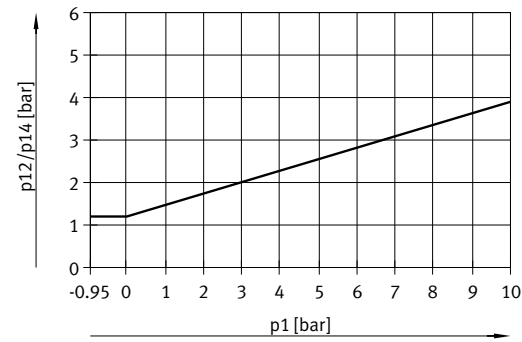

MFH-3-3/4-S

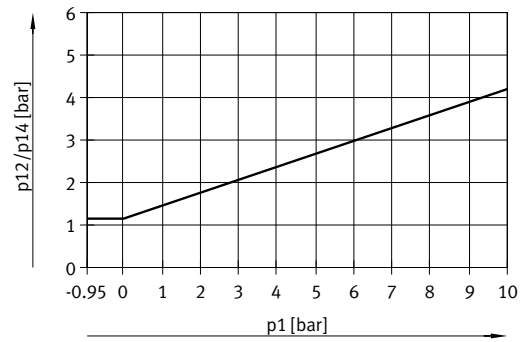

Materials

Sectional view

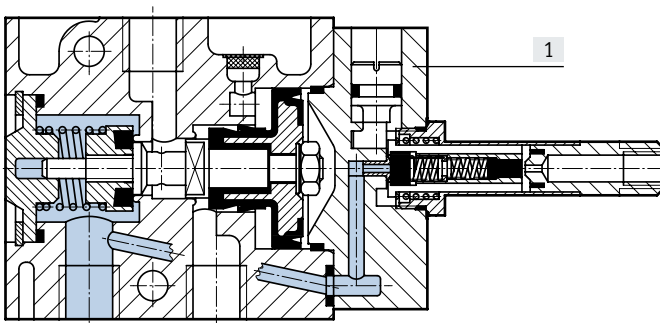

[1]	Housing	Die-cast aluminium
-	Seals	NBR

Datasheet – 3/2-way valves

Dimensions

MFH, MOFH

Download CAD data → www.festo.com

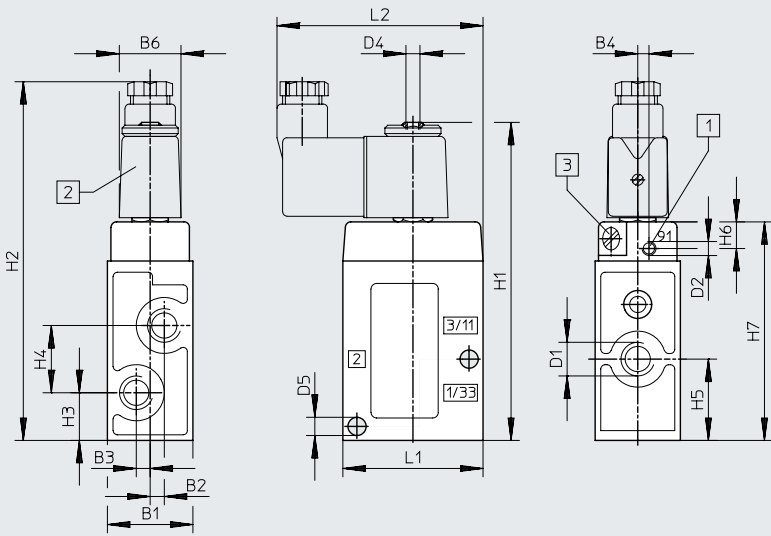

- [1] Additional connection for external pilot air with MFH-3-... /MOFH-3-...
- [2] Solenoid coil can be rotated 360°
- [3] Manual override can be turned 180°



Type	B1	B2	B3	B4	B6	D1	D2	D4	D5 ∅
M...-3-1/8	26 +0.2	3.5	3.5	–	22	G1/8	–	M5	5.5
M...-3-1/8-S				2.7			M5		
M...-3-1/4	30.4 ±0.15	5	5	–	22	G1/4	–	M5	6.5
M...-3-1/4-S	30.4			4					
M...-3-1/2	52 ±0.15	8	8	–		G1/2	–	M5	8.6
M...-3-1/2-S	52								
M...-3-3/4	68 ±0.15	8	8	–	G3/4	–	M5	8.6	
M...-3-3/4-S	68								G1/8

Type	H1	H2	H3	H4	H5	H6	H7	L1	L2
M...-3-1/8	97	111	12.5	19 ±0.15	22	–	63	45 ±0.15	71
M...-3-1/8-S						9.5			
M...-3-1/4	112	126	17	24 ±0.15	29	–	78	50 ±0.15	73.5
M...-3-1/4-S				24		9.5			
M...-3-1/2	151	165	30 ±0.15	38 ±0.15	49 ±0.15	–	117	80 ±0.2	88.5
M...-3-1/2-S			30	38	49	10.5		80	
M...-3-3/4	171	187	34	44 ±0.15	56	–	137	92 ±0.2	94.5
M...-3-3/4-S				44		11		92	

Datasheet – 3/2-way valves

Dimensions

Download CAD data → www.festo.com

Mounting diagram

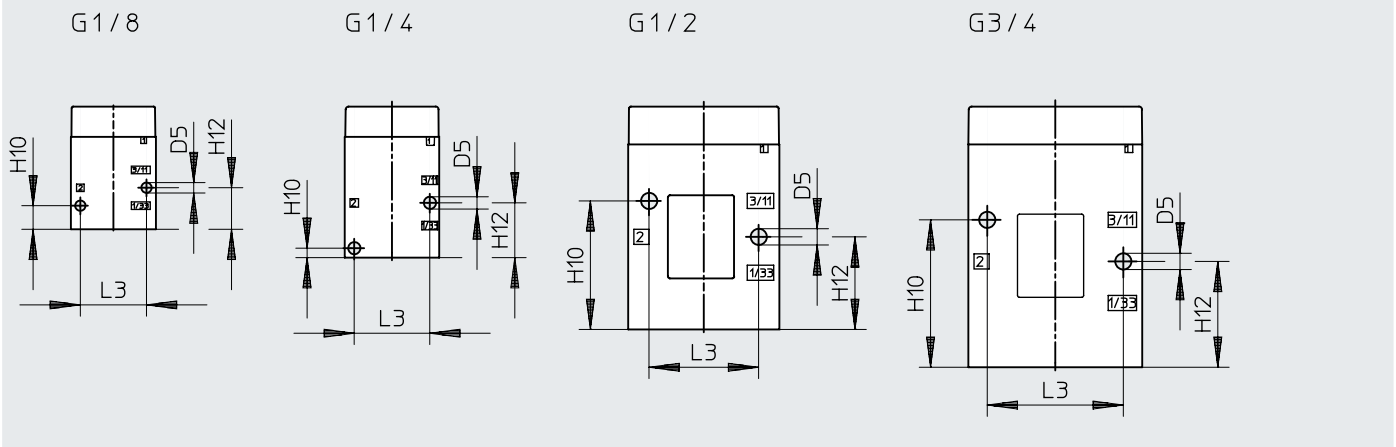

Type	D5 ∅	H10	H12	L3
M...-3-1/8	5.5	12.5	22	35 ±0.15
M...-3-1/8-S				
M...-3-1/4	6.5	5	29	40 ±0.15
M...-3-1/4-S				
M...-3-1/2	8.6	68	49	58 ±0.2
M...-3-1/2-S				
M...-3-3/4	8.6	78	56	72 ±0.2
M...-3-3/4-S				

Datasheet – 3/2-way valves

Ordering data					
Circuit symbol	Description	Pneumatic connection	ATEX category	Part no.	Type
	Without F solenoid coil ¹⁾ , internal pilot air supply	G1/8	–	7802	MFH-3-1/8
			ATEX category → Page 12	535897	MFH-3-1/8-EX
		G1/4	–	9964	MFH-3-1/4
			ATEX category → Page 12	535898	MFH-3-1/4-EX
		G1/2	–	9857	MFH-3-1/2
			ATEX category → Page 12	535899	MFH-3-1/2-EX
		G3/4	–	11967	MFH-3-3/4
			ATEX category → Page 12	536190	MFH-3-3/4-EX
	Without F solenoid coil ¹⁾ , internal pilot air supply	G1/8	–	7877	MOFH-3-1/8
			ATEX category → Page 12	535903	MOFH-3-1/8-EX
		G1/4	–	7876	MOFH-3-1/4
			ATEX category → Page 12	535904	MOFH-3-1/4-EX
		G1/2	–	7884	MOFH-3-1/2
			ATEX category → Page 12	535905	MOFH-3-1/2-EX
		G3/4	–	11969	MOFH-3-3/4
			ATEX category → Page 12	536192	MOFH-3-3/4-EX
	Without F solenoid coil ¹⁾ , external pilot air supply, reversible (no restrictions with vacuum at port 1, restrictions with vacuum at port 3)	G1/8 ²⁾	–	7958	MFH-3-1/8-S
			ATEX category → Page 12	535900	MFH-3-1/8-S-EX
		G1/4 ³⁾	–	7959	MFH-3-1/4-S
			ATEX category → Page 12	535901	MFH-3-1/4-S-EX
		G1/2 ⁴⁾	–	7960	MFH-3-1/2-S
			ATEX category → Page 12	535902	MFH-3-1/2-S-EX
		G3/4 ⁵⁾	–	11968	MFH-3-3/4-S
			ATEX category → Page 12	536191	MFH-3-3/4-S-EX

1) F solenoid coils → page 50

2) Restrictions with vacuum at port 3: (0 ... –0.7 bar)

3) Restrictions with vacuum at port 3: (0 ... –0.6 bar)



4) Restrictions with vacuum at port 3: (0 ... –0.55 bar)

5) Restrictions with vacuum at port 3: (0 ... –0.4 bar)

Ordering data – Sets of wearing parts

Pneumatic connection	Part no.	Type
G1/8	104206	MFH-3-1/8
G1/4	104207	MFH-3-1/4
G1/2	104208	MFH-3-1/2

Datasheet – 5/2-way valves

-  - Flow rate
500 ... 3700 l/min
-  - Voltage
12, 24, 42, 48 V DC
24, 42, 48, 110, 230,
240 V AC

Sets of wearing parts → page 23



General technical data				
Pneumatic connection		G1/8	G1/4	G1/2
Valve function		5/2-way, single solenoid		
Design		Poppet seat		
Overlap		Negative overlap		
Sealing principle		Soft		
Actuation type		Electrical		
Reset method		Mechanical spring		
Type of control		Piloted		
Flow direction		Not reversible		
Pilot air supply		Internal or external		
Exhaust air function		Can be throttled		
Manual override		Detenting		
Type of mounting		Via through-hole or on manifold rail/manifold block		
Mounting position		Any		
Electrical connection		Via F solenoid coil, to be ordered separately		
Connection for venting hole		M5 (only ATEX types)		
Pilot exhaust air port 82/84		M5		
Pilot air port 14		M5	M5	G1/8
b value		–	0.19	0.32
c value	[l/sbar]	–	4.49	–
Nominal width	[mm]	5	7	14
Standard nominal flow rate	[l/min]	500	1000	3700
Product weight	[g]	270	290	1135

Safety characteristics		
Max. switching frequency	[Hz]	–
Max. positive test pulse with 0 signal	[µs]	2200
Max. negative test pulse with 1 signal	[µs]	3700

Datasheet – 5/2-way valves

Operating and environmental conditions			G1/8	G1/4	G1/2	G1/8-EX	G1/4-EX	G1/2-EX
Operating medium			Compressed air to ISO 8573-1:2010 [7:4:4]					
Note on the operating/pilot medium			Lubricated operation possible (in which case lubricated operation will always be required)					
Operating pressure	Internal pilot air supply	[MPa]	0.18 ... 0.8	0.22 ... 0.8	0.2 ... 0.8	0.18 ... 0.8	0.22 ... 0.8	0.2 ... 0.8
		[bar]	1.8 ... 8	2.2 ... 8	2 ... 8	1.8 ... 8	2.2 ... 8	2 ... 8
	External pilot air supply	[MPa]	0 ... 1	0 ... 0.8	0 ... 0.8	0 ... 1	0 ... 0.8	0 ... 1
		[bar]	0 ... 10	0 ... 8	0 ... 8	0 ... 10	0 ... 8	0 ... 10
Pilot pressure (external pilot air supply)		[MPa]	0.12 ... 0.8	0.15 ... 0.8	0.15 ... 0.8	0.12 ... 0.8	0.15 ... 0.8	0.1 ... 0.8
		[bar]	1.2 ... 8	1.5 ... 8	1.5 ... 8	1.2 ... 8	1.5 ... 8	1 ... 8
Ambient temperature		[°C]	-5 ... +40					
Temperature of medium		[°C]	-10 ... +60			-5 ... +40		
Storage temperature		[°C]	-20 ... +60					
Note on materials			RoHS-compliant					
Corrosion resistance class CRC ¹⁾			1					
Certification			c UL us - Recognized (OL)			-		
LABS (PWIS) conformity			VDMA24364-B1/B2-L					

1) More information: www.festo.com/x/topic/crc

Electrical data			
F solenoid coil			
Electrical connection		Plug pins for plug sockets MSSD-F, KMF	
Operating voltage	DC voltage	[V DC]	12, 24, 42, 48
	Alternating voltage	[V AC]	24, 42, 48, 110, 230, 240 (50 ... 60 Hz)
Characteristic coil data	DC voltage	[W]	4.5
	Alternating voltage	[VA]	Pull: 7.5 Hold: 6
Degree of protection to EN 60529		IP65 (in combination with plug socket)	

Valve switching times [ms]			
Pneumatic connection	G1/8	G1/4	G1/2
On	8	9	21
Off	36	29	150

Datasheet – 5/2-way valves

Materials

Sectional view

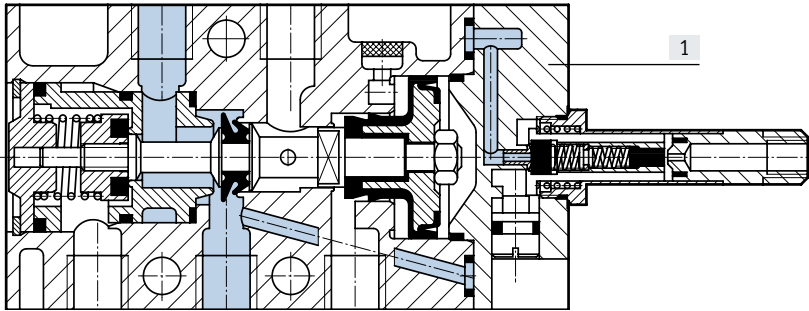

[1]	Housing	Die-cast aluminium
-	Seals	NBR, TPE-U(PU)

Datasheet – 5/2-way valves

Dimensions

Download CAD data → www.festo.com

MFH

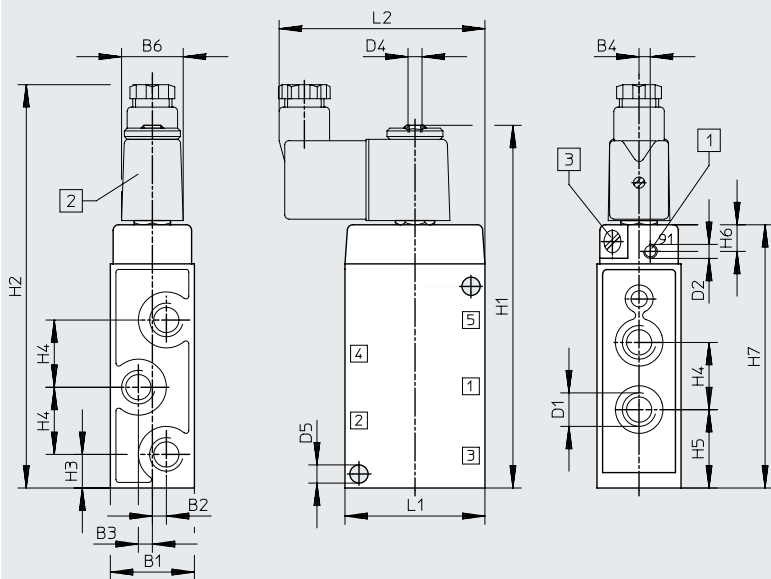

- [1] Additional connection for external pilot air with MFH-5-...-S
 [2] Solenoid coil can be rotated 360°
 [3] Manual override can be turned 180°

Type	B1	B2	B3	B4	B6	D1	D2	D4	D5 ∅
MFH-5-1/8	26 +0.2	3.5 ±0.15	3.5 ±0.15	–	22	G1/8	M5	M5	5.5
MFH-5-1/8-S		3.5	3.5	2.7					5.5 – 6.2
MFH-5-1/4	30.4 ±0.1	–	5 ±0.15	–		G1/4	M5		6.5 ±0.14
MFH-5-1/4-S				4					min.6.5
MFH-5-1/2	52 ±0.15	–	8	–		G1/2	G1/8		8.5
MFH-5-1/2-S									

Type	H1	H2	H3	H4	H5	H6	H7	L1	L2
MFH-5-1/8	117	131	13.5	19	23	–	83	45 ±0.15	71
MFH-5-1/8-S		134		19 ±0.15		9.5			71.5
MFH-5-1/4	128	143	12	24 ±0.15	28 +0.1/-0.2	–	94	50 +0.4/-0.2	73.5
MFH-5-1/4-S						9.5			
MFH-5-1/2	192	208.5	32 ±0.15	38 ±0.15	51 ±0.15	–	158	80 +0.4/-0.2	87.5
MFH-5-1/2-S						10.5			

Datasheet – 5/2-way valves

Dimensions

Download CAD data → www.festo.com

Mounting diagram

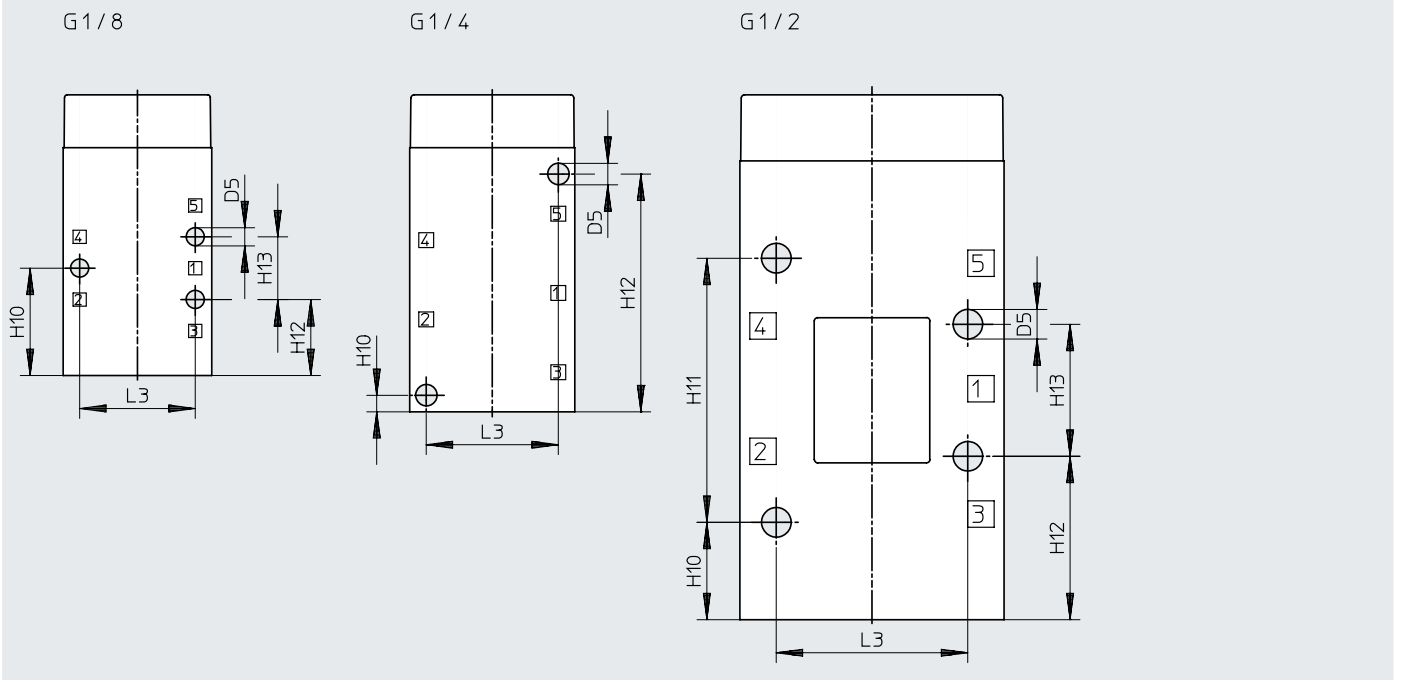

Type	D5 ø	H10	H11	H12	H13	L3
MFH-5-1/8	5.5	32.5	-	23	19 ±0.15	35 ±0.15
MFH-5-1/8-S	5.5 – 6.2					
MFH-5-1/4	6.5 ±0.14	5	-	72	-	40 ±0.15
MFH-5-1/4-S	min.6.5					
MFH-5-1/2	8.5	29.5	80 ±0.15	49.5	40 ±0.1	58 ±0.15
MFH-5-1/2-S						

Datasheet – 5/2-way valves



Ordering data					
Circuit symbol	Description	Pneumatic connection	ATEX category	Part no.	Type
	Without F solenoid coil ¹⁾ , internal pilot air supply	G1/8	–	9982	MFH-5-1/8
			ATEX category → Page 12	535906	MFH-5-1/8-EX
		G1/4	–	6211	MFH-5-1/4
			ATEX category → Page 12	535907	MFH-5-1/4-EX
		G1/2	–	6420	MFH-5-1/2
			ATEX category → Page 12	535908	MFH-5-1/2-EX
	Without F solenoid coil ¹⁾ , external pilot air supply	G1/8	–	10348	MFH-5-1/8-S
			ATEX category → Page 12	535909	MFH-5-1/8-S-EX
		G1/4	–	10349	MFH-5-1/4-S
			ATEX category → Page 12	535910	MFH-5-1/4-S-EX
		G1/2	–	35547	MFH-5-1/2-S
			ATEX category → Page 12	535911	MFH-5-1/2-S-EX

1) F solenoid coils → page 50

Ordering data – Sets of wearing parts		
Pneumatic connection	Part no.	Type
G1/8	104209	MFH-5-1/8¹⁾²⁾
G1/4	104211	MFH-5-1/4³⁾⁴⁾

- 1) Order assembly sleeve part no. 228389 separately
- 2) Use up to series E602
- 3) Order assembly sleeve part no. 229363 separately
- 4) Use from series 1/81

Datasheet – 5/2-way valves, double solenoid valves

-  Flow rate
600 ... 4500 l/min
-  Voltage
12, 24, 42, 48 V DC
24, 42, 48, 110, 230,
240 V AC

Sets of wearing parts → page 29



General technical data				
Pneumatic connection	G1/8	G1/4	G1/2	
Valve function	5/2-way, double solenoid			
Design	Poppet seat			
Overlap	Negative overlap			
Sealing principle	Soft			
Actuation type	Electrical			
Type of control	Piloted			
Flow direction	Not reversible			
Pilot air supply	Internal or external			
Exhaust air function	Can be throttled			
Manual override	Detenting			
Type of mounting	Via through-hole or on manifold rail/manifold block			
Mounting position	Any			
Electrical connection	Via F solenoid coil, to be ordered separately			
Connection for venting hole	M5 (only ATEX types)			
b value	–	–	0.3	
c value	[l/sbar]	–	19.5	
Pilot exhaust air port 82/84	M5			
Pilot air port 12/14	M5	M5	G1/2	
Nominal width	[mm]	5	7	14
Standard nominal flow rate	[l/min]	600	1100	4500
Product weight	[g]	260	530	1210

Safety characteristics			
Type		JMFH- ... -EX	JMFDH- ... -EX
Max. switching frequency	[Hz]	25	16
Max. positive test pulse with 0 signal	[µs]	2200	
Max. negative test pulse with 1 signal	[µs]	3700	

Datasheet – 5/2-way valves, double solenoid valves

Operating and environmental conditions			G1/8	G1/4	G1/2	G1/8-EX	G1/4-EX	G1/2-EX	
Pneumatic connection									
Operating medium			Compressed air to ISO 8573-1:2010 [7:4:4]						
Note on the operating/pilot medium			Lubricated operation possible (in which case lubricated operation will always be required)						
Operating pressure	Internal pilot air supply	[MPa]	0.15 ... 0.8		0.2 ... 0.8		0.15 ... 0.8		
		[bar]	1.5 ... 8		2 ... 8		1.5 ... 8		
	External pilot air supply	[MPa]	0 ... 1		0 ... 0.8		0 ... 1		
		[bar]	0 ... 10		0 ... 8		0 ... 10		
	With dominant signal	[MPa]	0.25 ... 0.8		–		0.25 ... 0.8		
		[bar]	2.5 ... 8		–		2.5 ... 8		
Pilot pressure	[MPa]	0.12 ... 0.8		0.05 ... 0.8		0.12 ... 0.8			
	[bar]	1.2 ... 8		0.5 ... 8		1.2 ... 8			
Ambient temperature	[°C]	–5 ... +40							
Temperature of medium	[°C]	–10 ... +60				–5 ... +40			
Storage temperature	[°C]	–20 ... +60							
Certification		c UL us - Recognized (OL)				–			
Note on materials		RoHS-compliant							
Corrosion resistance class CRC ¹⁾		1							
LABS (PWIS) conformity		VDMA24364-B1/B2-L							

1) More information: www.festo.com/x/topic/crc

Electrical data

F solenoid coil			
Electrical connection		Plug pins for plug sockets MSSD-F, KMF	
Operating voltage	DC voltage	[V DC]	12, 24, 42, 48
	Alternating voltage	[V AC]	24, 42, 48, 110, 230, 240 (50 ... 60 Hz)
Characteristic coil data	DC voltage	[W]	4.5
	Alternating voltage	[VA]	Pull: 7.5 Hold: 6
Degree of protection to EN 60529		IP65 (in combination with plug socket)	

Valve switching times [ms]

Pneumatic connection	G1/8		G1/4		G1/2	
		Dominant signal at 14		Dominant signal at 14		Dominant signal at 14
Changeover	10	16	11	16	20	–

Datasheet – 5/2-way valves, double solenoid valves

Materials

Sectional view

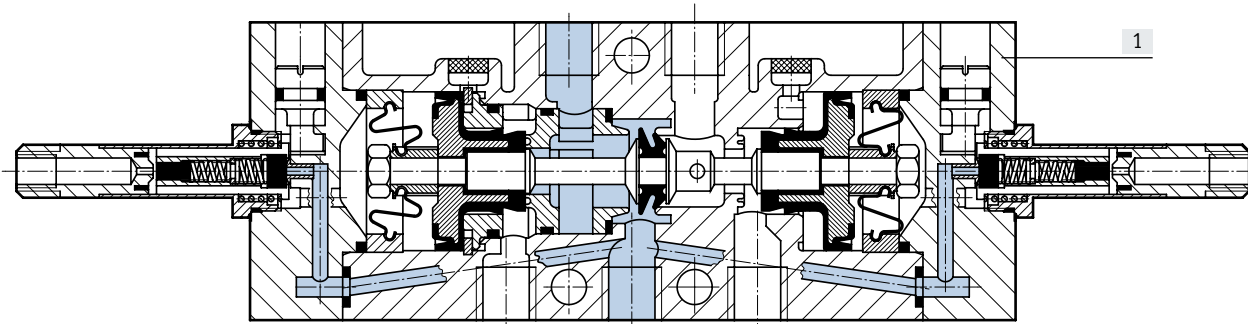

[1]	Housing	Die-cast aluminium
-	Seals	NBR, TPE-U(PU)

Datasheet – 5/2-way valves, double solenoid valves

Dimensions

Download CAD data → www.festo.com

JMFH, JMFDH

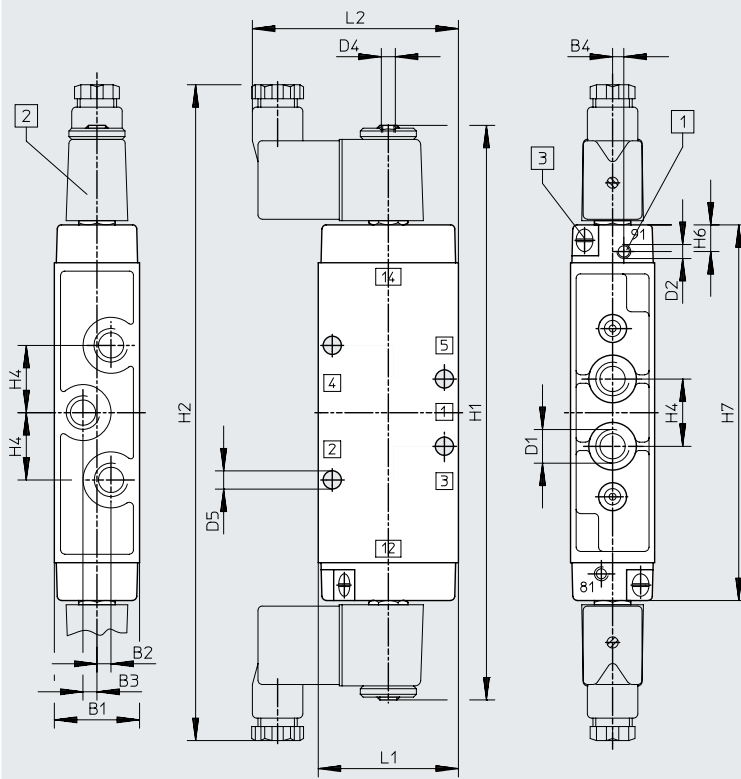

- [1] Additional connection for external pilot air with JMF...H-5-...-S
- [2] Solenoid coil can be rotated 360°
- [3] Manual override can be turned 180°



Type	B1	B2	B3	B4	D1	D2	D4	D5 ∅
JMF...-5-1/8	26 +0.2	3.5 +0.15	3.5 +0.15	–	G1/8	–	M5	5.5
JMF...-5-1/8-S				2.7		M5		
JMF...-5-1/4	30.4 ±0.1	–	5	–	G1/4	–	M5	Min. 6.5
JMF...-5-1/4-S				4		M5		
JMF...-5-1/2	52	–	8	–	G1/2	–	M5	9.6 +0.2
JMF...-5-1/2-S	52 ±0.15					G1/8		8.5

Type	H1	H2	H4	H6	H7	L1	L2
JMF...-5-1/8	184	217	19 ±0.15	–	116.5	45 ±0.15	71.5
JMF...-5-1/8-S				9.5			
JMF...-5-1/4	202	235	24 -0.3	–	134	50 +0.4/-0.2	74
JMF...-5-1/4-S				9.5			
JMF...-5-1/2	244	272	38	–	176	80	88.5
JMF...-5-1/2-S		277					

Datasheet – 5/2-way valves, double solenoid valves

Dimensions

Download CAD data → www.festo.com

Mounting diagram

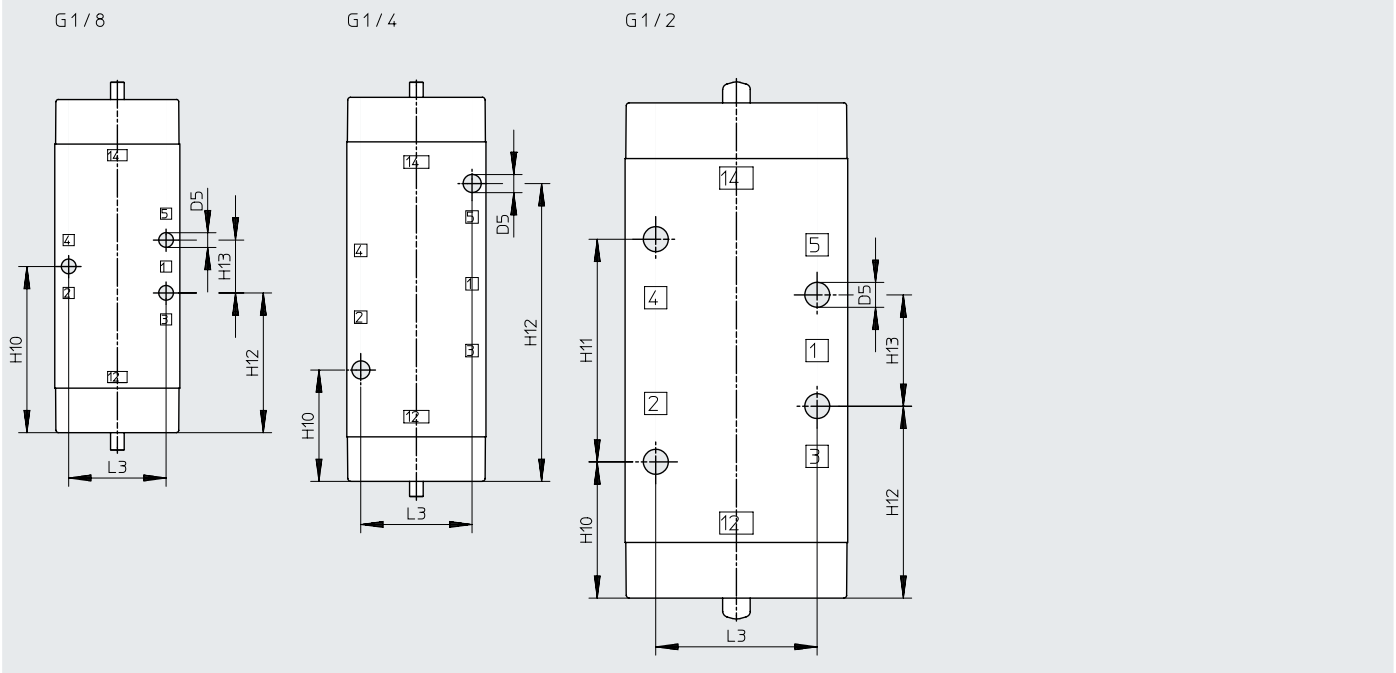

Type	D5 ∅	H10	H12	H13	L3
JME...-5-1/8	5.5	19	58.3	-	35
JME...-5-1/8-S					
JME...-5-1/4	Min. 6.5	67	67	-	40
JME...-5-1/4-S					
JME...-5-1/2	9.6 +0.2	40	88	80	58
JME...-5-1/2-S	8.5				

Datasheet – 5/2-way valves, double solenoid valves

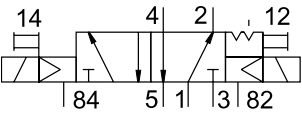
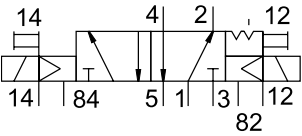
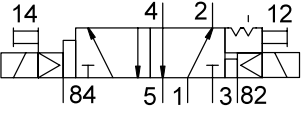
Ordering data					
Circuit symbol	Description	Pneumatic connection	ATEX category	Part no.	Type
	Without F solenoid coil ¹⁾ , internal pilot air supply	G1/8	–	8820	JMFH-5-1/8
			ATEX category → Page 12	535912	JMFH-5-1/8-EX
		G1/4	–	10410	JMFH-5-1/4
			ATEX category → Page 12	535913	JMFH-5-1/4-EX
		G1/2	–	10166	JMFH-5-1/2
			ATEX category → Page 12	535914	JMFH-5-1/2-EX
	Without F solenoid coil ¹⁾ , external pilot air supply	G1/8	–	14008	JMFH-5-1/8-S
			ATEX category → Page 12	535915	JMFH-5-1/8-S-EX
		G1/4	–	14009	JMFH-5-1/4-S
			ATEX category → Page 12	535916	JMFH-5-1/4-S-EX
		G1/2	–	35548	JMFH-5-1/2-S
			ATEX category → Page 12	535917	JMFH-5-1/2-S-EX
	Without F solenoid coil ¹⁾ , internal pilot air supply, With dominant signal at 14	G1/8	–	8821	JMFDH-5-1/8
			ATEX category → Page 12	536193	JMFDH-5-1/8-EX
		G1/4	–	10411	JMFDH-5-1/4
			ATEX category → Page 12	536194	JMFDH-5-1/4-EX

1) F solenoid coils → page 50

Ordering data – Sets of wearing parts		
Pneumatic connection	Part no.	Type
G1/8	104891	JMFH-5-1/8¹⁾
G1/4	104892	JMFH-5-1/4²⁾

1) Order assembly sleeve part no. 228389 separately

2) Order assembly sleeve part no. 229363 separately

Peripherals overview: Pneumatic valves

Mounting on manifold block

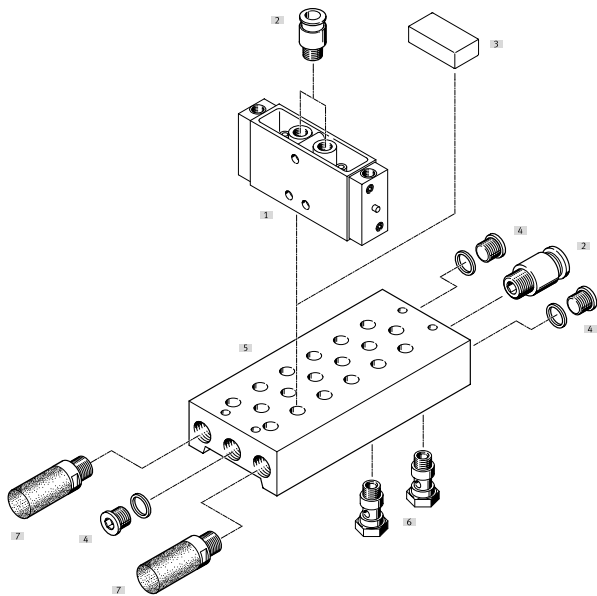

Mounting on manifold rail

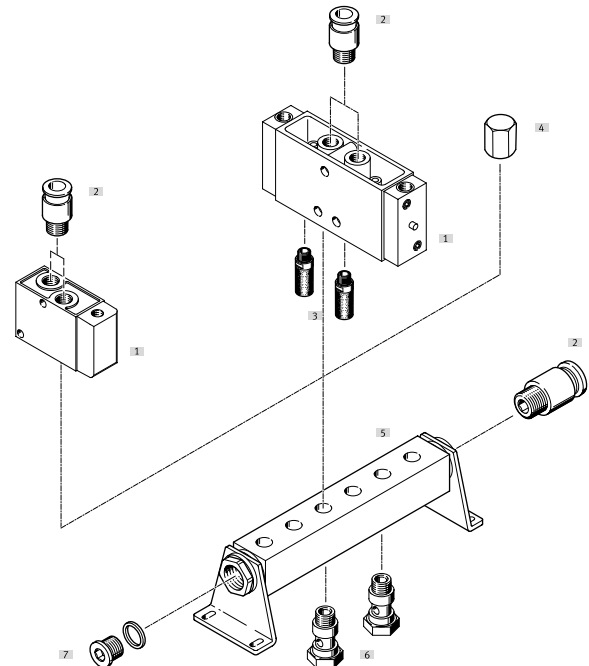

Accessories		Brief description	→ Page/Internet
[1]	Pneumatic valve VL, JH	–	–
[2]	Push-in fitting QS	For connecting tubing with standard O.D.	quick star
[3]	Cover plate PRSB	For covering a vacant position	49
[4]	blanking plug B	3 included in the scope of delivery of the manifold block PRS 1 included in the scope of delivery of the manifold rail PAL	blanking plug
[5]	Manifold block PRS	–	48
[6]	Hollow bolt VT	For distributing compressed air or for separate compressed air supply	47
[7]	Silencer	For mounting in exhaust ports	u

Accessories		Brief description	→ Page/Internet
[1]	Pneumatic valve VL, JH	–	–
[2]	Push-in fitting QS	For connecting tubing with standard O.D.	quick star
[3]	Silencer	For mounting in exhaust ports	u
[4]	Cap nut VTM	For blanking a vacant position	47
[5]	Manifold rail PAL	–	46
[6]	Hollow bolt VT	For distributing compressed air or for separate compressed air supply	47
[7]	Blanking plug B	3 included in the scope of delivery of the manifold block PRS 1 included in the scope of delivery of the manifold rail PAL	blanking plug

Datasheet – 3/2-way valves

-  - Flow rate
500 ... 7500 l/min

Sets of wearing parts → page 36

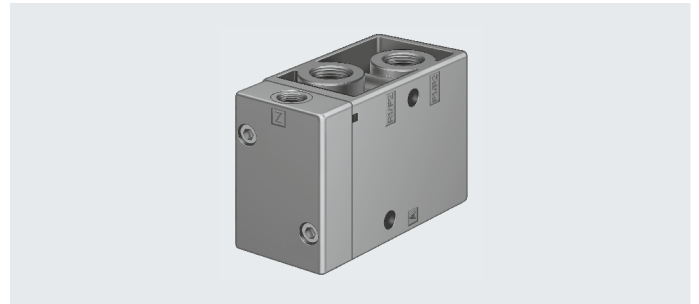

General technical data		G1/8	G1/4	G1/2	G3/4
Pneumatic connection		G1/8	G1/4	G1/2	G3/4
Valve function		3/2-way, monostable			
Design		Poppet seat			
Overlap		Negative overlap			
Sealing principle		Soft			
Actuation type		Pneumatic			
Reset method		Mechanical spring			
Type of control		Direct			
Pilot air supply		External			
Flow direction		Reversible with restrictions			
Exhaust air function		Can be throttled			
Manual override		None			
Type of mounting		Via through-hole or on manifold rail/manifold block			
Mounting position		Any			
Connection for venting hole		M5 (only ATEX types)			
Pilot air port 110/12		G1/8	G1/8	G1/4	G1/4
b value		–	–	0.3	–
Nominal width	[mm]	5	7	14	19
Standard nominal flow rate	[l/min]	500	800	3700	7500
Product weight	[g]	150	230	860	1200

Safety characteristics		G1/8	G1/4	G1/2	G3/4
Type		G1/8	G1/4	G1/2	G3/4
Max. switching frequency	[Hz]	12	–	–	–
Max. positive test pulse with 0 signal	[µs]	2200	–	–	–
Max. negative test pulse with 1 signal	[µs]	3700	–	–	–

ATEX		VL ... -EX, J- ... -EX
Type		VL ... -EX, J- ... -EX
ATEX category for gas		II 2G
Type of ignition protection for gas		Ex h IIC T4 Gb
ATEX category for dust		II 2D
Type of ignition protection for dust		Ex h IIIC T130°C Db
Explosion-proof ambient temperature	[°C]	–10°C ≤ Ta ≤ +60°C
CE marking (see declaration of conformity)		To EU Explosion Protection Directive (ATEX)
UKCA marking (see declaration of conformity)		According to UK explosion regulations
Explosion protection certification outside the EU		EPL Db (GB) EPL Gb (GB)

Datasheet – 3/2-way valves

Operating and environmental conditions			G1/8	G1/4	G1/2	G3/4
Pneumatic connection						
Operating medium			Compressed air to ISO 8573-1:2010 [7:4:4]			
Pilot medium			Compressed air to ISO 8573-1:2010 [7:4:4]			
Note on the operating/pilot medium			Lubricated operation possible (in which case lubricated operation will always be required)			
Operating pressure	Normally closed	[MPa]	-0.095 ... 1			
		[bar]	-0.95 ... 10			
	Normally open	[bar]	0 ... 10			
Pilot pressure		[MPa]	0.1 ... 1			
		[bar]	1 ... 10			
			See diagram (max. 10 bar)			
Ambient temperature			[°C]	-10 ... +60		
Temperature of medium			[°C]	-10 ... +60		
Storage temperature			[°C]	-20 ... +60		
Note on materials			RoHS-compliant			
Corrosion resistance class CRC ¹⁾			1			
LABS (PWIS) conformity			VDMA24364-B1/B2-L			

1) More information: www.festo.com/x/topic/crc

Valve switching times [ms]		G1/8	G1/4	G1/2	G3/4
Pneumatic connection					
On		4	7	17	12
Off		10	26	30	35

Datasheet – 3/2-way valves

Minimum pilot pressure $p_{12}/p_{14}/p_{110}$ as a function of operating pressure p_1/p_{11}

VL/O-3-1/8 – normally closed

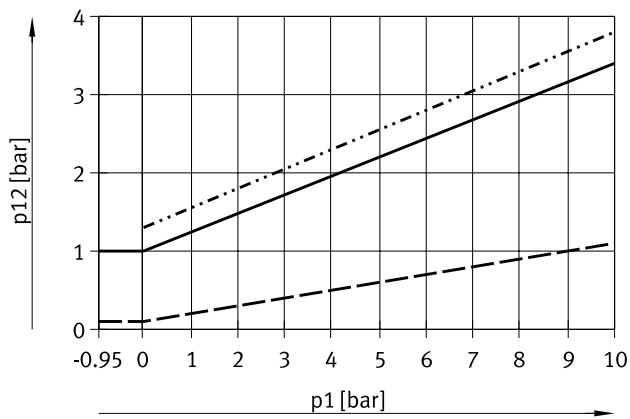

— Switch-on pressure
 - · - · - Exhaust air flow control
 - - - Switch-off pressure

VL/O-3-1/8 – normally open

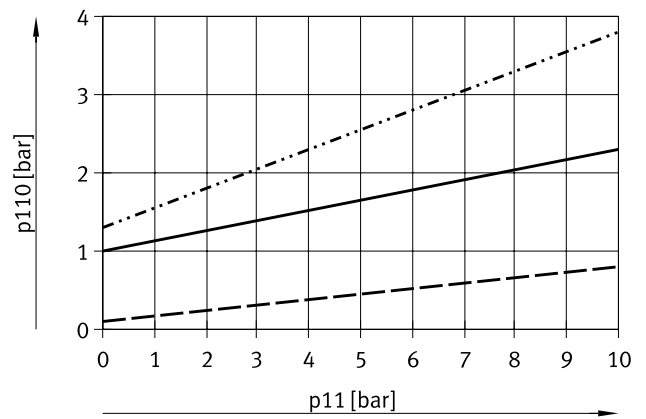

— Switch-on pressure
 - · - · - Exhaust air flow control
 - - - Switch-off pressure

VL/O-3-1/4 – normally closed

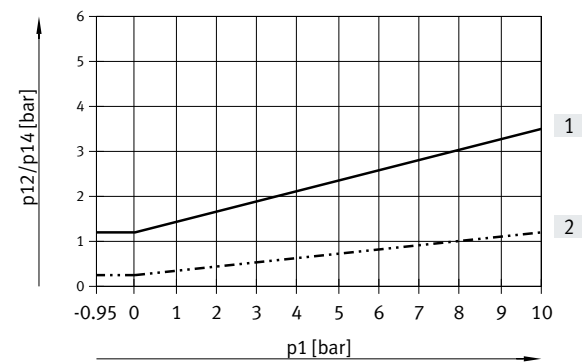

[1] Switch-on pressure
 [2] Switch-off pressure

VL/O-3-1/4 – normally open

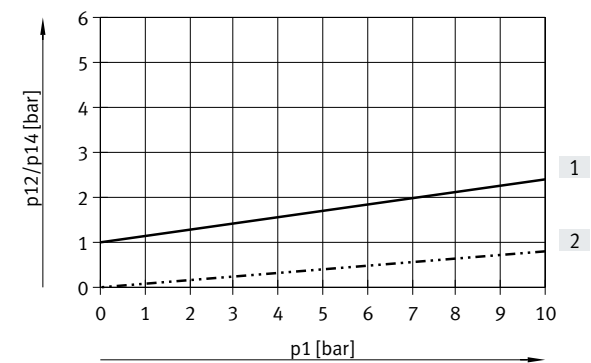

[1] Switch-on pressure
 [2] Switch-off pressure

VL/O-3-1/2 – normally closed

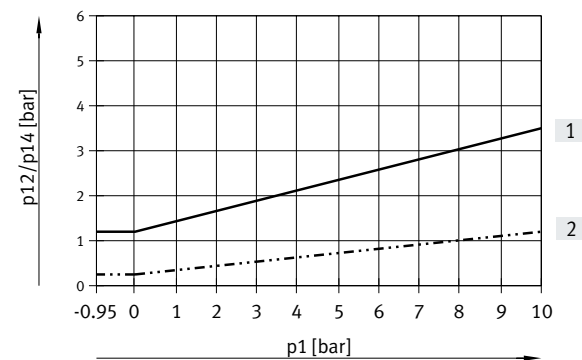

[1] Switch-on pressure
 [2] Switch-off pressure

VL/O-3-1/2 – normally open

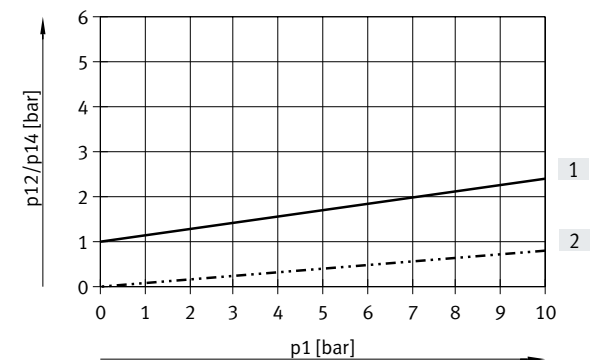

[1] Switch-on pressure
 [2] Switch-off pressure

Datasheet – 3/2-way valves

VL/O-3-3/4 – normally closed

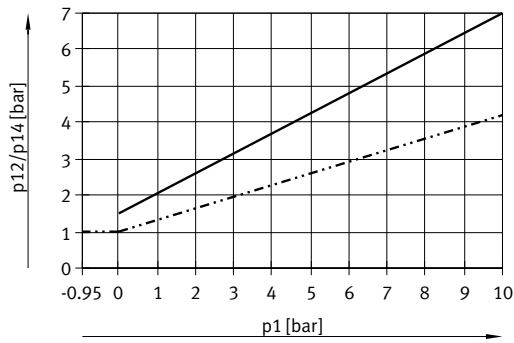

— Exhaust throttled
 - - - - - Exhaust unthrottled

VL/O-3-3/4 – normally open

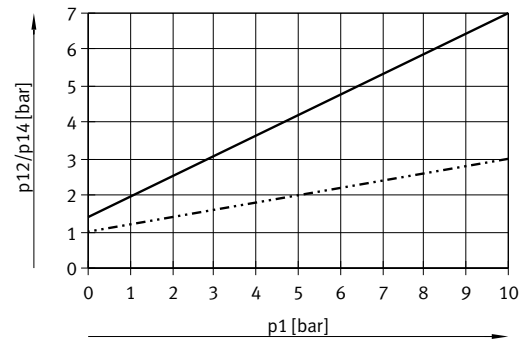

— Exhaust throttled
 - - - - - Exhaust unthrottled

Materials

Sectional view

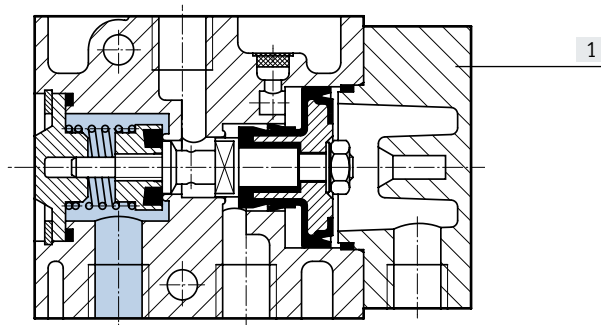

[1]	Housing	Die-cast aluminium
-	Seals	NBR

Datasheet – 3/2-way valves

Dimensions

Download CAD data → www.festo.com

VL/O

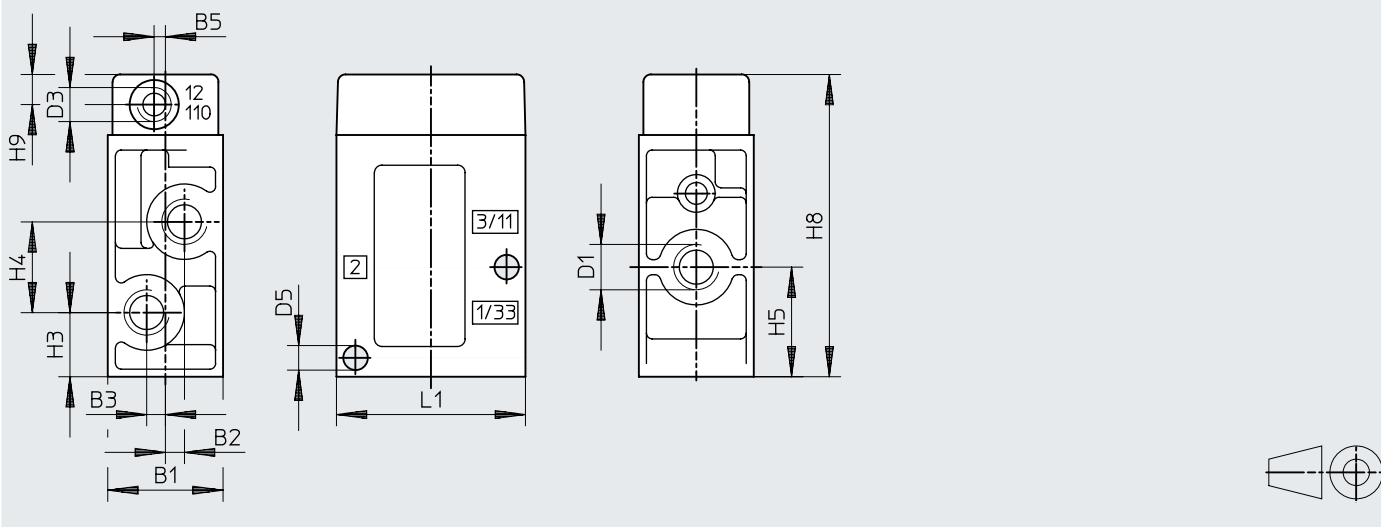

Type	B1	B2	B3	B5	D1	D3	D5 ∅	H3	H4	H5	H8	H9	L1
VL/O-3-1/8	26	3.5	3.5	3	G1/8	G1/8	5.5	12.5	19	22	65	8	45
VL/O-3-1/4	30.4	5	5	-	G1/4	G1/8	6.5	17	24	29	80	8	50
VL/O-3-1/2	52	8	8	-	G1/2	G1/4	8.6	30	38	49	118	10	80
VL/O-3-3/4	68	8	8	-	G3/4	G1/4	8.6	34	44	56	138	10	92

Mounting diagram

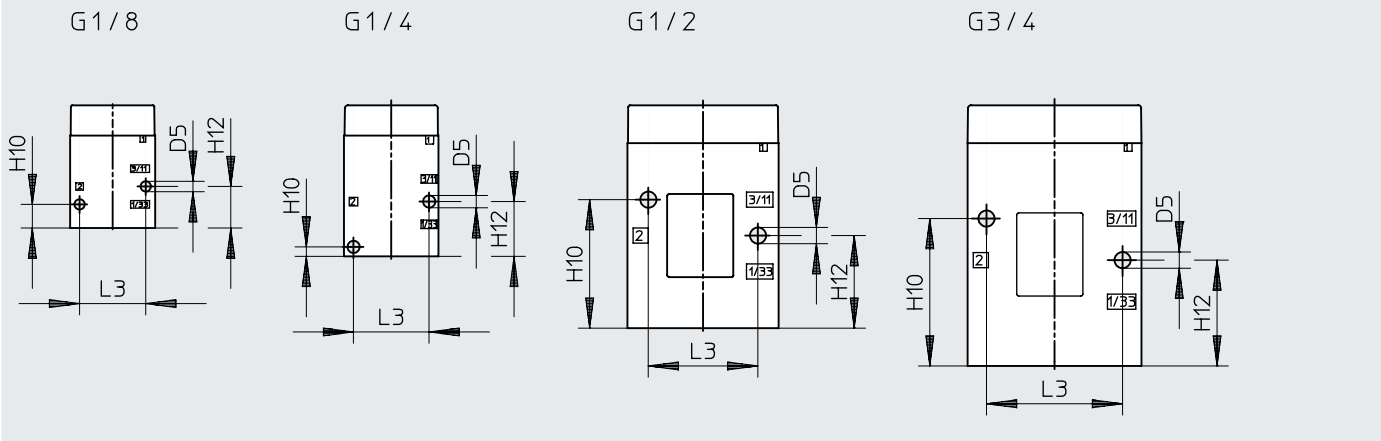

Type	D5 ∅	H10	H12	L3
VL/O-3-1/8	5.5	12.5	22	35 ±0.15
VL/O-3-1/4	6.5	5	29	40 ±0.15
VL/O-3-1/2	8.6	68	49	58 ±0.2
VL/O-3-3/4	8.6	78	56	72 ±0.2

Datasheet – 3/2-way valves

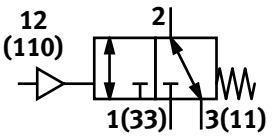
Ordering data					
Circuit symbol	Description	Pneumatic connection	ATEX category	Part no.	Type
	Mechanical reset method, optionally normally open or normally closed reversible (no restrictions with vacuum at port 1, restrictions with vacuum at port 3)	G1/8 ¹⁾	–	7803	VL/O-3-1/8-B
			ATEX category → Page 12	536028	VL/O-3-1/8-B-EX
		G1/4 ²⁾	–	9984	VL/O-3-1/4
			ATEX category → Page 12	536029	VL/O-3-1/4-EX
		G1/2 ³⁾	–	9983	VL/O-3-1/2
			ATEX category → Page 12	536030	VL/O-3-1/2-EX
		G3/4 ⁴⁾	–	10049	VL/O-3-3/4
			ATEX category → Page 12	536031	VL/O-3-3/4-EX

- 1) Restrictions with vacuum at port 3: (0 ... –0.7 bar)
- 2) Restrictions with vacuum at port 3: (0 ... –0.6 bar)
- 3) Restrictions with vacuum at port 3: (0 ... –0.55 bar)
- 4) Restrictions with vacuum at port 3: (0 ... –0.4 bar)

Ordering data – Sets of wearing parts			
Pneumatic connection		Part no.	Type
G1/8		104222	VL/O-3-1/8-B
G1/4		104207	VL/O-3-1/4
G1/2		104208	VL/O-3-1/2

Datasheet – 5/2-way valves

-  - Flow rate
500 ... 3700 l/min

Sets of wearing parts → page 40



General technical data				
Pneumatic connection	G1/8	G1/4	G1/2	
Valve function	5/2-way, monostable			
Design	Poppet seat			
Overlap	Negative overlap			
Sealing principle	Soft			
Actuation type	Pneumatic			
Reset method	Mechanical spring			
Type of control	Direct			
Pilot air supply	External			
Flow direction	Not reversible			
Manual override	None			
Exhaust air function	Can be throttled			
Type of mounting	Via through-hole or on manifold rail/manifold block			
Mounting position	Any			
Connection for venting hole	M5 (only ATEX types)			
Pilot air port 14	G1/8	G1/8	G1/4	
b value	–	–	0.32	
c value	[l/sbar]	–	17.65	
Nominal width	[mm]	5	7	14
Standard nominal flow rate	[l/min]	500	800	3700
Product weight	[g]	220	220	1070

Safety characteristics				
Type	G1/8	G1/4	G1/2	
Max. switching frequency	[Hz]	12	–	–
Max. positive test pulse with 0 signal	[µs]	2200		
Max. negative test pulse with 1 signal	[µs]	3700		

Operating and environmental conditions				
Pneumatic connection	G1/8	G1/4	G1/2	
Operating medium	Compressed air to ISO 8573-1:2010 [7:4:4]			
Pilot medium	Compressed air to ISO 8573-1:2010 [7:4:4]			
Note on the operating/pilot medium	Lubricated operation possible (in which case lubricated operation will always be required)			
Operating pressure	[MPa]	0 ... 1	0 ... 0.8	0 ... 1
	[bar]	0 ... 10	0 ... 8	0 ... 10
Pilot pressure	[MPa]	0.12 ... 1		
	[bar]	1.2 ... 10		
		See diagram (max. 10 bar)		
Ambient temperature	[°C]	–10 ... +60		
Temperature of medium	[°C]	–10 ... +60		
Storage temperature	[°C]	–20 ... +60		
Note on materials	RoHS-compliant			
Corrosion resistance class CRC ¹⁾	1			
LABS (PWIS) conformity	VDMA24364-B1/B2-L			

1) More information: www.festo.com/x/topic/crc

Datasheet – 5/2-way valves

Minimum pilot pressure p_{12}/p_{14} as a function of operating pressure p_1

VL-5-1/8

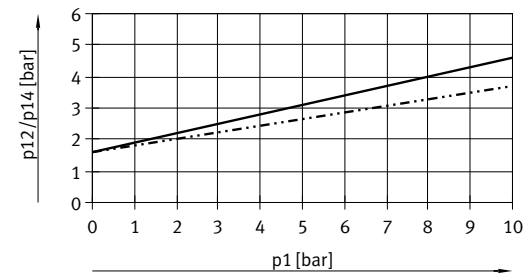

VL-5-1/4

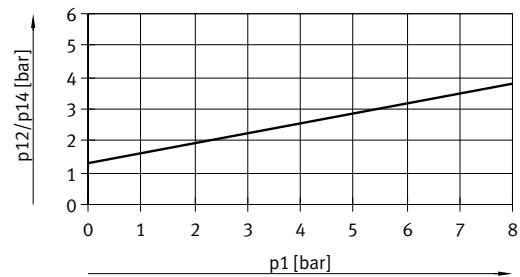

- Exhaust throttled
- - - - - Exhaust unthrottled

VL-5-1/2

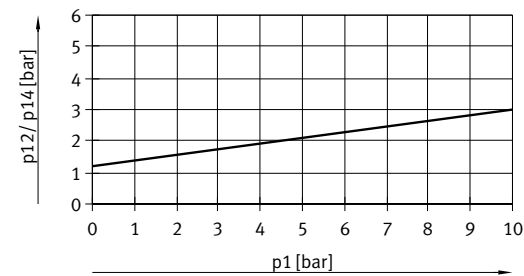

Valve switching times [ms]

Pneumatic connection	G1/8	G1/4	G1/2
On	5	7	3
Off	16	11	27

Materials

Sectional view

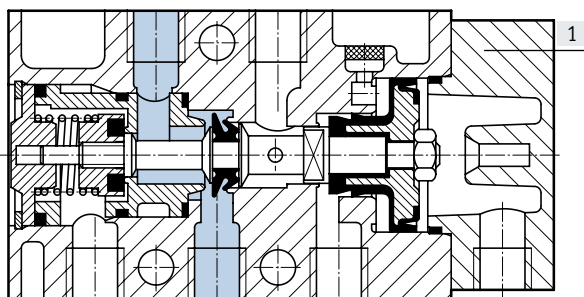

[1]	Housing	Die-cast aluminium
-	Seals	NBR, TPE-U(PU)

Datasheet – 5/2-way valves

Dimensions

Download CAD data → www.festo.com

VL

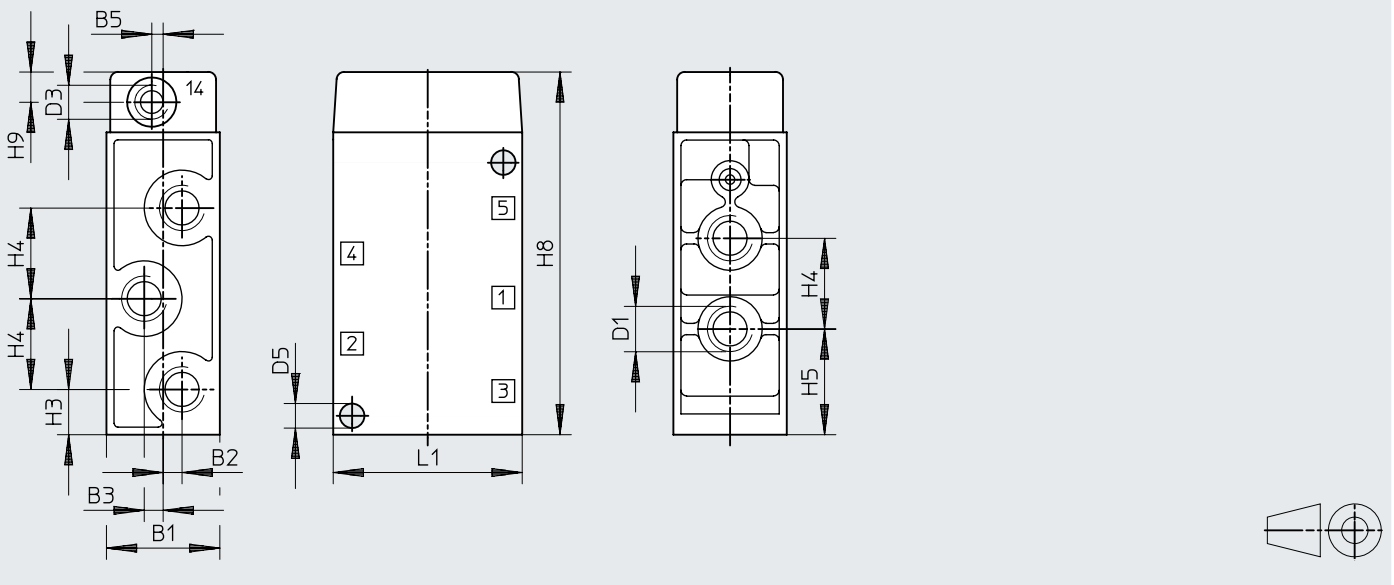

Type	B1	B2	B3	B5	D1	D3	D5 ∅	H3	H4	H5	H8	H9	L1
VL-5-1/8	26	3.5	3.5	3	G1/8	G1/8	5.5	13.5	19	23	85	8	45
VL-5-1/4	30.4 ±0.1	–	5.2	–	G1/4	G1/8	6.5	12	24	28	96	8	50
VL-5-1/2	52	–	8	–	G1/2	G1/4	9	32	38	51	159	10	80

Mounting diagram

G 1/8

G 1/4

G 1/2

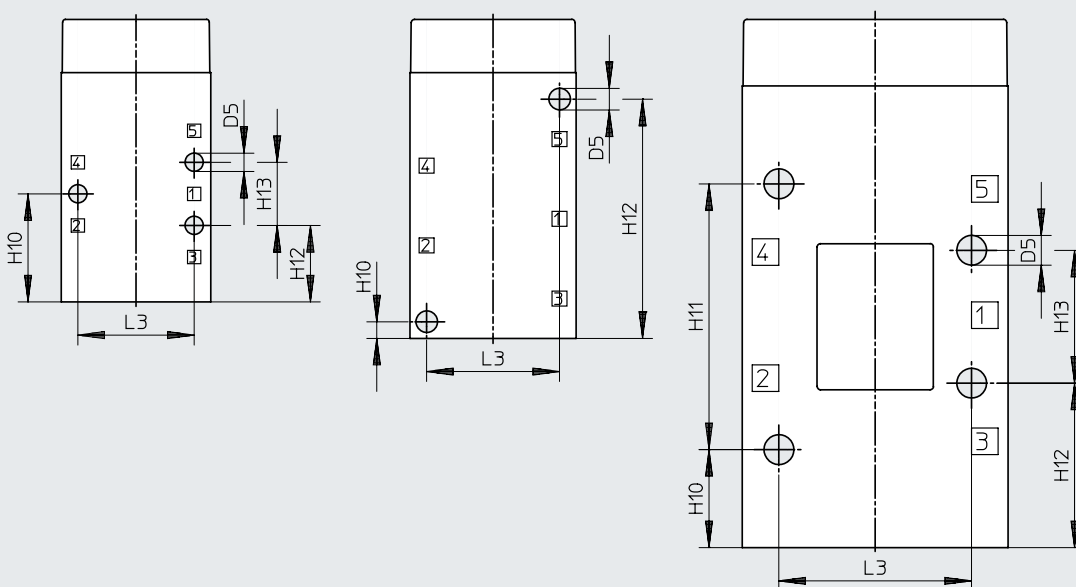

Type	D5 ∅	H10	H11	H12	H13	L3
VL-5-1/8	5.5	32.5	–	23	19 ±0.15	35 ±0.15
VL-5-1/4	6.5	5	–	72	–	40 ±0.15
VL-5-1/2	9	29.5	80 ±0.15	49.5	40 ±0.1	58 ±0.15

Datasheet – 5/2-way valves

Ordering data					
Circuit symbol	Description	Pneumatic connection	ATEX category	Part no.	Type
	Mechanical reset method	G1/8	–	9764	VL-5-1/8
			ATEX category → Page 12	536032	VL-5-1/8-EX
		G1/4	–	9199	VL-5-1/4
			ATEX category → Page 12	536033	VL-5-1/4-EX
		G1/2	–	9445	VL-5-1/2
			ATEX category → Page 12	536034	VL-5-1/2-EX

Ordering data – Sets of wearing parts		
Pneumatic connection	Part no.	Type
G1/8	104209	VL-5-1/8 ¹⁾
G1/4	104211	VL-5-1/4 ²⁾³⁾
G1/2	104212	VL-5-1/2

- 1) Order assembly sleeve part no. 228389 separately
- 2) Order assembly sleeve part no. 229363 separately
- 3) Use from series 1/81

Datasheet – 5/2-way valves, double pilot valves

-  - Flow rate
600 ... 4500 l/min

Sets of wearing parts → page 45



General technical data		G1/8	G1/4	G1/2
Pneumatic connection		G1/8	G1/4	G1/2
Valve function		5/2-way, bistable		
Design		Poppet seat		
Overlap		Negative overlap		
Sealing principle		Soft		
Actuation type		Pneumatic		
Type of control		Direct		
Pilot air supply		External		
Flow direction		Not reversible		
Exhaust air function		Can be throttled		
Manual override		–	–	Detenting
Type of mounting		Via through-hole or on manifold rail/manifold block		
Mounting position		Any		
Connection for venting hole		M5 (only ATEX types)		
Pilot air port 12/14		G1/8	G1/8	G1/4
b value		–	–	0.3
Nominal width	[mm]	5	7	14
Standard nominal flow rate	[l/min]	600	1100	4500
Product weight	[g]	330	330	1130

Safety characteristics		G1/8	G1/4	G1/2
Type		G1/8	G1/4	G1/2
Max. switching frequency	[Hz]	12		
Max. positive test pulse with 0 signal	[μs]	2200		
Max. negative test pulse with 1 signal	[μs]	3700		

Operating and environmental conditions		G1/8	G1/4	G1/2	
Pneumatic connection		G1/8	G1/4	G1/2	
Operating medium		Compressed air to ISO 8573-1:2010 [7:4:4]			
Pilot medium		Compressed air to ISO 8573-1:2010 [7:4:4]			
Note on the operating/pilot medium		Lubricated operation possible (in which case lubricated operation will always be required)			
Operating pressure	[MPa]	0 ... 1	0 ... 0.8	0 ... 1	
	[bar]	0 ... 10	0 ... 8	0 ... 10	
	With dominant signal	[MPa]	0 ... 1	0 ... 0.8	–
		[bar]	0 ... 10	0 ... 8	–
Pilot pressure	[MPa]	0.12 ... 1			
	[bar]	1.2 ... 10			
		See diagram (max. 10 bar)			
	With dominant signal	[MPa]	0.23 ... 1	–	–
[bar]		2.3 ... 10	–	–	
Ambient temperature	[°C]	–10 ... +60			
Temperature of medium	[°C]	–10 ... +60			
Storage temperature	[°C]	–20 ... +60			
Note on materials		RoHS-compliant			
Corrosion resistance class CRC ¹⁾		1			
LABS (PWIS) conformity		VDMA24364-B1/B2-L			

1) More information: www.festo.com/x/topic/crc

Datasheet – 5/2-way valves, double pilot valves

Minimum pilot pressure p_{12}/p_{14} as a function of operating pressure p_1

JH-5-1/8

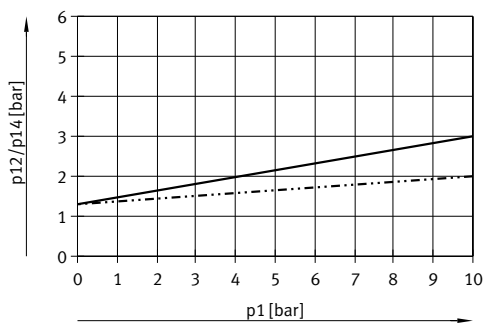

— Exhaust throttled
- - - Exhaust unthrottled

JDH-5-1/8

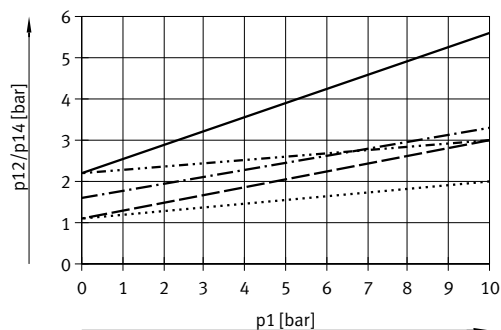

— Exhaust throttled
- - - Exhaust unthrottled

JH-5-1/4

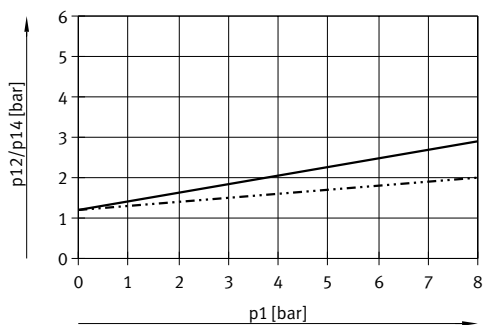

— Exhaust throttled
- - - Exhaust unthrottled

JDH-5-1/4

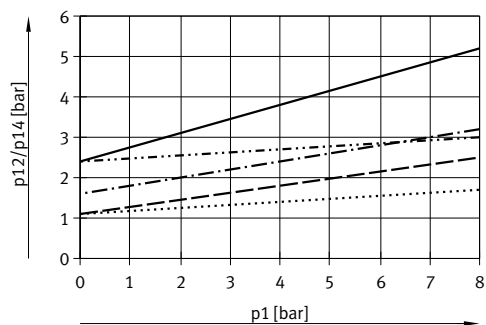

— Exhaust throttled
- - - Exhaust unthrottled

JH-5-1/2

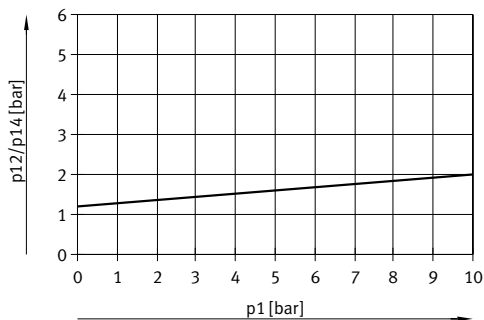

Valve switching times [ms]

Pneumatic connection	G1/8		G1/4		G1/2	
		Dominant signal at 14		Dominant signal at 14		Dominant signal at 14
Changeover	7	7	7	12	3	–

Datasheet – 5/2-way valves, double pilot valves

Materials

Sectional view

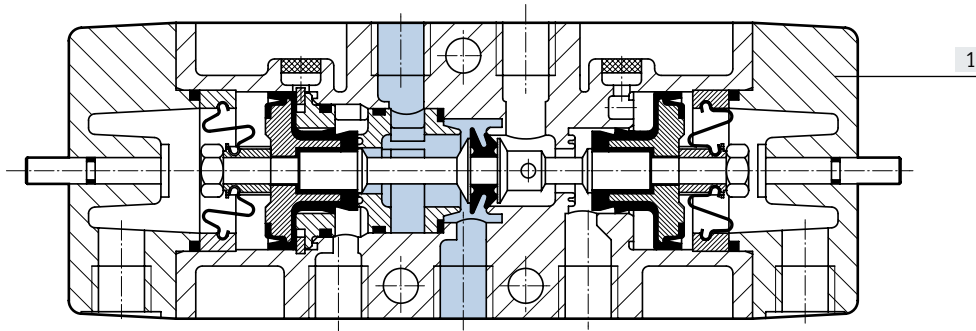

[1] Housing	Die-cast aluminium
- Seals	NBR, TPE-U(PU)

Dimensions

Download CAD data → www.festo.com

JH, JDH

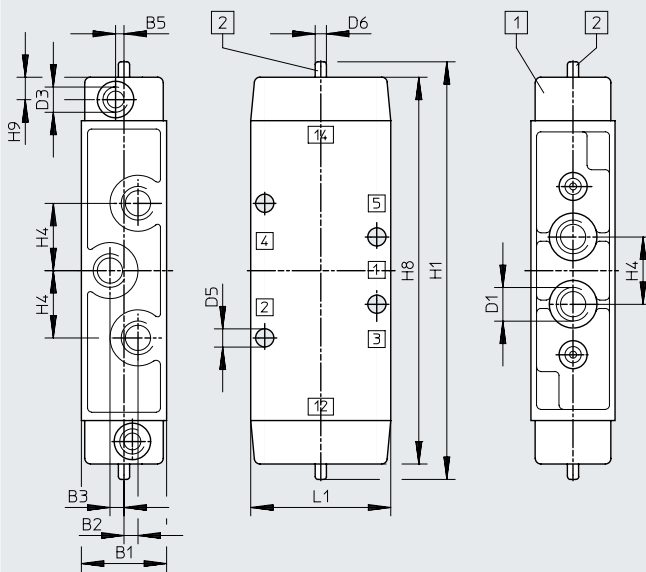

[4] Cover can be turned 180°

[5] Manual override

Type	B1	B2	B3	B5	D1	D3	D5 ∅	D6 ∅	H1	H4	H8	H9	L1
J...-5-1/8	26	3.5	3.5	3	G1/8	G1/8	5.3	5	132	19	120	8	45
J...-5-1/4	30.4	-	5	-	G1/4	G1/8	6.5	5	149	24	138	8	50
J...-5-1/2	52	-	8	-	G1/2	G1/4	9.6 +0.2	9.9	193	38	178	10	80

Datasheet – 5/2-way valves, double pilot valves

Dimensions

Download CAD data → www.festo.com

Mounting diagram

G 1/8

G 1/4

G 1/2

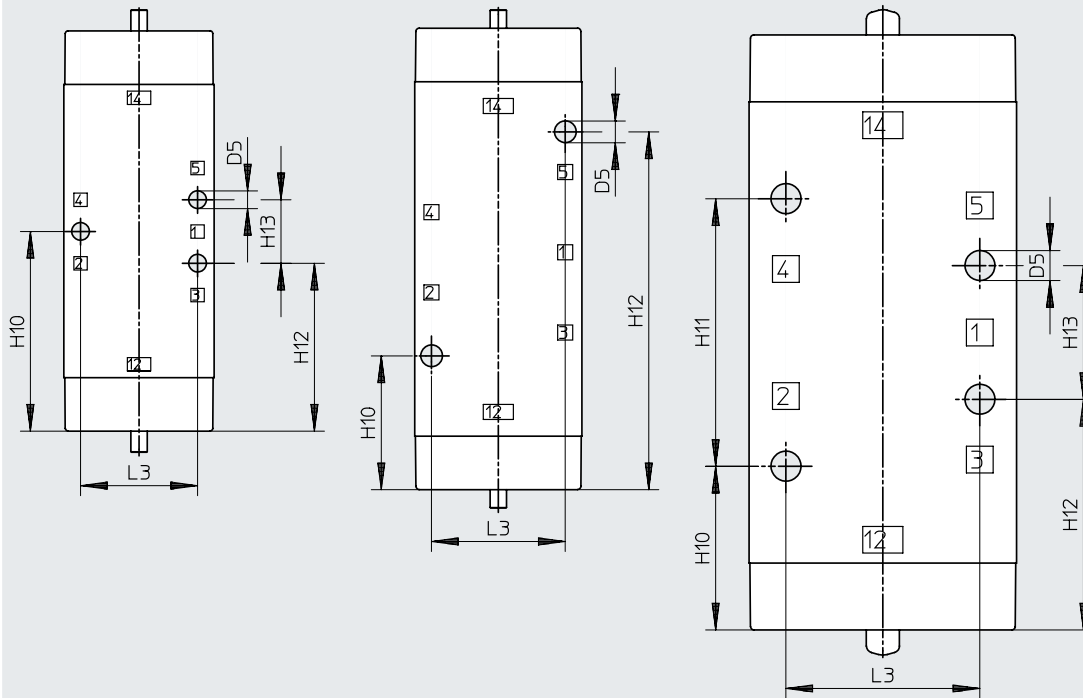

Type	D5 ∅	H10	H11	H12	H13	L3
J...-5-1/8	5.3	60	-	50.5	19	35
J...-5-1/4	6.5	40	-	107	-	40 ±0.2
J...-5-1/2	9.6 +0.2	49	80 ±0.15	69	40 ±0.1	58 ±0.15

Datasheet – 5/2-way valves, double pilot valves

Ordering data					
Circuit symbol	Description	Pneumatic connection	ATEX category	Part no.	Type
		G1/8	–	8823	JH-5-1/8
			ATEX category → Page 31	536035	JH-5-1/8-EX
		G1/4	–	10408	JH-5-1/4
			ATEX category → Page 31	536036	JH-5-1/4-EX
		G1/2	–	10165	JH-5-1/2
			ATEX category → Page 31	536037	JH-5-1/2-EX
	With dominant signal at 14	G1/8	–	8824	JDH-5-1/8
			ATEX category → Page 31	536038	JDH-5-1/8-EX
		G1/4	–	10409	JDH-5-1/4
			ATEX category → Page 31	536039	JDH-5-1/4-EX
Ordering data – Sets of wearing parts					
Pneumatic connection				Part no.	Type
G1/8				104891	JH-5-1/8¹⁾
G1/4				104892	JH-5-1/4²⁾

1) Order assembly sleeve part no. 228389 separately

2) Order assembly sleeve part no. 229363 separately

Accessories

Manifold rail PAL

Materials:

Rail: Anodised aluminium

Mounting bracket: Galvanised steel

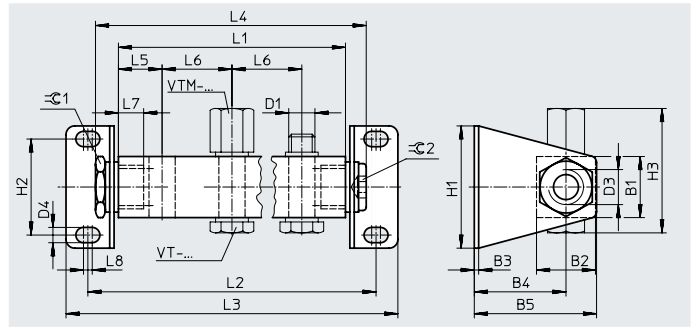
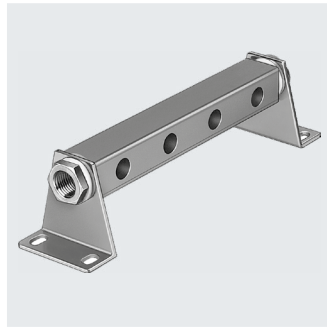

Type	B1	B2	B3	B4	B5	D1	D3	D4	H1	H2	H3	L5	L6	L7	L8	Ø1	Ø2
PAL-1/8-...	20	21	2	33.5	44.5	G1/8	G1/4	5.2	44	32	43	18	34	12	4	19	8
PAL-1/4-...	28	27	2	42	56	G1/4	G3/8	7	56	44	56	20	32	14	4	24	10
PAL-1/2-...	40	40	3	73	93	G1/2	G3/4	11	80	60	75	35	69	16	5	36	17

No. of valve ports	L1	L2	L3	L4	Weight [g]	Part no.	Type
Pneumatic connection G1/8							
2	70	96	114	89	145	8601	PAL-1/8-2
3	104	130	148	123	170	8602	PAL-1/8-3
4	138	164	182	157	190	8603	PAL-1/8-4
5	172	198	216	191	215	8604	PAL-1/8-5
6	206	232	250	225	240	9767	PAL-1/8-6
Pneumatic connection G1/4¹⁾							
2	72	100	120	94	330	9188	PAL-5-1/4-2
3	104	132	152	126	405	9189	PAL-5-1/4-3
4	136	164	184	158	480	9190	PAL-5-1/4-4
5	168	196	216	190	555	9191	PAL-5-1/4-5
6	200	228	248	222	630	9192	PAL-5-1/4-6
Pneumatic connection G1/2							
2	139	181	213	164	770	9492	PAL-1/2-2
3	208	250	282	233	915	9493	PAL-1/2-3
4	277	319	351	302	1 060	9494	PAL-1/2-4
5	346	388	420	371	1 220	9495	PAL-1/2-5
6	415	457	489	440	1 370	9496	PAL-1/2-6

1) MOFH-3-1/4 is not suitable for manifold assembly

Accessories

Hollow bolt VT

For manifold rail PAL

Note on materials:
RoHS-compliant



Ordering data				
Pneumatic connection	Weight [g]	Material	Part no.	Type
G1/8	6	Steel, chromed	8626	VT-1/8
G1/8	15	Anodised aluminium	5928	VT-1/8-1¹⁾²⁾
G1/4	15	Steel, chromed	206147	VT-1/4-2
G1/2	30	Anodised aluminium	9986	VT-1/2

- 1) For valves with G1/8 connection
2) Sealing rings included in the scope of delivery

Cap nut VTM

For blanking vacant positions

Material:
Wrought aluminium alloy



Ordering data				
Pneumatic connection	Weight [g]	Part no.	Type	
G1/8	5	9768	VTM-1/8¹⁾	
G1/4	7	3099	VTM-1/4	
G1/2	28	9987	VTM-1/2	

- 1) For valves with G1/8 connection

Accessories

Manifold block PRS

Material:
Anodised aluminium

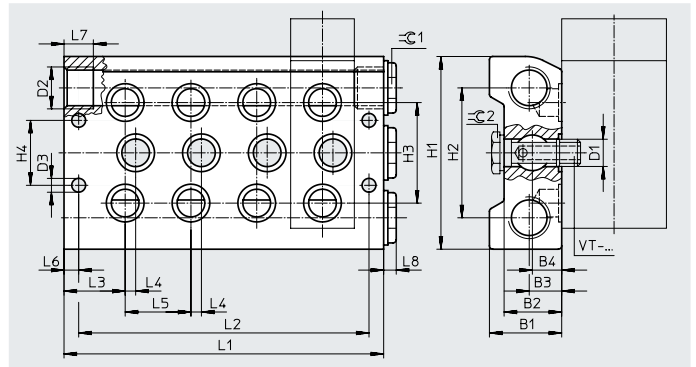

Type	B1	B2	B3	B4	D1	D2	D3	H1	H2	H3	H4	L3	L4	L5	L6	L7	L8	$\varnothing 1$	$\varnothing 2$
PRS-1/8-...	28.5	22	12.5	10.8	G1/8	G3/8	6.6	80	56	38	28	23.5	7	27	7	12	5	8	14
PRS-1/4-...	34.5	27.5	14	14	G1/4	G1/2	6.6	92	62	48	31	29.2	5	31.4	7	14	6	10	17

No. of valve ports	L1	L2	Weight [g]	Part no.	Type
Pneumatic connection G1/8					
2	81	67	360	11898	PRS-1/8-2-B
3	108	94	460	11899	PRS-1/8-3-B
4	135	121	625	11900	PRS-1/8-4-B
5	162	148	650	11901	PRS-1/8-5-B
6	189	175	750	11902	PRS-1/8-6-B
Pneumatic connection G1/4					
2	89.8	75.8	590	10185	PRS-1/4-2
3	121.2	107.2	750	10186	PRS-1/4-3
4	152.6	138.6	900	10187	PRS-1/4-4
5	184	170	1070	10188	PRS-1/4-5
6	215.4	201.4	1 230	10189	PRS-1/4-6

Hollow bolt VT

For manifold block PRS

Material:
Steel, chromed



Ordering data			
Pneumatic connection	Weight [g]	Part no.	Type
G1/8	17	11539	VT-1/8-PRSK
G1/4	32	9499	VT-1/4-PRS

Accessories

Cover plate PRSB

For blanking vacant positions

Material:
Aluminium



Ordering data			
Pneumatic connection	Weight [g]	Part no.	Type
G1/8	55	11687	PRSB-1/8
G1/4	80	11688	PRSB-1/4

Hollow bolt VT

For separate compressed air supply on valve



Material:
Steel, chromed



Ordering data			
Pneumatic connection	Weight [g]	Part no.	Type
G1/8	16	12634	VT-1/8-AJK-P
G1/4	24	12910	VT-1/8-AJS-P ¹⁾
G1/4	45	12635	VT-1/4-AJ-P

1) For valves with G1/8 connection

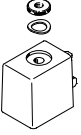
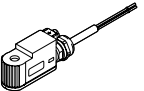
Accessories

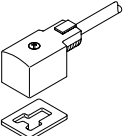
Ordering data – Solenoid coils						
	Description	Voltage	Cable length [m]	Part no.	Type	
F solenoid coils, without plug socket				Datasheets → Internet: msfg		
	–	12 V DC	–	34410	MSFG-12-OD	
		24 V DC and 42 V AC, 50 ... 60 Hz	–	34411	MSFG-24/42-50/60-OD	
		42 V DC	–	34413	MSFG-42-OD	
		24 V AC	–	34415	MSFW-24-5 0/60-OD	
		48 V AC, 50 ... 60 Hz	–	34418	MSFW-48-5 0/60-OD	
		110 V AC, 50 ... 60 Hz and 120 V AC, 60 Hz	–	34420	MSFW-110-5 0/60-OD	
		230 V AC, 50 ... 60 Hz and 240 V AC, 60 Hz	–	34422	MSFW-230-5 0/60-OD	
		240 V AC, 50 ... 60 Hz	–	34424	MSFW-240-5 0/60-OD	
	Explosion-proof	24 V DC	–	536931	MSFG-24-EX	
		24 V AC	–	536932	MSFW-24-5 0/60-EX	
		110 V AC	–	536933	MSFW-110-5 0/60-EX	
		230 V AC	–	536934	MSFW-230-5 0/60-EX	
F solenoid coils, cable with open end, 3-core						
	Explosion-proof	24 V DC	1	8059804	VACF-B-K1-1-1-EX4-M	
			5	8059805	VACF-B-K1-1-5-EX4-M	
			10	8059806	VACF-B-K1-1-10-EX4-M	
			20	8059807	VACF-B-K1-1-20-EX4-M	
		24 V AC	1	8059808	VACF-B-K1-1A-1-EX4-M	
			5	8059811	VACF-B-K1-16B-1-EX4-M	
		110 V AC	1	8059811	VACF-B-K1-16B-1-EX4-M	
			5	8059812	VACF-B-K1-16B-5-EX4-M	
			230 V AC	1	8059809	VACF-B-K1-3A-1-EX4-M
				5	8059810	VACF-B-K1-3A-5-EX4-M
Ordering data – Plug sockets/connecting cable for F solenoid coils						
	Description	Voltage	Cable length [m]	Part no.	Type	
Plug socket without cable, cable connection with				Datasheets → Internet: mssd		
	Locking screws (cable connector Pg9)	–	–	34431	MSSD-F	
	Locking screws (cable connector M16)	–	–	539710	MSSD-F-M16	
Connecting cable				Datasheets → Internet: kmf		
	Signal status indication with LED	24 V DC	2.5	30935	KMF-1-24DC-2.5-LED	
			5	30937	KMF-1-24DC-5-LED	
			10	193458	KMF-1-24DC-10-LED	
	Without signal status indication	Up to 240 V	2.5	30936	KMF-1-230AC-2.5	
			5	30938	KMF-1-230AC-5	

Accessories

Ordering data – Illuminating seal				Datasheets → Internet: mf-ld	
	Description	Voltage	Part no.	Type	
	For F solenoid coils	12 ... 24 V DC 230 V DC/V AC	19143	MF-LD-12-24DC	
			19144	MF-LD-230AC	

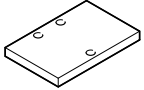
Ordering data – Plate					
	Description		Pneumatic connection	Part no.	Type
For wide solenoid coils					
	As spacer when using wider solenoid coils from other manufacturers (thickness: 6.35 mm)	For 3/2-way valves	G1/8	541667	MPL-TC-3-18
			G1/4	541669	MPL-TC-3-14
		For 5/2-way valves	G1/8	541668	MPL-TC-5-18
			G1/4	541670	MPL-TC-5-14