

Proximity switch SMT0-1

FESTO



Type code

001	Series	
SMT0-1	Proximity switch, block design, magneto-resistive	
002	Switching output, switching element function	
PS	PNP, N/O contact, 3-wire	
NS	NPN, N/O contact, 3-wire	
003	Electrical connection, cable length	
K	Cable, 2.5 m	
S	Plug M8x1	

004	Switching status indication	
LED	Yellow LED	
005	Rated operating voltage	
24	24 V DC	
006	Generation	
C	Series C	

Datasheet

General technical data

Design	Block design
Mounting position	optional
Based on standard	EN 60947-5-2
Approval	RCM trademark
CE mark (see declaration of conformity)	To EU EMC Directive, In accordance with EU RoHS Directive
CE marking (see declaration of conformity)	To UK RoHS instructions, To UK instructions for EMC
Note on materials	RoHS-compliant
LABS (PWIS) conformity	VDMA24364-B2-L

Input signal/measuring element

Measured variable	Position
Measuring principle	Magneto-inductive
Ambient temperature	-25 ... 70 C
Ambient temperature with moving cable	-5 ... 70 C

Switching output

Switching output	NPN, PNP
Switching element function	N/O contact
Hysteresis	0.1 ... 1.5 mm
Repetition accuracy	0.2 mm
Switch-on time	≤1 ms
Switch-off time	≤1 ms
Max. switching frequency	1 kHz
Max. output current	200 mA
Max. switching capacity DC	6 W
Voltage drop	≤3 V
Inductive protective circuit	Adapted to MZ, MY, ME coils

Output, further data

Short circuit current rating	Pulsed
Overload protection	Available

Electronics

Operational voltage range DC	10 ... 30 V
Residual ripple	10%
Reverse polarity protection	For all electrical connections

Electromechanics

Electrical connection 1, connection type	Cable	Plugs
Electrical connection 1, function	Power supply, Switching output	
Electrical connection 1, connector system	Open end	M8x1, A-coded, to EN 61076-2-104
Electrical connection 1, number of connections/cores	3	
Electrical connection 1, used connections/cores	3	
Connection outlet orientation	In-line	
Cable length	2.5 m	–
Cable characteristic	Standard	–
Cable sheath colour	grey	–
Material cable sheath	PVC	–
Material insulating sheath	PVC	–
Wire ends	Wire end sleeve	–

Datasheet

Display/operation

Switching status indication	Yellow LED
-----------------------------	------------

Mechanics

Electrical connection 1, connection type	Cable	Plugs
Type of mounting	With accessories	
Product weight	85 g	20 g
Material housing	PET, Die-cast zinc	PC, PET, POM, PUR, Steel, Die-cast zinc
Housing colour	Black	

Immission/emission

Degree of protection	IP67
Corrosion resistance class CRC	1 - Low corrosion stress

Dimensions

Dimensions – SMTO-1 – cable

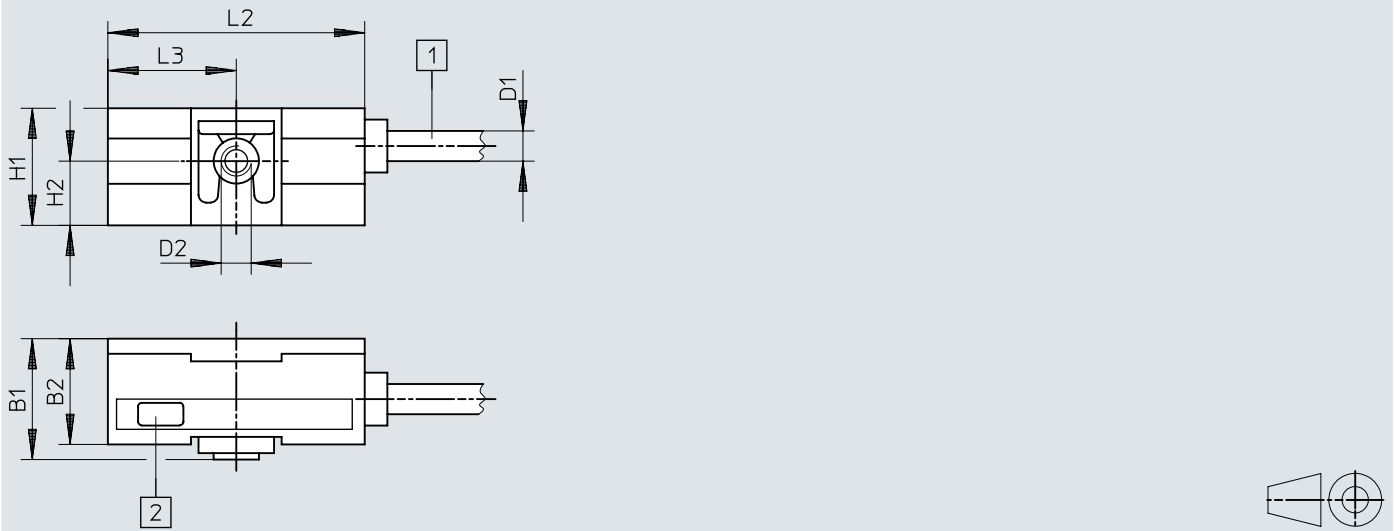
Download CAD data → www.festo.com

- [1] Connecting cable
 [2] Yellow light emitting diode

	B1	B2	D1 ∅	D2	H1	H2	L2	L3
	-0,2	±0,3	-0,3		±0,2	±0,1	±0,2	-0,1
SMTO-1- ... SK-LED-24-C	16	14	4	M4	15,5	8,5	34	17

Dimensions

Dimensions – SMT0-1-S - plug M8x1

Download CAD data → www.festo.com

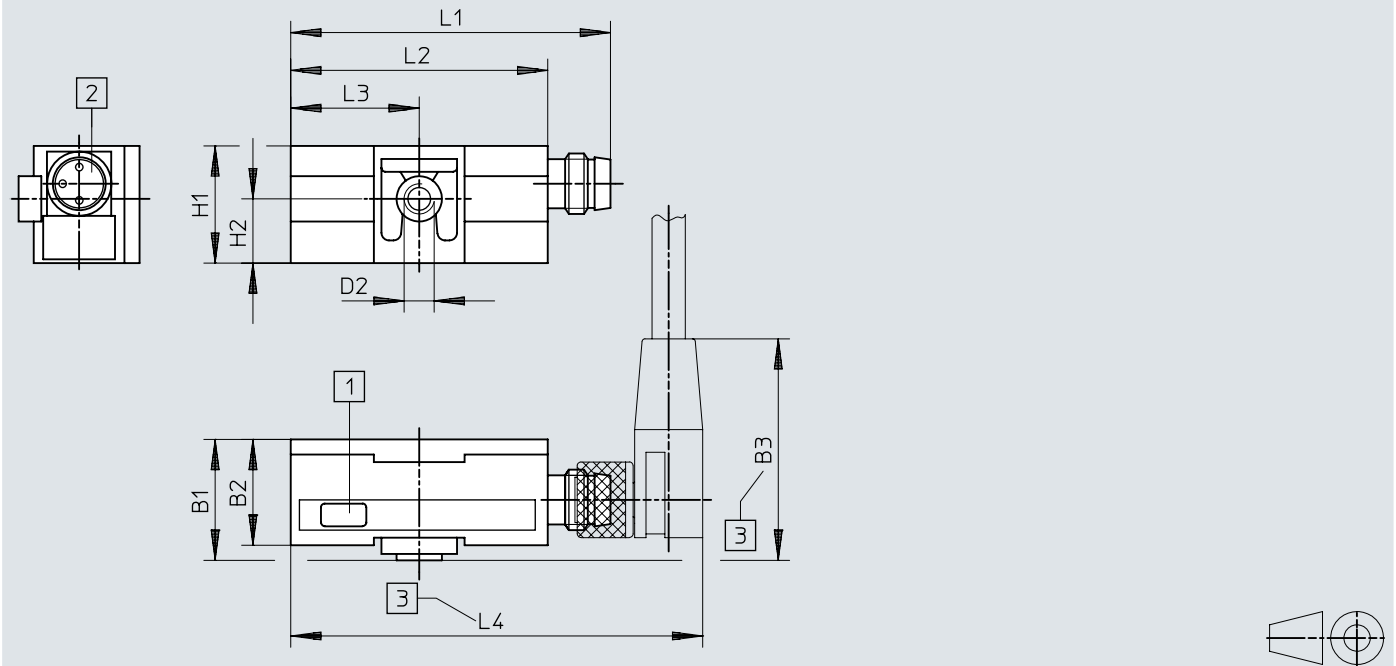

- [1] Yellow light emitting diode
- [2] Suitable for plug socket type SIM-M8
- [3] Installation space for plug socket with 90° corner bracket

	B1	B2	B3	D2	H1	H2	L1	L2	L3	L4
	-0,2	±0,3			±0,2	±0,1	±0,3	±0,2	-0,1	
SMT0-1...S-S-LED-24-C	16	14	~27,5	M4	15,5	8,5	42,3	34	17	~54,5

Dimensions

Dimensions – Mounting kit SMB-1

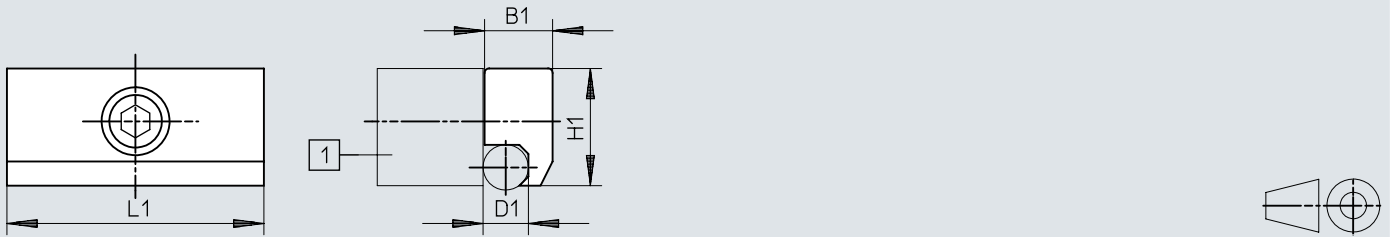
Download CAD data → www.festo.com

[1] Proximity switch SME0, SMT0, SMPO-1

		B1	D1 ∅	H1	L1
SMB-1	32 ... 100	9	6	15,5	34

Dimensions

Dimensions – Mounting kit SMB-2-B/SMB-3-B

Download CAD data → www.festo.com

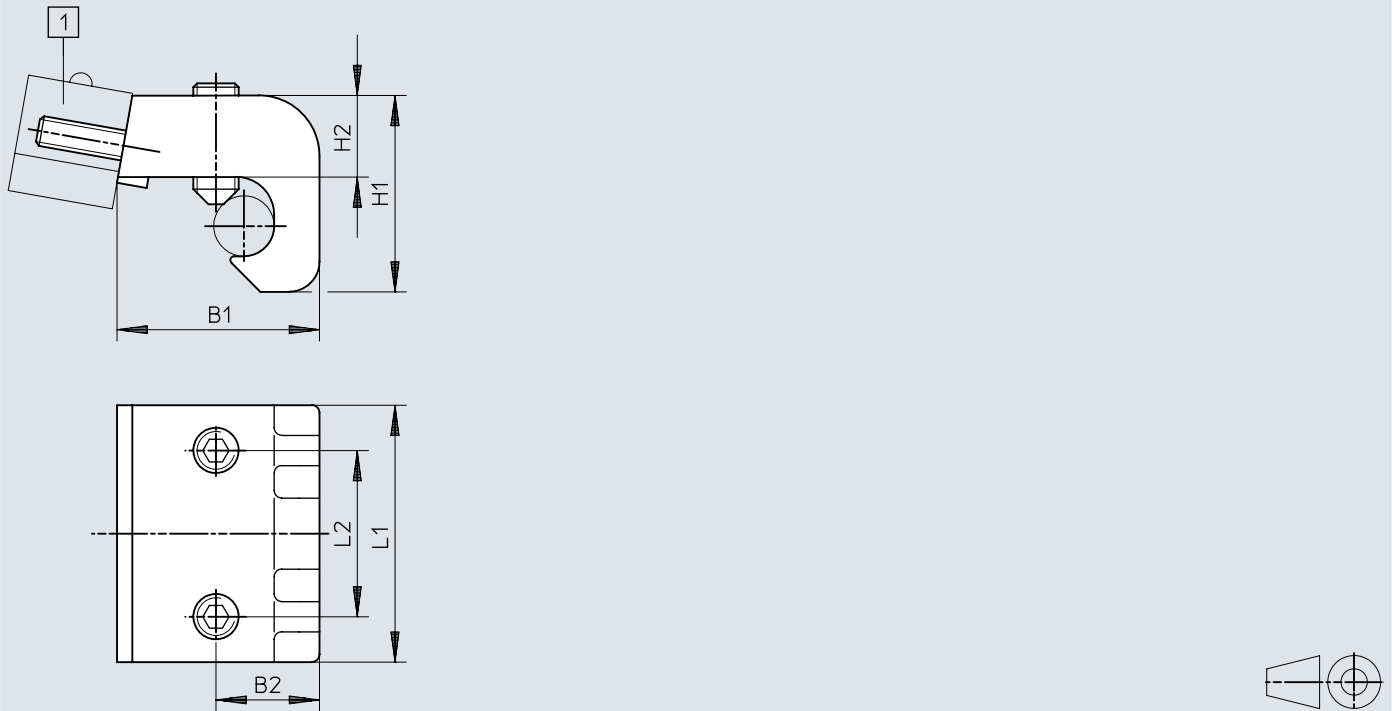

[1] Proximity switch SME0, SMT0, SMP0-1

		B1	B2	H1	H2	L1	L2
SMB-2-B	32 ... 50	18	11	23	11,6	34	22
SMB-3-B	63 ... 100	26,8	13,7	26	10,8	34	22

Dimensions

Dimensions – Mounting kit SMBU

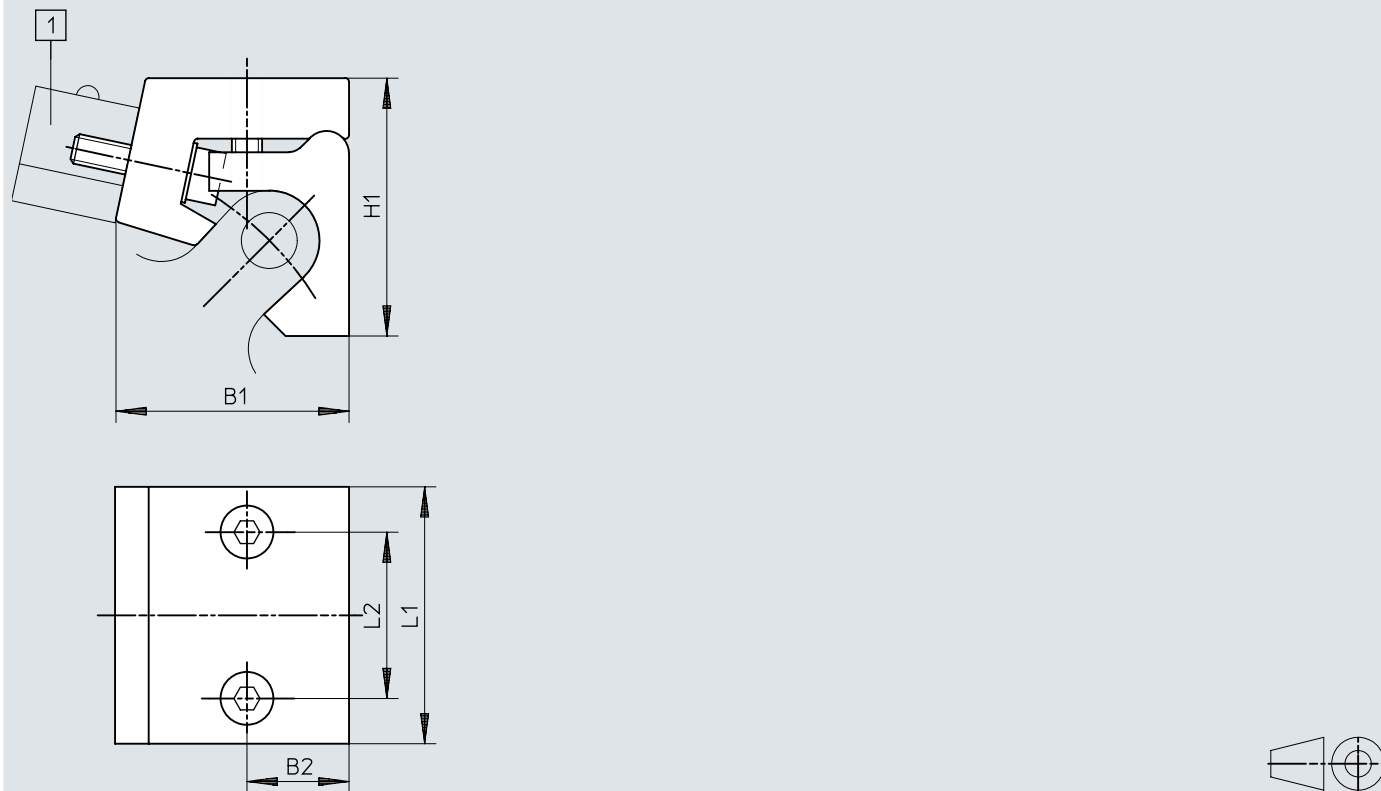
Download CAD data → www.festo.com

[1] Proximity switch SMEO, SMT0, SMPO-1

		B1	B2	H1	L1	L2
SMBU-1-B ¹⁾	32 ... 50	19	8,5	30	34	22
SMBU-2-B ¹⁾	63 ... 100	31	13,5	34	34	22
SMBU-3-B	125	31	13,5	37	34	22

1) Free of copper and PTFE

Ordering data

Ordering data						
	Electrical connection 1, connection type	Electrical connection 1, number of connections/cores	Switching output	Cable length	Part no.	Type
	Cable	3	NPN	2.5 m	151684	SMT0-1-NS-K-LED-24-C
	Plugs		PNP			151683
			NPN		151686	SMT0-1-NS-S-LED-24-C
			PNP		151685	SMT0-1-PS-S-LED-24-C

Peripherals

Peripherals overview

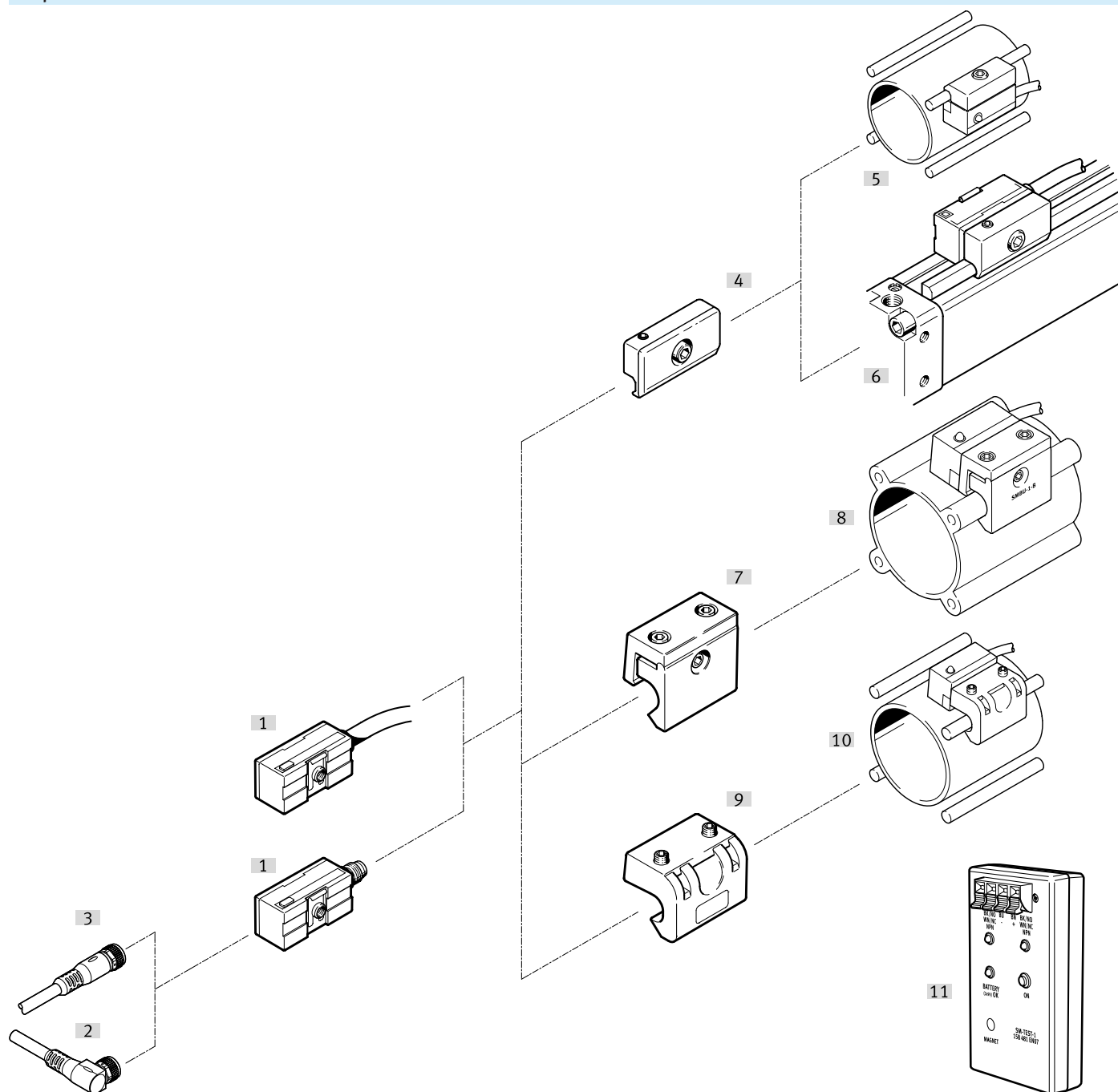

Accessories			→ Page/Internet
Type/order code	Description		
[1] Proximity switch, SMT0-1, magneto-resistive, with cable	Magneto-resistive, with cable		smt0-1
[1] Proximity switch SMT0-1, magneto-resistive, with 1xM8 plug	Magneto-resistive, with 1xM8 plug		smt0-1
[2] Connecting cable NEBU, socket, M8x1, 3-pin, angled	Angled socket, M8x1, 3-pin		13
[3] Connecting cable NEBU, socket M8x1, 3-pin, straight	Straight socket, M8x1, 3-pin		13
[4] Mounting kit SMB-1	<ul style="list-style-type: none"> • For drives with \varnothing 6 mm tie rod or mounting strip • For standards-based cylinder DSBG 		13
[5] Standards-based cylinder DSBG	\varnothing 32 ... 125 mm		-
[6] Flat cylinder DZH	\varnothing 32 ... 63 mm		-
[7] Mounting kit SMBU	For standards-based cylinder DNU		13

Peripherals

Accessories		→ Page/Internet
Type/order code	Description	
[8] Standards-based cylinder DSBG	Ø 32 ... 125 mm	–
[9] Mounting kit SMB-2-B, SMB-3-B	For standards-based cylinder DSB	13
[10] Standards-based cylinder DNU	Ø 32 ... 125 mm	–
[11] Sensor tester SM-TEST-1	Checking that the proximity switches are functioning using the built-in voltage source. Adjustment of proximity switches on the cylinder	13

Accessories

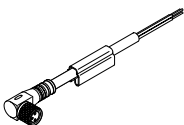
Connecting cable NEBU, socket M8x1, 3-pin, angled						
	Connection technology left, field device side	Electrical connection 1, cable outlet	Connection technology right, controller side	Cable length [m]	Part no.	Type
	Socket M8x1 A-coded, EN 61076-2-104	Angled	Open end	2.5 m	★ 541338	NEBU-M8W3-K-2.5-LE3
				5 m	★ 541341	NEBU-M8W3-K-5-LE3

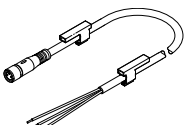
Connecting cable NEBU, socket M8x1, 3-pin, straight						
	Connection technology left, field device side	Electrical connection 1, cable outlet	Connection technology right, controller side	Cable length [m]	Part no.	Type
	Socket M8x1 A-coded, EN 61076-2-104	Straight	Open end	2.5 m	★ 541333	NEBU-M8G3-K-2.5-LE3
				5 m	★ 541334	NEBU-M8G3-K-5-LE3

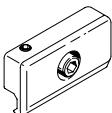
Mounting kit SMB-1				
	Size	RoHS status	Part no.	Type
	1	RoHS-compliant in accordance with EU directive	11886	SMB-1

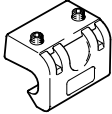
Mounting kit SMB-2-B, SMB-3-B				
	Size	RoHS status	Part no.	Type
	2	RoHS-compliant in accordance with EU directive	36162	SMB-2-B
	3		36163	SMB-3-B

Mounting kit SMBU				
	Size	RoHS status	Part no.	Type
	1	RoHS-compliant in accordance with EU directive	36173	SMBU-1-B
	2		36174	SMBU-2-B
	3		152828	SMBU-3-B

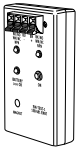
Sensor tester SM-Test-1					
	Operational voltage range DC	Ambient temperature	Degree of protection	Part no.	Type
	12 ... 20 V	0 ... 40 °C	IP20	158481	SM-TEST-1