

Vacuum suction grippers ESG

FESTO

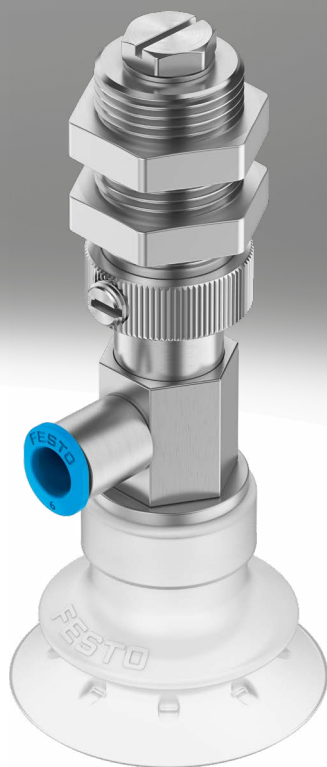

Key features

Product overview

Suction grippers from Festo offer outstanding functionality and quality.

An extensive, modular range of suction cups with connection attachments, in different shapes, materials and sizes, plus a selec-

tion of suction cup holders, angle and height compensators and vacuum filters within the modular suction gripper system, provide

users with a huge choice of possible combinations for a wide variety of applications.

Vacuum suction grippers ESG

→ Page 7

Modular products with over 2000 variants

- The ideal solution for transporting workpieces with a wide range of weights, surfaces and shapes
- Choose from:
 - 15 suction cup diameters
 - 6 different materials – including antistatic ones
 - 6 suction cup shapes
 - Numerous suction cup holders
 - Optional accessories (vacuum filters and angle compensators)
- Wide range of variants
- A suitable solution for every task
- Wide range to suit applications with various temperature ranges and workpiece surfaces
- Suction cups made from silicone are approved for use in the food industry

Suction gripper as a complete solution

Suction gripper made of individual components

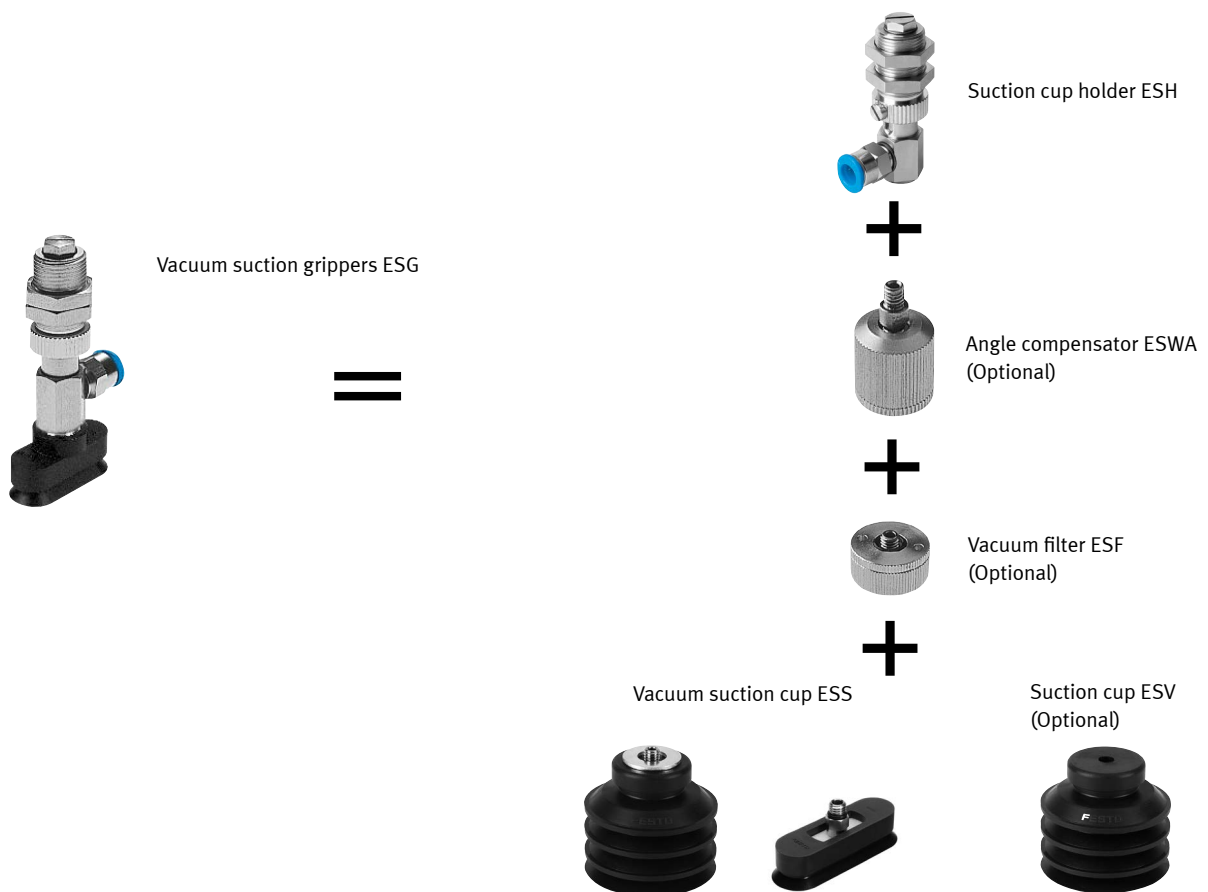

Key features

Suction cups with connector

Datasheets → Internet: vas

VAS/VASB

Sturdy and reliable

- The ideal solution for transporting workpieces with a wide range of weights, surfaces and shapes
- Choose from:
 - 12 suction cup diameters
 - 2 suction cup shapes: round and bellows design with 1.5 convolutions
 - 3 materials: nitrile rubber, polyurethane and silicone for use in a wide variety of applications
- Wide range to suit applications with various temperature ranges and workpiece surfaces
- Suction cups made from silicone are approved for use in the food industry
- All tubing connection sizes correspond to a holder size



Key features

At a glance

The Festo suction gripper range offers a wide variety of possible combinations with a modular product system comprising more than 2000 variants.

Choose from:

- 2 suction cup shapes:
 - Round, 15 different diameters
 - Oval, 11 different diameters
- 6 suction cup designs
- 6 different suction cup materials

- Numerous suction cup holders:
 - With and without height compensators
 - With various tubing connections: push-in connector, barbed connector, thread
- Optional accessories: vacuum filters, angle compensators and suction cup inserts

Even extremely small workpieces, e.g. in the electronics industry, can be conveyed gently and accurately.

All parts of the modular range can also be replaced quickly and easily if requirements change.

Suction grippers can be ordered complete, or as individual components.

Cost savings thanks to:

- Modular range
- The low-cost suction cup can be easily replaced (wearing part)
- Reduced warehousing
- Long service life
- Low investment costs
- Large range – including industry-specific solutions

The complete solution

The suction gripper ESG comes already assembled to meet your specific requirements and is ready to use.

The suction cup shape and dimensions together form a part number which you can customise to form a type code by adding your own choice of suction cup material, holder type, tubing connection and accessories.

The benefit to you:

With just one part number and type code you can order your own complete suction gripper.



The individual components

If, for instance, you have to handle a different workpiece surface finish, all you need to do is add the right suction cup.

The benefit to you: By adding individual components you can create new areas of application for your suction gripper ESG.

Suction cup holder ESH

[Datasheets](#) → [Internet: esh](#)

The area of application determines which is the right suction cup holder to use.

The suction cup or accessory is attached directly to the suction cup holder.

- 6 holder sizes
- 8 holder types
- 3 tubing connector options



Vacuum suction cup ESS

[Datasheets](#) → [Internet: ess](#)

The suction cup consists of the suction cup itself, plus the support plate with mounting.

Here too, the area of application of the suction gripper determines which is the right suction cup to use.

- 6 connection sizes: a tubing connection for every holder size
- 2 suction cup shapes
- 6 suction cup designs
- 6 suction cup materials



Accessories

Vacuum filter ESF

[Datasheets](#) → [Internet: esf](#)

- For protecting vacuum generators from contamination or damage



Angle compensator ESWA

[Datasheets](#) → [Internet: eswa](#)

- The angle compensator ensures maximum suction cup grip for materials with uneven surfaces.



Suction-cup insert OASI

[Datasheets](#) → [Internet: oasi](#)

- For conveying unstable and fragile workpieces



Product range overview

Suction cup holder

Threaded connection G
 For suction cup @ 60 ... 200 mm
 For suction cup size 15x45 ... 30x90 mm

Push-in connector QS
 For suction cup @ 2 ... 50 mm
 For suction cup size 4x10 ... 10x30 mm

Barbed connector PK
 For suction cup @ 2 ... 50 mm
 For suction cup size 4x10 ... 10x30 mm

Holder type
 For suction cup @ [mm]
 For suction cup size [mm]

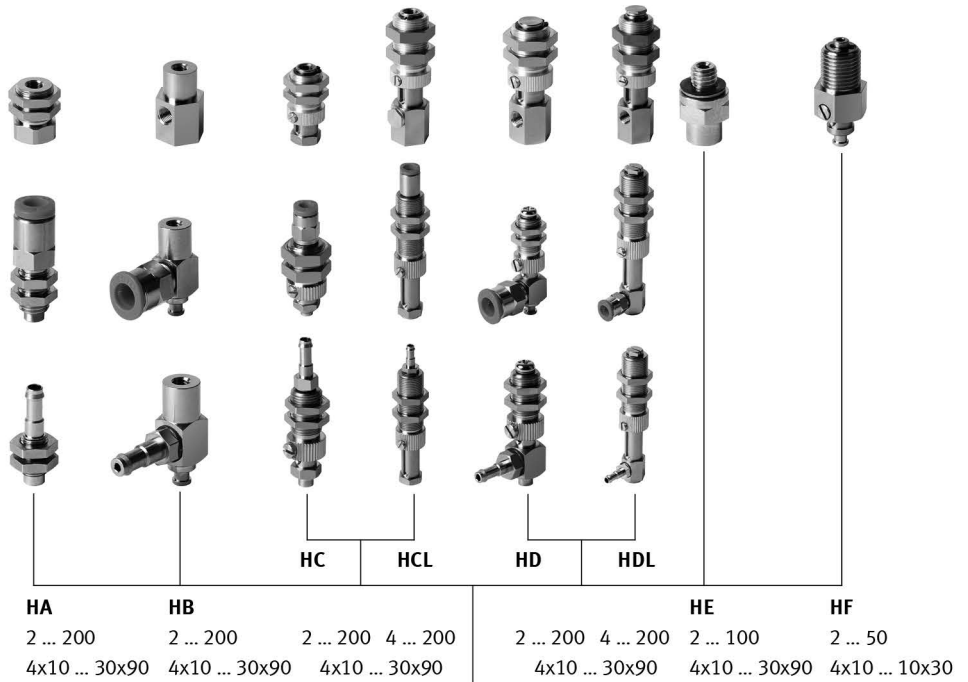

Angle compensation
 For suction cup @ 10 ... 100 mm
 Only holder sizes 3, 4 and 5

Vacuum filter
 For suction cup @ 10 ... 50 mm
 For suction cup size 4x10 ... 30x90 mm
 Only holder sizes 3 and 4

Suction cup with connector

- Materials:
- FPM (fluoro rubber)
 for suction cup @ 2 ... 200 mm
 - NBR (nitrile rubber)
 for suction cup @ 2 ... 200 mm
 - BR (butadiene rubber) antistatic
 for suction cup @ 2 ... 50 mm
 - VMQ (silicone)
 for suction cup @ 2 ... 200 mm
 - PUR (polyurethane)
 for suction cup @ 2 ... 200 mm
 - Vulkollan®
 for suction cup @ 30 ... 100 mm

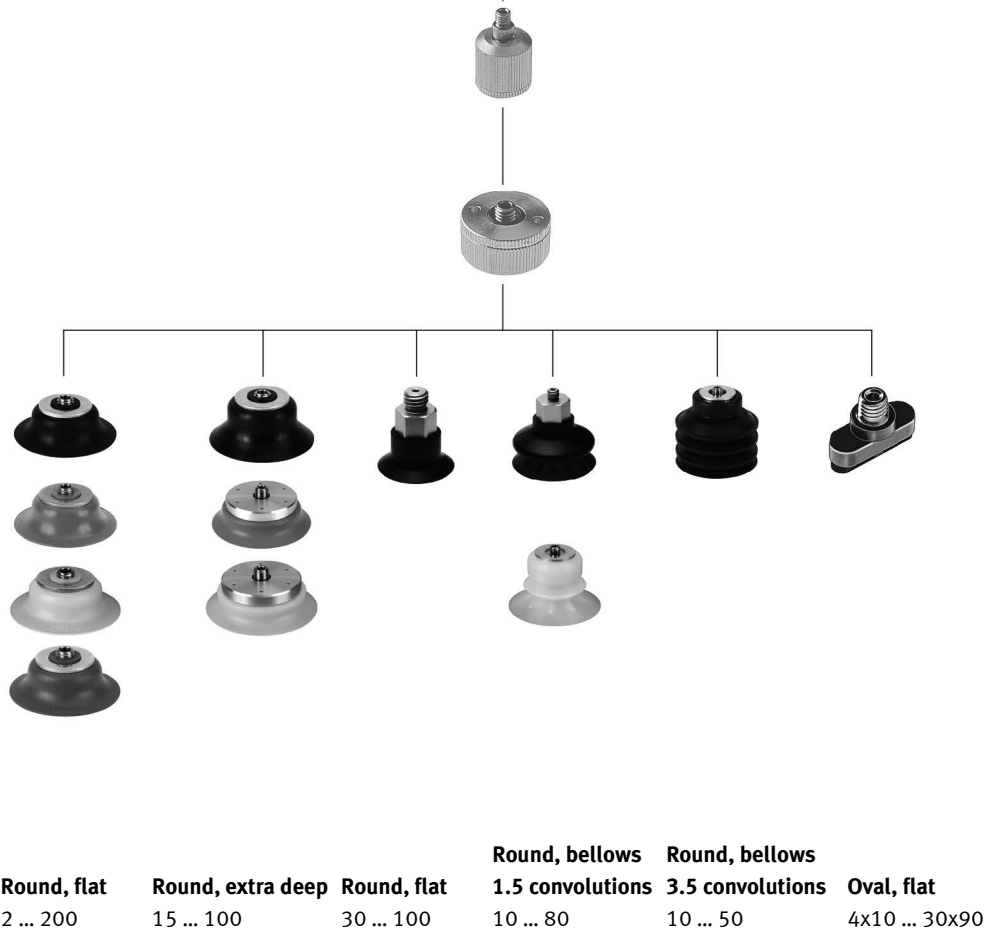

® Registered trademark of the Bayer MaterialScience AG Group

Type codes

ESG, round design

001	Series	
ESG	Suction gripper	

002	Suction cup size	
2	2 mm diameter	
4	4 mm diameter	
6	6 mm diameter	
8	8 mm diameter	
10	10 mm diameter	
15	15 mm diameter	
20	20 mm diameter	
30	30 mm diameter	
40	40 mm diameter	
50	50 mm diameter	
60	60 mm diameter	
80	80 mm diameter	
100	100 mm diameter	
150	150 mm diameter	
200	200 mm diameter	

003	Standard suction cup	
	None	
SF	FPM (fluoro rubber)	
SN	NBR (nitrile rubber)	
SS	VMQ (silicone)	
SU	PUR (polyurethane)	
SNA	BR (butadiene rubber), anti-static	

004	Suction cup with connector extra deep	
	None	
EF	FPM (fluoro rubber)	
EN	NBR (nitrile rubber)	
ES	VMQ (silicone)	
EU	PUR (polyurethane)	

005	Bellows, 1.5 convolutions	
	None	
BN	NBR (nitrile rubber)	
BS	VMQ (silicone)	
BT	Vulkollan®	
BU	PUR (polyurethane)	

006	Bellows, 3.5 convolutions	
	None	
CN	NBR (nitrile rubber)	
CS	VMQ (silicone)	

007	Suction cup with connector, deep	
	None	
GT	Vulkollan®	

008	Suction cup holder	
HA	Male thread, 2 nuts, connection on top	
HB	Female thread, connection on side	
HC	Male thread, 2 nuts, connection on top, height compensation	
HCL	Male thread, 2 nuts, connection on top, long height compensation	
HD	Male thread, 2 nuts, connection on the side, height compensation	
HDL	Male thread, 2 nuts, connection on the side, long height compensation	
HE	Male screw-in thread, connection on top	
HF	Male screw-in thread, connection on top, height compensation	

009	Vacuum connection	
	None	
G	Threaded connection	
PK	Barbed fitting connection	
QS	Push-in connector	

010	Angle compensator	
	None	
WA	Ball joint with 30° deflection	

011	Filters	
	None	
F	Filters	

012	Suction cup insert	
	None	
ES	Sinter	

Type codes

ESG, oval design

001	Series
ESG	Suction gripper

002	Suction cup size
4x10	4x10 mm
4x20	4x20 mm
6x10	6x10 mm
6x20	6x20 mm
8x20	8x20 mm
8x30	8x30 mm
10x30	10x30 mm
15x45	15x45 mm
20x60	20x60 mm
25x75	25x75 mm
30x90	30x90 mm

003	Suction cup, oval
ON	NBR (nitrile rubber)

004	Suction cup holder
HA	Male thread, 2 nuts, connection on top
HB	Female thread, connection on side
HC	Male thread, 2 nuts, connection on top, height compensation
HCL	Male thread, 2 nuts, connection on top, long height compensation
HD	Male thread, 2 nuts, connection on the side, height compensation
HDL	Male thread, 2 nuts, connection on the side, long height compensation
HE	Male screw-in thread, connection on top
HF	Male screw-in thread, connection on top, height compensation

005	Vacuum connection
	None
G	Threaded connection
PK	Barbed fitting connection
QS	Push-in connector

006	Filters
	None
F	Filters

Datasheet – Holder size 1

Holder size 1

For suction cup \varnothing 2/4 mm

Suction cup shape:

- Round, flat



General technical data – Suction cup S

Datasheets → Internet: [ess](#)

Suction cup shape		Suction cup \varnothing [mm]	
		2	4
S – round, flat: material FPM, NBR, BR, VMQ (silicone), PUR			
	Connection suction cup holder	O.D. 3 mm ¹⁾	O.D. 3 mm ¹⁾
	Nominal width [mm]	0.6	1.2
	Holding force at nominal operating pressure –0.7 bar [N]	0.1	0.46
	Suction cup volume [cm ³]	0.002	0.008
	Min. workpiece radius [mm]	10	10
	Weight [g]	0.1	0.1

1) Is inserted into the suction cup holder.

Material types – Suction cup S

Material	F	N	NA	S	U
Shore hardness	60 ±5	50 ±5	50 ±5	50 ±5	60 ±5
Suction cup	FPM	NBR	BR	VMQ (silicone)	PUR
	Colour: grey	Colour: black	Colour: black/white dot	Colour: transparent	Colour: blue
Screwed plug	Nickel-plated brass				
Note on materials	RoHS-compliant				

Operating and environmental conditions – Suction cup S

Material	F	N	NA	S	U
Operating medium	Atmospheric air based on ISO 85731:2010 [7:–:–]				
Ambient temperature [°C]	–10 ... +200	–10 ... +70	–10 ... +70	–30 ... +180	–20 ... +60
Corrosion resistance class CRC ¹⁾	1 - Low corrosion stress				
Special characteristics	–	–	Antistatic	–	–
Food-safe	–	–	–	As per manufacturer's declaration	–

1) More information: www.festo.com/x/topic/crc

Datasheet – Holder size 1

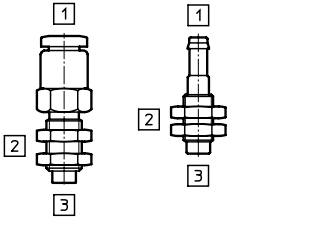
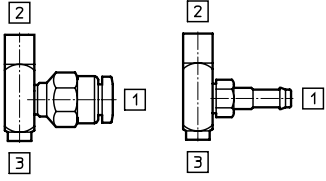
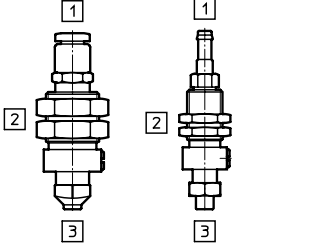
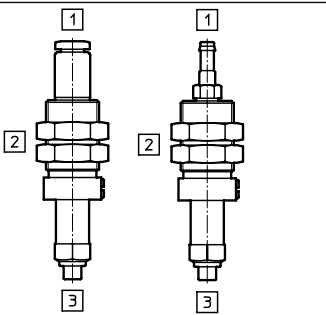
General technical data – Suction cup holder HA/HB/HC/HCL		Datasheets → Internet: esh	
Vacuum port [1]		QS-4	PK-3
HA – Vacuum port on top, mounting with lock nut, without height compensator			
	Mounting thread [2]	M6x0.75	M5x0.5
	Suction cup mounting [3]	\varnothing 3 mm	\varnothing 3 mm
	Nominal width [mm]	3	2.5
	Volume [cm ³]	0.239	0.09
	Ambient temperature [°C]	0 ... +60	-10 ... +60
	Weight [g]	6	3
	Materials of holder	Tempered steel, high-alloy steel, POM	Tempered steel, high-alloy steel
	Seal materials	NBR	NBR, steel
	Note on materials	RoHS-compliant	RoHS-compliant
HB – Vacuum port on the side, mounting with female thread, without height compensator			
	Mounting thread [2]	M3	M3
	Suction cup mounting [3]	\varnothing 3 mm	\varnothing 3 mm
	Nominal width [mm]	3	2.5
	Volume [cm ³]	0.228	0.108
	Ambient temperature [°C]	0 ... +60	-10 ... +60
	Weight [g]	5	4
	Materials of holder	Tempered steel, high-alloy steel, POM	Tempered steel, high-alloy steel
	Seal materials	NBR, steel	NBR, steel
	Note on materials	RoHS-compliant	RoHS-compliant
HC – Vacuum port on top, mounting with lock nut, with height compensator			
	Mounting thread [2]	M12x1	M8x0.75
	Suction cup mounting [3]	\varnothing 3 mm	\varnothing 3 mm
	Nominal width [mm]	2.4	1.2
	Volume [cm ³]	0.385	0.117
	Height compensator [mm]	3	3
	Spring force (normal/min. length) [N]	Max. 1	Max. 1
	Ambient temperature [°C]	0 ... +60	-10 ... +60
	Weight [g]	17	8
	Materials of holder	Tempered steel, high-alloy steel, POM	Tempered steel, high-alloy steel
Seal materials	NBR, steel	NBR, steel	
Note on materials	RoHS-compliant	RoHS-compliant	
HCL – Vacuum port on top, mounting with lock nut, with long height compensator			
	Mounting thread [2]	M12x1	M12x1
	Suction cup mounting [3]	\varnothing 3 mm	\varnothing 3 mm
	Nominal width [mm]	2.8	1.9
	Volume [cm ³]	0.489	0.360
	Height compensator [mm]	10	10
	Spring force (normal/min. length) [N]	Max. 1	Max. 1
	Ambient temperature [°C]	0 ... +60	-10 ... +60
	Weight [g]	20	19
	Materials of holder	Tempered steel, high-alloy steel, POM	Tempered steel, high-alloy steel
Seal materials	NBR, steel	NBR, steel	
Note on materials	RoHS-compliant	RoHS-compliant	

Datasheet – Holder size 1

General technical data – Suction cup holder HD/HDL		Datasheets → Internet: esh	
Vacuum port [1]		QS-4	PK-3
HD – Vacuum port on the side, mounting with lock nut, with height compensator			
	Mounting thread [2]	M8x0.75	M8x0.75
	Suction cup mounting [3]	$\varnothing 3$ mm	$\varnothing 3$ mm
	Nominal width [mm]	3	1.9
	Volume [cm ³]	0.241	0.120
	Height compensator [mm]	3	3
	Spring force (normal/min. length) [N]	Max. 1	Max. 1
	Ambient temperature [°C]	0 ... +60	-10 ... +60
	Weight [g]	13	11
	Materials of holder	Tempered steel, high-alloy steel, POM	Tempered steel, high-alloy steel
	Seal materials	NBR, steel	NBR, steel
Note on materials	RoHS-compliant	RoHS-compliant	
HDL – Vacuum port on the side, mounting with lock nut, with long height compensator			
	Mounting thread [2]	M12x1	M12x1
	Suction cup mounting [3]	$\varnothing 3$ mm	$\varnothing 3$ mm
	Nominal width [mm]	3	1.9
	Volume [cm ³]	0.272	0.150
	Height compensator [mm]	10	10
	Spring force (normal/min. length) [N]	Max. 1	Max. 1
	Ambient temperature [°C]	0 ... +60	-10 ... +60
	Weight [g]	29	28
	Materials of holder	Tempered steel, high-alloy steel, POM	Tempered steel, high-alloy steel
	Seal materials	NBR, steel	NBR, steel
Note on materials	RoHS-compliant	RoHS-compliant	
General technical data – Suction cup holder HE		Datasheets → Internet: esh	
Vacuum port [1]		M3	
HE – Vacuum port on top, with threaded connection for direct screw-in, without height compensator			
	Mounting thread [2]	M3	
	Suction cup mounting [3]	$\varnothing 3$ mm	
	Nominal width [mm]	1.2	
	Volume [cm ³]	0.04	
	Ambient temperature [°C]	-10 ... +60	
	Weight [g]	1	
	Materials of holder	Tempered steel	
Seal materials	NBR, steel, wrought aluminium alloy, POM		
Note on materials	RoHS-compliant		
General technical data – Suction cup holder HF		Datasheets → Internet: esh	
Vacuum port [1]		M10x1	
HF – Vacuum port on top, with threaded connection for direct screw-in, with height compensator			
	Mounting thread [2]	M10x1	
	Suction cup mounting [3]	$\varnothing 3$ mm	
	Nominal width [mm]	2	
	Volume [cm ³]	0.108	
	Height compensator [mm]	2.6	
	Spring force (normal/min. length) [N]	2/4	
	Ambient temperature [°C]	-10 ... +60	
	Weight [g]	14	
	Materials of holder	Tempered steel	
Seal materials	NBR, POM		
Note on materials	RoHS-compliant		

Datasheet – Holder size 2

Holder size 2For suction cup \varnothing 6/8 mm

Suction cup shape:

- Round, flat

**General technical data – Suction cup S**

Datasheets → Internet: ess

Suction cup shape		Suction cup \varnothing [mm]	
		6	8
S – round, flat: material FPM, NBR, BR, VMQ (silicone), PUR			
	Connection suction cup holder	I.D. 4 mm ¹⁾	I.D. 4 mm ¹⁾
	Nominal width [mm]	2	2
	Holding force at nominal operating pressure –0.7 bar [N]	1.1	2.3
	Suction cup volume [cm ³]	0.015	0.030
	Min. workpiece radius [mm]	15	20
	Weight [g]	0.2	0.2

1) Is fitted into the suction cup holder.

Material types – Suction cup S

Material	F	N	NA	S	U
Shore hardness	60 ±5	50 ±5	50 ±5	50 ±5	60 ±5
Suction cup	FPM	NBR	BR	VMQ (silicone)	PUR
	Colour: grey	Colour: black	Colour: black/white dot	Colour: transparent	Colour: blue
Screwed plug	Nickel-plated brass				
Note on materials	RoHS-compliant				

Operating and environmental conditions – Suction cup S

Material	F	N	NA	S	U
Operating medium	Atmospheric air based on ISO 8573-1:2010 [7:--]				
Ambient temperature [°C]	–10 ... +200	–10 ... +70	–10 ... +70	–30 ... +180	–20 ... +60
Corrosion resistance class CRC ¹⁾	1 - Low corrosion stress				
Special characteristics	–	–	Antistatic	–	–
Food-safe	–	–	–	As per manufacturer's declaration	–

1) More information: www.festo.com/x/topic/crc

Datasheet – Holder size 2

General technical data – Suction cup holder HA/HB/HC/HCL		Datasheets → Internet: esh	
Vacuum port [1]		QS-6	PK-4
HA – Vacuum port on top, mounting with lock nut, without height compensator			
	Mounting thread [2]	M10x1	M8x0.75
	Suction cup mounting [3]	\varnothing 4 mm	\varnothing 4 mm
	Nominal width [mm]	2	2
	Volume [cm ³]	0.501	0.169
	Ambient temperature [°C]	0 ... +60	-10 ... +60
	Weight [g]	12	7
	Materials of holder	Tempered steel, high-alloy steel, POM	Tempered steel, high-alloy steel
	Seal materials	NBR	NBR, steel
	Note on materials	RoHS-compliant	RoHS-compliant
HB – Vacuum port on the side, mounting with female thread, without height compensator			
	Mounting thread [2]	M4	M4
	Suction cup mounting [3]	\varnothing 4 mm	\varnothing 4 mm
	Nominal width [mm]	2	2
	Volume [cm ³]	0.418	0.188
	Ambient temperature [°C]	0 ... +60	-10 ... +60
	Weight [g]	13	11
	Materials of holder	Tempered steel, high-alloy steel, POM	Tempered steel, high-alloy steel
	Seal materials	NBR, steel	NBR, steel
	Note on materials	RoHS-compliant	RoHS-compliant
HC – Vacuum port on top, mounting with lock nut, with height compensator			
	Mounting thread [2]	M12x1	M8x0.75
	Suction cup mounting [3]	\varnothing 4 mm	\varnothing 4 mm
	Nominal width [mm]	2.2	1.2
	Volume [cm ³]	0.551	0.192
	Height compensator [mm]	3	3
	Spring force (normal/min. length) [N]	Max. 1	Max. 1
	Ambient temperature [°C]	0 ... +60	-10 ... +60
	Weight [g]	18	8
	Materials of holder	Tempered steel, high-alloy steel, POM	Tempered steel, high-alloy steel
Seal materials	NBR, steel	NBR, steel	
Note on materials	RoHS-compliant	RoHS-compliant	
HCL – Vacuum port on top, mounting with lock nut, with long height compensator			
	Mounting thread [2]	M12x1	M12x1
	Suction cup mounting [3]	\varnothing 4 mm	\varnothing 4 mm
	Nominal width [mm]	2.2	2.2
	Volume [cm ³]	0.519	0.398
	Height compensator [mm]	10	10
	Spring force (normal/min. length) [N]	Max. 1	Max. 1
	Ambient temperature [°C]	0 ... +60	-10 ... +60
	Weight [g]	20	19
	Materials of holder	Tempered steel, high-alloy steel, POM	Tempered steel, high-alloy steel
Seal materials	NBR, steel	NBR, steel	
Note on materials	RoHS-compliant	RoHS-compliant	

Datasheet – Holder size 2

General technical data – Suction cup holder HD/HDL		Datasheets → Internet: esh	
Vacuum port [1]		QS-6	PK-4
HD – Vacuum port on the side, mounting with lock nut, with height compensator			
	Mounting thread [2]	M8x0.75	M8x0.75
	Suction cup mounting [3]	\varnothing 4 mm	\varnothing 4 mm
	Nominal width [mm]	1.8	1.8
	Volume [cm ³]	0.417	0.183
	Height compensator [mm]	3	3
	Spring force (normal/min. length) [N]	Max. 1	Max. 1
	Ambient temperature [°C]	0 ... +60	-10 ... +60
	Weight [g]	15	12
	Materials of holder	Tempered steel, high-alloy steel, POM	Tempered steel, high-alloy steel
	Seal materials	NBR, steel	NBR, steel
Note on materials	RoHS-compliant	RoHS-compliant	
HDL – Vacuum port on the side, mounting with lock nut, with long height compensator			
	Mounting thread [2]	M12x1	M12x1
	Suction cup mounting [3]	\varnothing 4 mm	\varnothing 4 mm
	Nominal width [mm]	2.2	2.2
	Volume [cm ³]	0.260	0.138
	Height compensator [mm]	10	10
	Spring force (normal/min. length) [N]	Max. 1	Max. 1
	Ambient temperature [°C]	0 ... +60	-10 ... +60
	Weight [g]	33	32
	Materials of holder	Tempered steel, high-alloy steel, POM	Tempered steel, high-alloy steel
	Seal materials	NBR, steel	NBR, steel
Note on materials	RoHS-compliant	RoHS-compliant	
General technical data – Suction cup holder HE		Datasheets → Internet: esh	
Vacuum port [1]		M5	
HE – Vacuum port on top, with threaded connection for direct screw-in, without height compensator			
	Mounting thread [2]	M5	
	Suction cup mounting [3]	\varnothing 4 mm	
	Nominal width [mm]	2	
	Volume [cm ³]	0.036	
	Ambient temperature [°C]	-10 ... +60	
	Weight [g]	3	
	Materials of holder	Tempered steel	
	Seal materials	NBR, steel, wrought aluminium alloy, POM	
Note on materials	RoHS-compliant		
General technical data – Suction cup holder HF		Datasheets → Internet: esh	
Vacuum port [1]		M10x1	
HF – Vacuum port on top, with threaded connection for direct screw-in, with height compensator			
	Mounting thread [2]	M10x1	
	Suction cup mounting [3]	\varnothing 4 mm	
	Nominal width [mm]	2	
	Volume [cm ³]	0.09	
	Height compensator [mm]	2.6	
	Spring force (normal/min. length) [N]	2/4	
	Ambient temperature [°C]	-10 ... +60	
	Weight [g]	14	
	Materials of holder	Tempered steel	
	Seal materials	NBR, POM	
Note on materials	RoHS-compliant		

Datasheet – Holder size 3

Holder size 3

For suction cup \varnothing 10/15 mm



Suction cup shape:

- Round, flat
- Round, extra-deep
- Round, bellows with 1.5 convolutions
- Round, bellows with 3.5 convolutions



General technical data – Suction cup S/E/B/C

Datasheets → Internet: [ess](http://ess.festo.com)

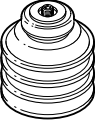
Suction cup shape		Suction cup \varnothing [mm]	
		10	15
S – round, flat: material FPM, NBR, BR, VMQ (silicone), PUR			
	Connection suction cup holder	M4	M4
	Nominal width [mm]	2	2
	Holding force at nominal operating pressure –0.7 bar [N]	3.9	8.5
	Suction cup volume [cm ³]	0.050	0.208
	Min. workpiece radius [mm]	30	35
	Weight [g]	1.5	1.9
E – round, extra deep: material FPM, NBR, VMQ (silicone), PUR			
	Connection suction cup holder	–	M4
	Nominal width [mm]	–	2
	Holding force at nominal operating pressure –0.7 bar [N]	–	9.8
	Suction cup volume [cm ³]	–	0.350
	Min. workpiece radius [mm]	–	20
	Weight [g]	–	1.9
B – round, bellows 1.5 convolutions: material NBR, VMQ (silicone), PUR			
	Connection suction cup holder	M4	–
	Nominal width [mm]	2	–
	Holding force at nominal operating pressure –0.7 bar [N]	4.7	–
	Suction cup volume [cm ³]	0.380	–
	Min. workpiece radius [mm]	20	–
	Height compensator [mm]	4	–
	Weight [g]	1.8	–
C – round, bellows 3.5 convolutions: material NBR, VMQ (silicone)			
	Connection suction cup holder	M4	–
	Nominal width [mm]	2	–
	Holding force at nominal operating pressure –0.7 bar [N]	3.9	–
	Suction cup volume [cm ³]	0.290	–
	Min. workpiece radius [mm]	25	–
	Height compensator [mm]	3.3	–
	Weight [g]	1.6	–

Datasheet – Holder size 3

Material types – Suction cup					
Material	F	N	NA	S	U
Shore hardness	60 \pm 5	60 \pm 5	50 \pm 5	50 \pm 5	60 \pm 5
Suction cup	FPM	NBR	BR	VMQ (silicone)	PUR
	Colour: grey	Colour: black	Colour: black/white dot	Colour: transparent	Colour: blue
Screwed plug	Nickel-plated brass				
Note on materials	RoHS-compliant				

Operating and environmental conditions – Suction cup					
Material	F	N	NA	S	U
Operating medium	Atmospheric air based on ISO 8573-1:2010 [7:--:--]				
Ambient temperature [°C]	-10 ... +200	-10 ... +70	-10 ... +70	-30 ... +180	-20 ... +60
Corrosion resistance class CRC ¹⁾	1 - Low corrosion stress				
Special characteristics	-	-	Antistatic	-	-
Food-safe	-	-	-	As per manufacturer's declaration	-

1) More information: www.festo.com/x/topic/crc

Datasheet – Holder size 3

General technical data – Suction cup holder HA/HB/HC/HCL

Datasheets → Internet: esh

Vacuum port [1]	QS-6	PK-4	
HA – Vacuum port on top, mounting with lock nut, without height compensator			
	Mounting thread [2]	M12x1	M8x0.75
	Suction cup mounting [3]	M4	M4
	Nominal width [mm]	5	2.5
	Volume [cm ³]	0.520	0.274
	Ambient temperature [°C]	0 ... +60	-10 ... +60
	Weight [g]	20	10
	Materials of holder	Tempered steel, high-alloy steel, POM	Tempered steel, high-alloy steel
	Seal materials	NBR	NBR, steel
	Note on materials	RoHS-compliant	RoHS-compliant
HB – Vacuum port on the side, mounting with female thread, without height compensator			
	Mounting thread [2]	M6	M6
	Suction cup mounting [3]	M4	M4
	Nominal width [mm]	3.3	2.5
	Volume [cm ³]	0.539	0.313
	Ambient temperature [°C]	0 ... +60	-10 ... +60
	Weight [g]	29	27
	Materials of holder	Tempered steel, high-alloy steel, POM	Tempered steel, high-alloy steel
	Seal materials	NBR, steel	NBR, steel
	Note on materials	RoHS-compliant	RoHS-compliant
HC – Vacuum port on top, mounting with lock nut, with height compensator			
	Mounting thread [2]	M14x1	M14x1
	Suction cup mounting [3]	M4	M4
	Nominal width [mm]	3.4	2.5
	Volume [cm ³]	1.041	0.789
	Height compensator [mm]	6	6
	Spring force (normal/min. length) [N]	2/5	2/5
	Ambient temperature [°C]	0 ... +60	-10 ... +60
	Weight [g]	34	32
	Materials of holder	Tempered steel, high-alloy steel, POM	Tempered steel, high-alloy steel
Seal materials	NBR, steel	NBR, steel	
Note on materials	RoHS-compliant	RoHS-compliant	
HCL – Vacuum port on top, mounting with lock nut, with long height compensator			
	Mounting thread [2]	M14x1	M14x1
	Suction cup mounting [3]	M4	M4
	Nominal width [mm]	3.4	3
	Volume [cm ³]	1.616	1.383
	Height compensator [mm]	20	20
	Spring force (normal/min. length) [N]	1/3	1/3
	Ambient temperature [°C]	0 ... +60	-10 ... +60
	Weight [g]	48	46
	Materials of holder	Tempered steel, high-alloy steel, POM	Tempered steel, high-alloy steel
Seal materials	NBR, steel	NBR, steel	
Note on materials	RoHS-compliant	RoHS-compliant	

Datasheet – Holder size 3

General technical data – Suction cup holder HD/HDL		Datasheets → Internet: esh	
Vacuum port [1]		QS-6	PK-4
HD – Vacuum port on the side, mounting with lock nut, with height compensator			
	Mounting thread [2]	M14x1	M14x1
	Suction cup mounting [3]	M4	M4
	Nominal width [mm]	3.3	3
	Volume [cm ³]	0.573	0.343
	Height compensator [mm]	6	6
	Spring force (normal/min. length) [N]	2/5	2/5
	Ambient temperature [°C]	0 ... +60	-10 ... +60
	Weight [g]	46	44
	Materials of holder	Tempered steel, high-alloy steel, POM	Tempered steel, high-alloy steel
	Seal materials	NBR, steel	NBR, steel
	Note on materials	RoHS-compliant	RoHS-compliant
HDL – Vacuum port on the side, mounting with lock nut, with long height compensator			
	Mounting thread [2]	M14x1	M14x1
	Suction cup mounting [3]	M4	M4
	Nominal width [mm]	3.3	3
	Volume [cm ³]	0.474	0.252
	Height compensator [mm]	20	20
	Spring force (normal/min. length) [N]	1/3	1/3
	Ambient temperature [°C]	0 ... +60	-10 ... +60
	Weight [g]	65	63
	Materials of holder	Tempered steel, high-alloy steel, POM	Tempered steel, high-alloy steel
	Seal materials	NBR, steel	NBR, steel
	Note on materials	RoHS-compliant	RoHS-compliant
General technical data – Suction cup holder HE		Datasheets → Internet: esh	
Vacuum port [1]		G1/8	
HE – Vacuum port on top, with threaded connection for direct screw-in, without height compensator			
	Mounting thread [2]	G1/8	
	Suction cup mounting [3]	M4	
	Nominal width [mm]	3	
	Volume [cm ³]	0.106	
	Ambient temperature [°C]	-10 ... +60	
	Weight [g]	11	
	Materials of holder	Tempered steel	
	Seal materials	NBR, steel, wrought aluminium alloy, POM	
Note on materials	RoHS-compliant		
General technical data – Suction cup holder HF		Datasheets → Internet: esh	
Vacuum port [1]		M14x1	
HF – Vacuum port on top, with threaded connection for direct screw-in, with height compensator			
	Mounting thread [2]	M14x1	
	Suction cup mounting [3]	M4	
	Nominal width [mm]	3.3	
	Volume [cm ³]	0.400	
	Height compensator [mm]	6	
	Spring force (normal/min. length) [N]	6/12	
	Ambient temperature [°C]	-10 ... +60	
	Weight [g]	54	
	Materials of holder	Tempered steel	
	Seal materials	NBR, POM	
	Note on materials	RoHS-compliant	

Datasheet – Holder size 3

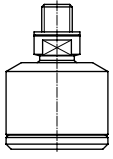
Angle compensator ESWA		Datasheets → Internet: eswa
	Pneumatic connection	M4
	Design	Ball joint
	Angle compensator +/-	[°] 15
	Operating pressure	[bar] -0.95 ... +4
	Ambient temperature	[°C] 0 ... +60
	Weight	[g] 9
	Housing materials	Aluminium, nickel-plated brass
	Seal materials	NBR
	Note on materials	RoHS-compliant

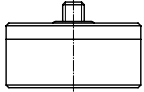
Vacuum filter ESF		Datasheets → Internet: esf
	Pneumatic connection	M4
	Flow rate at vacuum pressure =-0.75 bar	[l/min] 100
	Grade of filtration	[μ m] 10
	Operating pressure	[bar] -0.95 ... +4
	Ambient temperature	[°C] 0 ... +60
	Weight	[g] 9
	Housing materials	Aluminium, nickel-plated brass
	Filter materials	PVF
	Note on materials	RoHS-compliant

Suction-cup insert OASI		Datasheets → Internet: oasi
For round suction cup, bellows 3.5 convolutions	Suction cup \varnothing [mm]	10
	Type of mounting	Plug-in
	Operating pressure	[bar] -0.95 ... 0
	Ambient temperature	[°C] 5 ... +50
	Food-safe	As per manufacturer's declaration
	Weight	[g] 0.1
	Suction cup insert materials	PE
	Note on materials	RoHS-compliant

Datasheet – Holder size 4

Holder size 4

For suction cup \varnothing
20/30/40/50 mm
and



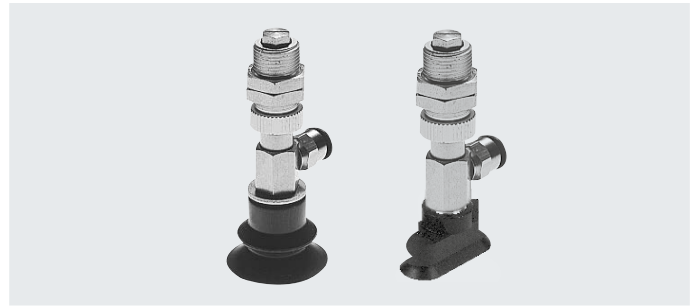

Suction cup size 4x10/4x20/6x-
10/6x20/8x20/8x30/10x30 mm

Suction cup shape:

- Round, flat
- Round, extra-deep
- Round, bellows with 1.5 convolutions
- Round, bellows with 3.5 convolutions
- Round, deep
- Oval, flat

**General technical data – Suction cup S/E/B/C/G**

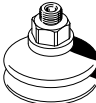
Datasheets → Internet: ess

Suction cup shape		Suction cup \varnothing [mm]			
		20	30	40	50
S – round, flat: material FPM, NBR, BR, VMQ (silicone), PUR					
	Connection suction cup holder	M6	M6	M6	M6
	Nominal width [mm]	3	3	3	3
	Holding force at nominal operating pressure –0.7 bar [N]	16.3	40.8	69.6	105.8
	Suction cup volume [cm ³]	0.318	0.867	1.566	2.387
	Min. workpiece radius [mm]	60	110	230	330
	Weight [g]	6.4	9	16.3	22
E – round, extra deep: material FPM, NBR, VMQ (silicone), PUR					
	Connection suction cup holder	M6	M6	M6	M6
	Nominal width [mm]	3	3	3	3
	Holding force at nominal operating pressure –0.7 bar [N]	17	37.2	67.6	103.6
	Suction cup volume [cm ³]	0.84	2.12	4.04	7.9
	Min. workpiece radius [mm]	30	50	80	100
	Weight [g]	6.4	9.2	16.9	23.4
B – round, bellows 1.5 convolutions: material NBR, VMQ (silicone), PUR, Vulkollan® (technical values in brackets)					
	Connection suction cup holder	M6	M6	M6	M6
	Nominal width [mm]	3	3	3 (2.5)	3 (2.5)
	Holding force at nominal operating pressure –0.7 bar [N]	12.9	26.2	52.3 (59)	72.6 (100)
	Suction cup volume [cm ³]	1.6	4.07	8.87 (9.8)	14.23 (17.6)
	Min. workpiece radius [mm]	40	80	90 (35)	150 (40)
	Height compensator [mm]	6	8	9.5 (9)	11 (10)
	Weight [g]	6.7	9.9	18.7 (18)	24.7 (24)
C – round, bellows 3.5 convolutions: material NBR, VMQ (silicone)					
	Connection suction cup holder	M6	M6	M6	M6
	Nominal width [mm]	3	3	3	3
	Holding force at nominal operating pressure –0.7 bar [N]	8.2	20.8	42.4	63.4
	Suction cup volume [cm ³]	2.75	9.47	19.72	38.92
	Min. workpiece radius [mm]	50	80	100	180
	Height compensator [mm]	7	10.5	12.8	17.5
	Weight [g]	6.9	12.2	21.9	32.1
G – round, deep: material Vulkollan®					
	Connection suction cup holder	–	M6	M6	M6
	Nominal width [mm]	–	2.5	2.5	2.5
	Holding force at nominal operating pressure –0.7 bar [N]	–	36	64	97
	Suction cup volume [cm ³]	–	2.4	5.4	11.2
	Min. workpiece radius [mm]	–	26	35	40
	Height compensator [mm]	–	3.5	5.5	8
	Weight [g]	–	12	14	17

® Registered trademark of the Bayer MaterialScience AG Group

Suction gripper ESG, suction cup \varnothing 20/30/40/50 mm, oval

Datasheet – Holder size 4

General technical data – Suction cup O

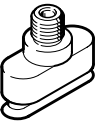
Suction cup shape		Suction cup size [mm]						
		4x10	4x20	6x10	6x20	8x20	8x30	10x30
O – oval, flat: material NBR								
	Connection suction cup holder	M6	M6	M6	M6	M6	M6	M6
	Nominal width [mm]	2.5	2.5	2.5	2.5	2.5	2.5	2.5
	Holding force at nominal operating pressure –0.7 bar [N]	2	3.4	2.9	5.9	8	10.9	15.2
	Suction cup volume [cm ³]	0.064	0.112	0.106	0.196	0.256	0.376	0.350
	Weight [g]	2	2.5	2	2.5	2.5	3	2.9

Material types – Suction cup

Material	F	N	NA	S	U	T
Shore hardness	60 ±5	60 ±5	50 ±5	50 ±5	60 ±5	72 ±5
Suction cup	FPM	NBR	BR	VMQ (silicone)	PUR	Vulkollan®
	Colour: grey	Colour: black	Colour: black/white dot	Colour: transparent	Colour: blue	Colour: reddish brown
Threaded plug for suction cup \varnothing [mm]	20, 30	Nickel-plated brass				Wrought aluminium alloy
		Galvanised and chrome-plated steel				
	40, 50	Nickel-plated brass				Wrought aluminium alloy
		Galvanised and chrome-plated steel				
Note on materials	RoHS-compliant					

Operating and environmental conditions – Suction cup

Material	F	N	NA	S	U	T
Operating medium	Atmospheric air based on ISO 8573-1:2010 [7:--]					
Ambient temperature [°C]	–10 ... +200	–10 ... +70	–10 ... +70	–30 ... +180	–20 ... +60	–10 ... +80
Corrosion resistance class CRC ¹⁾	1 - Low corrosion stress					2 - Moderate corrosion stress
Special characteristics	–	–	Antistatic	–	–	–
Food-safe	–	–	–	As per manufacturer's declaration	–	–

1) More information: www.festo.com/x/topic/crc

® Registered trademark of the Bayer MaterialScience AG Group

Datasheet – Holder size 4

General technical data – Suction cup holder HA/HB/HC/HCL		Datasheets → Internet: esh	
Vacuum port [1]		QS-6	PK-4
HA – Vacuum port on top, mounting with lock nut, without height compensator			
	Mounting thread [2]	M14x1	M12x1
	Suction cup mounting [3]	M6	M6
	Nominal width [mm]	5	2.5
	Volume [cm ³]	0.719	0.668
	Ambient temperature [°C]	0 ... +60	-10 ... +60
	Weight [g]	30	23
	Materials of holder	Tempered steel, high-alloy steel, POM	Tempered steel, high-alloy steel
	Seal materials	NBR	NBR, steel
	Note on materials	RoHS-compliant	RoHS-compliant
HB – Vacuum port on the side, mounting with female thread, without height compensator			
	Mounting thread [2]	M6	M6
	Suction cup mounting [3]	M6	M6
	Nominal width [mm]	5	2.5
	Volume [cm ³]	0.646	0.416
	Ambient temperature [°C]	0 ... +60	-10 ... +60
	Weight [g]	27	25
	Materials of holder	Tempered steel, high-alloy steel, POM	Tempered steel, high-alloy steel
	Seal materials	NBR, steel	NBR, steel
	Note on materials	RoHS-compliant	RoHS-compliant
HC – Vacuum port on top, mounting with lock nut, with height compensator			
	Mounting thread [2]	M14x1	M14x1
	Suction cup mounting [3]	M6	M6
	Nominal width [mm]	3.4	2.5
	Volume [cm ³]	1.153	0.911
	Height compensator [mm]	6	6
	Spring force (normal/min. length) [N]	5/10	5/10
	Ambient temperature [°C]	0 ... +60	-10 ... +60
	Weight [g]	33	31
	Materials of holder	Tempered steel, high-alloy steel, POM	Tempered steel, high-alloy steel
Seal materials	NBR, steel	NBR, steel	
Note on materials	RoHS-compliant	RoHS-compliant	
HCL – Vacuum port on top, mounting with lock nut, with long height compensator			
	Mounting thread [2]	M14x1	M14x1
	Suction cup mounting [3]	M6	M6
	Nominal width [mm]	3.4	3
	Volume [cm ³]	1.780	1.535
	Height compensator [mm]	20	20
	Spring force (normal/min. length) [N]	1/9	1/9
	Ambient temperature [°C]	0 ... +60	-10 ... +60
	Weight [g]	47	45
	Materials of holder	Tempered steel, high-alloy steel, POM	Tempered steel, high-alloy steel
Seal materials	NBR, steel	NBR, steel	
Note on materials	RoHS-compliant	RoHS-compliant	

Datasheet – Holder size 4

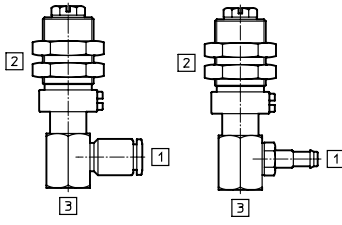
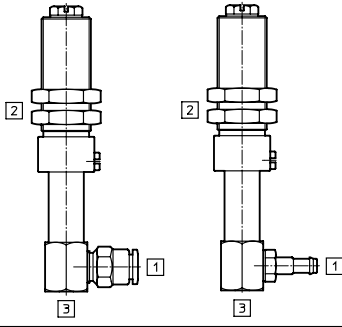
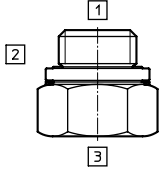
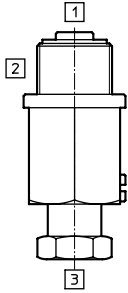
General technical data – Suction cup holder HD/HDL		Datasheets → Internet: esh	
Vacuum port [1]		QS-6	PK-4
HD – Vacuum port on the side, mounting with lock nut, with height compensator			
	Mounting thread [2]	M14x1	M14x1
	Suction cup mounting [3]	M6	M6
	Nominal width [mm]	5	3
	Volume [cm ³]	0.678	0.449
	Height compensator [mm]	6	6
	Spring force (normal/min. length) [N]	5/10	5/10
	Ambient temperature [°C]	0 ... +60	-10 ... +60
	Weight [g]	45	43
	Materials of holder	Tempered steel, high-alloy steel, POM	Tempered steel, high-alloy steel
	Seal materials	NBR, steel	NBR, steel
Note on materials	RoHS-compliant	RoHS-compliant	
HDL – Vacuum port on the side, mounting with lock nut, with long height compensator			
	Mounting thread [2]	M14x1	M14x1
	Suction cup mounting [3]	M6	M6
	Nominal width [mm]	5	3
	Volume [cm ³]	0.370	0.448
	Height compensator [mm]	20	20
	Spring force (normal/min. length) [N]	1/9	1/9
	Ambient temperature [°C]	0 ... +60	-10 ... +60
	Weight [g]	65	63
	Materials of holder	Tempered steel, high-alloy steel, POM	Tempered steel, high-alloy steel
	Seal materials	NBR, steel	NBR, steel
Note on materials	RoHS-compliant	RoHS-compliant	
General technical data – Suction cup holder HE		Datasheets → Internet: esh	
Vacuum port [1]		G1/8	
HE – Vacuum port on top, with threaded connection for direct screw-in, without height compensator			
	Mounting thread [2]	G1/8	
	Suction cup mounting [3]	M6	
	Nominal width [mm]	4	
	Volume [cm ³]	0.289	
	Ambient temperature [°C]	-10 ... +60	
	Weight [g]	11	
	Materials of holder	Tempered steel	
	Seal materials	NBR, steel, wrought aluminium alloy, POM	
Note on materials	RoHS-compliant		
General technical data – Suction cup holder HF		Datasheets → Internet: esh	
Vacuum port [1]		M14x1	
HF – Vacuum port on top, with threaded connection for direct screw-in, with height compensator			
	Mounting thread [2]	M14x1	
	Suction cup mounting [3]	M6	
	Nominal width [mm]	4	
	Volume [cm ³]	0.655	
	Height compensator [mm]	6	
	Spring force (normal/min. length) [N]	6/12	
	Ambient temperature [°C]	-10 ... +60	
	Weight [g]	52	
	Materials of holder	Tempered steel	
	Seal materials	NBR, POM	
Note on materials	RoHS-compliant		

Datasheet – Holder size 4

Angle compensator ESWA

Datasheets → Internet: eswa

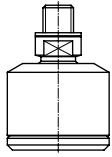

Pneumatic connection		M6
Design		Ball joint
Angle compensator +/-	[°]	15
Operating pressure	[bar]	-0.95 ... +4
Ambient temperature	[°C]	0 ... +60
Weight	[g]	19
Housing materials		Aluminium, nickel-plated brass
Seal materials		NBR
Note on materials		RoHS-compliant

Vacuum filter ESF

Datasheets → Internet: esf

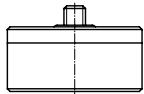

		Suction cup \varnothing 20 mm, Suction cup size 4x10 ... 10x30 mm	Suction cup \varnothing 30/40/50 mm
Pneumatic connection		M6	
Flow rate at vacuum pressure =-0.75 bar	[l/min]	260	270
Grade of filtration	[μ m]	10	
Operating pressure	[bar]	-0.95 ... +4	
Ambient temperature	[°C]	0 ... +60	
Weight	[g]	19	
Housing materials		Aluminium, nickel-plated brass	
Filter materials		PVF	
Seal materials		NBR	
Note on materials		RoHS-compliant	

Suction-cup insert OASI

Datasheets → Internet: oasi

For round suction cup, bellows 3.5 convolutions



		Suction cup \varnothing [mm]			
		20	30	40	50
Type of mounting		Plug-in			
Operating pressure	[bar]	-0.95 ... 0			
Ambient temperature	[°C]	5 ... +50			
Food-safe		As per manufacturer's declaration			
Weight	[g]	0.6	2.1	2.9	5.9
Suction cup insert materials		PE			
Note on materials		RoHS-compliant			

Datasheet – Holder size 5

Holder size 5

For suction cup \varnothing 60/80/100 mm and suction cup size 15x45/20x60/25x75/30x90 mm

Suction cup shape:

- Round, flat
- Round, extra-deep
- Round, bellows with 1.5 convolutions
- Round, deep
- Oval, flat

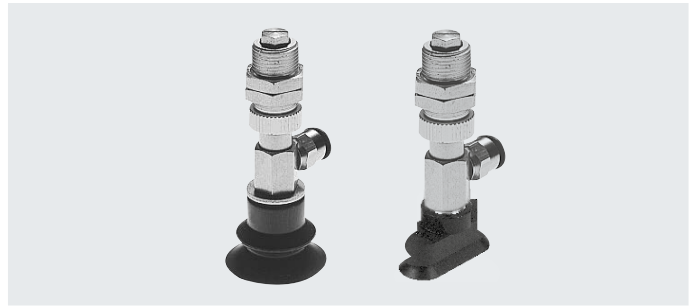

General technical data – Suction cup S/E/B/G

Datasheets → Internet: ess

Suction cup shape	Suction cup \varnothing [mm]		
	60	80	100

S – round, flat: material FPM, NBR, VMQ (silicone), PUR

	Connection suction cup holder	M10	M10	M10
	Nominal width [mm]	6	6	6
	Holding force at nominal operating pressure –0.7 bar [N]	166.1	309.7	503.6
	Suction cup volume [cm ³]	3.953	19.312	29.779
	Min. workpiece radius [mm]	350	400	460
	Weight [g]	49	133	222

E – round, extra deep: material FPM, NBR, VMQ (silicone), PUR

	Connection suction cup holder	M10	M10	M10
	Nominal width [mm]	6	6	6
	Holding force at nominal operating pressure –0.7 bar [N]	162.5	275	440.8
	Suction cup volume [cm ³]	19.77	51.61	84.66
	Min. workpiece radius [mm]	120	160	200
	Weight [g]	48	141	228

B – round, bellows 1.5 convolutions: material NBR, VMQ (silicone), PUR, Vulkollan® (technical values in brackets)

	Connection suction cup holder	–	M10	–
	Nominal width [mm]	–	6 (2.5)	–
	Holding force at nominal operating pressure –0.7 bar [N]	–	213.6 (237)	–
	Suction cup volume [cm ³]	–	63.9 (59.1)	–
	Min. workpiece radius [mm]	–	430 (100)	–
	Height compensator [mm]	–	10 (10.5)	–
	Weight [g]	–	139 (84.5)	–

G – round, deep: material Vulkollan®

	Connection suction cup holder	M10	M10	M10
	Nominal width [mm]	2.5	5.5	5.5
	Holding force at nominal operating pressure –0.7 bar [N]	134	245	375
	Suction cup volume [cm ³]	11.3	28.6	53.9
	Min. workpiece radius [mm]	75	100	135
	Height compensator [mm]	6	7.5	9
	Weight [g]	20	28	86.5

General technical data – Suction cup O

Suction cup shape	Suction cup size [mm]			
	15x45	20x60	25x75	30x90

O – oval, flat: material NBR

	Connection suction cup holder	M10	M10	M10	M10
	Nominal width [mm]	6	6	6	6
	Holding force at nominal operating pressure –0.7 bar [N]	32	62.8	92.5	134.4
	Suction cup volume [cm ³]	1.57	3.69	6.7	10.17
	Weight [g]	23.8	30.8	46.8	55.3

® Registered trademark of the Bayer MaterialScience AG Group

Datasheet – Holder size 5

Material types – Suction cup					
Material	F	N	S	U	T
Shore hardness	60 \pm 5	60 \pm 5	50 \pm 5	60 \pm 5	72 \pm 5
Suction cup	FPM	NBR	VMQ (silicone)	PUR	Vulkollan®
	Colour: grey	Colour: black	Colour: transparent	Colour: blue	Colour: reddish brown
Threaded plug for suction cup \varnothing [mm]	60	Nickel-plated steel			Wrought aluminium alloy
		Nickel-plated wrought aluminium alloy			
		Galvanised and chrome-plated steel			
	80, 100	Nickel-plated steel			Wrought aluminium alloy
		POM			
		Galvanised and chrome-plated steel			
Note on materials	RoHS-compliant				

Operating and environmental conditions – Suction cup					
Material	F	N	S	U	T
Operating medium	Atmospheric air based on ISO 8573-1:2010 [7:--]				
Ambient temperature [°C]	-10 ... +200	-10 ... +70	-30 ... +180	-20 ... +60	-10 ... +80
Corrosion resistance class CRC ¹⁾	1 - Low corrosion stress				2 - Moderate corrosion stress
Food-safe	-	-	As per manufacturer's declaration	-	-

1) More information: www.festo.com/x/topic/crc

® Registered trademark of the Bayer MaterialScience AG Group

Datasheet – Holder size 5

General technical data – Suction cup holder HA/HB/HC/HCL

Datasheets → Internet: esh

Vacuum port [1] | G1/8

HA – Vacuum port on top, mounting with lock nut, without height compensator

	Mounting thread [2]	M20x1
	Suction cup mounting [3]	M10
	Nominal width [mm]	8
	Volume [cm ³]	1.862
	Ambient temperature [°C]	-10 ... +60
	Weight [g]	84
	Materials of holder	Tempered steel, high-alloy steel
	Note on materials	RoHS-compliant

HB – Vacuum port on the side, mounting with female thread, without height compensator

	Mounting thread [2]	M8
	Suction cup mounting [3]	M10
	Nominal width [mm]	8.5
	Volume [cm ³]	1.921
	Ambient temperature [°C]	-10 ... +60
	Weight [g]	91
	Materials of holder	Tempered steel, high-alloy steel
	Note on materials	RoHS-compliant

HC – Vacuum port on top, mounting with lock nut, with height compensator

	Mounting thread [2]	M22x1
	Suction cup mounting [3]	M10
	Nominal width [mm]	8.4
	Volume [cm ³]	3.327
	Height compensator [mm]	10
	Spring force (normal/min. length) [N]	8/18
	Ambient temperature [°C]	-10 ... +60
	Weight [g]	112
	Note on materials	RoHS-compliant

HCL – Vacuum port on top, mounting with lock nut, with long height compensator

	Mounting thread [2]	M22x1
	Suction cup mounting [3]	M10
	Nominal width [mm]	8.4
	Volume [cm ³]	6.06
	Height compensator [mm]	30
	Spring force (normal/min. length) [N]	10/16
	Ambient temperature [°C]	-10 ... +60
	Weight [g]	169
	Note on materials	RoHS-compliant

Datasheet – Holder size 5

General technical data – Suction cup holder HD/HDL		Datasheets → Internet: esh
Vacuum port [1]	G1/8	

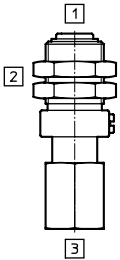
HD – Vacuum port on the side, mounting with lock nut, with height compensator		
	Mounting thread [2]	M22x1
	Suction cup mounting [3]	M10
	Nominal width [mm]	8.5
	Volume [cm ³]	2.072
	Height compensator [mm]	10
	Spring force (normal/min. length) [N]	8/18
	Ambient temperature [°C]	-10 ... +60
	Weight [g]	195
	Materials of holder	Tempered steel, high-alloy steel
	Note on materials	RoHS-compliant

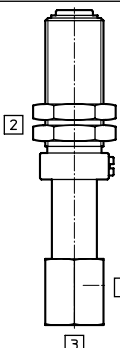
HDL – Vacuum port on the side, mounting with lock nut, with long height compensator		
	Mounting thread [2]	M22x1
	Suction cup mounting [3]	M10
	Nominal width [mm]	8.5
	Volume [cm ³]	1.667
	Height compensator [mm]	30
	Spring force (normal/min. length) [N]	10/16
	Ambient temperature [°C]	-10 ... +60
	Weight [g]	273
	Materials of holder	Tempered steel, high-alloy steel
	Note on materials	RoHS-compliant

General technical data – Suction cup holder HE		Datasheets → Internet: esh
Vacuum port [1]	G1/4	

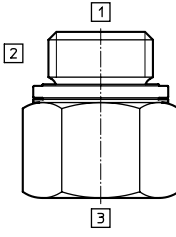
HE – Vacuum port on top, with threaded connection for direct screw-in, without height compensator		
	Mounting thread [2]	G1/4
	Suction cup mounting [3]	M10
	Nominal width [mm]	7
	Volume [cm ³]	1.227
	Ambient temperature [°C]	-10 ... +60
	Weight [g]	24
	Materials of holder	Tempered steel
	Seal materials	NBR, steel, wrought aluminium alloy, POM
Note on materials	RoHS-compliant	

Angle compensator ESWA		Datasheets → Internet: eswa
-------------------------------	--	-----------------------------

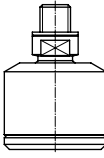
	Pneumatic connection	M10
	Design	Ball joint
	Angle compensator +/- [°]	15
	Operating pressure [bar]	-0.95 ... +4
	Ambient temperature [°C]	0 ... +60
	Weight [g]	57
	Housing materials	Aluminium, nickel-plated brass
	Seal materials	NBR
Note on materials	RoHS-compliant	

Datasheet – Holder size 6

Holder size 6

For suction cup \varnothing 150/200 mm

Suction cup shape:

- Round, flat



General technical data – Suction cup S

Datasheets → Internet: [ess](#)

Suction cup shape	Suction cup \varnothing [mm]	
	150	200

S – round, flat: material FPM, NBR, VMQ (silicone), PUR

	Connection suction cup holder	M20x2	M20x2
	Nominal width [mm]	10	10
	Holding force at nominal operating pressure –0.7 bar [N]	900	1610
	Suction cup volume [cm ³]	173.826	245.454
	Min. workpiece radius [mm]	480	680
	Weight [g]	719	1198

Material types – Suction cup S

Material	F	N	S	U
Shore hardness	60 ±5	50 ±5	50 ±5	60 ±5
Suction cup	FPM	NBR	VMQ (silicone)	PUR
	Colour: grey	Colour: black	Colour: transparent	Colour: blue
Screwed plug	Nickel-plated steel			
	NBR			
	Galvanised and chrome-plated steel			
Note on materials	RoHS-compliant			

Operating and environmental conditions – Suction cup S

Material	F	N	S	U
Operating medium	Atmospheric air based on ISO 8573-1:2010 [7:--]			
Ambient temperature [°C]	–10 ... +200	–10 ... +70	–30 ... +180	–20 ... +60
Corrosion resistance class CRC ¹⁾	1 - Low corrosion stress			
Food-safe	–	–	As per manufacturer's declaration	–

1) More information: www.festo.com/x/topic/crc

Datasheet – Holder size 6

Datasheets → Internet: esh

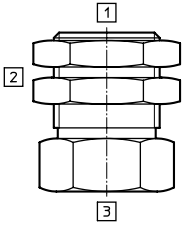
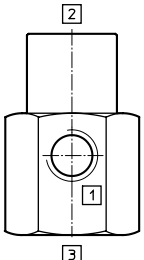
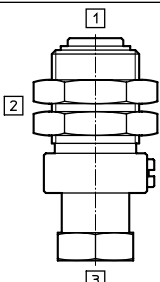
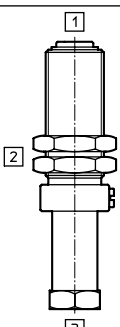
General technical data – Suction cup holder HA/HB/HC/HCL		Vacuum port [1]	G1/4
HA – Vacuum port on top, mounting with lock nut, without height compensator			
	Mounting thread [2]	M24x2	
	Suction cup mounting [3]	M20x2	
	Nominal width [mm]	10	
	Volume [cm ³]	7.234	
	Ambient temperature [°C]	-10 ... +60	
	Weight [g]	200	
	Materials of holder	Tempered steel, high-alloy steel	
	Note on materials	RoHS-compliant	
HB – Vacuum port on the side, mounting with female thread, without height compensator			
	Mounting thread [2]	M16	
	Suction cup mounting [3]	M20x2	
	Nominal width [mm]	10	
	Volume [cm ³]	7.250	
	Ambient temperature [°C]	-10 ... +60	
	Weight [g]	271	
	Materials of holder	Tempered steel, high-alloy steel	
	Note on materials	RoHS-compliant	
HC – Vacuum port on top, mounting with lock nut, with height compensator			
	Mounting thread [2]	M30x2	
	Suction cup mounting [3]	M20x2	
	Nominal width [mm]	10	
	Volume [cm ³]	11.537	
	Height compensator [mm]	20	
	Spring force (normal/min. length) [N]	12/22	
	Ambient temperature [°C]	-10 ... +60	
	Weight [g]	472	
	Materials of holder	Tempered steel, high-alloy steel	
	Note on materials	RoHS-compliant	
HCL – Vacuum port on top, mounting with lock nut, with long height compensator			
	Mounting thread [2]	M30x2	
	Suction cup mounting [3]	M20x2	
	Nominal width [mm]	10	
	Volume [cm ³]	16.325	
	Height compensator [mm]	40	
	Spring force (normal/min. length) [N]	15/32	
	Ambient temperature [°C]	-10 ... +60	
	Weight [g]	560	
	Materials of holder	Tempered steel, high-alloy steel	
	Note on materials	RoHS-compliant	

Datasheet – Holder size 6

General technical data – Suction cup holder HD/HDL

Vacuum port [1] | G1/4

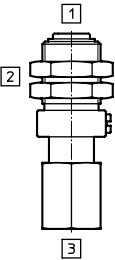
HD – Vacuum port on the side, mounting with lock nut, with height compensator		
	Mounting thread [2]	M30x2
	Suction cup mounting [3]	M20x2
	Nominal width [mm]	10
	Volume [cm ³]	13.171
	Height compensator [mm]	20
	Spring force (normal/min. length) [N]	12/22
	Ambient temperature [°C]	-10 ... +60
	Weight [g]	472
	Materials of holder	Tempered steel, high-alloy steel
	Note on materials	RoHS-compliant

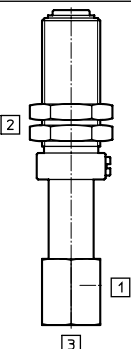
HDL – Vacuum port on the side, mounting with lock nut, with long height compensator		
	Mounting thread [2]	M30x2
	Suction cup mounting [3]	M20x2
	Nominal width [mm]	10
	Volume [cm ³]	16.968
	Height compensator [mm]	40
	Spring force (normal/min. length) [N]	15/32
	Ambient temperature [°C]	-10 ... +60
	Weight [g]	560
	Materials of holder	Tempered steel, high-alloy steel
	Note on materials	RoHS-compliant

Datasheet

Suction grippers ESG – round design

Ordering data – Modular product system

Ordering table – Suction cup \varnothing 2 ... 50 mm												Condi- tions	Code	Enter code	
Size	\varnothing 2	\varnothing 4	\varnothing 6	\varnothing 8	\varnothing 10	\varnothing 15	\varnothing 20	\varnothing 30	\varnothing 40	\varnothing 50					
Holder size	1		2		3		4								
Module no.	189167	189168	189169	189170	189171	189172	189173	189174	189175	189176					
Gripper function	Suction gripper												ESG	ESG	
Suction cup \varnothing [mm]	2	4	6	8	10	15	20	30	40	50			-...		
Suction cup shape/suction cup material	Flat	FPM (fluoro rubber)												-SF	
		NBR (nitrile rubber)												-SN	
		BR (butadiene rubber), anti-static												-SNA	
		VMQ (silicone)												-SS	
		PUR (polyurethane)												-SU	
	Extra deep	-					FPM (fluoro rubber)							-EF	
		-					NBR (nitrile rubber)							-EN	
		-					VMQ (silicone)							-ES	
		-					PUR (polyurethane)							-EU	
	Bellows, 1.5 convolutions	-				NBR	-	NBR (nitrile rubber)						-BN	
		-				VMQ	-	VMQ (silicone)						-BS	
		-				PUR	-	PUR (polyurethane)						-BU	
		-											Vulkollan®		-BT
	Bellows, 3.5 convolutions	-				NBR	-	NBR (nitrile rubber)						-CN	
-				VMQ	-	VMQ (silicone)						-CS			
Deep	-											Vulkollan®		-GT	
Suction cup holder	Male thread, 2 nuts, connection on top												-HA		
	Female thread, connection on the side												-HB		
	Male thread, 2 nuts, connection on top, height compensation												-HC		
	-	Male thread, 2 nuts, connection on top, long height compensation											-HCL		
	Male thread, 2 nuts, connection on the side, height compensation												-HD		
	-	Male thread, 2 nuts, connection on the side, long height compensation											-HDL		
	External thread, port on top, screw-in thread												-HE		
	Male thread, connection at top, screw-in thread, height compensator												-HF		
Vacuum connection	Push-in connector for plastic tubing											[1]	-QS		
	Barbed fitting connection for plastic tubing											[1]	-PK		
Angle compensation	-				Universal joint with 30° deflection								-WA		
Vacuum filter	-				Vacuum filter								-F		
Suction cup insert	-				PE	-	PE					[2]	-ES		

® Registered trademark of the Bayer MaterialScience AG Group

Ordering data – Modular product system

Ordering table – Suction cup ø 60 ... 200 mm								
Size	ø 60	ø 80	ø 100	ø 150	ø 200	Condi- tions	Code	Enter code
Holder size	5			6				
Module no.	189177	189178	189179	189180	189181			
Gripper function	Suction gripper						ESG	ESG
Suction cup ø [mm]	60	80	100	150	200		-...	
Suction cup shape/suction cup material	Flat	FPM (fluoro rubber)					-SF	
		NBR (nitrile rubber)					-SN	
		VMQ (silicone)					-SS	
		PUR (polyurethane)					-SU	
	Extra deep	FPM (fluoro rubber)		-			-EF	
		NBR (nitrile rubber)		-			-EN	
		VMQ (silicone)		-			-ES	
		PUR (polyurethane)		-			-EU	
	Bellows, 1.5 convolutions	-	NBR (nitrile rubber)	-			-BN	
		-	VMQ (silicone)	-			-BS	
		-	PUR (polyurethane)	-			-BU	
		-	Vulkollan®	-			-BT	
	Deep	Vulkollan®		-			-GT	
Suction cup holder	Male thread, 2 nuts, connection on top						-HA	
	Female thread, connection on the side						-HB	
	Male thread, 2 nuts, connection on top, height compensation						-HC	
	Male thread, 2 nuts, connection on top, long height compensation						-HCL	
	Male thread, 2 nuts, connection on the side, height compensation						-HD	
	Male thread, 2 nuts, connection on the side, long height compensation						-HDL	
	External thread, port on top, screw-in thread				-		-HE	
Vacuum connection	Threaded connection					[3]	-G	
Angle compensation	Universal joint with 30° deflection			-			-WA	

[1] QS, PKNot with suction cup holder HE, HF.

[2] ES Can only be selected in combination with suction cup shape/suction cup material CN, CS

[3] G Cannot be combined with suction cup holder HE

® Registered trademark of the Bayer MaterialScience AG Group

Ordering data – Modular product system

Ordering table – Suction cup dimensions 4x10 ... 10x30 mm														
Size (suction cup dimensions)		4x10	4x20	6x10	6x20	8x20	8x30	10x30	Condi- tions	Code	Enter code			
Holder size		4												
Module no.		189182	189183	189184	189185	189186	189187	189188						
Gripper function		Suction gripper								ESG		ESG		
Suction cup size [mm]		4x10	4x20	6x10	6x20	8x20	8x30	10x30		-...				
Suction cup shape/suction cup material		Flat	NBR (nitrile rubber)										-ON	-ON
Suction cup holder		Male thread, 2 nuts, connection on top									-HA			
		Female thread, connection on the side									-HB			
		Male thread, 2 nuts, connection on top, height compensation									-HC			
		Male thread, 2 nuts, connection on top, long height compensation									-HCL			
		Male thread, 2 nuts, connection on the side, height compensation									-HD			
		Male thread, 2 nuts, connection on the side, long height compensation									-HDL			
		External thread, port on top, screw-in thread									-HE			
		Male thread, connection at top, screw-in thread, height compensator									-HF			
Vacuum connection		Push-in connector for plastic tubing								[1]	-QS			
		Barbed fitting connection for plastic tubing								[1]	-PK			
Vacuum filter		Vacuum filter									-F			

[1] QS, PKNot with suction cup holder HE, HF.

Ordering data – Modular product system

Ordering table – Suction cup dimensions 15x45 ... 30x90 mm									
Size (suction cup dimensions)		15x45	20x60	25x75	30x90	Condi- tions	Code	Enter code	
Holder size		5							
Module no.		189189	189190	189191	189192				
Gripper function		Suction gripper						ESG	ESG
Suction cup size [mm]		15x45	20x60	25x75	30x90		-...		
Suction cup shape/suction cup material	Flat	NBR (nitrile rubber)						-ON	-ON
Suction cup holder		Male thread, 2 nuts, connection on top						-HA	
		Female thread, connection on the side						-HB	
		Male thread, 2 nuts, connection on top, height compensation						-HC	
		Male thread, 2 nuts, connection on top, long height compensation						-HCL	
		Male thread, 2 nuts, connection on the side, height compensation						-HD	
		Male thread, 2 nuts, connection on the side, long height compensation						-HDL	
		External thread, port on top, screw-in thread						-HE	
Connection		Threaded connection						-G	