

## Parallel gripper DHPS

**FESTO**



## Characteristics

### At a glance

[Further information → dhps](#)

General information:

- Resilient and precise T-slot guidance of the gripper jaws
- Oval piston for high gripping forces
- High gripping forces with compact dimensions
- Gripper jaw centring options
- Max. repetition accuracy
- Gripping force backup
- Internal fixed flow control
- Wide range of adaptation options on the drives

Sensors:

- Adaptable position sensor for small gripper sizes
- Integrated proximity switches for medium and large gripper sizes

Flexible range of applications:

- Can be used as a double-acting and single-acting gripper
- Compression spring for supporting or retaining the gripping forces
- Suitable for external and internal gripping

These grippers are not designed for the following or similar application examples:

- Machining
- Aggressive media
- Grinding dust
- Welding spatter

### Engineering tools

[Further information → engineering tools](#)



Save time with engineering tools Smart Engineering for the optimal solution. Our goal is to increase your productivity. Our engineering tools play an integral part in this. They help you size your system correctly, tap into unimagined productivity reserves and generate additional productivity along the entire value chain. In every phase of your project, from the initial contact to the modernisation of your machine, you will come across a number of different tools which will be of use to you.

Gripper selection:

- This tool helps you to select the right grippers by simply entering the exact parameters for your application

### Diagrams

[Further information → dhps](#)



The diagrams shown in this document are also available online. These can be used to display precise values.

### Special material properties

Product:

Metals with more than 5% copper by mass are excluded from use. Exceptions are circuit boards, cables, electrical plug connectors and coils

Accessories:

Please contact your Festo representative for information on which accessories are suitable for manufacturing lithium-ion batteries

### Position sensing

[A] For proximity sensor

By using proximity switches, any position can be detected.

## Characteristics

### Gripping force backup

[NC] N/O contact

Closed by spring force in depressurised state

[NO] Opening

Opened by spring force in depressurised state

### Overview

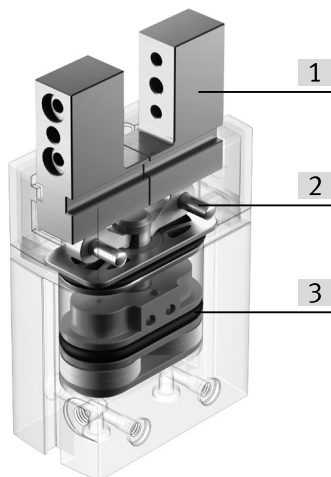

- [1] Gripper jaw
- [2] Reversing lever
- [3] Piston with magnet

Type code

001	Series	
DHPS	Parallel gripper	

002	Size [mm]	
6	6	
10	10	
16	16	
20	20	
25	25	
35	35	

003	Position sensing	
A	For proximity sensor	

004	Gripping force backup	
	None	
NC	N/O contact	
NO	Opening	

## Datasheet

General technical data						
Size	6	10	16	20	25	35
Stroke per gripper jaws	2 mm	3 mm	5 mm	6.5 mm	7.5 mm	12.5 mm
Design	Lever Force pilot operated motion sequence					
Mode of operation	Double-acting					
Gripper force back-up	None	During opening During closing		During opening During closing None		
Gripper function	Parallel					
Guide	Plain-bearing guide					
Number of gripper jaws	2					
Max. mass per external gripper finger <sup>1)</sup>	10 g	60 g	150 g	250 g	350 g	450 g
Pneumatic connection	M3			M5	G1/8	
Repetition accuracy, gripper <sup>2)</sup>	0.02 mm					
Max. replacement accuracy	0.2 mm					
Max. operating frequency of gripper	4 Hz		3 Hz		2 Hz	
Rotationally symmetrical	0.2 mm					
Position detection	Via Hall sensor		Via proximity switch			
Type of mounting	Either: Via female thread and centring sleeve Via through-hole and centring sleeve					
Mounting position	optional					

1) Valid for unthrottled operation

2) Under constant exposure to operating conditions, end-position drift occurs in the direction of movement of the gripper jaws, at 100 consecutive strokes

Operating and environmental conditions						
Size	6	10	16	20	25	35
Operating medium	Compressed air to ISO 8573-1:2010 [7:4:4]					
Note on operating and pilot medium	Lubricated operation possible (in which case lubricated operation will always be required)					
Ambient temperature <sup>1)</sup>	5 ... 60°C					
Corrosion resistance class CRC <sup>2)</sup>	1 - Low corrosion stress					
Lubrication interval for guide components	10 MioCyc					

1) Note the operating range of the proximity switches

2) More information: [www.festo.com/x/topic/crc](http://www.festo.com/x/topic/crc)

Operating pressure – DHPS-6 ... 16							
Size	6	10			16		
Gripping force backup	None	N/O contact		Opening	None	N/O contact	Opening
Operating pressure	0.2 ... 0.8 MPa		0.4 ... 0.8 MPa		0.2 ... 0.8 MPa	0.4 ... 0.8 MPa	
Operating pressure	29 ... 116 psi		58 ... 116 psi		29 ... 116 psi	58 ... 116 psi	
Operating pressure	2 ... 8 bar		4 ... 8 bar		2 ... 8 bar	4 ... 8 bar	

Operating pressure – DHPS-20 ... 35									
Size	20			25			35		
Gripping force backup	None	N/O contact	Opening	None	N/O contact	Opening	None	N/O contact	Opening
Operating pressure	0.2 ... 0.8 MPa	0.4 ... 0.8 MPa		0.2 ... 0.8 MPa	0.4 ... 0.8 MPa		0.2 ... 0.8 MPa	0.4 ... 0.8 MPa	
Operating pressure	29 ... 116 psi	58 ... 116 psi		29 ... 116 psi	58 ... 116 psi		29 ... 116 psi	58 ... 116 psi	
Operating pressure	2 ... 8 bar	4 ... 8 bar		2 ... 8 bar	4 ... 8 bar		2 ... 8 bar	4 ... 8 bar	

Weights – DHPS-6 ... 16							
Size	6	10			16		
Gripping force backup	None	N/O contact		Opening	None	N/O contact	Opening
Product weight	19 g	67 g	68 g		184 g	188 g	

## Datasheet

### Weights – DHPS-20 ... 35

Size	20			25			35		
Gripping force backup	None	N/O contact	Opening	None	N/O contact	Opening	None	N/O contact	Opening
Product weight	380 g	387 g		700 g	713 g		1,285 g	1,345 g	

### Materials

Size	6	10	16	20	25	35
Material housing	Hard anodised wrought aluminium alloy					
Material gripper jaws	High-alloy stainless steel					
Material cover cap	PA					
Note on materials	RoHS-compliant					
LABS (PWIS) conformity	VDMA24364-B2-L					
Suitability for the production of Li-ion batteries	Metals with more than 5% copper by mass are excluded from use. Exceptions are printed circuit boards, cables, electrical plug connectors and coils					

### Measured gripping force with a lever arm of 20 mm

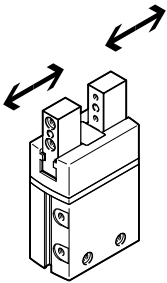

Size	6	10	16	20	25	35
Total gripping force, closing, 0.6MPa (6bar, 87 psi)	25 N	70 N	190 N	290 N	450 N	910 N
Total gripping force, opening, 0.6MPa (6bar, 87 psi)	30 N	80 N	210 N	320 N	500 N	970 N
Gripper force per gripper jaw, closing, 0.6 MPa (6 bar, 87 psi)	13.5 N	34.5 N	96 N	147 N	228 N	450 N
Gripper force per gripper jaw, opening, 0.6 MPa (6 bar, 87 psi)	15 N	39 N	105 N	162 N	249 N	483 N

## Datasheet

### Characteristic load values at the gripper jaws

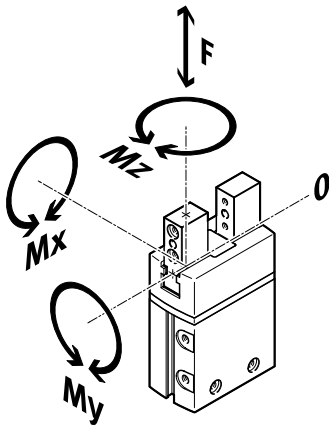

The indicated permissible forces and torques apply to a single gripper jaw. They include the lever arm, additional applied loads created by the workpiece or external gripper fingers and acceleration forces occurring during movement. The zero coordinate line (gripper jaw guide) must be taken into account when calculating torques.

Size	6	10	16	20	25	35
Max. force on gripper jaw Fz static	10 N	60 N	150 N	250 N	350 N	450 N
Max. torque at gripper Mx static	0.5 Nm	3 Nm	8 Nm	14 Nm	30 Nm	50 Nm
Max. torque at gripper My static	0.5 Nm	3 Nm	8 Nm	14 Nm	30 Nm	50 Nm
Max. torque at gripper Mz static	0.5 Nm	3 Nm	8 Nm	14 Nm	30 Nm	50 Nm

### Gripping force FH per gripper jaw as a function of operating pressure and lever arm x

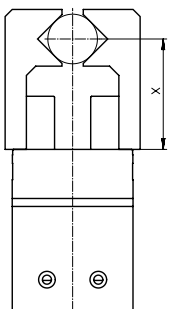

The gripping forces as a function of the operating pressure and lever arm can be determined from the following graphs.

The gripping torque is not constant across the opening angle.

Engineering software for gripper selection → [www.festo.com](http://www.festo.com)

### Gripping force FH per gripper jaw as a function of operating pressure and lever arm x – external gripping (closing), double-acting – DHPS-6

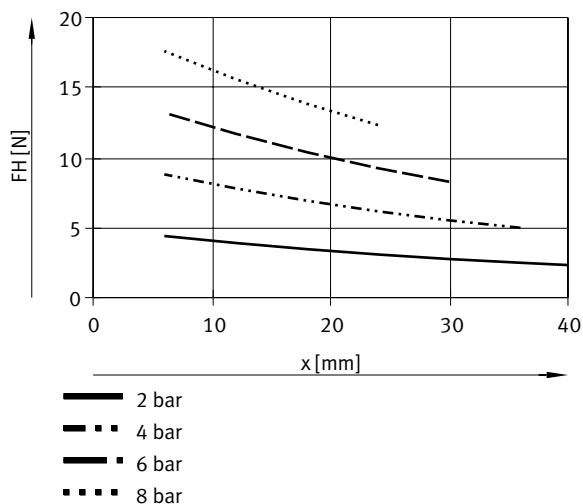

Datasheet

Gripping force FH per gripper jaw as a function of operating pressure and lever arm x – external gripping (closing), double-acting – DHPS-10

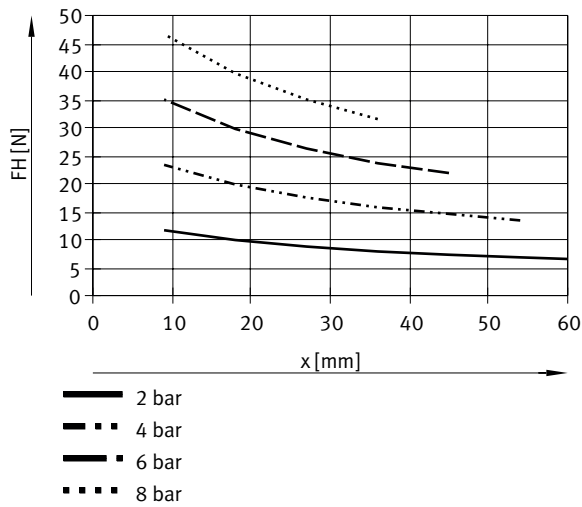

Gripping force FH per gripper jaw as a function of operating pressure and lever arm x – external gripping (closing), double-acting – DHPS-16

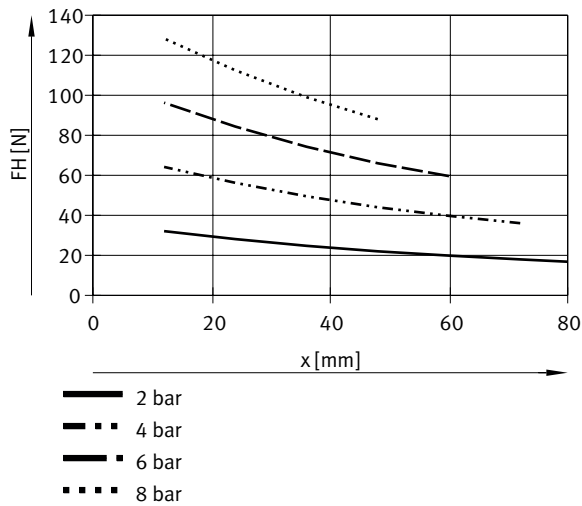



## Datasheet

Gripping force FH per gripper jaw as a function of operating pressure and lever arm x – external gripping (closing), double-acting – DHPS-20

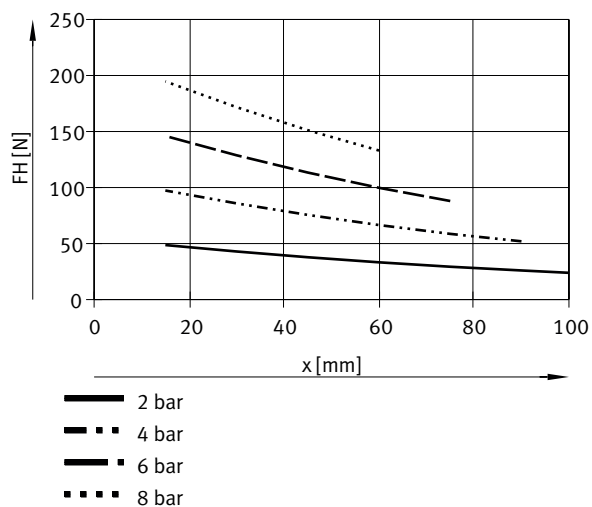

Gripping force FH per gripper jaw as a function of operating pressure and lever arm x – external gripping (closing), double-acting – DHPS-25

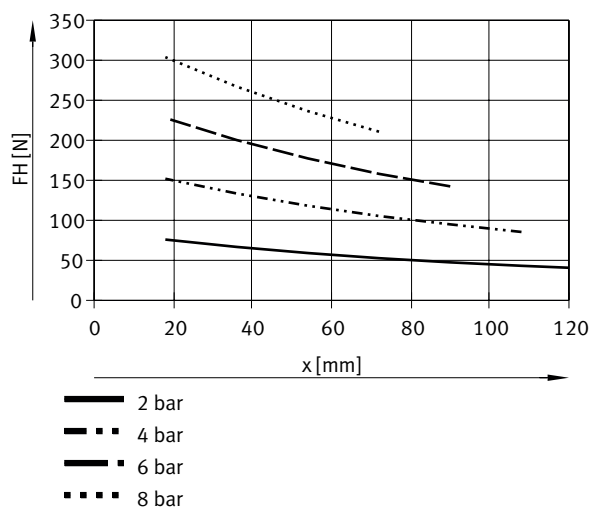

Datasheet

Gripping force FH per gripper jaw as a function of operating pressure and lever arm x – external gripping (closing), double-acting – DHPS-35

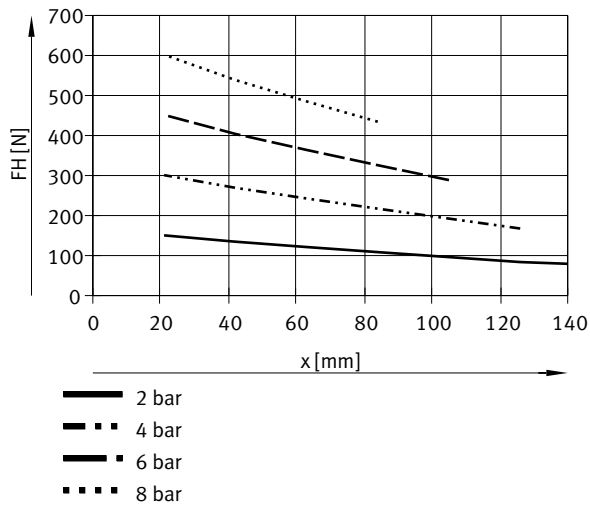

Gripping force FH per gripper jaw as a function of operating pressure and lever arm x – internal gripping (opening), double-acting – DHPS-6

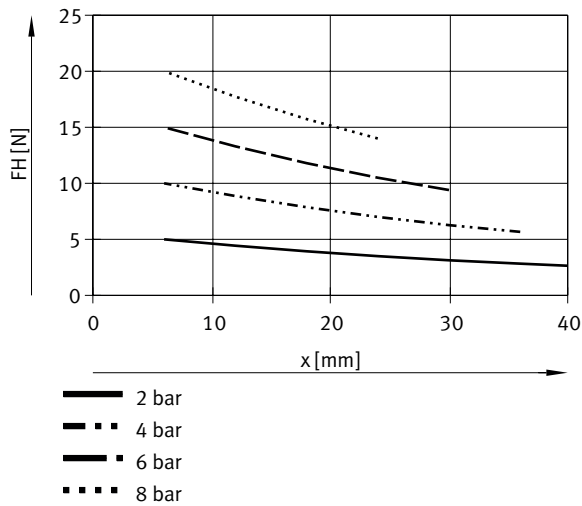

## Datasheet

Gripping force FH per gripper jaw as a function of operating pressure and lever arm x – internal gripping (opening), double-acting – DHPS-10

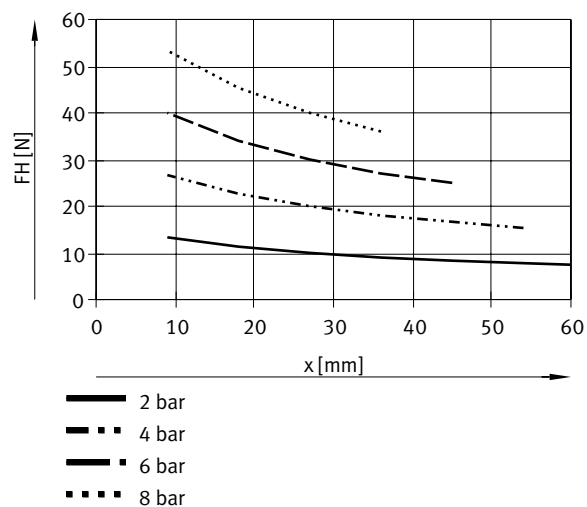

Gripping force FH per gripper jaw as a function of operating pressure and lever arm x – internal gripping (opening), double-acting – DHPS-16

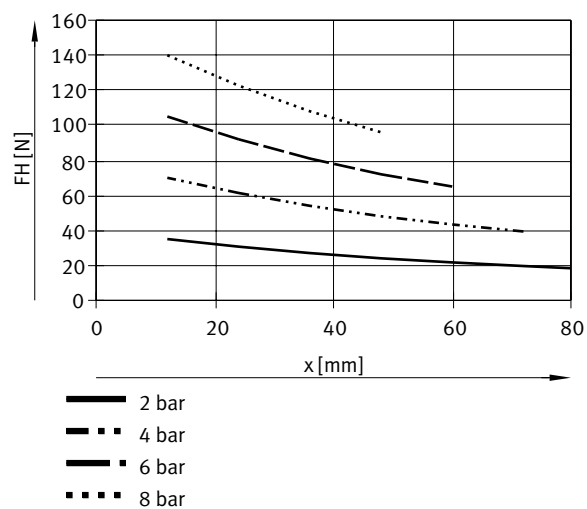

Datasheet

Gripping force FH per gripper jaw as a function of operating pressure and lever arm x – internal gripping (opening), double-acting – DHPS-20

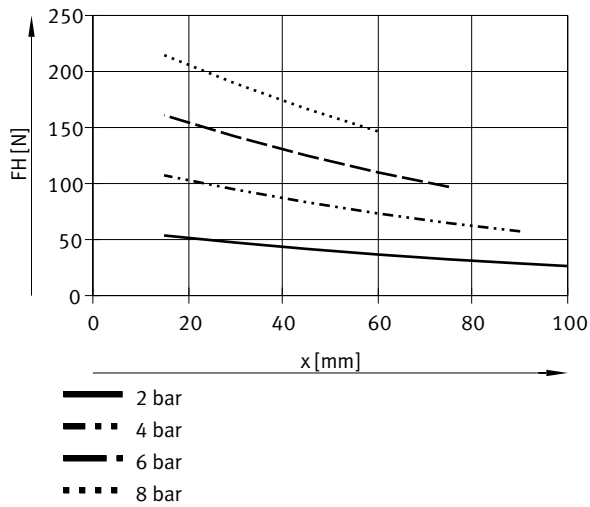

Gripping force FH per gripper jaw as a function of operating pressure and lever arm x – internal gripping (opening), double-acting – DHPS-25

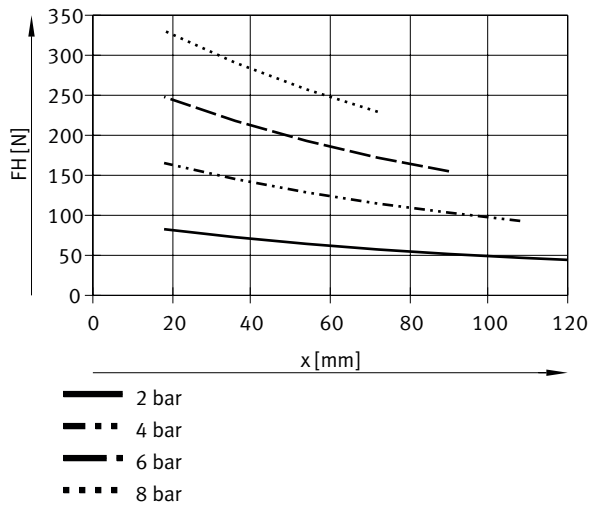

## Datasheet

## Gripping force FH per gripper jaw as a function of operating pressure and lever arm x – internal gripping (opening), double-acting – DHPS-35

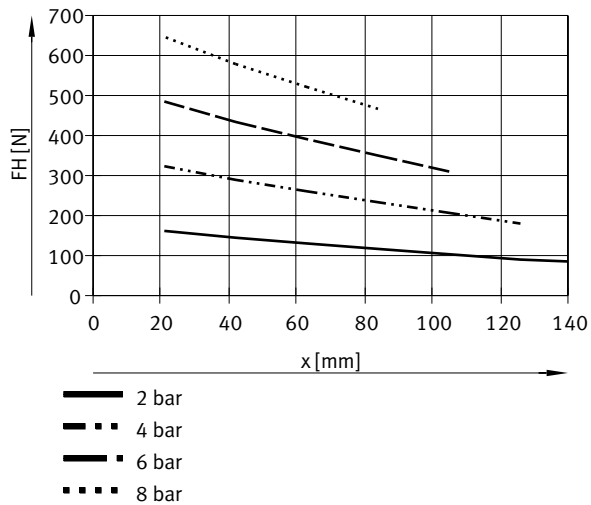

## Gripping force FH per gripper jaw at 0.6 MPa (6 bar, 87 psi) as a function of lever arm x and eccentricity a and b

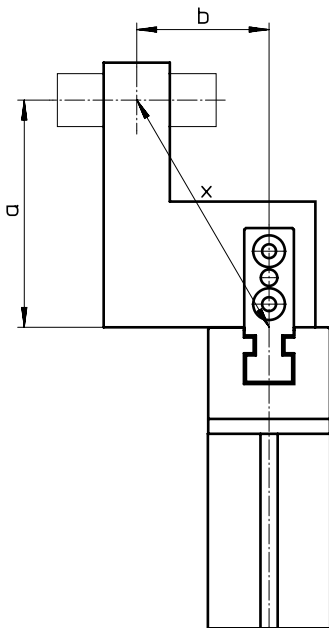

## Gripping force FH per gripper jaw at 0.6 MPa (6 bar, 87 psi) as a function of lever arm x and eccentricity a and b

$$x = \sqrt{a^2 + b^2} = \sqrt{25^2 + 20^2} = 32 \text{ mm}$$

The formula (on the left) must be used to calculate the lever arm x with eccentric gripping.

The gripping force F can then be read from the graphs using the calculated value x.

Calculation example:

Assuming:

Distance a = 25 mm

Distance b = 20 mm

To be determined:

The gripping force at 6 bar, with a DHPS-16 used as an external gripper.

## Datasheet

### Gripping force $F_H$ per gripper jaw at 0.6 MPa (6 bar, 87 psi) as a function of lever arm $x$ and eccentricity $a$ and $b$

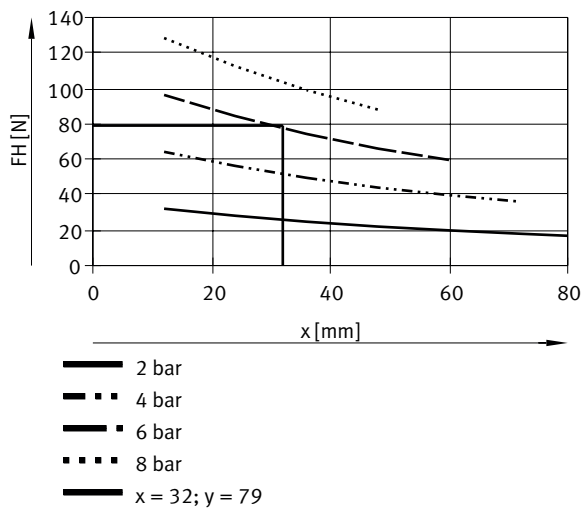

The graph gives a value of  $F = 79$  N for the gripping force.

### Spring force $F$ as a function of the size and the total gripper jaw stroke $l$ – gripping force backup for DHPS-...-N...

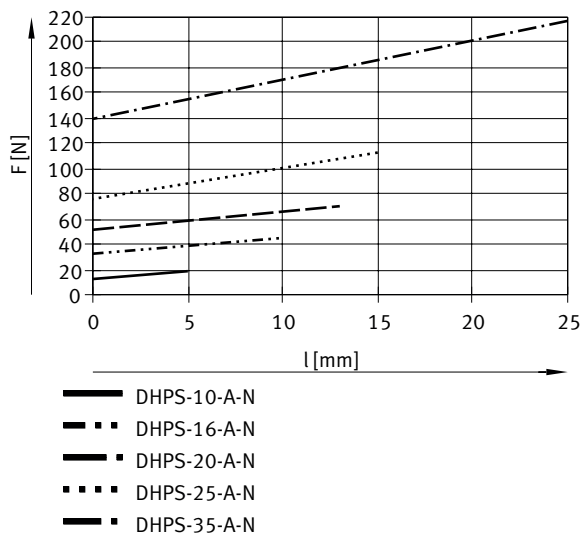

The spring forces  $F$  can be determined from the diagram (left) as a function of the gripper jaw stroke  $l$ .

### Spring force $F$ as a function of size, gripper jaw stroke $l$ and lever arm $x$ per gripper finger

To determine the actual spring force  $F_{tot}$ , the lever arm  $x$  must be taken into account.

Formulas for calculating the spring force  $F_{tot}$  per gripper finger:

DHPS-10:  $-0.02 * x + 0.5 * F$

DHPS-16:  $-0.08 * x + 0.5 * F$

DHPS-20:  $-0.1 * x + 0.5 * F$

DHPS-25:  $-0.12 * x + 0.5 * F$

DHPS-35:  $-0.19 * x + 0.5 * F$

### Determining the actual gripping forces $F_{Gr}$ for DHPS-...-NO and DHPS-...-NC as a function of application

The parallel grippers with integrated spring, type DHPS-...-NO (opening gripping force retention) and DHPS-...-NC (closing gripping force retention) can be used as:

- Single-acting grippers
- Gripper with gripping force support and
- Grippers with gripping force retention

To calculate available gripping forces  $F_{Gr}$  (per gripper jaw), the data for gripping force  $F_H$  and spring force  $F_{tot}$  must be combined accordingly.

## Datasheet

### Determining the actual gripping forces $F_{Gr}$ for DHPS-...-NO and DHPS-...-NC as a function of the application – application

Single-acting:

- Gripping with spring force:  $F_{Gr} = F_{tot}$
- Gripping with pressure force:  $F_{Gr} = F_H - F_{tot}$

Gripping force support:

- Gripping with pressure and spring force:  $F_{Gr} = F_H + F_{tot}$

Gripping force backup

- Gripping with spring force:  $F_{Gr} = F_{tot}$

### Mass moments of inertia – DHPS-6 ... 16

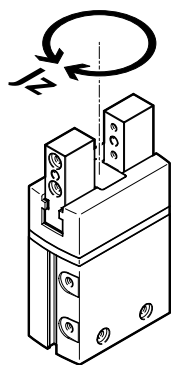

Mass moment of inertia of the parallel gripper in relation to the central axis, without external gripper fingers, without load.

Size	6			10			16		
Gripping force backup	None			N/O contact	Opening		None	N/O contact	Opening
Mass moment of inertia	0.008 kgcm <sup>2</sup>	0.079 kgcm <sup>2</sup>	0.081 kgcm <sup>2</sup>	0.082 kgcm <sup>2</sup>	0.465 kgcm <sup>2</sup>	0.468 kgcm <sup>2</sup>	0.472 kgcm <sup>2</sup>		

### Mass moments of inertia – DHPS-20 ... 35

Size	20			25			35		
Gripping force backup	None	N/O contact	Opening	None	N/O contact	Opening	None	N/O contact	Opening
Mass moment of inertia	1.489 kgcm <sup>2</sup>	1.494 kgcm <sup>2</sup>	1.521 kgcm <sup>2</sup>	3.831 kgcm <sup>2</sup>	3.835 kgcm <sup>2</sup>	3.92 kgcm <sup>2</sup>	12.7 kgcm <sup>2</sup>	12.726 kgcm <sup>2</sup>	12.832 kgcm <sup>2</sup>

### Gripper jaw backlash

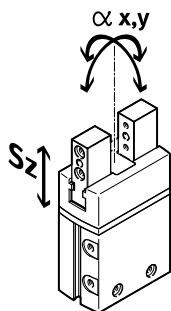

The plain-bearing guide used in the grippers means that there is backlash between the gripper jaws and the housing. The backlash values listed in the table have been calculated based on the traditional accumulative tolerance method.

Size	6	10	16	20	25	35
Max. gripper jaw backlash $S_z$	0.02 mm					
Max. angular gripper jaw backlash $\alpha_x, \alpha_y$	1 deg		0.5 deg			

Datasheet

Opening and closing times – DHPS-6 ... 16

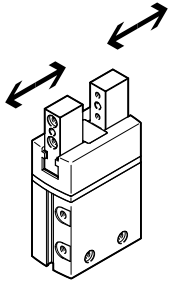

The specified opening and closing times [ms] were measured at room temperature, 0.6 MPa (6 bar, 87 psi) operating pressure and with the gripper installed horizontally without additional gripper fingers. For higher masses [g], the grippers must be throttled. Opening and closing times must then be adjusted accordingly.

Size	6			10		16			
Gripping force backup	None		N/O contact	Opening		None		N/O contact	Opening
Min. closing time at 0.6 MPa (6 bar, 87 psi)	17 ms	28 ms	24 ms	30 ms	41 ms	37 ms	50 ms		
Min. opening time at 0.6 MPa (6 bar, 87 psi)	8 ms	21 ms	58 ms	19 ms	33 ms	48 ms	32 ms		

Opening and closing times – DHPS-20 ... 35

Size	20			25			35				
Gripping force backup	None	N/O contact	Opening		None	N/O contact	Opening		None	N/O contact	Opening
Min. closing time at 0.6 MPa (6 bar, 87 psi)	87 ms	62 ms	97 ms	63 ms	52 ms	78 ms	123 ms	99 ms	151 ms		
Min. opening time at 0.6 MPa (6 bar, 87 psi)	59 ms	72 ms	58 ms	48 ms	68 ms	45 ms	95 ms	131 ms	88 ms		



# Dimensions

Dimensions – Parallel gripper DHPS

Download CAD data → [www.festo.com](http://www.festo.com)

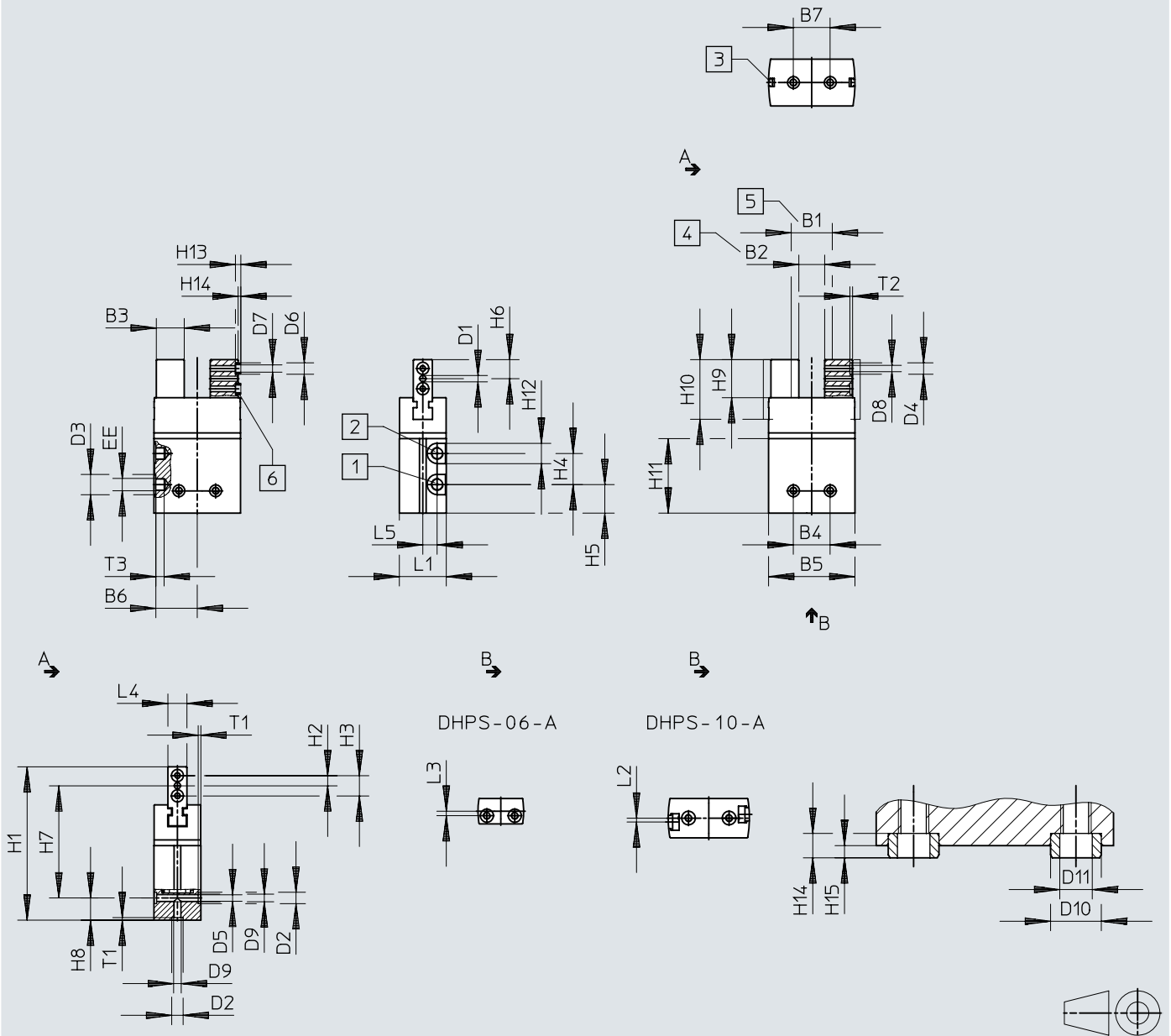

- [1] Open compressed air supply port
- [2] Close compressed air supply port
- [3] Slot for proximity switch
- [4] Initial position for DHPS-...-A and DHPS-...-A-NC
- [5] Initial position for DHPS-...-A-NO
- [6] Centring sleeves ZBH (size 10 and larger: 4 included in the scope of delivery)

## Dimensions

	B1 ±0,5	B2 ±0,5	B3 -0,03	B4 <sup>1)</sup>	B5 ±0,1	B6	B7 <sup>1)</sup>	D1 ∅ H8	D2 ∅ H8	D3 ∅	D4 ∅ H8	D5 ∅ +0,1	D6 ∅ h7	D7 ∅	D8
DHPS-6	10	6	5,5	11	18	8,65	11	1,5	5	7	-	2,5	-	-	M2
DHPS-10	21,8	15,8	7	16	32	15,4	16	2	5	7	5	2,5	5	3,2	M3
DHPS-16	27,8	17,8	13	25	47	22,65	25	3	7	7	7	3,3	7	5,3	M4
DHPS-20	30	17	17,5	25	55,6	26,25	25	4	7	10	7	3,3	7	5,3	M4
DHPS-25	35,4	20,4	22	29	68,2	32,65	29	4	9	16	9	5,1	9	6,4	M5
DHPS-35	56	31	27	33	88	42,25	33	5	12	16	9	6,4	9	6,4	M6

	D9	D10 ∅ h7	D11 ∅	EE	H1	H2	H3 <sup>1)</sup>	H4	H5	H6	H7 ±0,2	H8 <sup>2)</sup>	H9	H10	H11
DHPS-6	M3	-	-	M3	45,5	2,9	5,8	15	4	5	33	7,5	9,55	15,8	25,3
DHPS-10	M3	5	3,2	M3	66	4	8	15,5	10,5	7,5	51	7,5	15,2	23	35
DHPS-16	M4	7	5,3	M3	80	5,5	11	18	11	10	62,5	7,5	20	32,5	38,1
DHPS-20	M4	7	5,3	M5	101	7	14	23	16	12,5	81	7,5	25	39,5	50
DHPS-25	M6	9	6,4	G1/8	121	8	16	24,5	22,5	15	88,5	17,5	30	47	58,8
DHPS-35	M8	9	6,4	G1/8	142	8,5	17	29	24	16	108,5	17,5	32	53	65,3

	H12	H13 -0,2	H14			H15 -0,3	L1	L2	L3 <sup>1)</sup>	L4 -0,05	L5	T1 +0,1	T2 +0,1	T3 +0,5
			[ZBH-5] -0,3	[ZBH-7] -0,2	[ZBH-9] -0,2									
DHPS-6	7	-	-	-	-	-	10 <sup>+0,1</sup>	-	1,8	5	1,5	1,2	-	3,5
DHPS-10	7	2,4	1,2	2,4	-	-	15,5 <sup>+0,1</sup>	1,5	-	7	5	1,2	1,2	5
DHPS-16	7	3	1,4	-	3	-	22 <sup>+0,1</sup>	-	-	10	7	1,6	1,6	6
DHPS-20	10	3	1,4	-	3	-	30±0,1	-	-	12	9	1,6	1,6	6
DHPS-25	16	4	1,9	-	-	4	37±0,1	-	-	15	11,3	2,1	2,1	6,5
DHPS-35	16	4	1,9	-	-	4	45 <sup>+0,1</sup>	-	-	20	13,5	2,6	2,1	6,5

1) Tolerance for centring hole ±0.02 mm / Tolerance for thread ±0.1 mm

2) Tolerance for centring hole ±0.05 mm / tolerance for thread ±0.1 mm

## Dimensions

### Dimensions – Sensor rail HGP-SL

Download CAD data → [www.festo.com](http://www.festo.com)

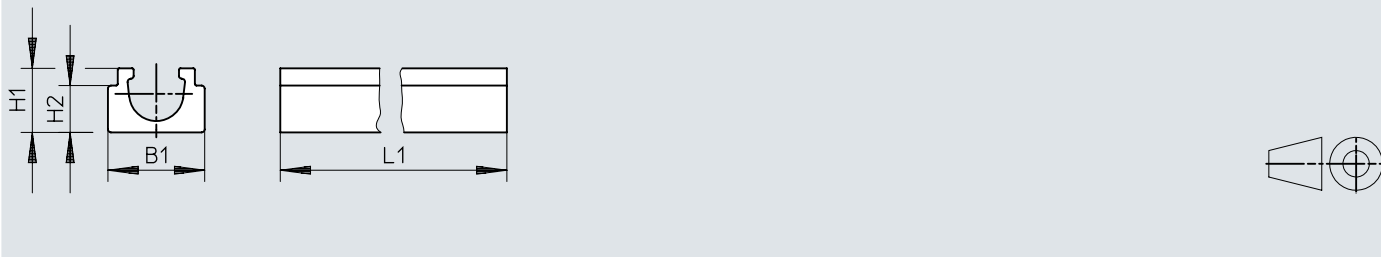

	B1 +0,05	H1 +0,05/-0,1	H2 -0,1	L1
HGP-SL-10-10				35
HGP-SL-10-16				38
HGP-SL-10-20	4,25	3,1	6,4	50
HGP-SL-10-25				58
HGP-SL-10-35				65

## Ordering data

Double-acting, without compression spring					
	Size	Stroke per gripper jaws	Product weight	Part no.	Type
	6	2 mm	19 g	★ 1254039	DHPS-6-A
	10	3 mm	67 g	★ 1254040	DHPS-10-A
	16	5 mm	184 g	★ 1254043	DHPS-16-A
	20	6.5 mm	380 g	★ 1254046	DHPS-20-A
	25	7.5 mm	700 g	★ 1254049	DHPS-25-A
	35	12.5 mm	1,285 g	★ 1254052	DHPS-35-A

Single-acting or with gripping force retention, opening					
	Size	Stroke per gripper jaws	Product weight	Part no.	Type
	10	3 mm	68 g	1254041	DHPS-10-A-NO
	16	5 mm	188 g	1254044	DHPS-16-A-NO
	20	6.5 mm	387 g	1254047	DHPS-20-A-NO
	25	7.5 mm	713 g	1254050	DHPS-25-A-NO
	35	12.5 mm	1,345 g	1254053	DHPS-35-A-NO

Single-acting or with closing gripping force retention					
	Size	Stroke per gripper jaws	Product weight	Part no.	Type
	10	3 mm	68 g	1254042	DHPS-10-A-NC
	16	5 mm	188 g	1254045	DHPS-16-A-NC
	20	6.5 mm	387 g	1254048	DHPS-20-A-NC
	25	7.5 mm	713 g	1254051	DHPS-25-A-NC
	35	12.5 mm	1,345 g	1254054	DHPS-35-A-NC

Peripherals

DHPS-6

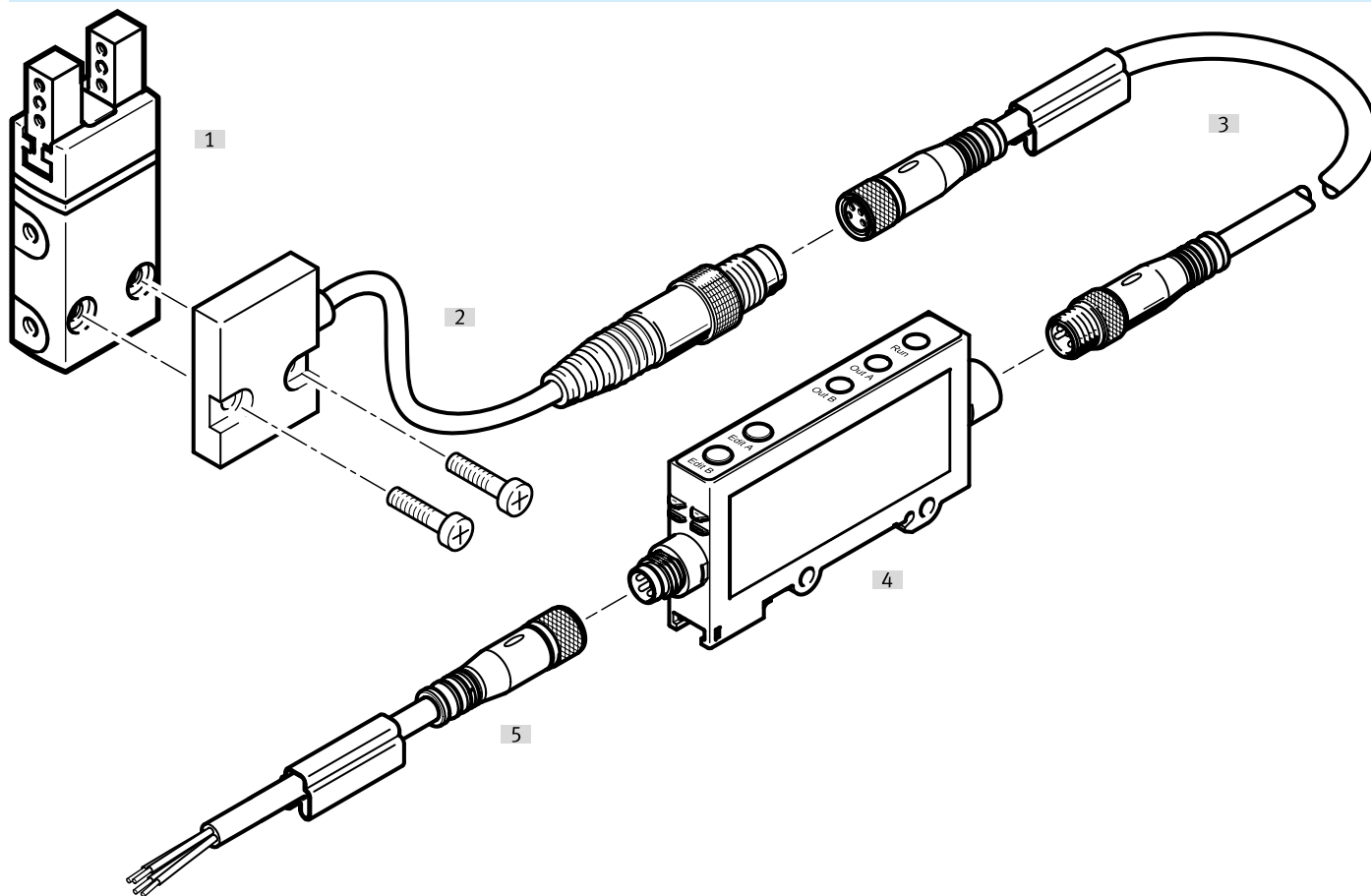

Accessories			→ Page/Internet
Type/order code	Description		
[1] Parallel gripper DHPS	Double-acting		dhps
[2] Position sensor SMH-S1	Adaptable and integrable sensors for sensing the piston position		23
[3] Connecting cable NEBU	Connection between position sensor and signal converter		24
[4] Signal converter SVE4	For evaluating signals for position sensor SMH-S1		24
[5] Connecting cable NEBU	Connection between signal converter and controller		26
[6] Adapter kit DHAA, HAPG	Connecting plate between drive and gripper		adapter
[7] Proportional-pressure regulator VPPM	For stepless adjustment of the gripping force		vppm

Peripherals

DHPS-10 ... 35

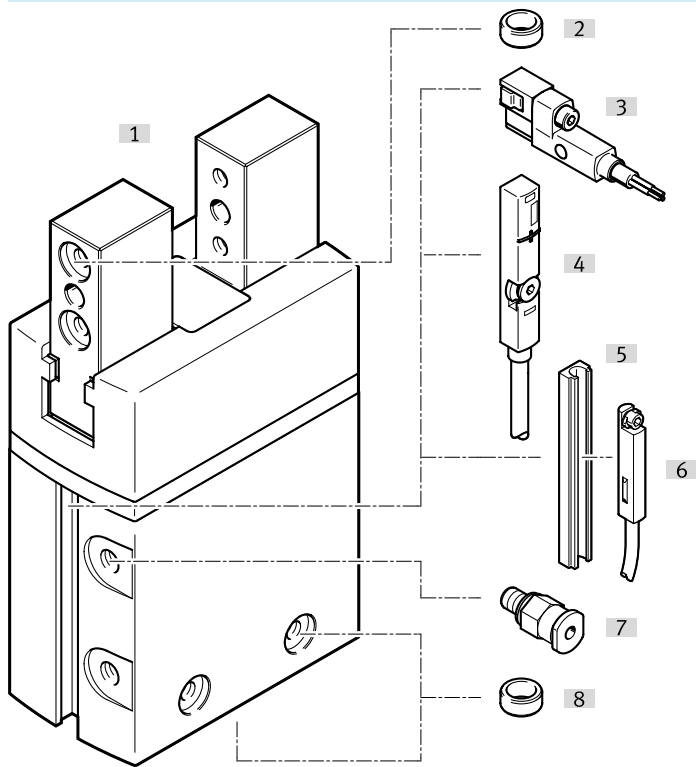

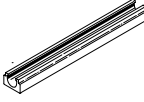

Accessories		→ Page/Internet
Type/order code	Description	
[1] Parallel gripper DHPS	Double-acting	dhps
[2] Centring sleeve ZBH	- For centring the gripper fingers on the gripper jaws - 4 centring sleeves are included in the scope of delivery of the gripper from size 10 onward	23
[3] Proximity switch SMT-8G	- For sensing the piston position - Proximity switch does not protrude underneath the housing	24
[4] Position transmitter SMAT-8M	Continuously detects the position of the piston. It has an analogue output with an output signal that is proportional to the piston position	25
[4] Position transmitter SDAT	Continuously detects the position of the piston. It has an analogue output with an output signal proportional to the piston position	25
[5] Glue-in sensor rail HGP-SL	Enables the use of proximity switches SME/SMT-10	23
[6] Proximity switch SMT-10G	- For sensing the piston position - Proximity switch does not protrude underneath the housing - With sensor rail HGP-SL10-...	25
[7] Push-in fitting QS	For connecting tubing with standard O.D.	qs
[8] Centring sleeve ZBH	- For centring the gripper when mounting - 2 centring sleeves are included in the scope of delivery of the gripper	23
[9] Adapter kit DHAA, HAPG	Connecting plate between drive and gripper	adapter
[10] Proportional-pressure regulator VPPM	For stepless adjustment of the gripping force	vppm

## Accessories

Sensor rail HGP-SL						
	Description	Material adhesive	Part no.	Type		
	For size 10	Construction adhesive	535582	HGP-SL10-10		
	For size 16		535583	HGP-SL10-16		
	For size 20		535584	HGP-SL10-20		
	For size 25		535585	HGP-SL10-25		
	For size 35		535586	HGP-SL10-35		

Centring sleeve ZBH-5						
	Description	Material sleeve	Size of pack	Product weight	Part no.	Type
	For sizes 6, 10	Steel	10	1 g	8146543	ZBH-5-B

Centring sleeve ZBH-7						
	Description	Material sleeve	Size of pack	Product weight	Part no.	Type
	For sizes 16, 20	Steel	10	1 g	8146544	ZBH-7-B

Centring sleeve ZBH-9						
	Description	Material sleeve	Size of pack	Product weight	Part no.	Type
	For sizes 25, 35	Steel	10	2 g	8137184	ZBH-9-B

Centring sleeve ZBH-12						
	Description	Material sleeve	Size of pack	Product weight	Part no.	Type
	For size 35	Steel	10	1 g	8137185	ZBH-12-B

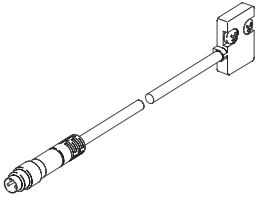
Position sensor SMH-S1 for direct mounting, magnetic Hall – for size 6						Further information → smh
	Type of mounting <sup>1)</sup>	Output signal	Electrical connection	Cable length	Part no.	Type
	Screwed to gripper	Analogue	Plug M8, A-coded	0.5 m	175710	SMH-S1-HGP06

1) Installation note: To ensure the functionality of the position sensor, the cable outlet and the outlet of the compressed air tube must point in the same direction during installation.

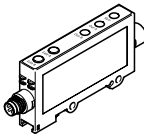
Signal converter SVE4 – for size 6					Further information → sve	
	analog input	Electrical connection (signal input)	Electrical connection (switching output)	Switching output	Part no.	Type
	Adapted for position sensors SMH-S1-HG	Socket M8x1, 4-pin	Plug M8x1, 4-pin	2xNPN	544219	SVE4-HS-R-HM8-2N-M8

## Accessories

### Signal converter SVE4 – for size 6

Further information → sve

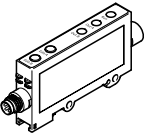
	analog input	Electrical connection (signal input)	Electrical connection (switching output)	Switching output	Part no.	Type
	Adapted for position sensors SMH-S1-HG	Socket M8x1, 4-pin	Plug M8x1, 4-pin	2xPNP	<b>544216</b>	<b>SVE4-HS-R-HM8-2P-M8</b>

### Connecting cables NEBU, straight – connection between position sensor and signal converter

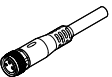
	Electrical connection 1, connector system	Electrical connection 2, connector system	Electrical connection 2, number of connections/cores	Cable length	Part no.	Type
	M8x1, A-coded, to EN 61076-2-104	M8x1, A-coded to EN 61076-2-104	4	2.5 m	<b>554035</b>	<b>NEBU-M8G4-K-2.5-M8G4</b>

### Connecting cables NEBU, straight – connection between signal converter and controller

	Electrical connection 1, connector system	Electrical connection 2, connector system	Electrical connection 2, number of connections/cores	Cable length	Part no.	Type
	M8x1, A-coded, to EN 61076-2-104	Open end	4	2.5 m	<b>541342</b>	<b>NEBU-M8G4-K-2.5-LE4</b>
				5 m	<b>541343</b>	<b>NEBU-M8G4-K-5-LE4</b>

### Connecting cables NEBU, angled – connection between signal converter and controller

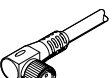
	Electrical connection 1, connector system	Electrical connection 2, connector system	Electrical connection 2, number of connections/cores	Cable length	Part no.	Type
	M8x1, A-coded, to EN 61076-2-104	Open end	4	2.5 m	<b>541344</b>	<b>NEBU-M8W4-K-2.5-LE4</b>
				5 m	<b>541345</b>	<b>NEBU-M8W4-K-5-LE4</b>

### Proximity switch SMT-8G for T-slot, magneto-resistive – for sizes 10 ... 35

Further information → smt

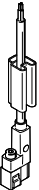
	Type of mounting	Switching output	Electrical connection	Cable length	Part no.	Type
	Clamped in T-slot, Insertable in the slot lengthwise	3-wire NPN N/O contact	Open end	2.5 m	<b>8065028</b>	<b>SMT-8G-NS-24V-E-2,5Q-OE</b>
			Plug M8, A-coded	0.3 m	<b>8065027</b>	<b>SMT-8G-NS-24V-E-0,3Q-M8D</b>
		3-wire PNP N/O contact	Open end	2.5 m	<b>547859</b>	<b>SMT-8G-PS-24V-E-2,5Q-OE</b>
			Plug M8, A-coded	0.3 m	<b>547860</b>	<b>SMT-8G-PS-24V-E-0,3Q-M8D</b>



## Accessories

Proximity switch SMT-10G for round slot, magneto-resistive – For sizes 10 ... 35, with sensor rail HGP-SL10-...						Further information → smt
	Type of mounting	Switching output	Electrical connection	Cable length	Part no.	Type
	Clamped in C-slot, Insertable in the slot lengthwise	3-wire NPN N/O contact	Open end	2.5 m	<b>8065030</b>	<b>SMT-10G-NS-24V-E-2,5Q-OE</b>
			Plug M8, A-coded	0.3 m	<b>8065029</b>	<b>SMT-10G-NS-24V-E-0,3Q-M8D</b>
		3-wire PNP N/O contact	Open end	2.5 m	<b>547862</b>	<b>SMT-10G-PS-24V-E-2,5Q-OE</b>
			Plug M8, A-coded	0.3 m	<b>547863</b>	<b>SMT-10G-PS-24V-E-0,3Q-M8D</b>

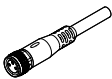
Connecting cable NEBU, straight						
	Electrical connection 1, connector system	Electrical connection 2, connector system	Electrical connection 2, number of connections/cores	Cable length	Part no.	Type
	M8x1, A-coded, to EN 61076-2-104	Open end	3	2.5 m	<b>541333</b>	<b>NEBU-M8G3-K-2.5-LE3</b>
				5 m	<b>541334</b>	<b>NEBU-M8G3-K-5-LE3</b>

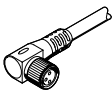
Connecting cable NEBU, angled						
	Electrical connection 1, connector system	Electrical connection 2, connector system	Electrical connection 2, number of connections/cores	Cable length	Part no.	Type
	M8x1, A-coded, to EN 61076-2-104	Open end	3	2.5 m	<b>541338</b>	<b>NEBU-M8W3-K-2.5-LE3</b>
				5 m	<b>541341</b>	<b>NEBU-M8W3-K-5-LE3</b>

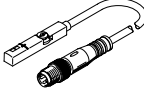
Position transmitter SMAT-8M for T-slot, plug M8, A-coded – for size 10 ... 35						Further information → smat
	Sensing range	Analogue output	Electrical connection 1, number of connections/cores	Cable length	Part no.	Type
	52 mm	0 - 10 V	4	0.3 m	<b>553744</b>	<b>SMAT-8M-U-E-0,3-M8D</b>

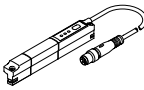
Position transmitter SDAT for T-slot, M8 plug, A-coded – For size 35						Further information → sdat
	Sensing range	Analogue output	Electrical connection 1, number of connections/cores	Cable length	Part no.	Type
	0 ... 50.000 mm	4 - 20 mA	4	0.3 m	<b>1531265</b>	<b>SDAT-MHS-M50-1L-SA-E-0.3-M8</b>

## Accessories

### Connecting cables NEBU, straight

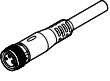
	Electrical connection 1, connector system	Electrical connection 2, connector system	Electrical connection 2, number of connections/cores	Cable length	Part no.	Type
	M8x1, A-coded, to EN 61076-2-104	Open end	4	2.5 m	541342	NEBU-M8G4-K-2.5-LE4
				5 m	541343	NEBU-M8G4-K-5-LE4

### Connecting cables NEBU, angled

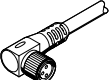
	Electrical connection 1, connector system	Electrical connection 2, connector system	Electrical connection 2, number of connections/cores	Cable length	Part no.	Type
	M8x1, A-coded, to EN 61076-2-104	Open end	4	2.5 m	541344	NEBU-M8W4-K-2.5-LE4
				5 m	541345	NEBU-M8W4-K-5-LE4